



HUSQVARNA AUTOMOWER®
310/315
OPERATOR'S MANUAL







1 Introduction and safety	3		
1.1 Introduction	3	9.1 Fault messages	74
1.2 Symbols on the product	4	9.2 Info messages	77
1.3 Symbols in the Operator's Manual	6	9.3 Indicator lamp in the charging station	78
1.4 Safety instructions	6	9.4 Symptoms	79
		9.5 Finding breaks in the loop wire	80
2 Presentation	10	10 Technical Data	84
2.1 What is what?	11	11 Guarantee terms	85
2.2 Package content	12	12 Environmental information	86
2.3 Function	12	12.1 Removing the battery for recycling	86
3 Installation	16	13 EC Declaration of Conformity	88
3.1 Preparations	16		
3.2 Installation of the charging station	17		
3.3 Charging the battery	21		
3.4 Installation of the boundary wire	22		
3.5 Connecting the boundary wire	28		
3.6 Installation of the guide wire	29		
3.7 Checking the installation	32		
3.8 First start-up and calibration	33		
3.9 Test docking with the charging station	33		
4 Use	34		
4.1 Charging a flat battery	34		
4.2 Using the timer	35		
4.3 Standby	36		
4.4 Starting	37		
4.5 Stopping	37		
4.6 Switching off	37		
4.7 Adjusting the cutting height	38		
5 Control panel	39		
5.1 Operation selection Start	40		
5.2 Operation selection Parking	41		
5.3 Main switch	41		
6 Menu functions	42		
6.1 Main menu	42		
6.2 Menu structure	43		
6.3 Timer	44		
6.4 Security	46		
6.5 Messages	48		
6.6 Weather timer	49		
6.7 Installation	50		
6.8 Settings	59		
6.9 Accessories	63		
7 Garden examples	64		
8 Maintenance	69		
8.1 Winter storage	69		
8.2 Winter service	70		
8.3 After winter storage	71		
8.4 Cleaning	71		
8.5 Transport and moving	72		
8.6 In the event of a thunderstorm	72		
8.7 Blades	73		
8.8 Battery	73		
9 Troubleshooting	74		





MEMO

Serial number: _____

PIN code: _____

Dealer: _____

Dealer's
telephone number: _____

If the robotic lawnmower is stolen, it is important to notify Husqvarna AB of this. Contact your local dealer and provide the product's serial number so that it can be registered as stolen in an international database. This is an important step in the robotic lawnmower's theft protection which reduces interest in the buying and selling of stolen robotic lawnmowers.

The product's serial number consists of nine digits and is shown on the product rating plate (found on the inside of the display cover) and the product's packaging.

www.automower.com

1 Introduction and safety

1.1 Introduction

Congratulations on your choice of an exceptionally high quality product. To get the best results from your Husqvarna robotic lawnmower requires knowledge of how it works. This Operator's Manual contains important information about the robotic lawnmower, how it must be installed and how to use it.

As a complement to this Operator's Manual, there is more information available on the Automower® website, www.automower.com. Here you can find more help and guidance in its use.

Keep in mind that the operator is responsible for accidents or hazards occurring to other people or their property.

Husqvarna AB has a policy of continuous product development and therefore reserves the right to modify the design, appearance and function of products without prior notice.

The following system is used in the Operator's Manual to make it easier to use:

- Text written in *italics* is a text that is shown on the robotic lawnmower's display or is a reference to another section in the Operator's Manual.
- Words written in **bold** are one of the buttons on the robotic lawnmower's keypad.
- Words written in *UPPERCASE* and *italics* refer to the position of the main switch and the different operating modes available in the robotic lawnmower.

www.automower.com



1001-003

IMPORTANT INFORMATION

Please read the Operator's Manual carefully and make sure you understand the instructions before using the robotic lawnmower. Keep the Operator's manual in a safe way for future reference!

This appliance is not intended for use by persons (including children) with reduced physical, sensory or mental capabilities, or lack of experience and knowledge, unless they have been given supervision or instruction concerning use of the appliance by a person responsible for their safety. Children should be supervised to ensure that they do not play with the appliance.

INTRODUCTION AND SAFETY

IMPORTANT INFORMATION

This appliance can be used by children aged from 8 years and above and persons with reduced physical, sensory or mental capabilities or lack of experience and knowledge if they have been given supervision or instruction concerning use of the appliance in a safe way and understand the hazards involved.

Children shall not play with the appliance. Cleaning and user maintenance shall not be made by children without supervision.



WARNING

The robotic lawnmower can be dangerous if used incorrectly.



WARNING

Never use the robotic lawnmower when persons, especially children, or pets, are in the cutting area.

1.2 Symbols on the product

These symbols can be found on the robotic lawnmower. Study them carefully.

- Please read the Operator's Manual carefully and make sure you understand the instructions before using the robotic lawnmower. The warnings and safety instructions in this Operator's Manual must be carefully followed if the robotic lawnmower is to be used safely and efficiently.
- The robotic lawnmower can only start when the main switch is set to 1 and the correct PIN code has been entered. Turn the main switch to 0 before carrying out any inspections and/or maintenance.
- Remain at a safe distance from the robotic lawnmower when it is running. Keep your hands and feet away from the rotating blades.

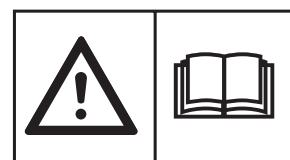

1001-002, 1001-003

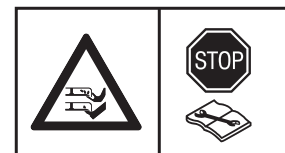

3012-663, 3012-1085

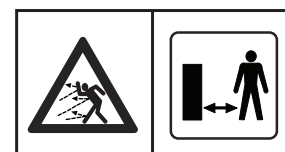

3018-066

INTRODUCTION AND SAFETY

- Never put your hands or feet close to or under the body when the robotic lawnmower is running. Do not ride on the robotic lawnmower.



3012-665

- This product conforms to the applicable EC Directives.



6001-024

- Noise emission to surroundings. The product's emissions are set out in chapter 10, *Technical data* and on the rating plate.



3012-1059

- It is not permitted to dispose of this product as normal household waste when it has reached the end of its useful life. Ensure that the product is recycled in accordance with local legal requirements.



3012-689

- Never use a high-pressure washer or even running water to clean the robotic lawnmower.

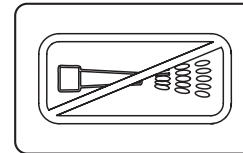

3018-062

- The chassis contains components which are sensitive to electrostatic discharge (ESD). The chassis is also a significant part of the robotic lawnmower's design and must be resealed in a professional manner if the product is to be used outdoors. For this reason the chassis can only be opened by authorized service technicians. A broken seal can result in the entire or parts of the guarantee no longer being valid.



3012-1097

- The low voltage cable must not be shortened, extended or spliced.
- Do not use a trimmer nearby the low voltage cable. Be careful when trimming edges where the cables are placed.

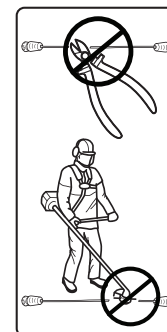

3012-1351



INTRODUCTION AND SAFETY

1.3 Symbols in the Operator's Manual

These symbols can be found in the Operator's Manual. Study them carefully.

- Turn the main switch to 0 before carrying out any inspections and/or maintenance.
- Always wear protective gloves when working with the robotic lawnmower's chassis.
- Never use a high-pressure washer or even running water to clean the robotic lawnmower.
- A warning box indicates the risk of personal injury, especially if the instructions are not followed.
- An information box indicates the risk of material damage, especially if the instructions are not followed. The box is also used where there is a risk of user error.

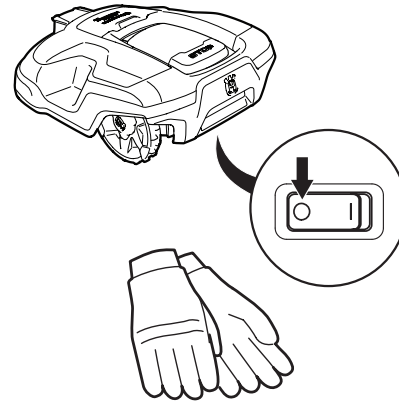

3012-1301

3012-272

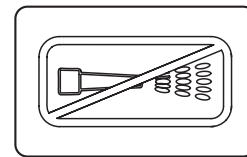

3018-062

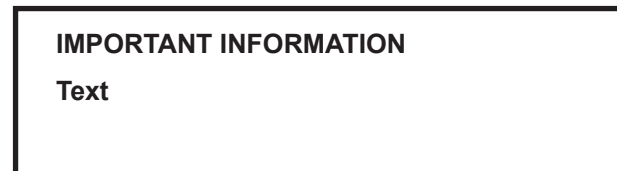
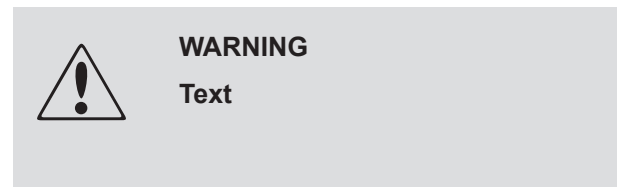

1.4 Safety instructions

Use

- This robotic lawnmower is designed to mow grass in open and level ground areas. It may only be used with the equipment recommended by the manufacturer. All other types of use are incorrect. The manufacturer's instructions with regard to operation/maintenance and repair must be followed precisely.
- Use the **PARK** function or switch off the main switch on the robotic lawnmower when persons, especially children, or pets, are in the cutting area. If there are persons, or pets, in the cutting area it is recommended that the lawnmower be programmed for use during hours when the area is free from persons, e.g. at night. See 6.3 *Timer on page 43*.



1001-003



INTRODUCTION AND SAFETY

- The robotic lawnmower may only be operated, maintained, and repaired by persons that are fully conversant with its special characteristics and safety regulations. Please read the Operator's Manual carefully and make sure you understand the instructions before using the robotic lawnmower.
- It is not permitted to modify the original design of the robotic lawnmower. All modifications are made at your own risk.
- Check that there are no stones, branches, tools, toys or other objects on the lawn that can damage the blades. Objects on the lawn can also lead to the robotic lawnmower getting stuck in them and help may be required to remove the object before the mower can continue mowing.
- Start the robotic lawnmower according to the instructions. When the main switch is set to 1; make sure to keep your hands and feet away from the rotating blades. Never put your hands and feet under the robotic lawnmower.
- Never lift up the robotic lawnmower or carry it around when the main switch is in position 1.
- Do not let persons who do not know how the robotic lawnmower works and behaves use it.
- The robotic lawnmower must never be allowed to collide with persons or other living creatures. If a person or other living creature comes in the lawnmower's way it shall be stopped immediately. See *4.5 Stopping on page 35*.
- Do not put anything on top of the robotic lawnmower or its charging station.
- Do not allow the robotic lawnmower to be used with a defective blade disc or body. Neither should it be used with defective blades, screws, nuts or wires.
- Do not use the robotic lawnmower if the main switch does not work.
- Always switch off the robotic lawnmower using the main switch when the robotic lawnmower is not in use. The robotic lawnmower can only start when the main switch is set to 1 and the correct PIN code has been entered.
- The robotic lawnmower must never be used at the same time as a sprinkler. Use the timer function (see *6.3 Timer on page 43*) so the mower and sprinkler never run simultaneously.
- Husqvarna AB does not guarantee full compatibility between the robotic lawnmower and other types of wireless systems such as remote controls, radio transmitters, hearing loops, underground electric animal fencing or similar.
- The built-in alarm is very loud. Be careful, especially if the robotic lawnmower is handled indoors.

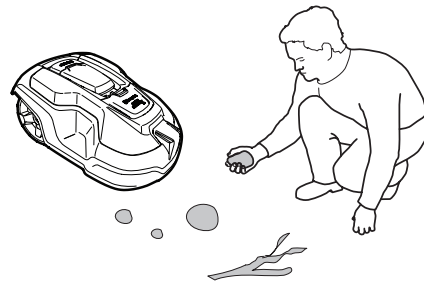

3012-1302



3012-663



INTRODUCTION AND SAFETY

Moving

The original packaging should be used when transporting the robotic lawnmower over long distances.

To safely move from or within the working area:

1. Press the **STOP** button to stop the robotic lawnmower. If security is set to the medium or high level (see 6.4 Security on page 46) the PIN code has to be entered. The PIN code has four digits and is chosen when the robotic lawnmower is started for the first time, see 3.8 First start-up and calibration on page 33.
2. Set the main switch to position 0.
3. Carry the robotic lawnmower by the handle found at the rear of the product. Carry the robotic lawnmower with the blade disc away from the body.

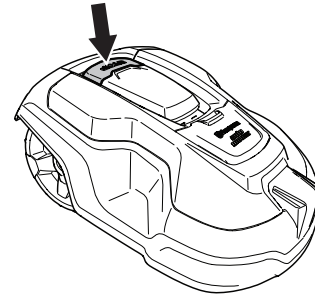

3012-1381

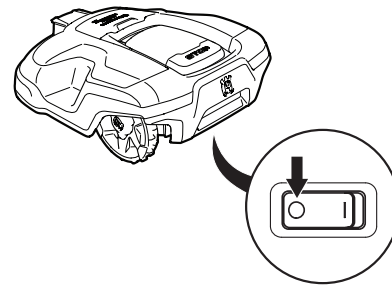

3012-1301

IMPORTANT INFORMATION

Do not lift the robotic lawnmower when it is parked in the charging station. It can damage the charging station and/or the robotic lawnmower. Press STOP and instead first pull the robotic lawnmower out of the charging station before lifting it.

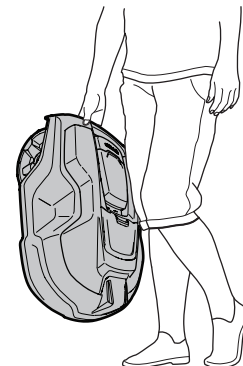

3012-1307



INTRODUCTION AND SAFETY

Maintenance



WARNING

When the robotic lawnmower is turned upside down the main switch must always be in the 0 position.

The main switch should be set in the 0 position during all work on the mower's chassis, such as cleaning or replacing the blades.

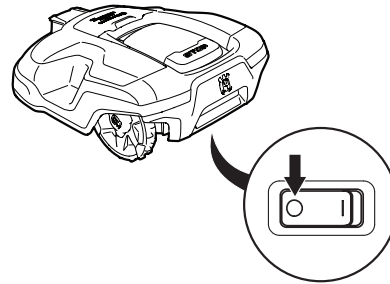

3012-1301

IMPORTANT INFORMATION

Never use a high-pressure washer or even running water to clean the robotic lawnmower. Never use solvents for cleaning.

Inspect the robotic lawnmower each week and replace any damaged or worn parts. The following must be carried out in the weekly inspections:

- Clean the charging station from grass, leaves, twigs and other objects that may impede the robotic lawnmower from docking with the charging station.
- Set the main switch to position 0 and put on a pair of protective gloves. Turn the robotic lawnmower upside down. Check the following:
 1. Clean the drive wheels. Grass in the drive wheels can impact on how the lawnmower works on slopes.
 2. Clean the front wheels. Grass on the front wheels and the front wheel axles can affect performance.
 3. Clean the body, chassis and cutting system. Grass, leaves and other objects that weigh down the product affect performance.
 4. Check that all mower blades are intact. Check also that the mower blades can pivot freely. Even if the mower blades are intact, they must be replaced on a regular basis for the best mowing result and low energy usage. Replace all blades and screws at the same time if necessary so that the rotating parts are kept balanced.
See 8.7 Blades on page 73.

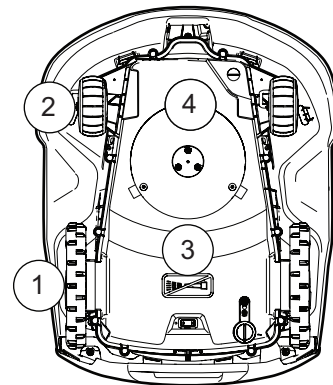

3012-1304

PRESENTATION

2 Presentation

This chapter contains information that is important to be aware of when planning the installation.

Installing a Husqvarna robotic lawnmower involves four main components:

- A robotic lawnmower that mows the lawn by essentially operating in a random pattern. The robotic lawnmower is powered by a maintenance-free battery.
- A charging station, to where the robotic lawnmower automatically returns when the charge level in the battery becomes too low.

The charging station has three functions:

- To send control signals along the boundary wire.
 - To send control signals along the guide wire.
 - To charge the battery in the robotic lawnmower.
- A power supply, which is connected between the charging station and a 100V-240V wall socket. The power supply is connected to the wall socket and to the charging station using a 10 m long low voltage cable. The low voltage cable must not be shortened or extended.

A longer low voltage cable is available as optional accessory. Please contact your dealer for more information.

The appearance of the power supply may differ depending on market.

- A loop wire, laid in a loop around the robotic lawnmower's working area. The loop wire is laid around the edges of the lawn and around objects and plants that the robotic lawnmower must not run into. The loop wire is also used as the guide wire.

The maximum permitted length for the boundary loop is 800 m.

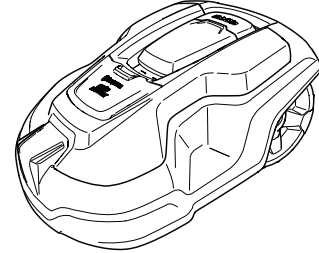

3012-1305

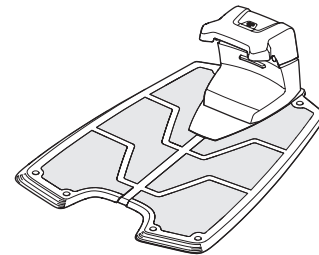

3012-1041

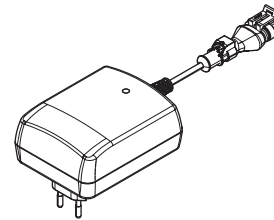

3012-1352

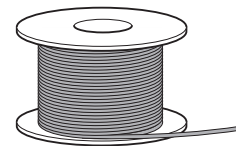

3012-221

IMPORTANT INFORMATION

Loop wire for the boundary, pegs, connector for the loop wire and couplers for the loop wire are purchased in a separate Installation kit.

Always use genuine spare parts and accessories

PRESENTATION

2.1 What is what?

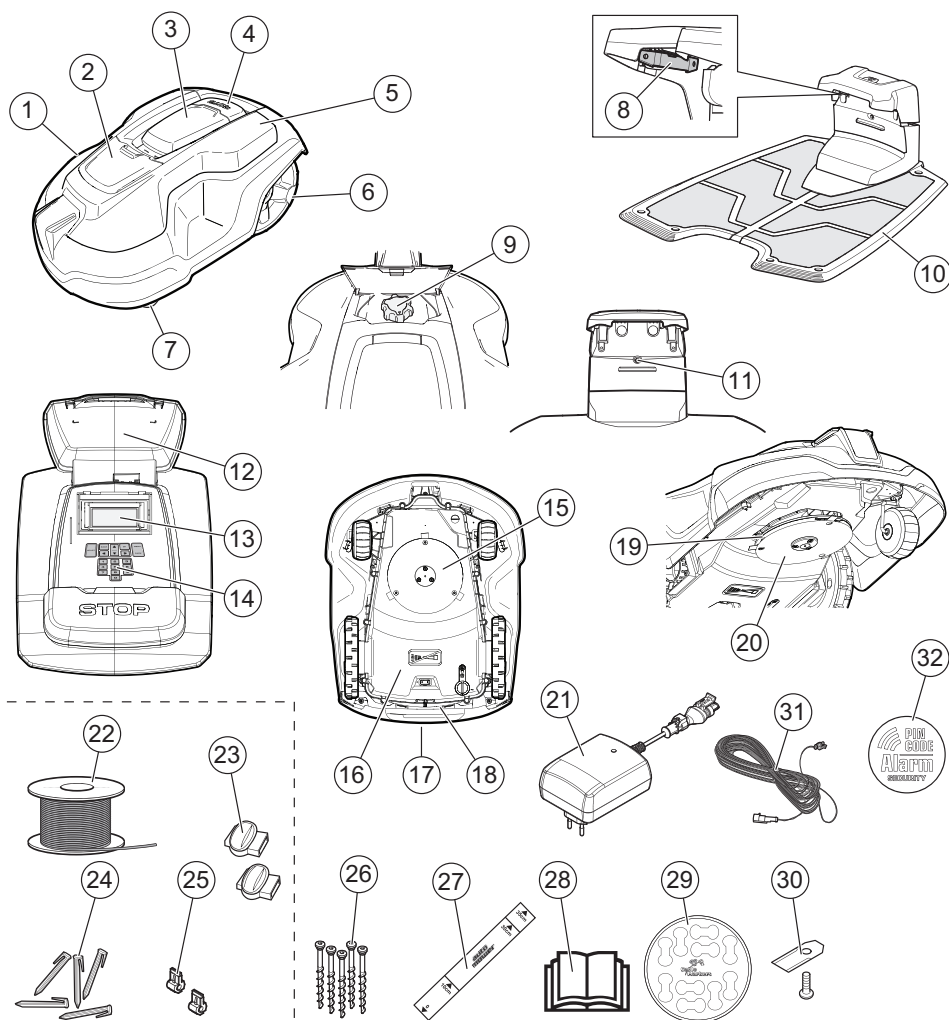

The numbers in the illustration represent:

- | | |
|---|--|
| <ol style="list-style-type: none"> 1. Body 2. Hatch to cutting height adjustment 3. Hatch to display and keypad 4. Stop button/Catch to open the hatch 5. Replaceable cover 6. Rear wheels 7. Front wheels 8. Contact strips 9. Cutting height adjustment 10. Charging station 11. LED for operation check of the charging station, boundary wire and guide wire 12. Rating plate 13. Display 14. Keypad 15. Cutting system 16. Chassis box with electronics, battery and motors 17. Handle 18. Main switch 19. Blade disc 20. Skid plate | <ol style="list-style-type: none"> 21. Power supply (the appearance of the power supply may differ depending on market) 22. Loop wire for boundary loop and guide wire* 23. Connector for loop wire* 24. Pegs* 25. Couplers for the loop wire* 26. Screws for securing the charging station 27. Measurement gauge for help when installing the boundary wire (the measurement gauge is broken loose from the box) 28. Operator's Manual and Quick Guide 29. Cable markers 30. Extra blades 31. Low voltage cable 32. Alarm decal |
|---|--|

*Included in Installation kit, not included in the purchase of the robotic lawnmower

3012-1306

PRESENTATION

2.2 Package content

Your Automower® package will include the following parts.

Robotic lawnmower	√
Charging station	√
Power supply	√
Charging station screws	5 pcs
Low voltage cable	√
Allen key	√
Measurement gauge	√
Operator's Manual and Quick Guide	√
Cable markers	√
Extra blades	9 pcs
Alarm decal	√

2.3 Function

Capacity

The robotic lawnmower is recommended for lawns up to 1,500 m² (1,000 m² for Automower® 310).

How big an area the robotic lawnmower can keep cut depends primarily on the condition of the blades and the type, growth and moisture of the grass. The shape of the garden is also significant. If the garden mainly consists of open lawn areas, the robotic lawnmower can mow more per hour than if the garden consists of several small lawns separated by trees, flower beds and passages.

A fully charged robotic lawnmower mows for 60 to 80 minutes, depending on the age of the battery and how thick the grass is. Then the robotic lawnmower will charge for 60 to 70 minutes. The charging time can vary depending on, among other factors, the ambient temperature.



PRESENTATION

Mowing technique

The cutting system in the Husqvarna robotic lawnmower is based on an efficient and energy saving principle. Unlike many standard lawnmowers, the robotic lawnmower cuts the grass instead of knocking it off.

We recommend you allow the robotic lawnmower to mainly mow in dry weather to obtain the best possible result. Husqvarna's robotic lawnmowers can also mow in the rain, however, wet grass easily sticks on the robotic lawnmower and there is a greater risk of slipping on steep slopes.

The blades must be in good condition to obtain the best mowing result. In order to keep the blades sharp for as long as possible it is important to keep the lawn free from branches, small stones and other objects which can damage the blades.

Replace the blades regularly for the best mowing result. It is very easy to replace the blades. See 8.7 *Blades on page 73*.

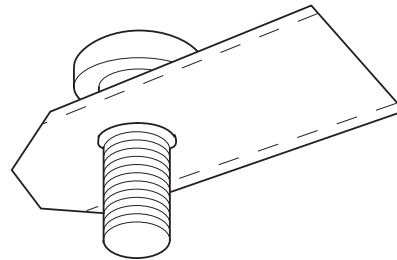

3020-002

Working method

The robotic lawnmower automatically mows the lawn. It continuously alternates between mowing and charging.

The robotic lawnmower starts to search for the charging station when the battery charge becomes too low. The robotic lawnmower does not mow when it is searching for the charging station.

When the robotic lawnmower is searching for the charging station, it can find it in a number of different ways. See *Finding the charging station on page 14*.

When the battery is fully charged, the robotic lawnmower will leave the charging station and start mowing in a predefined area in the garden. You might have to set manual exit settings to make sure that the lawn will be cut evenly, see 6.7 *"Installation" on page 50*.

When the robotic lawnmower body hits an obstacle, the robotic lawnmower reverses and selects a new direction.

Sensors at the front and back will sense when the robotic lawnmower is approaching the boundary wire. The robotic lawnmower travels up to 32 centimetres beyond the wire before it turns around.

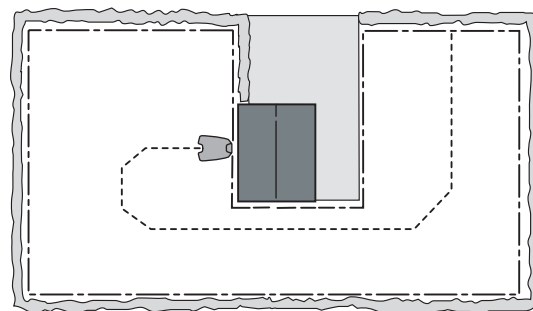

3023-003

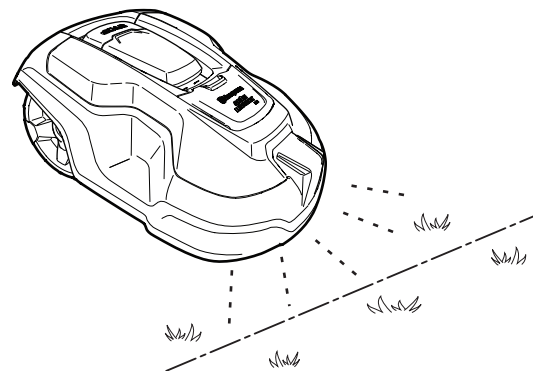

3012-1308



PRESENTATION

The **STOP** button on the top of the robotic lawnmower is mainly used to stop the robotic lawnmower when it's running. When the **STOP** button is pressed a hatch opens, behind which there is a control panel. The **STOP** button remains pressed in until the hatch is closed again. This together with the **START** button acts as a start inhibitor.

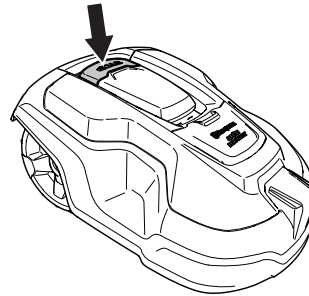

3012-1381

The control panel on the top of the robotic lawnmower is where you manage all the robotic lawnmower settings.

When the main switch is set to 1 for the first time, a start-up sequence begins which includes a number of important basic settings. See 3.8 *First start-up and calibration* on page 33.

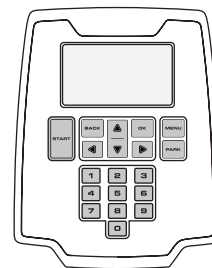

3012-1094

Movement pattern

The movement pattern of the robotic lawnmower is random and is determined by the robotic lawnmower itself and depends on how the lawn looks. The mower will not always drive in straight lines and a movement pattern is never repeated. With this cutting system the lawn is mown very evenly without any straight mowing lines from the robotic lawnmower.

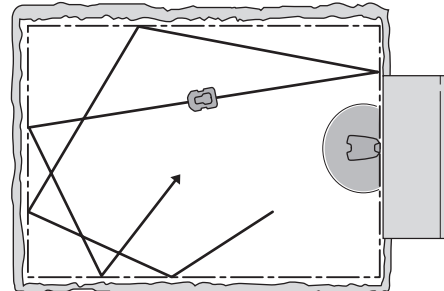

3023-034

Finding the charging station

The robotic lawnmower can be set to search for the charging station in one or more of three different ways. The robotic lawnmower automatically combines these three search methods to locate the charging station as fast as possible but also to avoid as much tracks forming as possible.

Using the manual settings options the three search methods can be combined to optimise the search for the charging station for the shape of the garden in question, see 6.7 *Installation* on page 50.

Search method 1: Irregular

The robotic lawnmower operates irregularly until it gets close to the charging station.

The benefit with this search method is that there is no risk of tracks on the lawn from the robotic lawnmower. The disadvantage is that search times can be somewhat long.

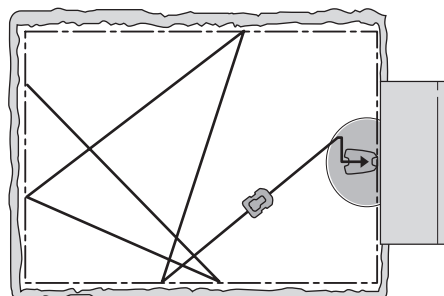

3023-035



PRESENTATION

Search method 2: Follow guide wire

The robotic lawnmower operates irregularly until it reaches the guide wire. Then the robotic lawnmower follows the guide wire to the charging station.

The guide wire is a wire that is laid from the charging station towards, for instance, a remote part of the working area or through a narrow passage to be then connected with the boundary loop. See 3.6 *Installation of the guide wire* on page 29.

This search method makes it easier for the robotic lawnmower to find the charging station beyond many or large islands, narrow passages or steep slopes.

The benefit of this search method is shorter search times.

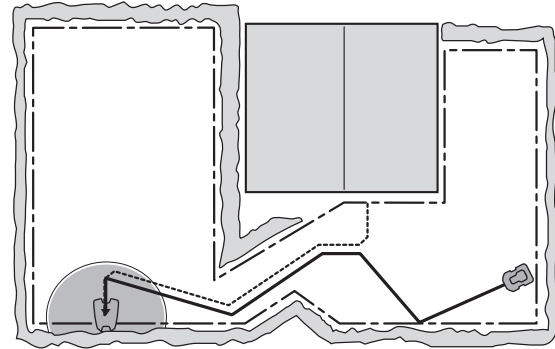

3023-036

Search method 3: Follow boundary wire

The robotic lawnmower operates irregularly until it reaches the boundary loop. Then it follows the boundary loop to the charging station. The robotic lawnmower randomly selects to travel clockwise or anticlockwise.

This search method is suitable in an installation with an open lawn space, wide passages (wider than about 3 metres) and no or only a few small islands.

The benefit of this search method is that there is no need to install a guide wire.

The disadvantage is that some tracks can be formed in the lawn alongside the boundary loop. The search time will also be longer if there are narrow passages or numerous islands in the installation.

As a rule, this search method is used only if the robotic lawnmower cannot find the charging station using search method 1 or 2 within the expected time period.

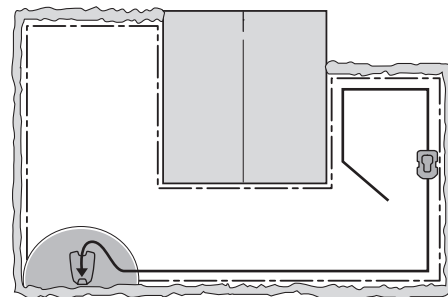

3023-037

3 Installation

This chapter describes how to install the robotic lawnmower. Before starting the installation read the previous chapter 2. *Presentation*.

Read also through this entire chapter before beginning the installation. How the installation is done also affects how well the robotic lawnmower works. It is therefore important to plan the installation carefully.

Planning is simplified if you make a sketch of the working area, including all obstacles. This makes it easier to see the ideal positions for the charging station, the boundary wire and the guide wire. Draw on the sketch where the boundary and guide wires should be routed.

See 7 *Garden examples on page 64* for installation examples.

Visit also www.automower.com for further descriptions and tips regarding installation.

Carry out the installation as outlined in the following steps:

- 3.1 Preparations
- 3.2 Installation of the charging station
- 3.3 Charging the battery
- 3.4 Installation of the boundary wire
- 3.5 Connecting the boundary wire
- 3.6 Installation of the guide wire
- 3.7 Checking the installation
- 3.8 First start-up and calibration
- 3.9 Test docking with the charging station

The charging station, boundary loop and guide wire must be connected to be able to carry out a complete start-up.

3.1 Preparations

1. If the lawn in the working area is longer than 10 cm mow it using a standard lawnmower. Then collect the grass.
2. Fill in holes and hollows to stop rainwater forming pools of water. The product may be damaged if it is operated in pools of water. See 11 *Guarantee terms on page 85*.
3. Read carefully through all the steps before the installation.

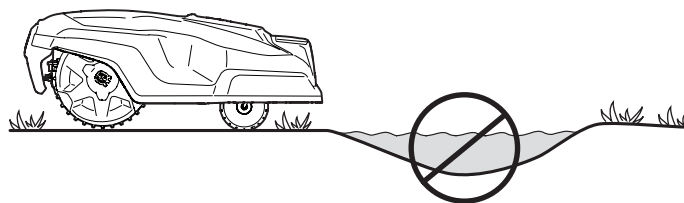

3012-1310

INSTALLATION

4. Check that all parts for the installation are included. The numbers in brackets refer to the component illustration. See 2.1 *What is what?* on page 11.

- Robotic lawnmower
- Charging station (10)
- Loop wire for boundary loop and guide wire (22)
- Power supply (21)
- Low voltage cable (31)
- Pegs (24)
- Connectors for the loop wire (23)
- Screws for the charging station (26)
- Measurement gauge (27)
- Couplers for the loop wire (25)
- Cable markers (29)

During installation you will also need:

- Hammer/plastic mallet (to simplify putting the pegs in the ground).
- Combination pliers for cutting the boundary wire and pressing the connectors together.
- Polygrip (for pressing the couplers together).
- Edge cutter/straight spade if the boundary wire must be buried.

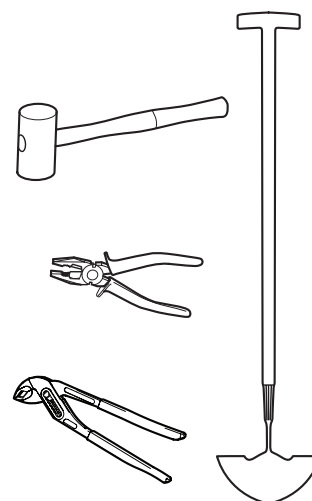

3.2 Installation of the charging station

Best charging station location

Take the following aspects into consideration when identifying the best location for the charging station:

- Allow for at least 3 metres of free space in front of the charging station.
- It must be close to a wall socket. The supplied low voltage cable is 10 metres long.
- A level surface free from sharp objects to place the charging station on.
- Protection from water spray for instance from irrigation.
- Protection from direct sunlight.
- Possible requirement to keep the charging station out of sight for outsiders.

3012-1311



INSTALLATION

The charging station must be positioned with a great deal of free space in front of it (at least 3 metres). It should also be centrally placed in the working area to make it easier for the robotic lawnmower to reach all areas in the working area.

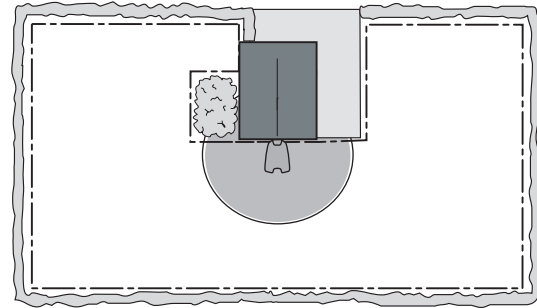

3023-038

Do not put the charging station in confined spaces in the working area. This can make it difficult for the robotic mower to find the charging station.

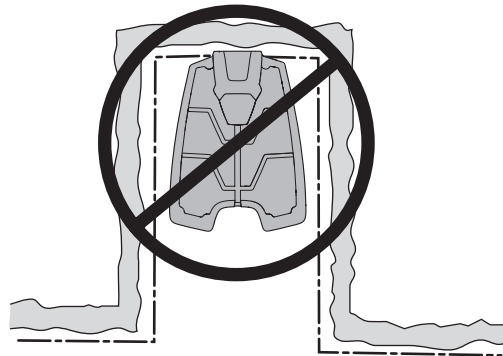

3012-555

The charging station must be positioned on relatively level ground. The front end of the charging station must be a maximum of 5 cm higher or lower than the back end.



3012-1312

The charging station must not be positioned in a way that can bend its base plate.



3012-1053



INSTALLATION

Connecting the power supply

Take the following into consideration when planning where to place the power supply:

- Close to the charging station
- Protection from rain
- Protection from direct sunlight

If the power supply is connected to an electrical socket outdoors, this must be approved for outdoor use.

The low voltage cable for the power supply is 10 metres long, and may not be shortened or extended. A longer low voltage cable is available as optional accessory. Please contact your dealer for more information.

It is not allowed to connect the power supply directly to the charging station. The low voltage cable must always be used.

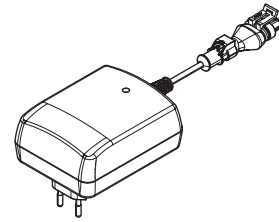

3012-1352

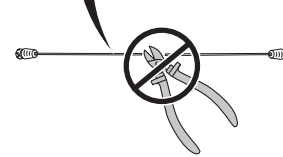

3018-069

IMPORTANT INFORMATION

The low voltage cable must not under any circumstances be shortened or extended.

It is possible to let the low voltage cable cross the working area. The low voltage cable must be stapled down or buried.

Make sure the low voltage cable is laid along the ground and secured with pegs. The cable must lie close to the ground so as not to be cut before the grass roots have grown over it.

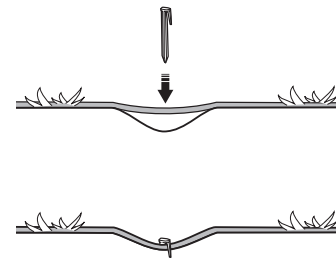

3018-085

IMPORTANT INFORMATION

Place the low voltage cable so that the blades on the blade disc can never come in contact with it.

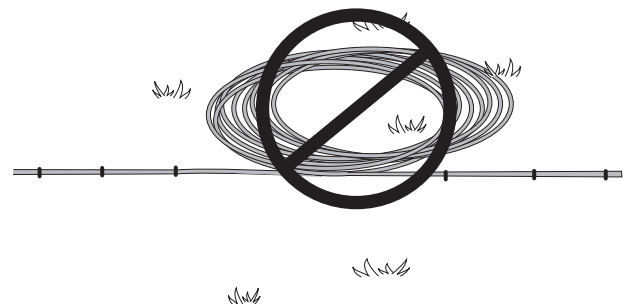

3012-281

The power supply must be placed where it is well ventilated and is not exposed to direct sunlight. The power supply must be placed under a roof.

It is recommended to use a ground fault circuit interrupter when connecting the power supply to the wall socket.

The power supply must be mounted on a vertical surface, such as a wall or a fence.-

INSTALLATION

Do not, under any circumstances, mount the power supply at a height where there is a risk it can be submerged in water (at least 30 cm from the ground). It is not permitted to place the power supply on the ground.

Never connect the power supply to a outlet if plug or cord is damaged. Damaged or entangled cord increase the risk of electric shock.

IMPORTANT INFORMATION

Use the power supply's plug to disconnect the charging station, for instance before cleaning or repairing the loop wire.

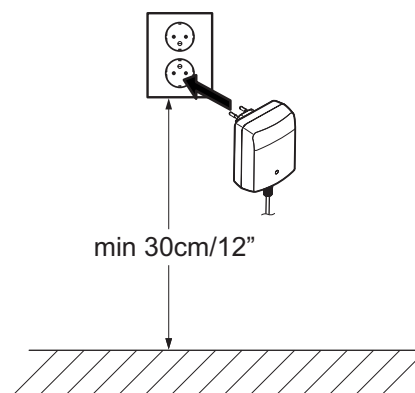

3012-1344

Installing and connecting the charging station

1. Position the charging station in a suitable spot.
2. Tilt the protective cover on the charging station forward and connect the low voltage cable to the charging station.
3. Connect the power supply's power cable to a 100-240 V wall socket.
4. Attach the charging station to the ground using the supplied screws. Ensure the screws are screwed all the way down in the countersink. If the charging station is placed against a wall, it is best to wait before securing the charging station to the ground until after all the wires have been connected.

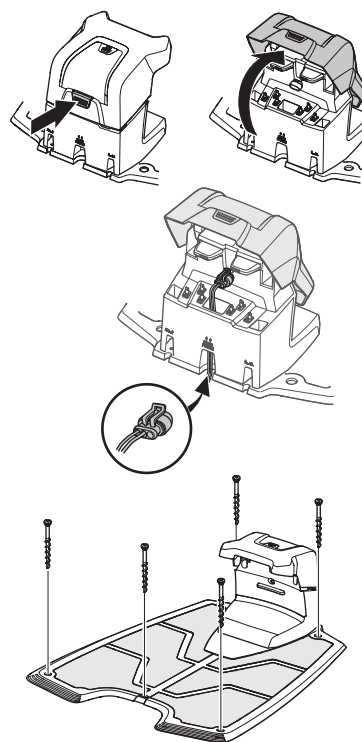

3012-1110

IMPORTANT INFORMATION

It is not permitted to make new holes in the charging station's plate. Only the existing holes may be used to secure the base plate to the ground.

3012-1345

IMPORTANT INFORMATION

Do not tread or walk on the charging station's plate.



3012-1045



INSTALLATION

3.3 Charging the battery

As soon as the charging station is connected, it is possible to charge the robotic lawnmower. Set the main switch to position 1.

Place the robotic lawnmower in the charging station to charge the battery while the boundary and guide wires are being laid.

If the battery is flat, it takes around 80 to 100 minutes to fully charge it.

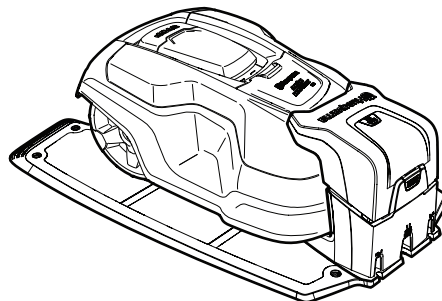

3012-1313

IMPORTANT INFORMATION

The robotic lawnmower cannot be used before the installation is complete.

INSTALLATION

3.4 Installation of the boundary wire

Ensure correct installation of the boundary wire according to the instruction

The boundary wire can be installed in one of the following ways:

- Secure the wire to the ground with pegs.

It is preferable to staple down the boundary wire if you want to make adjustments to the boundary loop during the first few weeks of operation. After a few weeks the grass will have grown over the wire making it no longer visible. Use a hammer/plastic mallet and the pegs supplied when carrying out the installation.

- Bury the wire.

It is preferable to bury the boundary wire if you want to dethatch or aerate the lawn. If necessary, both methods can be combined so one part of the boundary wire is pegged down and the remainder is buried. The wire can be buried for instance using an edge cutter or a straight spade. Make sure to lay the boundary wire at least 1 cm and a maximum of 20 cm in the ground.

Plan where to lay the boundary wire

The boundary wire must be laid so that:

- The wire forms a loop around the working area for the robotic lawnmower. Only original boundary wire must be used. It is specially designed to resist dampness from the soil that could otherwise easily damage the wires.
- The robotic lawnmower is never more than 35 metres from the wire at any point in the entire working area.
- The wire is no more than 800 metres long.
- About 20 cm of extra wire is available to which the guide wire will be connected later. See 3.6 *Installation of the guide wire* on page 29 .

Depending on what the working area is adjacent to, the boundary wire must be laid at different distances from obstacles. The illustration below shows how the boundary wire must be laid around the working area and around obstacles. Use the supplied measurement gauge to obtain the correct distance. See 2.1 *What is what?* on page 11.

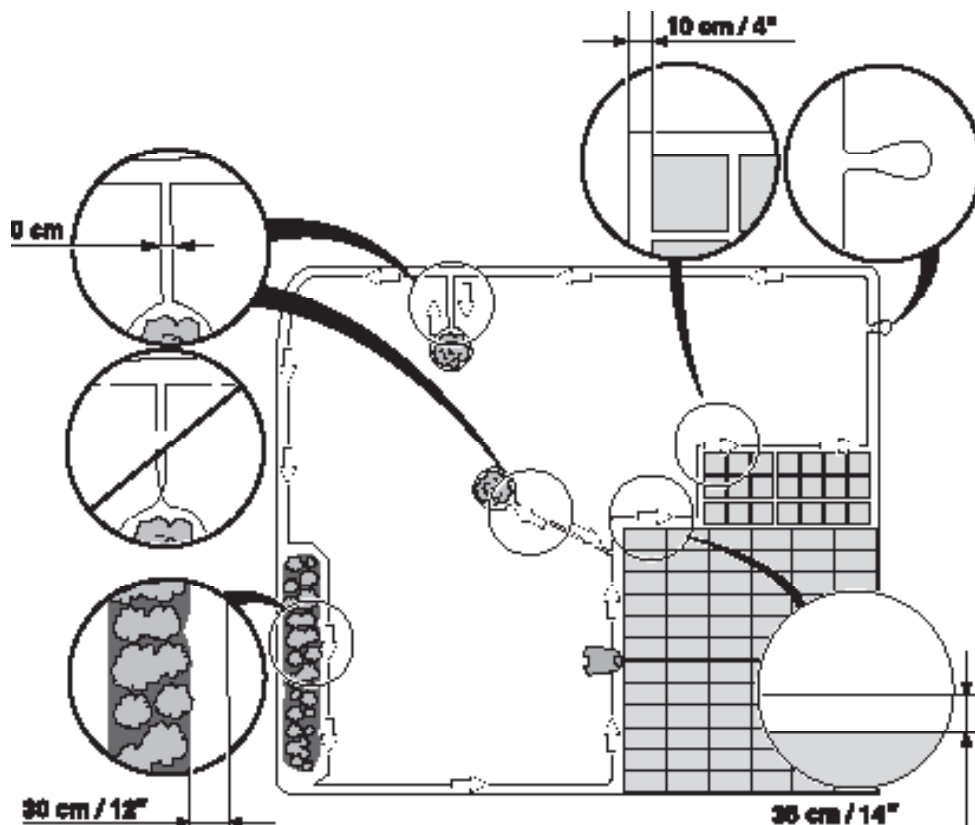

3023-031



INSTALLATION

Working area boundaries

If a high obstacle (5 cm or more), for example a wall or fence, borders the working area, the boundary wire should be laid 35 cm from the obstacle. This will prevent the robotic lawnmower from colliding with the obstacle and reduce body wear.

About 20 cm of the lawn around the fixed obstacle will not be mown.

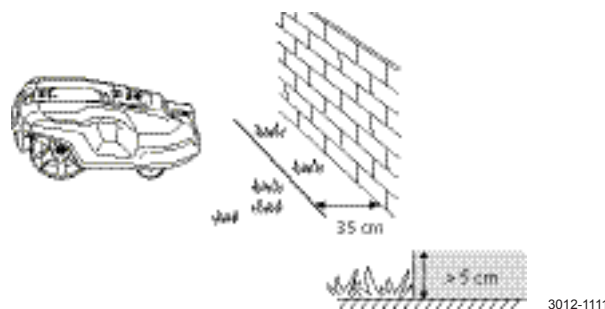

3012-1111

If the working area borders on a small ditch, for example a flower bed or a small elevation, for example a low kerbstone (1-5 cm), the boundary wire should be laid 30 cm inside the working area. This prevents the wheels from driving into the ditch or up onto the kerbstone which might lead to excessive wear on the robotic lawnmower, and especially the front wheels.

About 15 cm of the lawn along the ditch/kerbstone will not be mown.

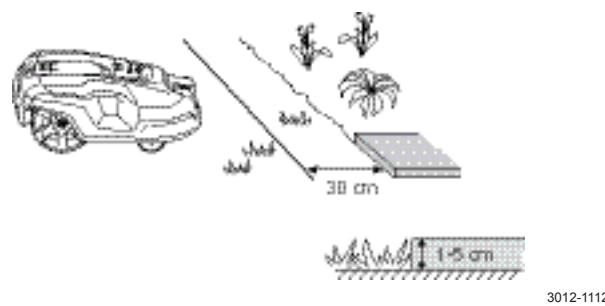

3012-1112

If the working area borders on a paving stone path or similar that is level with the lawn (+/- 1 cm), it is possible to allow the robotic lawnmower to run a little over the path. The boundary wire should then be laid 10 cm from the edge of the path.

All the grass along the side of the paving stone path will be cut.

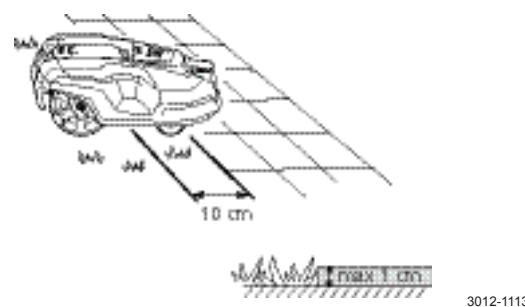

3012-1113

When the working area is divided by a paving stone path that is level with the lawn, it is possible to allow the robotic lawnmower to run over the path. It can be an advantage to lay the boundary wire under the paving stones. The boundary wire can also be laid in the joint between the paving stones. Ensure that the tiles are in level with the lawn to avoid excessive wear on the robotic lawnmower.

Note: The robotic lawnmower must never run over gravel, mulch or similar material which can damage the blades.

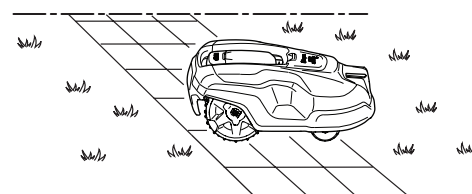

3012-1114

IMPORTANT INFORMATION

If the working area is adjacent to water bodies, slopes, precipices or a public road, the boundary wire must be supplemented with an edging or the like. It must then be at least 15 cm in height. This will prevent the robotic lawnmower from ending up outside the working area under any circumstance.

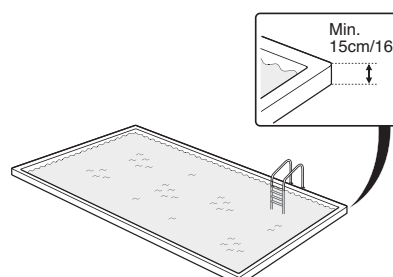

3018-046



INSTALLATION

Boundaries within the working area

Use the boundary wire to isolate areas inside the working area by creating islands around obstacles which cannot withstand a collision, for example flowerbeds, bushes and fountains. Lay the wire up to and around the area to be isolated, and then return it back along the same route. If pegs are used, the wire should be laid under the same pegs on the return route. When the boundary wires to and from the island are laid close together, the robotic lawnmower can drive over the wire.

IMPORTANT INFORMATION

The boundary wire may not be crossed on its way to and from an island.

Obstacles that can withstand a collision, for example, trees or bushes taller than 15 cm, do not need to be isolated with the boundary wire. The robotic lawnmower will turn around when it collides with this type of obstacle.

It is recommended to isolate all fixed objects in and around the working area. This results in the most gentle and silent operation and prevent the robotic lawnmower from getting stuck in the objects under any circumstances.

Obstacles that slope slightly, for example stones or large trees with raised roots, must be isolated or removed. Otherwise the robotic lawnmower can slide up onto this kind of obstacle causing the blades to be damaged.

Secondary areas

If the working area consists of two areas which the robotic lawnmower has difficulty travelling between, it is recommended to set up a secondary area. Instances of this are 40% slopes or a passage that is narrower than 60 cm. Lay the boundary wire then around the secondary area so that it forms an island outside of the main area.

The robotic lawnmower must be moved manually between the main and secondary area when the lawn in the secondary area has to be cut. The *Secondary area (A)* operating mode must be used as the robotic lawnmower cannot travel on its own from the secondary area to the charging station. See 5.1 *Operation selection Start on page 40*. In this mode, the robotic lawnmower will never look for the charging station but will mow until the battery runs out. When the battery is flat, the robotic lawnmower will stop and the *Needs manual charging* message will appear in the display. Then place the robotic lawnmower in the charging station to charge the battery. If the main area has to be cut straight after charging, the **START** button must be pressed and the *Main area (B)* selected before closing the hatch.

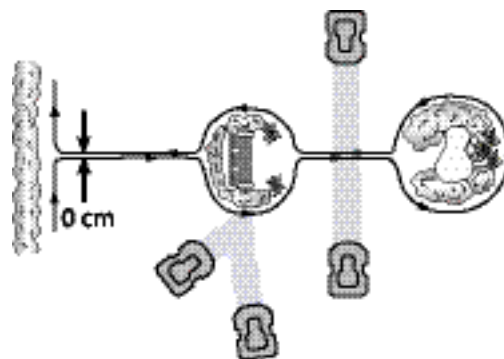

3023-005

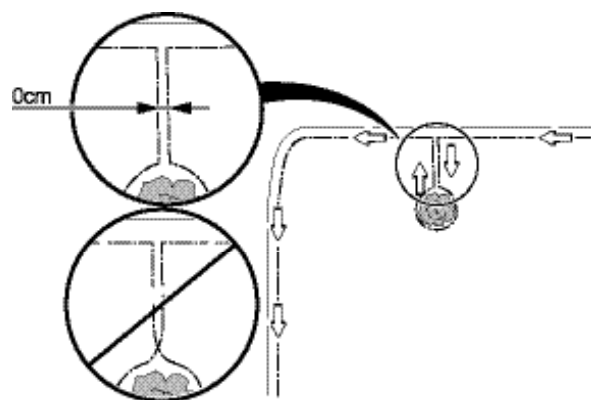

3012-686

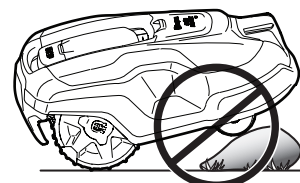

3012-1319

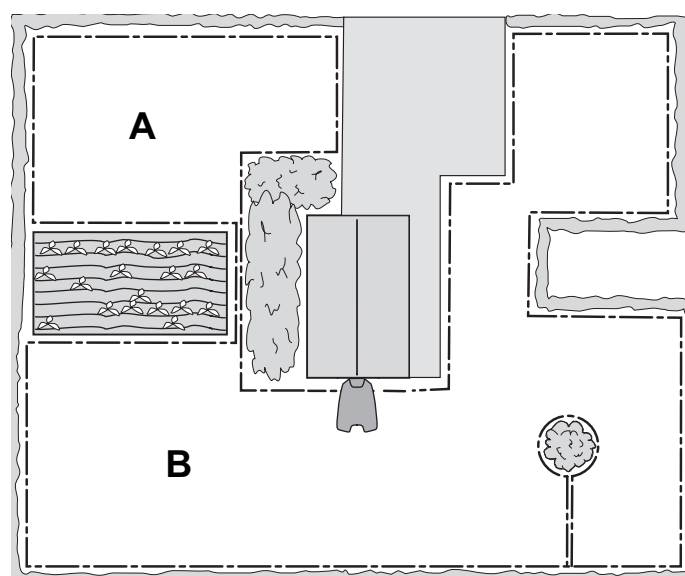

3023-006

INSTALLATION

Passages when mowing

Long and narrow passages and areas narrower than 1.5 to 2 metres should be avoided. When the robotic lawnmower mows, there is a risk that it travels around in the passage or area for a long period of time. The lawn will then look flattened.

Slopes

The robotic lawnmower can also operate on sloping working areas. The maximum gradient is defined as percentage units (%). The slope as a percentage is calculated as the difference in elevation in centimetres for every metre. If for instance the difference in elevation is 10 cm, the slope gradient is 10%. See the illustration.

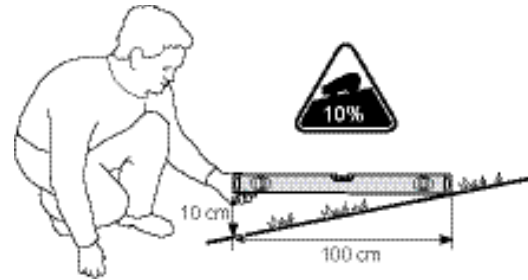

3012-1346

The boundary wire can be laid across a slope that slants less than 15%.

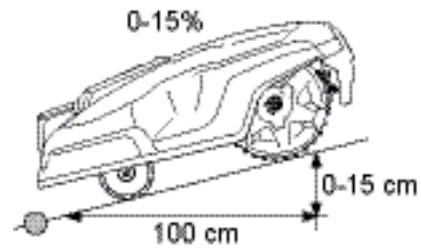

3012-1321

The boundary wire should not be laid across a slope that is steeper than 15%. There is a risk that the robotic lawnmower will find it difficult to turn there. The robotic lawnmower will then stop and the *Outside working area* fault message is displayed. The risk is at its greatest in damp weather conditions, as the wheels can slip on the wet grass.

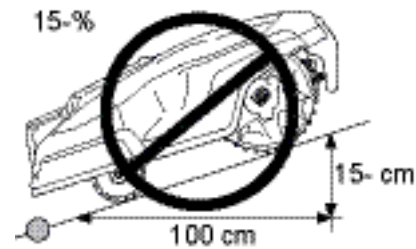

3012-1322

However, the boundary wire can be laid across a slope steeper than 15% if there is an obstacle that the robotic lawnmower is allowed to collide with, for example, a fence or a dense hedge.

Inside the working area the robotic lawnmower can mow areas which slope up to 40%. Areas that slope more must be isolated with the boundary wire.

When a part of the working area's outer edge slopes more than 15%, the boundary wire must be laid about 20 cm in on the flat ground before the beginning of the slope.

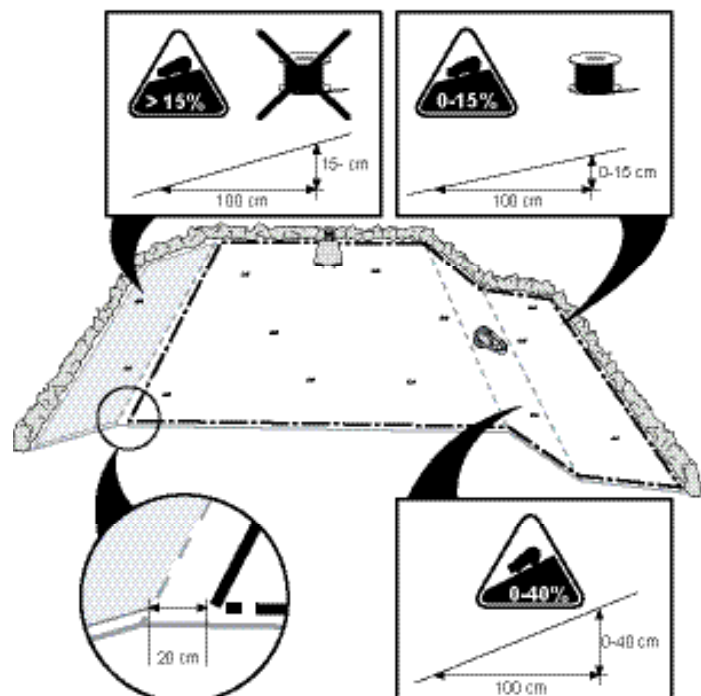

3012-1387

English - 25

INSTALLATION

Laying the boundary wire

If you intend to peg down the boundary wire:

- Cut the grass very low with a standard lawnmower or a trimmer where the wire is to be laid. It will then be easier to lay the wire close to the ground and the risk of the robotic lawnmower cutting the wire or damaging the insulation of the wire is reduced.
- Make sure to lay the boundary wire close to the ground and secure the pegs close together. The cable must lie close to the ground so as not to be cut before the grass roots have grown over it.
- Use a hammer to knock the pegs into the ground. Exercise care when knocking in the pegs and make sure the wire is not under strain. Avoid sharp bends in the wire.

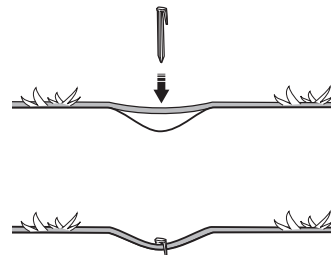

3018-085

If the boundary wire is to be buried:

- Make sure to lay the boundary wire at least 1 cm and a maximum of 20 cm in the ground. The wire can be buried for instance using an edge cutter or a straight spade.

Use the supplied measurement gauge as a guide when you lay out the boundary wire. This helps you to easily set the correct distance between the boundary wire and the boundary/obstacle. The measurement gauge is broken loose from the box.

IMPORTANT INFORMATION

Extra wire must not be placed in coils outside the boundary wire. This can disrupt the robotic lawnmower.

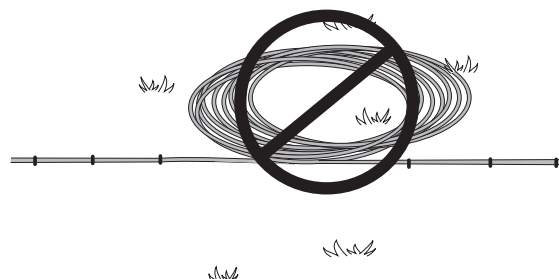

3012-281

Eyelet for connecting the guide wire

To facilitate the connection of the guide wire to the boundary wire, it is recommended to create an eyelet with about 20 cm of extra boundary wire at the point where the guide wire will later be connected. It is a good idea to plan where the guide wire will be placed before laying out the boundary wire. See 3.6 *Installation of the guide wire* on page 29.

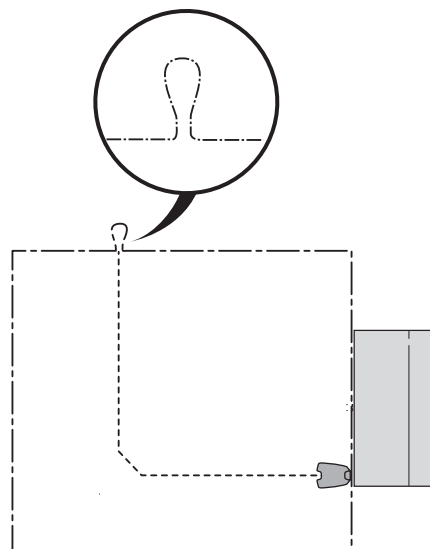

3023-007



INSTALLATION

Laying the boundary wire in towards the charging station

On its way toward the charging station, the boundary wire can be laid completely outside the charging station (see option 1 in the figure). If there is a need to partly locate the charging station outside the working area, it is also possible to lay the wire under the charging station plate (see option 2 in the figure).

However most of the charging station must not be placed outside the working area as the robotic lawnmower can then find it difficult to find the charging station (see figure).

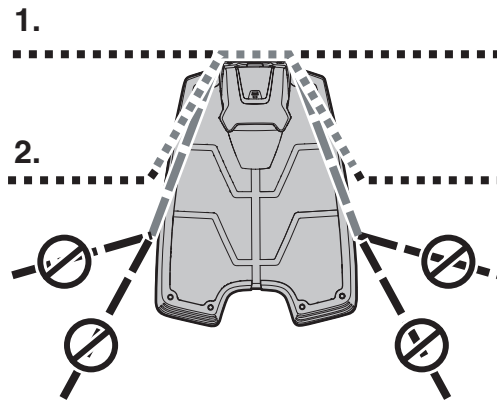

3012-1065

Splicing the boundary wire

Use an original coupler if the boundary wire is not long enough and needs to be spliced. It is waterproof and gives a reliable electrical connection.

Insert both wire ends in the coupler. Check that the wires are fully inserted into the coupler so that the ends are visible through the transparent area on the other side of the coupler. Now press down the button on top of the coupler fully. Use a polygrip to completely press down the button on the coupler.

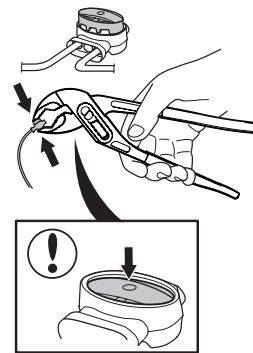

3012-1323

IMPORTANT INFORMATION

Twinned cables, or a screw terminal block that is insulated with insulation tape are not satisfactory splices. Soil moisture will cause the wire to oxidise and after a time result in a broken circuit.





INSTALLATION

3.5 Connecting the boundary wire

Connect the boundary wire to the charging station:

IMPORTANT INFORMATION

The boundary wire must not be crossed when connecting it to the charging station. The right hand wire end must be connected to the right hand pin on the charging station and the left hand wire end to the left pin.

1. Place the wire ends in the connector:

- Open the connector.
- Place the wire in the connector grip.

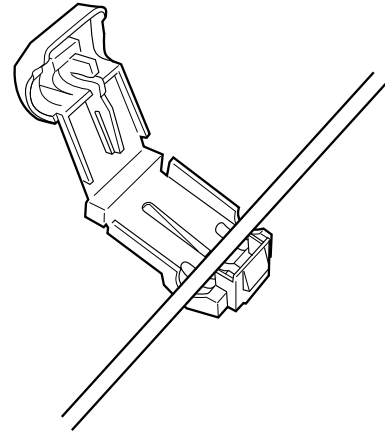

3012-284

2. Press the connectors together using a pair of pliers. Press until you hear a click.

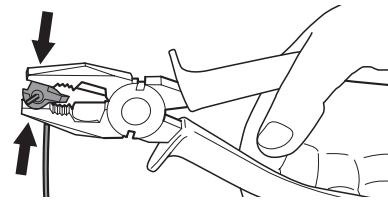

3012-264

3. Cut off any surplus boundary wire. Cut 1-2 cm above each connector.

4. Tilt the protective cover on the charging station forward and run the wire ends up each channel at the rear of the charging station. Press the connector onto the metal pins, marked AL (left) and AR (right), on the charging station.

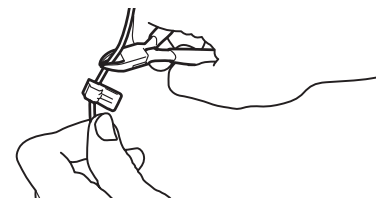

3012-265

5. Mark the wires with the accompanying cable markers. This makes it easier to reconnect the wires correctly when for instance the charging station has been stored indoors for the winter.

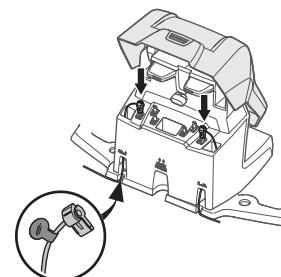

3012-1091

IMPORTANT INFORMATION

The right hand connector must be connected to the right hand metal pin on the charging station and the left hand wire end to the left connector.





INSTALLATION

3.6 Installation of the guide wire

The guide wire is a wire that is laid from the charging station towards, for instance, a remote part of the working area or through a narrow passage to be then connected with the boundary loop. The same cable roll is used for both the boundary loop and guide wire.

The guide wire is used by the robotic lawnmower to find its way back to the charging station but also to guide the robotic lawnmower to hard-to reach areas of the garden.

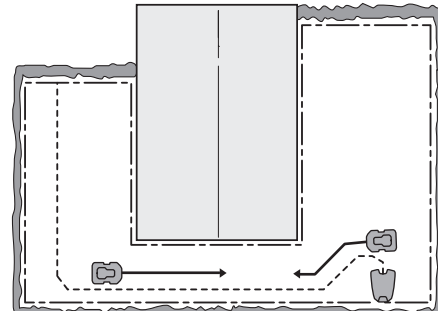

3023-008

Run the robotic lawnmower at varying distances from the guide wire to reduce the risk of tracks forming. The area beside the wire which the robotic lawnmower then uses is called the Corridor. The wider the corridor allowed by the installation, the less the risk of tracks forming. When installing, it is therefore important to create as much free space as possible along the guide wire.

The robotic lawnmower always runs to the left of the guide wire as seen facing the charging station. Thus the corridor is to the left of the guide wire. When installing, it is therefore important to create as much free space as possible to the left of the guide wire, as seen facing the charging station. It is not allowed to lay the guide wire closer than 30 cm from the boundary wire.

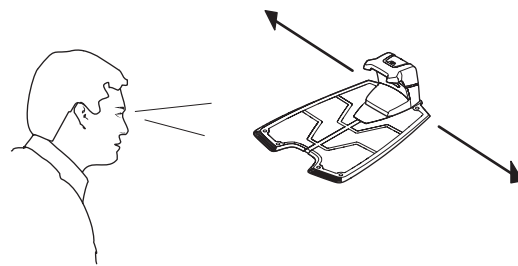

3012-1100

IMPORTANT INFORMATION

Make sure to have as much free space as possible to the left of the guide wire, as seen facing the charging station.



INSTALLATION

Laying and connecting the guide wire

1. Before laying and connecting the guide wire, it is important to give consideration to the length of the guide loop, especially in large or complex installations. If the guide loop is longer than 400 metres the robotic lawnmower can have difficulty following the guide wire.

The guide wire together with the section of the boundary loop that makes up the return wire to the charging station is called the guide loop. The current in the guide loop always goes to the left at the connection from the guide wire to the boundary loop. The two figures here display what is regarded as a guide loop. The figures are also a good example of how the guide loop in a working area can have very varying lengths depending on where the charging station is placed.

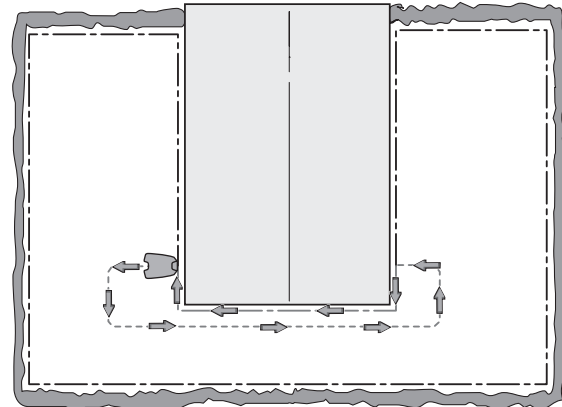

3023-009

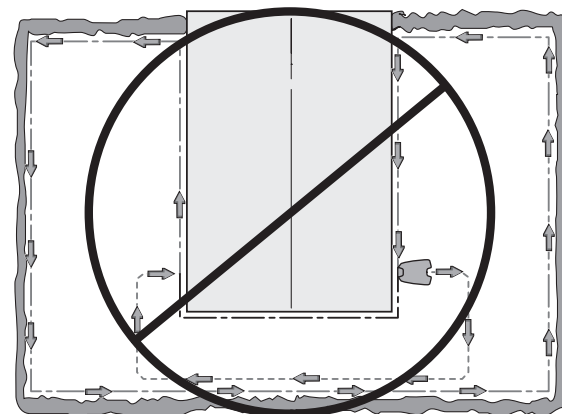

3023-010

2. Tilt the top cover on the charging station forward and run the guide wire up the channel leading to the guide connection.
3. Fit a connector to the guide wire in the same way as for the boundary wire in 3.5 *Connecting the boundary wire on page 27*. Connect it to the contact pin on the charging station that is labelled G1.
4. Mark the wires with the accompanying cable markers. This makes it easier to reconnect the wires correctly when for instance the charging station has been stored indoors for the winter.
5. Run the guide wire straight under the charging plate and then at least 2 metres straight out from the front edge of the plate.

Consider when laying the guide wire that as much space as possible is provided to the left (as seen facing the charging station) of the guide wire. The distance between the boundary loop and the guide wire must however be always at least 30 cm.

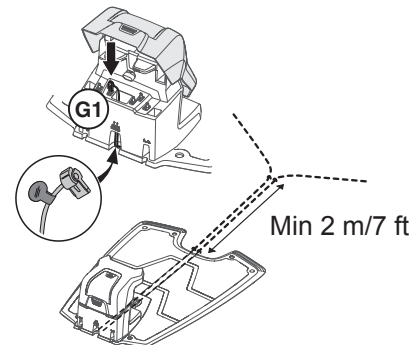

3012-1326

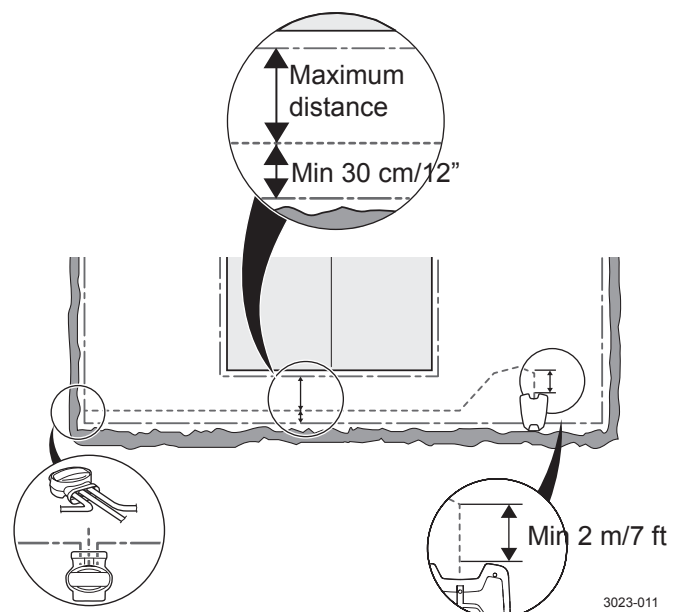

3023-011



INSTALLATION

If the guide wire has to be installed on a steep slope, it is an advantage to lay the wire at an angle to the slope. This makes it easier for the robotic lawnmower to follow the guide wire on the slope.

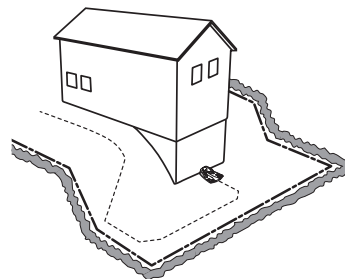

3018-061

Avoid laying the wire at sharp angles. This can make it difficult for the robotic lawnmower to follow the guide wire.

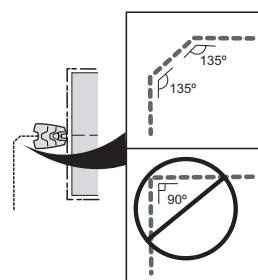

3012-1327

- Run the guide wire to the point on the boundary loop where the guide wire is to be connected.

Lift up the boundary wire. Cut the boundary wire using for instance a pair of wire cutters. Connecting the guide wire is made easier if an eyelet has been made on the boundary wire as outlined in the previous description. See *Eyelet for connecting the guide wire* on page 26.

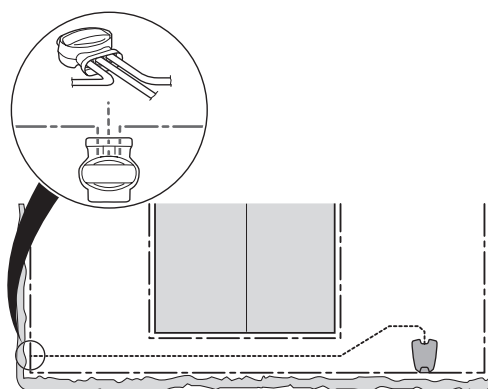

3023-015

- Connect the guide wire to the boundary wire using a coupler:

Insert the boundary wire and guide wire in the coupler. Check that the wires are fully inserted into the coupler so that the ends are visible through the transparent area on the other side of the coupler.

Use a polygrip to completely compress the button on the coupler.

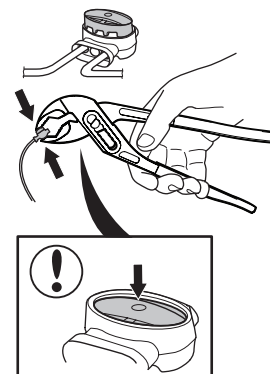

3018-1323

It does not matter which holes are used to connect each wire.

- Staple down/bury the splice in the lawn.

IMPORTANT INFORMATION

The guide wire may not cross the boundary wire, for instance a boundary wire that is laid out to an island.

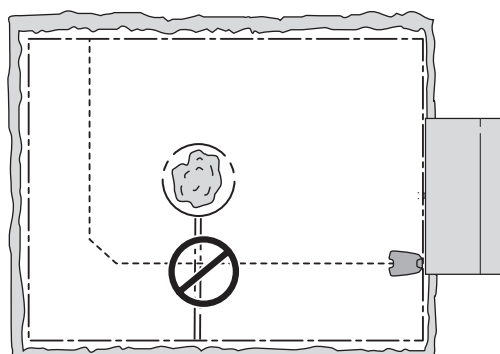

3023-016





INSTALLATION

3.7 Checking the installation

Check the loop signal by inspecting the indicator lamp on the charging station.

- Solid green light = good signals.
- Flashing green light = the loop system is turned off and the robotic lawnmower is in ECO mode. See 6.8 *Settings on page 59*.
- Flashing blue light = interruption in the boundary loop, no signal.
- Flashing red light = interruption in the charging station's antenna plate. The fault should be rectified by an authorized dealer.
- Solid blue light = weak signal. This may depend on the boundary loop being too long or that the wire is damaged. If the robotic lawnmower still works, this is not a problem.
- Solid red light = fault in the circuit board in the charging station. The fault should be rectified by an authorized dealer.

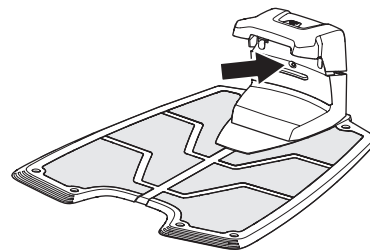

3012-1066

See 9.3 *Indicator lamp in the charging station on page 78* if the lamp does not indicate a solid or flashing green light.

INSTALLATION

3.8 First start-up and calibration

Before the robotic lawnmower is operated, a start-up sequence in the robotic lawnmower's menu must be carried out as well as an automatic calibration of the guide signal.

1. Open the control panel hatch by pressing the **STOP** button.
2. Set the main switch to position 1.

A start-up sequence begins when the robotic lawnmower is started for the first time. The following is requested:

- PIN code from factory. The code is provided on a special document received by the retailer at purchase.
- Language.
- Country.
- Date.
- Time.
- Selection and confirmation of personal PIN code. All combinations except 0000 are permitted.

Place the robotic lawnmower in the charging station and press **START**.

The robotic lawnmower will now begin to calibrate the guide wire. Press **START** and close the hatch. The calibration is performed by the robotic lawnmower backing out of the charging station and running a calibration process in front of the charging station. When this is completed, mowing can begin.

IMPORTANT INFORMATION

Use Memo on page 2 to make a note of the PIN code.

3.9 Test docking with the charging station

Before using the robotic lawnmower, check that the robotic lawnmower can follow the guide wire all the way to the charging station and easily docks with the charging station.

The test function is found in the robotic lawnmower's *Installation > Find charging station > Guide > More > Test guide* menu. For more information, See *Test settings on page 55*.

If no guide wire is installed the test must be carried out on the boundary wire, both clockwise and anti-clockwise.

The guide system must first be calibrated if the above test is to provide a satisfactory result. See *3.8 First start-up and calibration on page 33*.

MORE

Test Guide
Reset

3012-1428

4 Use

4.1 Charging a flat battery

When the Husqvarna robotic lawnmower is new or has been stored for a long period, the battery will be flat and needs to be charged before starting.

1. Set the main switch to position 1.
2. Place the robotic lawnmower in the charging station. Open the cover and slide the robotic lawnmower in as far as possible to ensure proper contact between the robotic lawnmower and the charging station.
3. The display shows a message that charging is in progress.

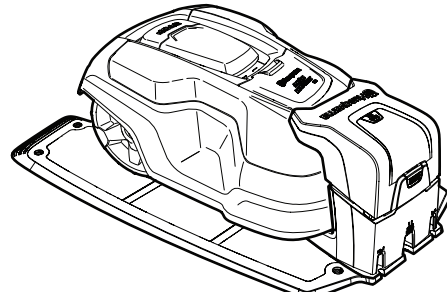

3012-1313

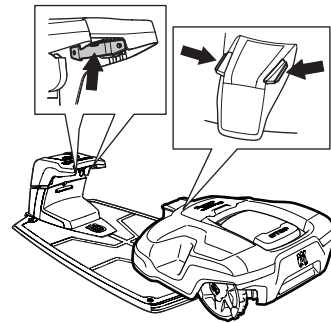

3012-1329



WARNING

Read the safety regulations before you start your robotic lawnmower.

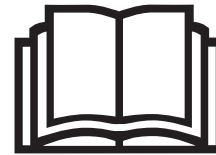

1001-003



WARNING

Keep your hands and feet away from the rotating blades. Never put your hands or feet close to or under the body when the motor is running.



3012-663



WARNING

Never use the robotic lawnmower when persons, especially children, or pets, are in the cutting area.

USE

4.2 Using the timer

The lawn should not be cut too often to obtain the best mowing result. Use the timer function (see 6.3 *Timer on page 44*) to avoid a downtrodden lawn and to get the maximum service life from the robotic lawnmower. When setting the timer, calculate that the robotic lawnmower mows about the number of square meters per hour and day listed below:

Work capacity		
	Automower®	
	310	315
m ² per hour and day	56	68

For example; If the working area is 800 m² the robotic lawnmower must operate for about:

	Automower®	
	310	315
Hours per day	15	12

The time is approximate and depends for instance on grass quality, blade sharpness and battery age.

IMPORTANT INFORMATION

Use the timer to avoid mowing when there are usually children, pets and anything else about that could be hurt or damaged by the rotating blades on the lawn.

The factory setting is that the robotic lawnmower will operate around the clock seven days a week. If the size of the working area allows it, the quality of the grass can be further improved if it is cut every other day instead of a few hours every day. In addition, the grass benefits from resting completely during at least a three-day period once a month.

The maximum capacity is only obtained when the robotic lawnmower is allowed to mow around the clock seven days a week.

	Automower®	
	310	315
Maximum capacity, m ²	1000	1500

USE

4.3 Standby

The robotic lawnmower has a built-in standby period according to the Standby time table. The standby period provides a good opportunity to e.g. water or play games on the lawn.

	Automower®	
	310	315
Standby time, hours per day	6	2

Example 1

The times used in this example are applicable to Automower® 310 but the principle is the same for Automower® 315.

Work period 1: 00:00 - 18:00.
Work days: All days.

The factory setting ensures that the robotic lawnmower begins cutting the lawn at 00.00. The mower is parked in the charging station from 18.00 and rests until it starts cutting again at 00.00.

If the timer setting is divided into two work periods, the standby period can be divided into a number of periods. The total standby time must however be at least 6 hours.

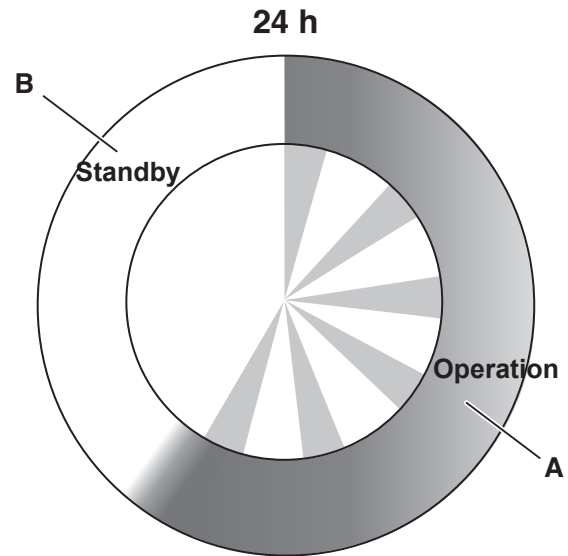

3018-245

	Automower® 310
Operating, A = Max	18 h
Charging / Standby, B = Min	6 h

Example 2

The times used in this example are applicable to Automower® 310 but the principle is the same for Automower® 315.

Work period 1: 08:00 - 16:00.
Work period 2: 20:00 - 23:00.
Work days: All days.

The robotic lawnmower will operate for the times specified in the work periods as the total operating time is 11 hours and does not exceed the maximum of 18 hours.

	Automower® 310
Max. operating time	18 h
Min. standby time	6 h
Area / hour / day	56 m ²

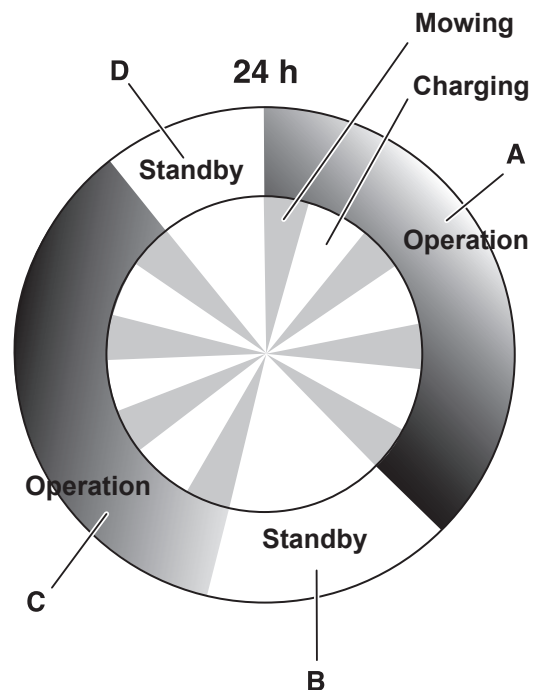

3018-246

	Automower® 310
Operation, A + C = Max	18 h
Charging/Standby, B + D = Min	6 h

USE

4.4 Starting

1. Press the **STOP** button to open the control panel hatch.
2. Set the main switch to position *1*.
3. Enter the PIN code.
4. Push the **START** button.
5. Make the required operation selection. See *5.1 Operation selection Start on page 40*.
6. Shut the hatch within 10 seconds.

If the robotic lawnmower is parked in the charging station, it will only leave the charging station when the battery is fully charged and if the timer is set to allow the mower to operate.

Before the blade disc starts a warning beep can be heard consisting of 5 short beeps for 2 seconds.

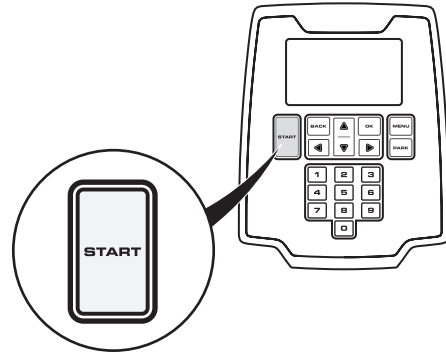

3012-1204

4.5 Stopping

1. Press the **STOP** button.

The robotic lawnmower stops, the blade motor stops and the control panel hatch opens.

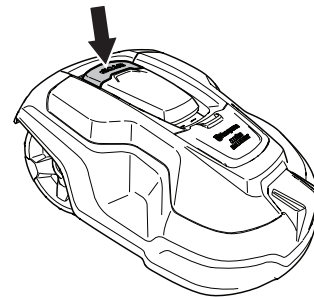

3012-1381

4.6 Switching off

1. Press the **STOP** button.
2. Set the main switch to position *0*.

Always switch the robotic lawnmower off using the main switch if it requires maintenance or if the robotic lawnmower must be moved outside the working area.

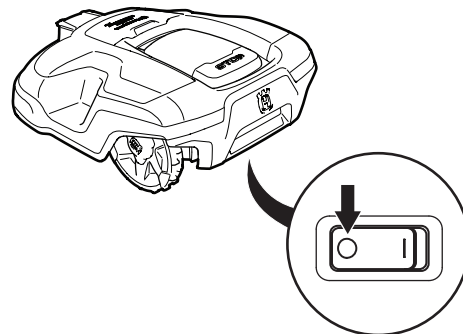

3012-1301

USE

4.7 Adjusting the cutting height

The cutting height can be varied from MIN (2 cm) to MAX (6 cm) in nine stages.

During the first week after a new installation, the cutting height must be set to MAX to avoid damaging the loop wire. After this, the cutting height can be lowered one step every week until the desired cutting height has been reached.

If the grass is long, allow the robotic lawnmower to start mowing at the MAX cutting height. Once the grass is shorter, you can gradually lower the cutting height.

To adjust the cutting height:

1. Press the **STOP** button to stop the robotic lawnmower,
2. Open the cutting height adjustment hatch.
3. Turn the knob to the required position. The selected position is the marking on the body that aligns with the arrow on the knob. Turn clockwise to increase the cutting height. Turn counter-clockwise to decrease the cutting height.
4. Close the hatch.

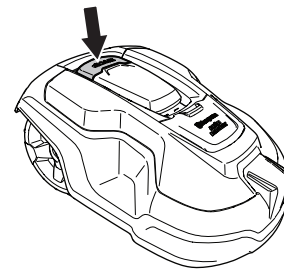

3012-1381

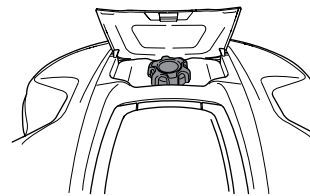

3012-1348

IMPORTANT INFORMATION

During the first week after a new installation, the cutting height must be set to MAX to avoid damaging the loop wire. After this, the cutting height can be lowered one step every week until the desired cutting height has been reached.

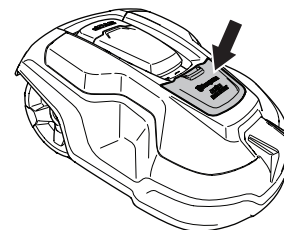

3012-1303

CONTROL PANEL

5 Control panel

All forms of commands and settings for the robotic lawnmower are made via the control panel. All functions are accessed via a number of menus.

The control panel consists of a display and a keypad. All information is shown on the display and all input is done using the buttons.



3012-1094

When the stop button has been pressed and the hatch is opened, the start page is displayed showing the following information:

- Operating information, e.g. *MOWING*, *PARKED* or *TIMER*. If the stop button is pressed when the robotic lawnmower is running, what it did just before it was stopped e.g. *MOWING* or *SEARCHING* is displayed. The text *READY* is displayed if the robotic lawnmower is not in any specific operating mode, e.g. if the main switch has just been turned on.
- Date and clock show the current time.
- The ECO symbol is displayed if the robotic lawnmower is set in ECO mode.
- The black clock symbol (A) indicates when the mower is not allowed to mow due to a timer setting. If the mower is not allowed to mow due to *Weather timer*, symbol (B) is shown (not applicable for Automower® 310). If the operation mode *Override timer* is chosen, symbol (C) is shown.
- The battery status shows the remaining battery charge. If the robotic lawnmower is loading, a flash is also shown over the battery symbol (D). If the robotic lawnmower is placed in the charging station without charging, (E) is shown.
- The number of operating hours indicates the number of hours since the day of manufacture that the robotic lawnmower has been in operation. The time that the robotic lawnmower has spent mowing or searching for the charging station is counted as operating time.
- If the function Profiles is used (not applicable for Automower® 310), the name of the active profile will be shown. A star next to the name indicates that the profile has unsaved changes.



3012-1426



3012-1379

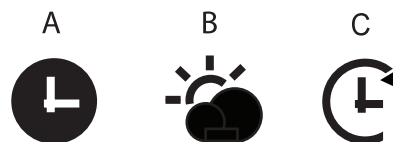

3018-1405



3012-569



CONTROL PANEL

The keypad consists of six groups of buttons:

- The **START** button is used to activate the robotic lawnmower. This is normally the last button to be pressed before closing the display hatch.
- The **Back** and **OK** buttons are used to navigate in the menu. The **OK** button is also used to confirm settings in the menu.
- The arrow keys are used to navigate in the menu but also to make selections in certain setting options.
- The **MENU** button is used to go to the main menu.
- The **PARK** button is used to send the robotic lawnmower to the charging station.
- Numbers are used to enter settings, for example, PIN code, time or exit direction. They can also be used to enter a number series for shortcuts to the various menus. See 6.1 Main menu on page 42.

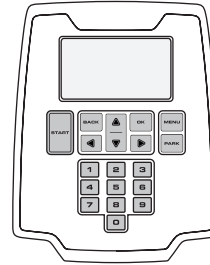

3012-1094

5.1 Operation selection Start

When the **START** button has been pressed the following operation selections can be selected.

Main area

The standard, automatic operating mode where the robotic lawnmower mows and charges continually.

Secondary area

The *Secondary area* operating mode is used when mowing secondary areas where the robotic lawnmower cannot travel to the charging station automatically. For information about secondary areas, see 3.4 *Installation of the boundary wire on page 22.*

Selecting *Secondary area* will cause the robotic lawnmower to mow until the battery is empty.

If the robotic lawnmower charges in the *Secondary area* mode, it will fully charge, drive out about 50 cm and then stop. This indicates that it is charged and ready to start mowing.

If the main working area has to be cut after charging, it is appropriate to switch the operation selection to *Main area* before placing the robotic lawnmower in the charging station.

Override timer

Any timer settings made can be temporarily overridden by selecting *Override timer*. It is possible to override the timer for 24 h or 3 days.

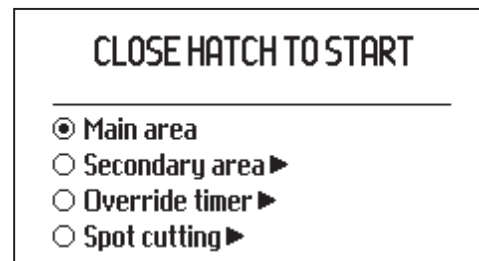

3012-1429





CONTROL PANEL

Spot Cutting

Not applicable for Automower® 310.

Spot cutting means the robotic lawnmower will work in a spiral pattern in order to cut the grass in the area where it was started. When this is done, the robotic lawnmower will automatically switch to *Main Area* or *Secondary Area*.

This function is useful for quickly mowing an area where the grass has been mown less than in other parts of the garden.

The *Spot Cutting* function is activated with the **START** button. You can select how the robotic lawnmower should continue to work once mowing is finished by pressing *Right Arrow* and then specifying *On Main Area* or *On Secondary Area*.

5.2 Operation selection Parking

When the **PARK** button is pressed the following operation selections can be chosen.

Park until further notice

The robotic lawnmower stays in the charging station until another operating mode is selected by pressing the **START** button.

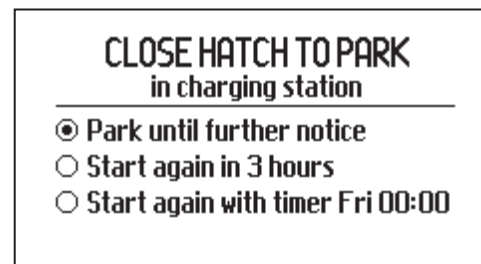

3012-1430

Start again in 3 hours

The robotic lawnmower stays in the charging station for three hours and then returns automatically to normal operation. This operation selection is suitable when there is a need to pause operation, e.g. for temporary irrigation or for games on the lawn.

Start with next timer

The robotic lawnmower stays in the charging station until the next Timer setting permits operation. This operation selection is suitable if one wishes to cancel an ongoing mowing cycle and allow the robotic lawnmower to stay in the charging station until the next day.

5.3 Main switch

Set the main switch in the *1* position to start the robotic lawnmower.

Set the main switch in the *0* position when the robotic lawnmower is not in use or work is being carried out on the blade disc.

When the main switch is set in the *0* position the motors on the robotic lawnmower cannot start.

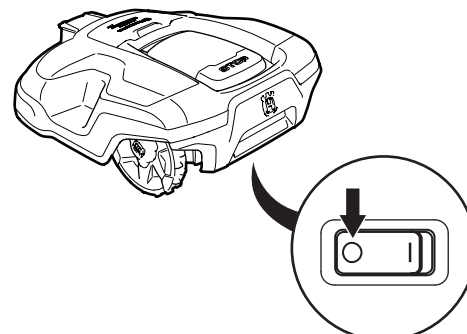

3012-1301

English - 41





MENU FUNCTIONS

6 Menu functions

6.1 Main menu

The main menu consists of the following options:

- *Timer*
- *Security*
- *Messages*
- *Weather timer (only for Automower® 315)*
- *Installation*
- *Settings*
- *Accessories*

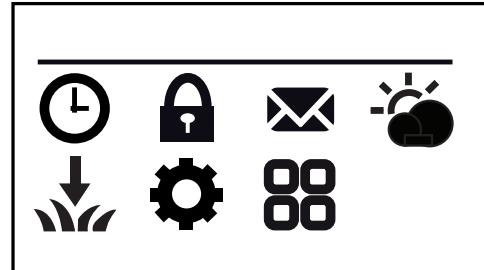

Automower 315

3018-1402

There are a number of submenus under each option. You can access all the functions to set the robotic lawnmower settings via these.

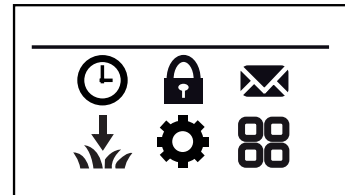

Automower 310

3018-1403

Browse between menus

Browse through the main menu and submenus with the help of the arrow keys. Enter values and times using the number keys and confirm each selection with the multi-choice button marked **OK**. Press **BACK** to go up a step in the menu or press the **MENU** button to go directly to the main menu.



3012-1094

Submenus

Certain submenus contain a box that can be checked. This is used to select which option(s) is/are selected or if a function is activated/deactivated. Check or uncheck the box by pressing **OK**.

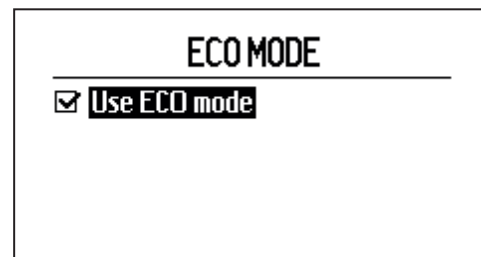

3012-1407









MENU FUNCTIONS

6.2 Menu structure

The following table summarises the menu selections found in the main menu. The following chapter provides more detailed information about how each function is used and which setting options are available.

Use the arrow keys to browse the menu. Confirm selections with **OK**.

	<p><i>Timer</i></p> <p>The lawn should not be cut too often to obtain the best mowing result. Consequently, it is important to limit the operating time using the timer function if the working area is less than the robotic lawnmower's working capacity. The timer function is also an ideal tool to control which periods the robotic lawnmower should not mow, for example, when the children are playing in the garden.</p>
	<p><i>Security</i></p> <p>In this menu, settings relating to security and the connection between the robotic lawnmower and the charging station can be made. There are three security levels to choose from but it is also possible to define your own combination of security functions.</p>
	<p><i>Messages</i></p> <p>Historical, fault and information messages can be read in this menu. Regards some of the most common fault messages, there are tips and advice to help you rectify the fault. See 9.1 Fault messages on page 74.</p>
	<p><i>Weather timer</i></p> <p>Only applicable for Automower® 315.</p> <p>This function allows the robotic lawnmower to automatically adjust its mowing times based on how quick the lawn grows. When the weather is good for grass growth, the robotic lawnmower mows more often and when grass growth is slower the robotic lawnmower will automatically spend less time on the lawn.</p>
	<p><i>Installation</i></p> <p>This menu is used to steer the robotic lawnmower to remote parts of a working area and to control how the robotic lawnmower searches for the charging station. For many working areas the factory settings can be kept, i.e. allow the robotic lawnmower itself to combine the various search methods and the underlying settings.</p>
	<p><i>Settings</i></p> <p>This selection allows you to make changes to the general robotic lawnmower settings such as date and time.</p>
	<p><i>Accessories</i></p> <p>This menu handles the settings for accessories assembled on the mower. Contact your dealer for information on what accessories are suitable for your robotic lawnmower.</p>

MENU FUNCTIONS

6.3 Timer

The lawn should not be cut too often to obtain the best mowing result. Consequently, it is important to limit the operating time using the timer function if the working area is less than the mower's working capacity. When the robotic lawnmower is allowed to mow too often, the lawn may appear flattened and the robotic lawnmower is subjected to unnecessary wear.

The timer function is also an ideal tool to control which periods the robotic lawnmower should not mow, for example, when the children are playing in the garden.

Maximum performance is obtained when the timer is turned off and the robotic lawnmower is allowed to mow around the clock seven days a week. The operating hours and days are graphically displayed on the robotic lawnmower's display. Active mowing per day is illustrated by a black bar. The rest of the time, the robotic lawnmower is parked in the charging station.

The factory setting is that the timer is inactive and the robotic lawnmower will operate around the clock seven days a week. This is normally a suitable setting for a working area corresponding to the maximum performance.

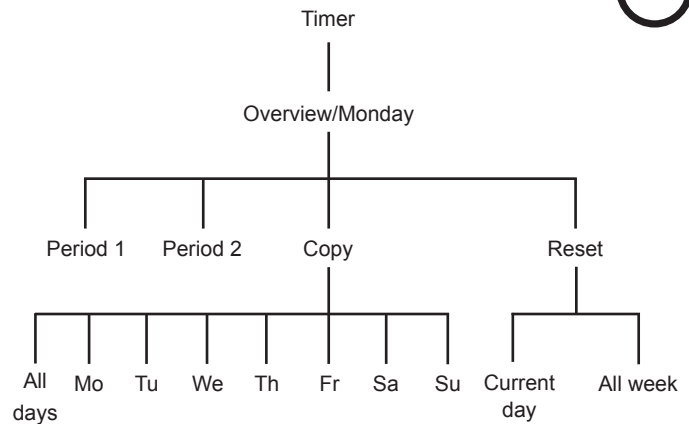

3012-1431

	Automower®	
	310	315
Maximum capacity, m²	1000	1500

When setting the timer, calculate that the robotic lawnmower mows about the number of square meters per hour and day listed in table *Work capacity* See 4.2 Using the timer on page 35.

The tables below provides suggestions for different timer settings depending on garden size. The table can be used to set the operating time. The times should be seen as indicative, they may need to be adjusted to suit the garden. Use the table as follows:

- Find a work area that closest matches the garden's area.
- Select an appropriate amount of work days (for some work areas 7 days may be needed).
- Work hours per day shows how many hours a day the robotic lawnmower will be allowed to work for the selected amount of work days.
- Suggested time interval shows a time interval that corresponds to the required work hours per day.

It is possible to configure two work periods a day. There can be unique work periods in each day, but it is also possible to copy the current day's work period to all the other days.

MENU FUNCTIONS

Automower® 310			
Work area	Work days per week	Work hours per day	Suggestion of time interval
250 m ²	5	6,5 hours	07:00 - 13:30
	7	4,5 hours	07:00 - 11:30
500 m ²	5	12,5 hours	07:00 - 19:30
	7	9 hours	07:00 - 16:00
750 m ²	5	18 hours	06:00 - 24:00
	7	13,5 hours	07:00 - 20:30
1000 m ²	7	18 hours	06:00 - 24:00

Automower® 315			
Work area	Work days per week	Work hours per day	Suggestion of time interval
250 m ²	5	5,5 hours	07:00 - 12:30
	7	4 hours	07:00 - 11:00
500 m ²	5	10,5 hours	07:00 - 17:30
	7	7,5 hours	07:00 - 14:30
750 m ²	5	15,5 hours	07:00 - 22:30
	7	11 hours	07:00 - 18:00
1000 m ²	5	21 hours	03:00 - 24:00
	7	15 hours	07:00 - 22:00
1250 m ²	7	18,5 hours	05:30 - 24:00
1500 m ²	7	22 hours	02:00 - 24:00

Edit day

To edit the timer settings, first select the day to edit from the *Overview* screen using the arrow left and arrow right followed by **OK**.

Up to two time intervals per day can be entered. To enter an interval for Period 1, first make sure that the check box next to Period 1 is checked. To check/uncheck select the check box and press **OK**. Enter the desired times using the numeric keypad.

If two intervals are desired, first check the check box next to Period 2 then enter times as above. Two intervals can be useful for enabling the lawn for other activities during certain hours, for example by entering Period 1: 00:00-15:00 and Period 2: 21:00-24:00. The mower will then be parked in the charging station between 15:00 and 21:00.

To disable mowing during the whole day, uncheck both periods.

Copy

Use this function to copy the current day settings to other days.

Use the up and down arrow keys to move the cursor between days. The times will be copied to the days that are marked with **OK**.

MONDAY

Period 1 : 10:00 - 15:00

Period 2 : --:--:--:--:--

Copy
Reset

3012-1432

COPY MONDAY TO

All days **Thursday**

Monday **Friday**

Tuesday **Saturday**

Wednesday **Sunday**

3012-1406



MENU FUNCTIONS

Reset

This function resets the timer to the factory setting, where the robotic lawnmower is allowed to operate 24 hours a day every day.

Current day

This resets the day that is selected in the tab system.

The factory setting is that the robotic lawnmower is allowed to operate 24 hours a day.

All week

This resets all days in the week.

The factory setting is that the robotic lawnmower is allowed to operate 24 hours a day every day.

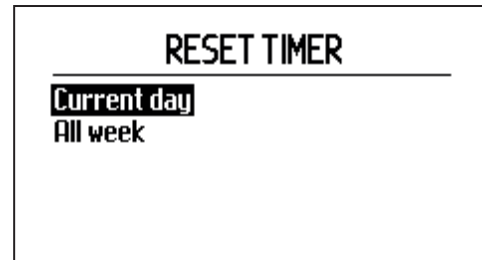

3012-1408

6.4 Security

Through this selection, settings relating to security and the connection between the robotic lawnmower and the charging station can be made.



Security level

There are three security levels to choose from. Use the down and up arrow keys to select a security level.

Low and medium security prohibits access to the robotic lawnmower if the PIN code is unknown. High security also includes a warning that beeps if the correct PIN code is not entered after a designated time period.

If the wrong PIN code is entered 5 times in succession the robotic lawnmower is blocked for a time. The blockage time is extended for every new incorrect attempt.

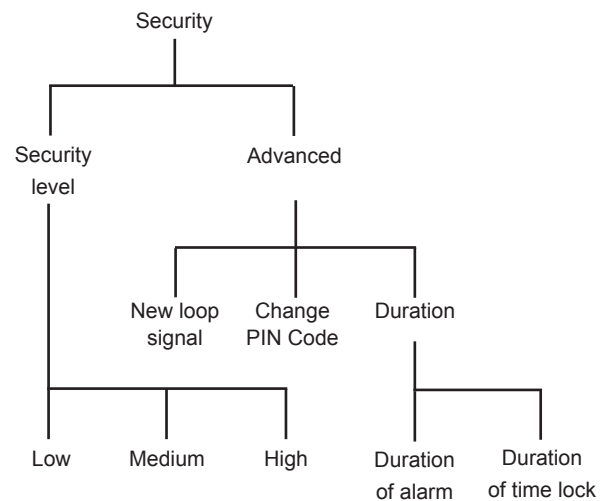

Function	Low	Medium	High
Time lock	X	X	X
PIN request		X	X
Alarm			X

Time lock

This function means that the robotic lawnmower cannot be started after 30 days without first entering the correct PIN code. When the 30 days has passed the robotic lawnmower will continue to mow as normal, but the *Enter PIN code* message appears when the hatch is opened. Enter your code again and press **OK**.

After this, the selected PIN code must be entered every time the main switch is set to 1.

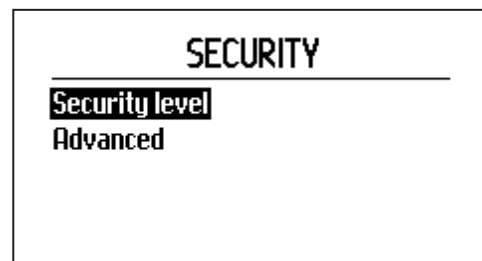

3012-1409



MENU FUNCTIONS

PIN request

This function means that the robotic lawnmower requests a PIN code each time the hatch is opened. The correct PIN code must be entered to use the robotic lawnmower.

Alarm

This function means that an alarm sounds if the PIN code is not entered within 10 seconds after the **STOP** button has been pressed or the robotic lawnmower has been lifted up for any reason. A ticking noise indicates that the PIN code must be entered to prevent triggering the alarm. The alarm can be turned off at any time by entering the correct PIN code.

Advanced

New loop signal

The loop signal is randomly selected to create a unique link between the robotic lawnmower in question and the charging station. In rare cases, there may be a need to generate a new signal, for instance if two adjacent installations have a very similar signal.

1. Place the robotic lawnmower in the charging station to which the robotic lawnmower is to be connected.
2. Select *New loop signal* in the menu and press OK.

Press **OK** and await confirmation that the loop signal has been generated. This normally takes about 10 seconds.

Change PIN code

Enter the new PIN code and press **OK**. Confirm by entering the same code again and pressing **OK**. When the PIN code is changed, the message *PIN code changed* appears in the display momentarily.

Make a note of the new PIN code on the designated line in *Memo* on page 2.

Duration of alarm

When *Alarm* is activated there is also the possibility to select how long the alarm signal should last. A figure between 1 and 20 minutes can be selected.

Duration of time lock

A time lock can be set to decide how many days will pass before the PIN must be entered before use. 1-90 days can be selected.



MENU FUNCTIONS

6.5 Messages



Historical and information messages can be read using this function. Regards some of the most common fault messages, there are tips and advice to help you rectify the fault. See 9.1 *Fault messages on page 74*.

Fault messages

If the robotic lawnmower is disrupted in any way e.g. gets stuck under a fallen branch a message is shown in the lawnmower's display relating to the disruption and the time it happened.

If the same fault message is repeated several times, this may indicate that an adjustment to the installation or the robotic lawnmower is required. See 9.1 *Fault messages on page 74* for more information on possible reasons for each message.

The list contains the latest 50 fault messages sorted by date with the last incident to occur first on the list.

The date and time when the fault messages are displayed can be shown by selecting a fault message and pressing the **OK** button.

Tips and advice to help you rectify the fault, are also displayed.

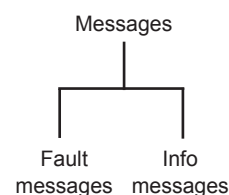

Info messages

Messages shown in the display not caused by an actual fault are instead saved under the *Info messages* heading. Examples for such messages is *Slope too steep*. See 9.1 *Fault messages on page 74* for more information on possible reasons for each message.

The list contains the latest 50 fault messages sorted by date with the last incident to occur first on the list.





MENU FUNCTIONS

6.6 Weather timer



Not applicable for Automower® 310.

This function allows the robotic lawnmower to automatically adjust its mowing times based on how quick the lawn grows. When the weather is good for grass growth, the robotic lawnmower mows more often and when grass growth is slower the robotic lawnmower will automatically spend less time on the lawn.

The robotic lawnmower will however not operate longer than the time that may be configured in the timer settings. For optimal weather timer performance, it is recommended when setting the timer to only de-select the times when the robotic lawnmower must not operate. Other times should be made available for the weather timer.

When the weather timer is activated, the robotic lawnmower needs time to decide what the optimal mowing time is for the working area in question. For this reason it can take a number of days before the mowing results are optimal.

When the weather timer is activated, it is very important to regularly check that the blade disc is clean and that the blades are in good condition. Any grass twisted around the blade disc shaft or blunt blades can affect how the weather timer functions.

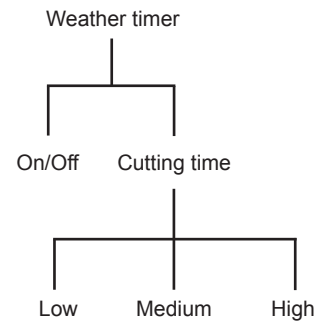

Weather timer

To activate the weather timer: check the box by pressing OK.

Cutting time

If the mowing results are not optimal when using the Weather timer, Cutting time settings may need adjusting.

To adjust the Cutting time: place the cursor by Cutting time and use the right and left arrow keys to increase or decrease the cutting time in three preset intervals.

The longer cutting time that is chosen, the longer the robotic lawnmower will be allowed to work.

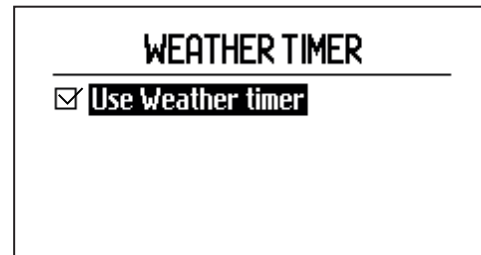

3012-1410



MENU FUNCTIONS

6.7 Installation

This menu function is used to steer the robotic lawnmower to remote parts of a working area and control how the robotic lawnmower searches for the charging station. For many working areas there is no need to alter the factory settings i.e. allow the robotic lawnmower itself to combine the various search methods and the underlying settings.

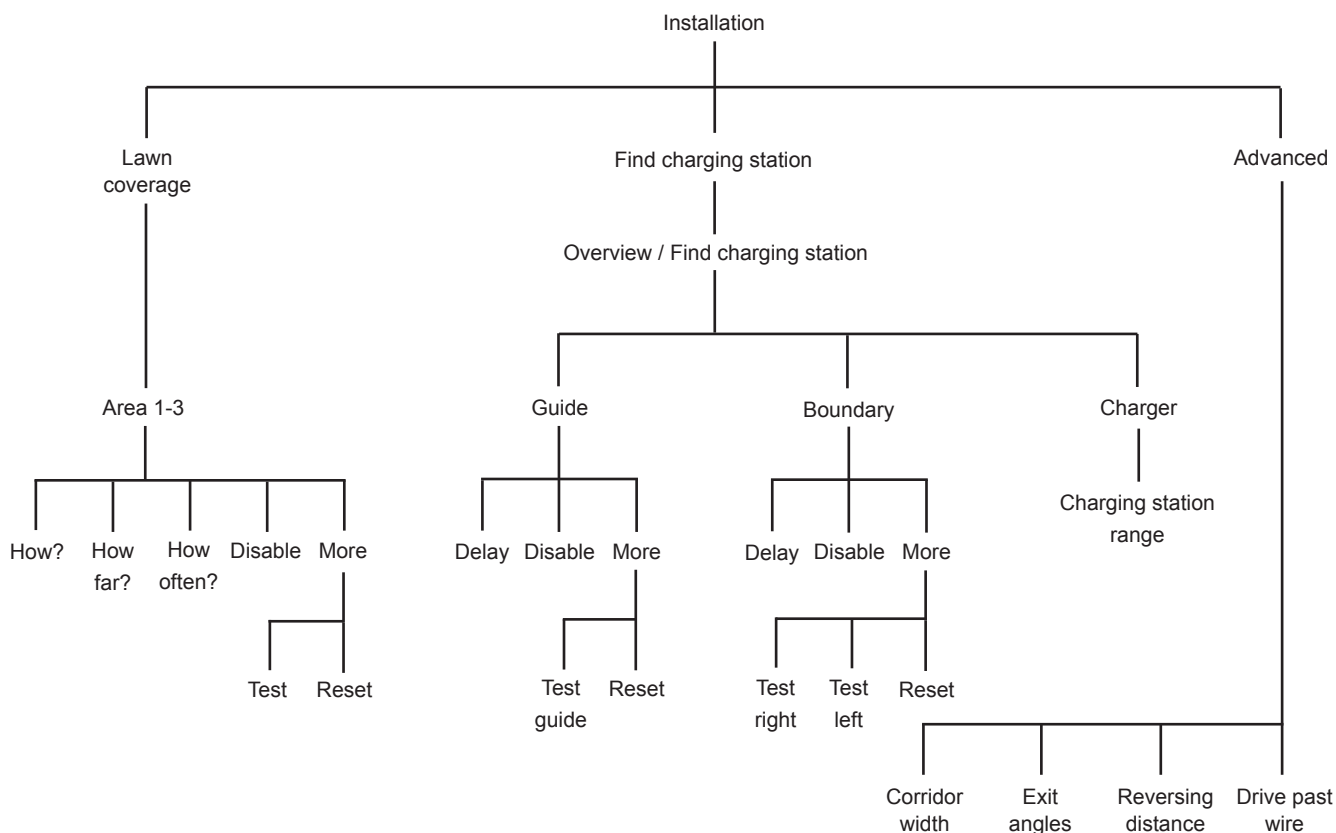

Lawn coverage

This menu function is used to steer the robotic lawnmower to remote parts of a working area. This important function is used to maintain an even mowing result in the entire working area. In very complex gardens with for instance many areas which are joined by narrow passages, the mowing result can be improved by making a number of manual settings as described below.

The factory settings allow the robotic lawnmower to follow the guide wire 300 metres in 20% of the times it leaves the charging station.

Area 1	Area 2	Area 3
300m	300m	100m
20%	40%	20%

3012-1417

Overview

Up to three remote areas can be set. A number of unique selections are required to allow the robotic lawnmower to reach the remote area.

Select an area using the left and right arrow keys followed by **OK** to alter the settings.

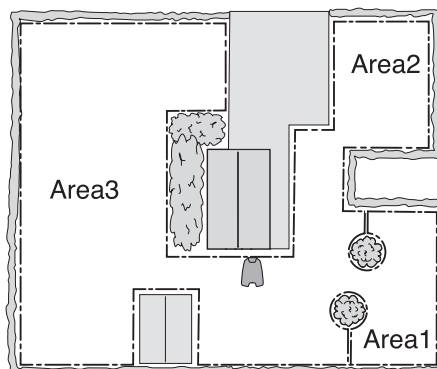

3023-017



MENU FUNCTIONS

Area X > How?

Specify to the right, left or Guide depending on which direction the area lies from the charging station. The direction (right or left) is counted as that seen facing the charging station.

Use the right and left arrow keys to alternate between the different options.

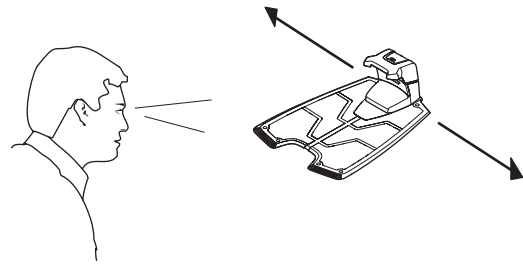

3012-1100

Area X > How far?

Enter the distance in metres along the current wire from the charging station to the remote area where the robotic lawnmower begins mowing.

Use the number keys to specify the distance in metres.

Tip! Use the *Test* function to determine how far it is to the remote area. The distance, stated in metres, will be shown in the lawnmower display when **STOP** has been pressed. See *Area X > More > Test* on page 51. The measured distance shown in the display can be saved directly to the selected remote area. Any current value will be overridden by the new measured distance.

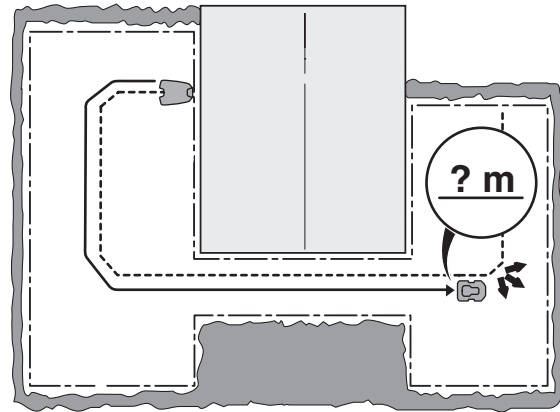

3023-018

Area X > How often?

How often the robotic lawnmower must be steered to the remote area is selected as a proportion of the total number of times it leaves the charging station. At all other times, the robotic lawnmower starts to mow at the charging station.

Select the percentage that corresponds to the size of the remote area relative to the total working area. If the remote area is for instance half of the total working area, 50% must be selected. A lower figure must be specified if the remote area is smaller. If more areas are used, take into account that the total figure cannot exceed 100%.

Compare with the examples in *7 Garden examples* on page 64.

Use the number keys to specify share as a percentage.

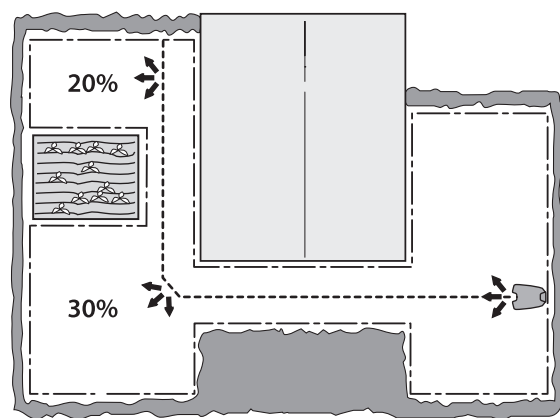

3023-019

Area X > Disable/Enable

Each area can be disabled and enabled without having to reenter the settings. Select Disable/Enable and press **OK**.





MENU FUNCTIONS

Area X > More > Test

Testing selected settings can be seen as a natural part of the installation.

Using the *Test* function, the robotic lawnmower travels the farthest distance from the loop allowed by the selected corridor width.

To test the selected settings:

1. Place the robotic lawnmower in the charging station.
2. Use the down and the right/left arrow keys to select the area to be tested from the Overview screen. Press **OK**.
3. Select More and press **OK**.
4. Select Test and press **OK**.
5. Press **START** and close the display hatch.
6. The robotic lawnmower will now leave the charging station and begin following the specified loop toward the remote area. Check that the robotic lawnmower can follow the loop all along the required distance.
7. The test is approved when the robotic lawnmower can follow the selected loop to the required starting point without any problem.

How to measure the distance to a remote area:

1. Park the robotic lawnmower in the charging station.
2. In the *Area X > How far?* menu function, enter a distance which beyond any doubt exceeds the real figure. The maximum distance that can be entered is 500 metres.
3. Select *Area X > More > Test* and press **OK**.
4. Press **START** and close the display hatch.
5. Press **STOP** at the required position. The distance is now shown in the display. This figure can now be saved in *Area X > How far?*.

Reset

An individual area setting can be reset to the factory setting using this function. To reset an area setting, select *Area X* using the left right arrow keys followed by **OK**. Select *More* and press **OK**. Select *Reset* and press **OK**.

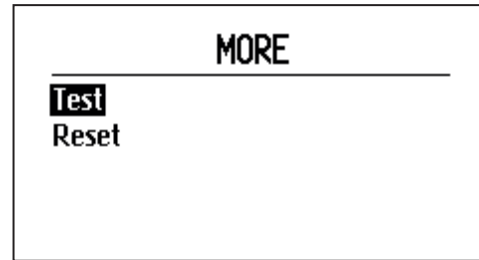

3012-1411





MENU FUNCTIONS

Finding the charging station

The robotic lawnmower can be set to search for the charging station in one or more of the following three ways: *Guide*, *Boundary loop* and *Charging station*. The factory settings are that these three search options are automatically combined to find the charging station as quickly as possible but also with a minimum risk of tracks forming.

In very complex gardens e.g. with many areas joined by narrow passages, the amount of time required to find the charging station is decreased by carrying out a number of the manual setting outlined below.

The robotic lawnmower always starts the search for the charging station using an irregular search method.

When the robotic lawnmower still cannot find the charging station after a specific period of irregular searching, it also starts to search for the guide wires and after a further period also the boundary wire to follow one of them into the charging station instead. This time is specified in minutes and is known as delay time.

Example:

3 minute delay for Guide and 11 minutes for the boundary loop. The robotic lawnmower then searches irregularly for 3 minutes and then searches for the guide wires for 8 minutes. If it has not found a guide wire after this period, the robotic lawnmower now also searches for the boundary loop.

It is possible of course to specify the same delay time for both the guide wires and boundary loop, for instance 5 minutes. The robotic lawnmower then searches irregularly for 5 minutes and when it does not find the charging station, it continues to search either by following the guide wires or the boundary loop, depending on which one it reaches first.

In general a long delay time decreases the risk of tracks forming (the robotic lawnmower will find the charging station more often through irregular searches) but gives longer search times. A short delay time gives the opposite effect, i.e. short search times with increased risk of tracks forming along the guide wires and/or boundary wires.

Overview

This function summarises the selected settings for each search method. To edit the settings for a method, select the method using left and right arrow keys followed by **OK**.

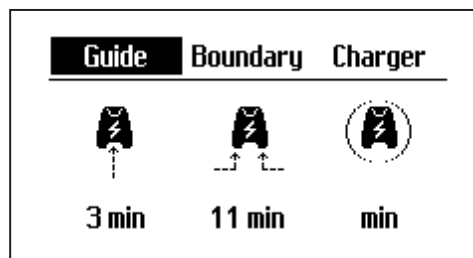

3012-1412

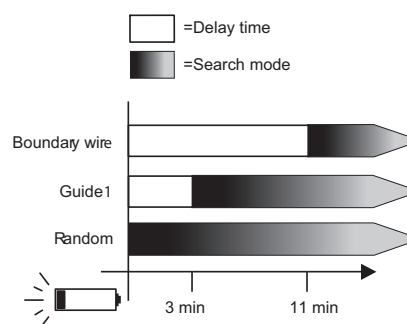



MENU FUNCTIONS

Guide

Use the number keys to enter the delay time.

The delay time is normally specified as a figure between 0 and 10 minutes.

Guide > Disable/Enable

Normally the Guide method does not need to be deactivated even if there is no guide wire installed. To disable the Guide method, select *Disable* and press OK.

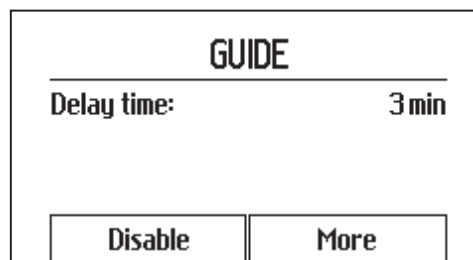

3012-1414

Boundary loop

Use the number keys to enter the delay time.

This time is normally longer than for *Guide* as it is normally better if the robotic lawnmower follows the guide wire home to the charging station. The delay time is normally specified as a figure between 10 and 20 minutes but can be shorter if the guide wire is not installed and it is unlikely that the robotic lawnmower can find the charging station through an irregular search.

If the robotic lawnmower passes a guide wire while following the boundary wire, it will stop searching along the boundary wire and instead start to follow the guide wire into the charging station.

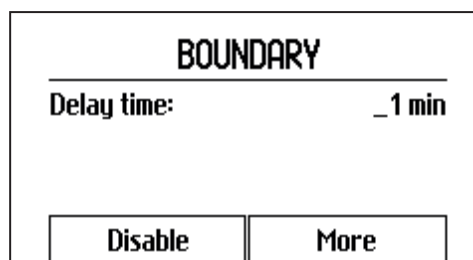

3012-1413

Boundary > Disable/Enable

If it is strictly inappropriate in the installation to follow the boundary loop, the *Boundary method* checkbox has to be deactivated. To disable the boundary method, select *Disable* and press **OK**.

Charging station range

There may be reasons to reduce the range of the charging station in rare cases. It may be necessary if for instance the charging station is placed close to a bush or wall which prevents the robotic lawnmower from docking with the charging station despite making contact with the charging station's signals. In these cases, it is normally better to move the charging station, but if this is not possible, the range of the charging station can be reduced.

IMPORTANT INFORMATION

The charging station's range must only be reduced in exceptional cases. It is normally better to move the charging station to a better place in the working area.

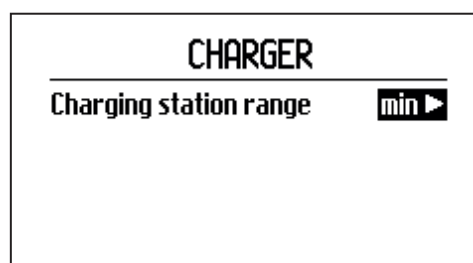

3012-1415

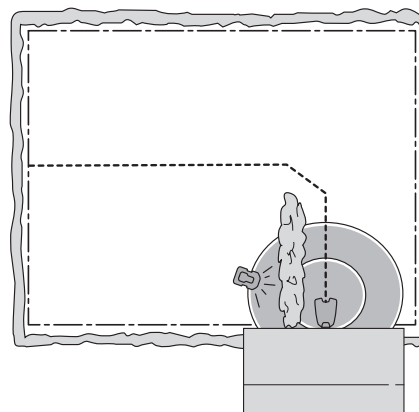

3023-040





MENU FUNCTIONS

Test settings

Testing selected settings can be seen as a natural part of the installation.

To test the selected settings:

1. Place the robotic lawnmower about 3 metres from the wire to be tested (boundary wire or the guide wire), facing the wire.
2. Use the right/left arrow key to select the method to test from the Overview screen.
3. Select More and press **OK**.
4. Select Test Guide under Guide settings, or Test right or Test left under boundary settings, and press **OK**.
5. Press **START** and close the display hatch.

Check that the robotic lawnmower follows the guide wire all the way to the charging station and that it docks with the charging station. The test is approved only if the robotic lawnmower is able to follow the guide wire the entire distance to the charging station and docks at the first attempt. If the robotic lawnmower is unable to dock on the first attempt, it will automatically try again. The installation is not approved if the robotic lawnmower needs two or more attempts to dock with the charging station.

Normal causes as to why the robotic lawnmower cannot follow the wire are that obstacles close to the wire have not been isolated or that the guide wire has not been laid at an angle on a steep slope. Check that the charging station, the boundary wire and the guide wire are installed in accordance with the instructions in chapters 3.2, 3.4 and 3.6.

If manual settings are done, the wrong corridor width may also have been selected.

6. The test is approved when the robotic lawnmower can follow the selected wire to the charging station and dock with it on the first attempt without any problems.

Using *Test*, the robotic lawnmower travels the maximum distance from the wire defined by the selected corridor width.

Reset

The specific settings for each method can be reset to factory default. To reset, select the method using the left and right arrow keys followed by **OK**. Select More, then Reset and press **OK**.



MENU FUNCTIONS

Advanced

Under the *Advanced* heading, there are even more settings relating to the behaviour of the robotic lawnmower. The settings in this menu are only required if additional control of the lawnmower is definitely needed e.g. in very complex gardens. The factory settings are selected in a way that should suit most working areas.

Corridor width

The corridor width is a measure of how far from the guide wire/boundary wire the robotic lawnmower is allowed to travel when it follows this to and from the charging station. The area beside the wire which the robotic lawnmower then uses is called the Corridor.

The aim of operating at varying distances from the wire is to reduce the risk of tracks forming. To reduce the risk of tracks forming, it is recommended to select the widest corridor possible allowed by the size of the working area.

The robotic lawnmower itself adjusts the corridor width according to the size of the working area when following along a guide wire. The inbuilt automatic mechanism allows the robotic lawnmower to vary the distance from the wire depending on where in the working area it is located. It automatically makes the corridor narrower in narrow passages for instance.

The factory settings can be used for many working areas, i.e. the robotic lawnmower itself can use the inbuilt functions to operate in the widest possible corridor. In more complex gardens e.g. where the guide wire is placed close to obstacles which cannot be isolated using the boundary loop, operational safety can be improved by carrying out some of the manual settings outlined below.

Corridor width > Boundary

Corridor width is specified in intervals from 1-9. The first number in the interval specifies the shortest distance to the boundary loop and the second number the longest distance.

The distance the robotic lawnmower maintains from the boundary loop varies depending on the layout of the working area. Use the *Test* function in *Installation > Lawn Coverage > Area X > More > Test* to test the different values.

Use the number keys to specify the required interval.

The factory setting is 3-6.

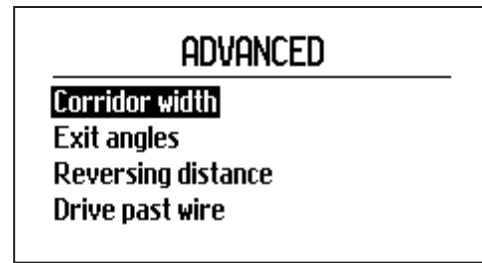

3012-1416

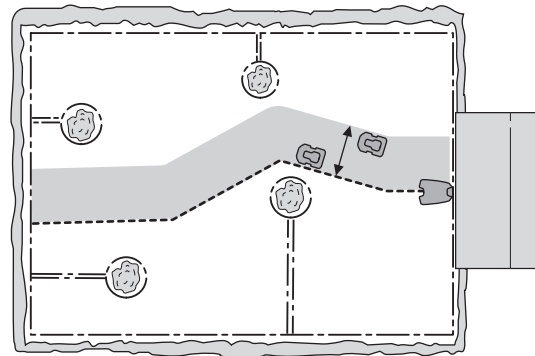

3023-020

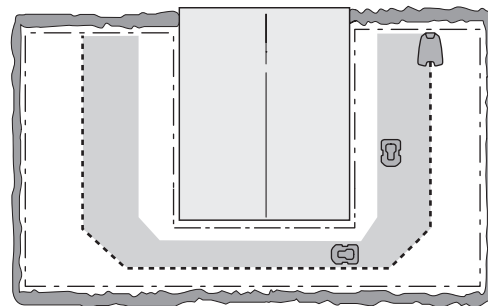

3023-021

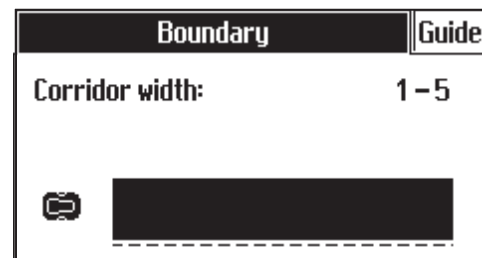

3012-1423



MENU FUNCTIONS

Corridor width > Guide

The function Automatic passage handling will automatically adjust the guide corridor width. If Automatic passage handling is disabled, manual settings need to be entered. The corridor width can be set between 0 and 9.

If value 0 is specified, the robotic lawnmower will straddle the guide wire meaning it runs right over the middle of the guide wire.

Use the arrow keys to specify the required value.

The factory setting is 9.

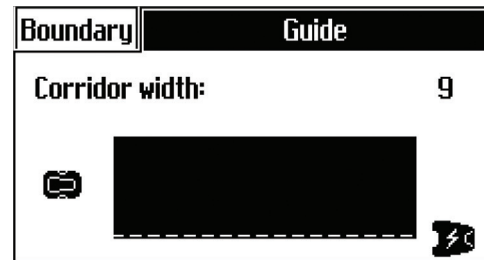

3012-1424

Exit angles

Normally the robotic lawnmower leaves the charging station in a direction within the 90°-270° exit sector. By changing the exit angles, it makes it easier for the robotic lawnmower to reach the largest working area if the charging station is placed in a passage.

Exit angles > Sectors

The robotic lawnmower can be set for one or two exit sectors. If the charging station is placed in a passage, two exit angles, for instance 70° - 110° and 250° - 290°, can be used.

When two exit angles are used, there is a need to also specify how often the robotic lawnmower must leave the charging station in sector 1. This is done using the *Proportion* function by initially specifying a percentage.

For instance the percentage of 75 % means that the robotic lawnmower leaves the charging station in *Sector 1* on 75% of the times and 25% of the times in sector 2.

Use the number keys to specify the required angles in degrees for the sectors and proportion as a percentage.

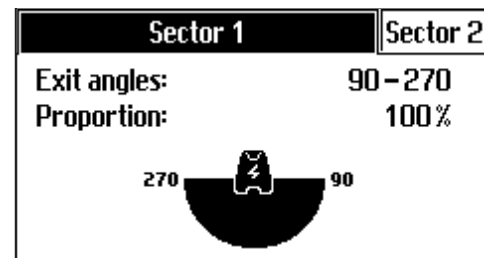

3012-1418

Reversing distance

This functions allows you to control how far the robotic lawnmower has to reverse out from the charging station before it starts mowing. This is a useful function for instance if the charging station is placed way in under a veranda or in another limited space area.

Use the number keys to specify the required reverse distance in centimetres. The factory setting is 60 cm.

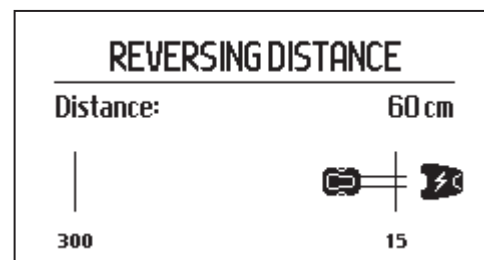

3012-1419



MENU FUNCTIONS

Drive past wire

The front of the robotic lawnmower always passes the boundary wire by a specific distance before the mower turns around. The default distance is 32 cm, but this can be changed if required. A figure between 25 and 50 can be selected.

Note that the distance given is only an approximate value and should be regarded as a guide. In reality, the actual distance the robotic mower passes the boundary wire can vary.

Specify the number of centimetres you want the robotic lawnmower to pass the boundary wire and press **OK**.

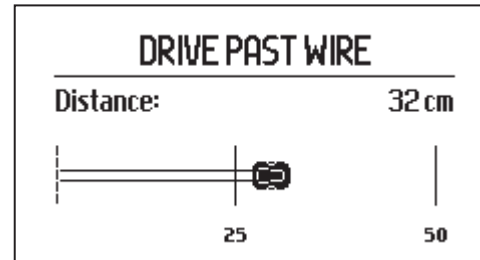

3012-1420





MENU FUNCTIONS

6.8 Settings

This selection allows you to carry out changes to the robotic lawnmower's general settings.

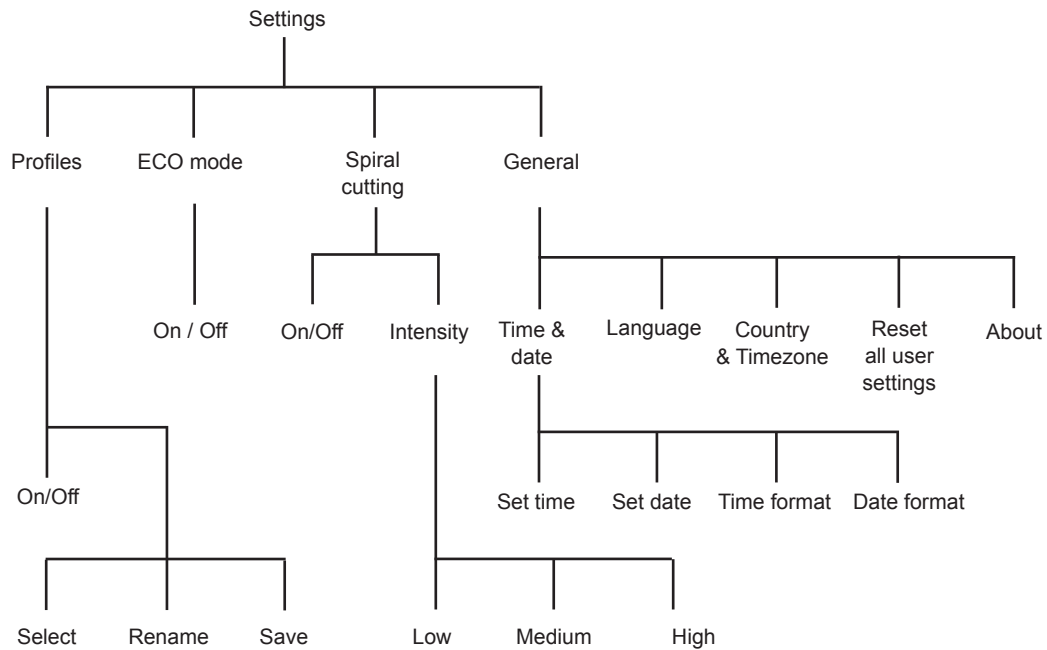
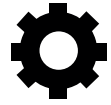

Profiles

Not applicable for Automower® 310.

With the function *Profiles*, different sets of user settings can be saved. This means that the settings can be easily stored and reused if the robotic lawnmower for example will be used in different gardens. Up to three different profiles can be stored.

Save settings to a Profile

- First make the settings in the mower that will be stored in the profile.
- Check *Use Profiles* and press **OK**.
- Select the profile to be stored, move the cursor with the up and down arrow keys.
- Press **OK**.
- Select *Save* and press **OK**, followed by arrow key left and **OK**. All user settings are now stored in the selected profile.
- If settings that are not stored to the profile are made, the symbol * is shown next to the profile name.

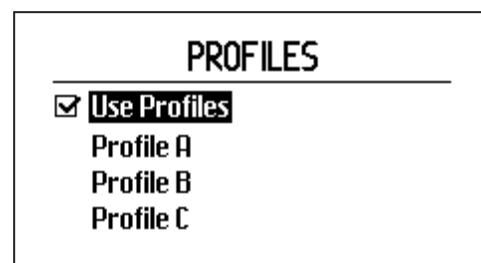

3012-1421

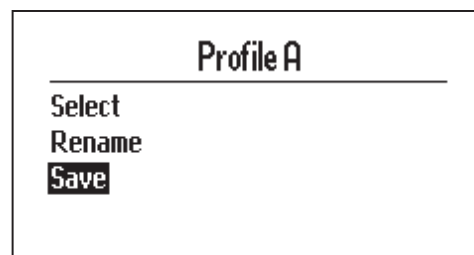

3012-1425



MENU FUNCTIONS

Change the name of a profile

The names of the profiles can be changed, to make it easier to remember what settings are stored in the respective profile.

- Select the profile name to be changed.
- Press **OK**.
- Select *Rename* and press **OK**.
- Move the cursor with the arrow keys. Press **OK** to select a letter. Press **BACK** to save the new name.
- The names of the profiles will be shown in the menu *Settings - Profiles*. The name of the selected profile is also visible on the start screen.

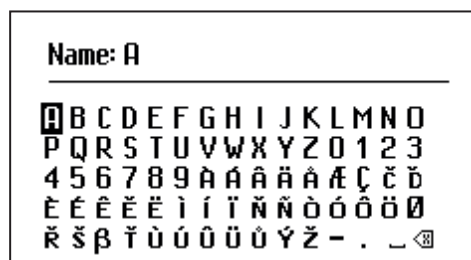

3012-1422

Use a Profile

To activate and use a profile, and thus use the saved settings, the following action must be taken.

- Select the profile to activate.
- Press **OK**.
- Select *Use* and press **OK**.

The robotic lawnmower will now use the settings stored in the profile.

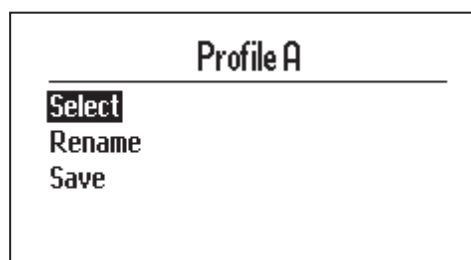

3012-1427

One Automower® for several gardens

The unique connection between the mower and the charging station is saved in the profiles. This enables up to three charging stations to be connected to the same robotic lawnmower.

To connect a new charging station to the robotic lawnmower:

- First save a profile to be used with the original charging station.
- Then set the mower in the new charging station that will be connected to the mower.
- Check *New loop signal*, See 6.4 Security on page 46.
- Save a profile for the new charging station.

To use the robotic lawnmower in the original charging station, the first profile must now be selected. To use the robotic lawnmower in the new charging station, that profile must be selected.



MENU FUNCTIONS

ECO mode

This function automatically turns off the signal in the boundary loop, the guide wires and the charging station when the robotic lawnmower is not mowing, i.e. when the lawnmower is charging or is not allowed to mow due to timer settings.

ECO mode is suitable to use where there is other wireless equipment not compatible with the robotic lawnmower e.g. certain hearing loops or garage doors.

When the loop signal is turned off due to the ECO mode, the indicator lamp in the charging station flashes green. When the indicator lamp flashes green the robotic lawnmower can only be started in the charging station and not out in the working area.

In ECO mode, it is very important to always press the **STOP** button before removing the robotic lawnmower from the charging station. In ECO mode it is otherwise not possible to start the robotic lawnmower. If the lawnmower has been removed by mistake without first pressing the **STOP** button, the lawnmower must be placed back in the charging station and the **STOP** button pressed. Only then can the robotic lawnmower be started inside the working area.

IMPORTANT INFORMATION

Always press the STOP button before removing the robotic lawnmower from the charging station. In ECO mode the robotic lawnmower otherwise will not be started inside the working area.

Select ECO mode and press **OK** to activate ECO mode.

Spiral cutting

If the robotic lawnmower enters an area where it senses the grass is longer than average, it can change the movement pattern. It can then mow in a spiral pattern to faster cut the area of longer grass.

Spiral cutting

Spiral cutting is activated by default, uncheck the box to deactivate.

Intensity

The level of intensity can be adjusted to set how much over the average height the grass has to be for spiral cutting to begin. Low sensitivity means that spiral cutting begins less often. High sensitivity means that spiral cutting begins more often.

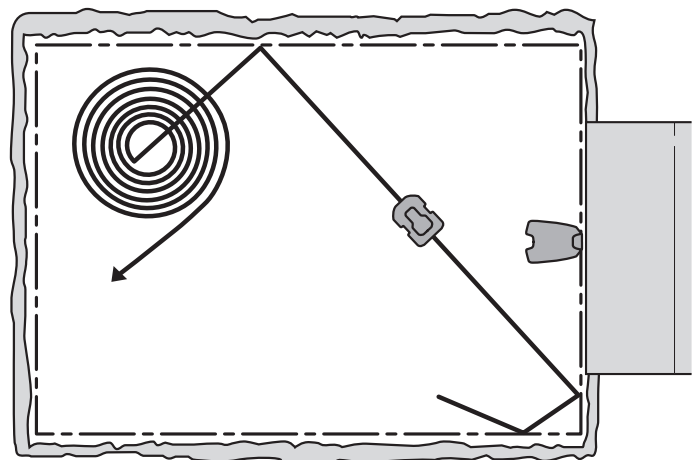

3023-041





MENU FUNCTIONS

General

Set language and time or reset user settings to factory default.

Time & Date

This function allows you to set current time and required time format in the robotic lawnmower.

Time

Enter the correct time and press **OK** to exit.

Time format

Move the cursor to the required time format: 12h/24h
Exit by pressing **OK**.

Date

Enter current date and press **OK** to exit.

Date format

Place the cursor at the required date format:
YYYY-MM-DD (year-month-day)
MM-DD-YYYY (month-day-year)
DD-MM-YYYY (day-month-year)
Exit by pressing **OK**.

Language

Set the language displayed in the menus with this function.

Place the cursor at the required language and press **OK**.

Country & time zone

With this function you can select in what country the robotic lawnmower will work. This setting also affects the time zone adjustment.

Place the cursor at the required country and press **OK**.





MENU FUNCTIONS

Reset all user settings

This function allows you to reset the robotic lawnmower to the default settings it had when it left the factory.

The following settings are not altered:

- Security level
- PIN code
- Loop signal
- Messages
- Date & Time
- Language
- Country

1. Select *Reset all user settings* in the menu and press **OK**.
2. Confirm by pressing **OK**.

About

In the About menu, information about the different mower software versions, model and serial number is available.

6.9 Accessories

This menu is used for the settings related to accessories fitted on the mower. Contact your local dealer for more information on available accessories.

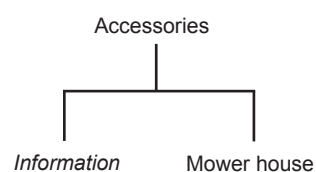

Mower house

This function handles the settings for the mower house.

Avoid collisions with mower house

If this option is selected, the wear on the mower and the house is reduced, but it can result in more uncut grass around the charging station.

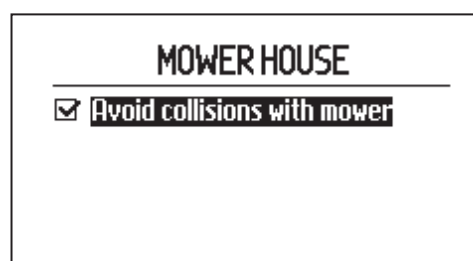

3012-1433





GARDEN EXAMPLES

7 Garden examples

- Installation proposals and settings

Adapting the robotic lawnmower's settings and guide wire positions according to the shape of the garden makes it easier for the robotic lawnmower to frequently reach all parts of the garden and in doing so achieve a perfect mowing result.

Different gardens may require different settings. The following pages outline a number of examples of gardens with installation proposals and settings.

For more detailed information about the different settings, see *6 Menu functions on page 42*.

There is more installation help on www.automower.com.

IMPORTANT INFORMATION

The default setting for the robotic lawnmower has been chosen to work in as many different gardens as possible. The settings only need to be adjusted when special installation conditions exist.



GARDEN EXAMPLES

Installation proposals and settings	
Area	150 m ² . Open and level area.
Timer	<p>Automower® 310 08:00-14:00 Monday, Wednesday, Friday</p> <p>Automower® 315 08:00-13:00 Monday, Wednesday, Friday</p>
Lawn coverage	Factory setting
Find charging station	Factory setting
Remarks	<p>The timer should be used to prevent the grass looking trampled since the area is significantly less than the maximum capacity of the robotic lawnmower.</p> <p>As the area is open and uncomplicated there is no need for a guide wire in this installation.</p>
Area	500 m ² . A number of islands and a 35% slope.
Timer	<p>Automower® 310 08:00-18:30 Monday to Saturday</p> <p>Automower® 315 08:00-16:30 Monday to Saturday</p>
Lawn coverage	Factory setting
Find charging station	Factory setting
Remarks	Lay the guide wire at an angle over the steep slope.

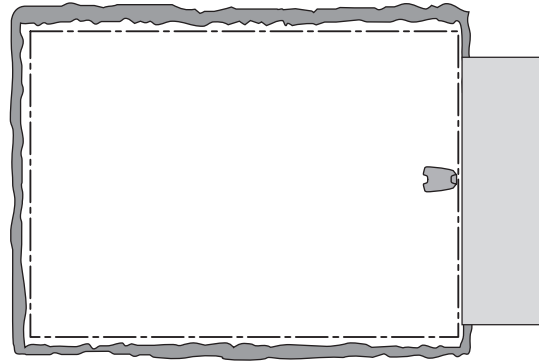

3023-032

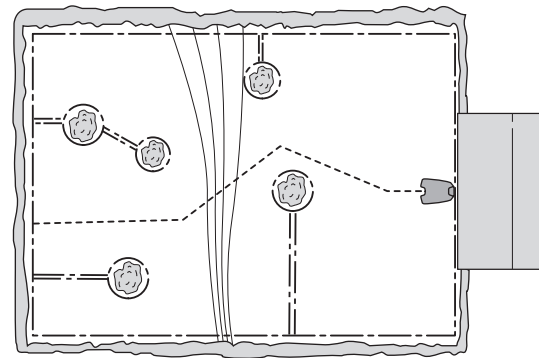

3023-023

GARDEN EXAMPLES

Area	800 m ² . L-shaped garden with charging station installed in the narrow area. Contains a couple of islands.
Timer	<p>Automower® 310 07:00-24:00 Monday to Saturday</p> <p>Automower® 315 08:00-22:00 Monday to Saturday</p>
Lawn coverage	<p>Area 1: How? Guide How far? x m How often? 60%</p>
Find charging station	Factory setting
Remarks	The Proportion (<i>How often?</i>) for Guide must be specified as a value corresponding to the largest part of the working area as most of the working area can easily be reached by the robotic lawnmower following the guide wire out from the charging station.
Area	1,000 m ² . U-shaped garden linked with a narrow passage.
Timer	<p>Automower® 310 06:00-24:00 Monday to Sunday</p> <p>Automower® 315 07:00-24:00 Monday to Saturday</p>
Lawn coverage	<p>Area 1: How? Guide How far? x m How often? 40%</p>
Find charging station	Factory setting
Remarks	The guide wire must be placed along the narrow passage to ensure the robotic lawnmower can with ease locate the left hand side of the working area. The Proportion 40% (<i>How often?</i>) is selected as the left hand area is nearly half of the total area.

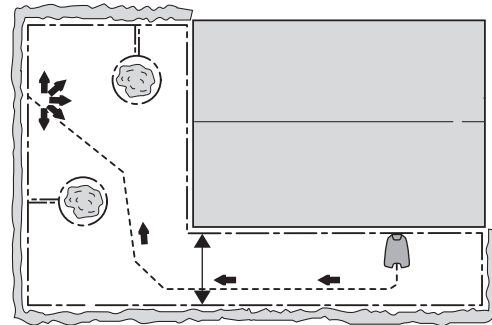

3023-024

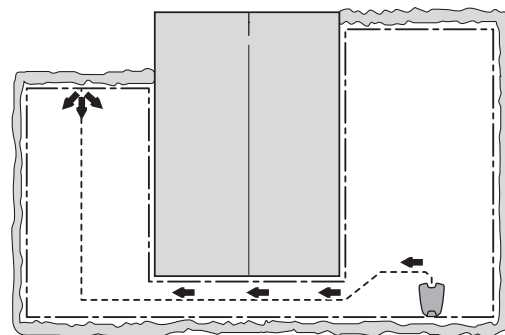

3023-025

GARDEN EXAMPLES

Area	800 m ² . Unsymmetrical working area with a narrow passage and a number of islands.
Timer	<p>Automower® 310 07:00-24:00 Monday to Saturday</p> <p>Automower® 315 08:00-22:00 Monday to Saturday</p>
Lawn coverage	Factory setting
Find charging station	Factory setting
Remarks	The guide wire must be placed along the narrow passage to ensure that the robotic lawnmower can with ease locate the charging station from the right hand side of the working area. As the right hand area is only a small part of the working area, the <i>Lawn coverage</i> factory settings can be used.
Area	800 m ² . Three areas linked with two narrow passages.
Timer	<p>Automower® 310 07:00-24:00 Monday to Saturday</p> <p>Automower® 315 08:00-22:00 Monday to Saturday</p>
Lawn coverage	<p>Area 1: <i>How? Guide</i> <i>How far? x m</i> <i>How often? 25%</i></p> <p>Area 2: <i>How? Guide</i> <i>How far? x m</i> <i>How often? 25%</i></p>
Find charging station	Factory setting
Remarks	As the working area contains several areas linked by narrow passages, <i>Lawn coverage</i> must be used to create several areas to obtain an even mowing result across the entire working area.

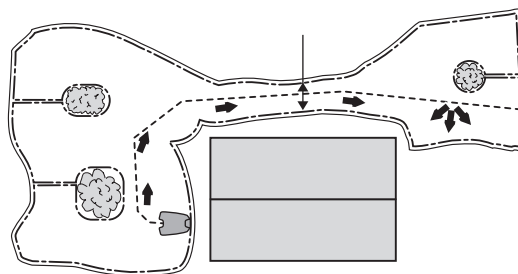

3023-026

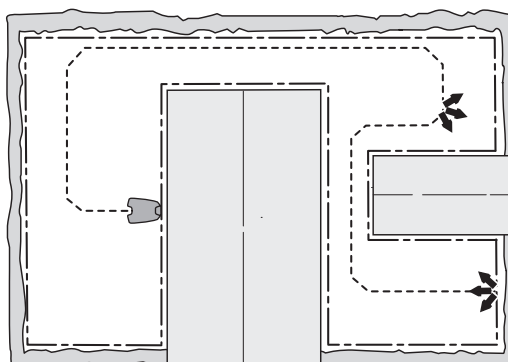

3023-027



GARDEN EXAMPLES

Area	500 m ² + 100 m ² in a secondary area.
Timer	Automower® 310 08:00-20:30 Monday, Tuesday, Thursday, Friday, Saturday Automower® 315 08:00-18:30 Monday, Tuesday, Thursday, Friday, Saturday
Lawn coverage	Factory setting
Find charging station	Factory setting
Remarks	The secondary area is cut using the <i>Secondary area</i> mode on Wednesday and Sunday. As the area is open and uncomplicated there is no need for a guide wire in this installation.

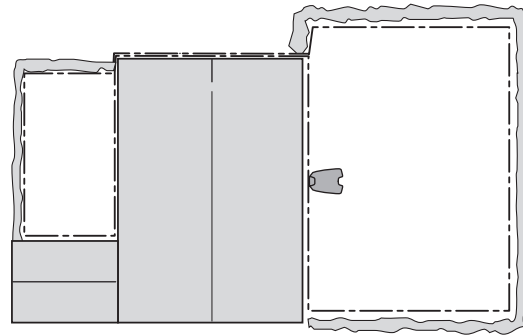

3023-033



8 Maintenance

For better operating reliability and longer service life: check and clean the robotic lawnmower regularly and replace worn parts if necessary. See 8.4 *Cleaning on page 71* for more details on cleaning.

When the robotic lawnmower is first used, the blade disc and blades should be inspected once a week. If the amount of wear during this period has been low, the inspection interval can be increased.

It is important that the blade disc rotates easily. The edges of the blades should not be damaged. The lifetime of the blades varies immensely and depends for instance on:

- Operating time and size of the working area.
- Type of grass.
- Type of soil.
- The presence of objects such as cones, windfalls, toys, tools, stones, roots and the like.

The normal life is 2 to 6 weeks when used at maximum area capacity and longer for smaller areas. See 8.7 *Blades on page 73* on how to replace the blades.

IMPORTANT INFORMATION

Working with blunt blades gives a poorer mowing result. The grass is not cut cleanly and more energy is needed resulting in the robotic lawnmower not mowing such a large area.

8.1 Winter storage

The robotic lawnmower

The robotic lawnmower must be cleaned carefully before putting it away for the winter. See 8.4 *Cleaning on page 71*.

To guarantee battery functionality and service life, it is very important to fully charge the robotic lawnmower before storing it away for the winter. Place the robotic lawnmower in the charging station with the hatch open until the battery icon in the display shows that the battery is fully charged. Then set the main switch to 0.

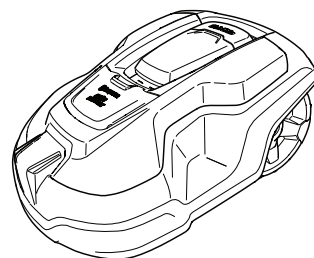

3012-1305

MAINTENANCE

IMPORTANT INFORMATION

The battery must be charged fully before winter storage. If the battery is not fully charged it can be damaged and in certain cases be rendered useless.

Check the condition of wear items such as blades and bearings in the front wheels. Rectify if necessary to make sure the robotic lawnmower is in good condition prior to next season.

Store the robotic lawnmower standing on all four wheels in a dry, frost-free environment. A wall bracket specially designed for Automower® robotic lawnmowers and charging stations is available. The wall bracket works great for winter storage. Contact your dealer for more information.

The charging station

Store the charging station and power supply indoors. The boundary loop and the guide wire can be left in the ground. The ends of the wires should be protected from damp by connecting them to an original coupler or putting them in a container with grease for instance.

If it is not possible to store the charging station indoors, the charging station must be connected to the mains, the boundary wire and the guide wires the entire winter.

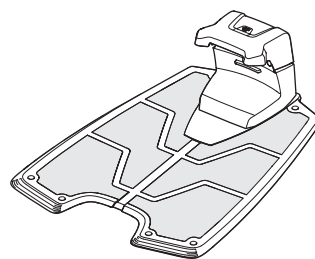

3012-1041

8.2 Winter service

Leave your robotic lawnmower with a dealer for service prior to winter storage. Regular winter service is a good way to maintain the robotic lawnmower in good condition over a long period of time and create the best conditions for a new season without any disruptions.

Service usually includes the following:

- Thorough cleaning of the body, the chassis, the blade disc and all other moving parts.
- Testing of the mower's function and components.
- Checking and if required replacement of wear items such as blades and bearings.
- Testing the mower's battery capacity as well as a recommendation to replace battery if necessary.

If necessary the dealer can also update the robotic lawnmower with new software, including new features where applicable.

MAINTENANCE

8.3 After winter storage

Check whether the robotic lawnmower, contact strips or charging strips need to be cleaned before using. If the charging or contact strips appear to be burnt or coated, clean them using fine grade emery cloth. Check that the mower's time and date are correct.

8.4 Cleaning

It is important to keep the robotic lawnmower clean. A robotic lawnmower with a lot of grass stuck to it will find it harder to travel up slopes, perform worse and be exposed to greater wear and tear. It is recommended to clean using a soft brush.

IMPORTANT INFORMATION

Never use a high-pressure washer or even running water to clean the robotic lawnmower. Never use solvents for cleaning.

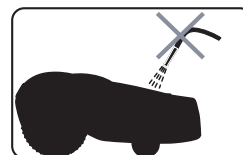

3012-271

Chassis and blade disc

1. Set the main switch to position 0.
2. Wear protective gloves.

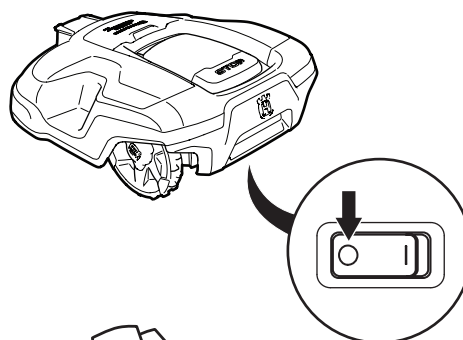

3012-1301

3012-272

3. Lift the robotic lawnmower onto its side.
4. Clean the blade disc and chassis using e.g. a dish brush.

Check at the same time that the skid plate rotates freely in relation to the blade disc.

If long blades of grass or other objects find their way in, these may impede the blade disc. Even a slight braking effect leads to a higher consumption of energy and longer mowing times, and at worst will prevent the robotic lawnmower from being able to mow a large lawn. The blade disc must be removed to carry out a more thorough cleaning. If necessary, contact your dealer.

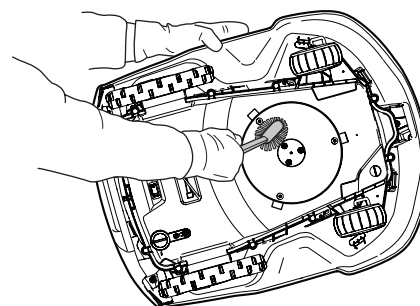

3012-1337

MAINTENANCE

Chassis

Clean the underside of the chassis. Brush or wipe with a damp cloth.

Wheels

Clean around the front wheel and rear wheels as well as the front wheel bracket.

Body

Use a damp, soft sponge or cloth to clean the body. If the body is very dirty it may be necessary to use a soap solution or washing-up liquid.

Charging station

Clean the charging station regularly from grass, leaves, twigs and other objects that may impede docking.

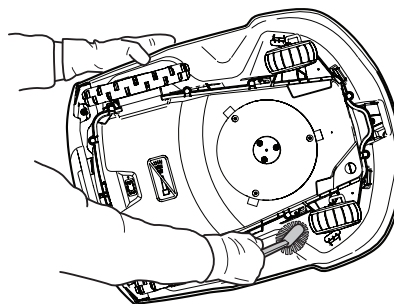

3012-1338

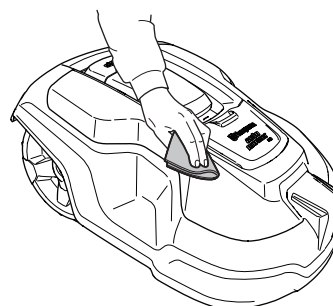

3012-1339

8.5 Transport and moving

Secure the machine during transport. It is important that the robotic lawnmower does not move when it is being transported, for instance, between lawns.

The contained lithium-ion-batteries are subject to the Dangerous Goods Legislation requirements.

For commercial transports e.g. by third parties, forwarding agents, special requirement on packaging and labeling must be observed.

For preparation of the item being shipped, consulting an expert for hazardous material is required. Please also observe possibly more detailed national regulations.

Tape or mask off open contacts and pack up the battery in such a manner that it cannot move around in the packaging.

8.6 In the event of a thunderstorm

To reduce the risk of damage to electrical components in the robotic lawnmower and its charging station, we recommend that all connections to the charging station are disconnected (power supply, boundary wire and guide wires) if there is a risk of a thunderstorm.

1. Make sure the wires are marked with the supplied markers to simplify reconnecting. The charging station's connections are marked AR, AL, G1.
2. Disconnect all wires.
3. Close the cover to the charging station to protect the connections from rain.
4. Connect all the wires if there is no longer a risk of thunder. It is important that each wire is connected to the right place.

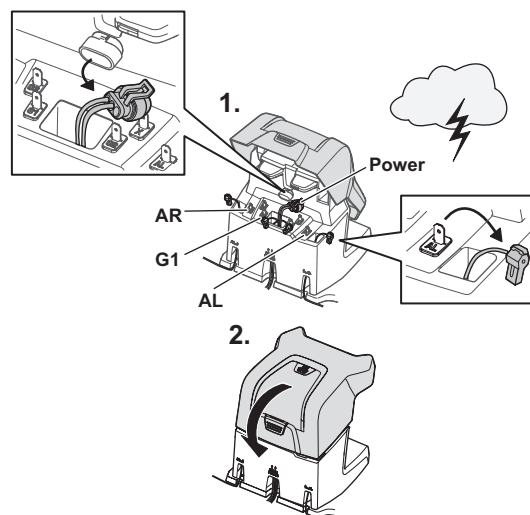

3012-1340

MAINTENANCE

8.7 Blades



WARNING

Always use original blades and screws when replacing. Only replacing the blades and reusing the screw can result in a screw wearing during mowing and shearing. The blades can then be propelled from under the body and cause serious injury.

There are three blades on the robotic lawnmower, which are screwed into the blade disc. All three blades and screws must be replaced at the same time to obtain a balanced cutting system.

Use Husqvarna genuine blades only.

To replace the blades:

1. Set the main switch to position 0.
2. Wear protective gloves.
3. Turn the robotic lawnmower upside down.
4. Rotate the skid plate so that its holes align with the screw for the blade.
5. Remove three screws. Use a straight slot or cross-tip screwdriver.
6. Remove the blade and the screw.
7. Screw on the new blade and the new screw.
Check that the blades can pivot freely.

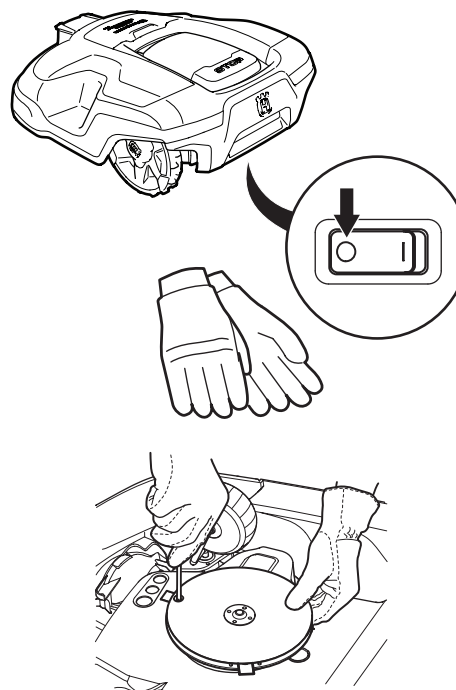

3012-1301

3012-272

3012-1207

8.8 Battery

The battery is maintenance-free, but has a limited service life of 2 to 4 years.

Battery service life is dependent on the length of the season and how many hours a day the robotic lawnmower is used. A long season or many hours of use per day means that the battery must be replaced more regularly.

Contact your dealer to replace the battery.

Only charge the battery in the included charging station. Incorrect use may result in electric shock, overheating or leaking of corrosive liquid from the battery. In the event of leakage of electrolyte flush with water/neutralizing agent, seek medical help if it comes in contact with the eyes.

IMPORTANT INFORMATION

Do not try to recharge non-rechargeable batteries.

TROUBLESHOOTING

9 Troubleshooting

In this chapter, a number of messages are listed which may be shown in the display if there is a malfunction. There is a proposal as to the cause and steps to take for each message.

This chapter also presents some symptoms that can guide you if the robotic lawnmower does not work as expected.

More suggestions for steps to take in the event of malfunction or symptoms can be found on www.automower.com.

9.1 Fault messages

A number of fault messages are listed below that can be shown on the display on the robotic lawnmower. If the same message appears often: contact your dealer.

Message	Cause	Action
<i>Wheel motor blocked, left</i>	Grass or other object has wrapped around the drive wheel.	Check the drive wheel and remove the grass or other object.
<i>Wheel motor blocked, right</i>	Grass or other object has wrapped around the drive wheel.	
<i>Cutting system blocked</i>	Grass or other object has wrapped around the blade disc.	
	The blade disc lies in a pool of water.	Move the robotic lawnmower and if possible prevent the collection of water in the working area.
<i>No loop signal</i>	The power supply is not connected.	Check the wall socket connection and whether an earth-fault breaker has tripped.
	The low voltage cable is damaged or not connected.	Check that the low voltage cable is not damaged. Check that it is also properly connected to the charging station and to the power supply.
	The boundary wire is not connected to the charging station	Check that the boundary wire connectors are fitted properly to the charging station. See 3.5 <i>Connecting the boundary wire on page 28</i> .
	Boundary wire broken.	Find out where the break is. See 9.5 <i>Finding breaks in the loop wire on page 80</i> . Replace the damaged section of the loop with a new loop wire and splice using an original coupler.
	ECO mode is activated and the robotic lawnmower has attempted to start outside the charging station.	Place the robotic lawnmower in the charging station, press the START button and close the hatch. See 6.8 <i>Settings on page 59</i> .
	The boundary wire is laid in the wrong direction around an island.	Check that the boundary wire has been laid according to the instructions. See 3 <i>Installation on page 16</i> .
	The connection between the robotic lawnmower and the charging station has been broken.	Place the robotic lawnmower in the charging station and generate a new loop signal. See 6.4 <i>Security on page 46</i> .
	Disturbances from metal objects (fences, reinforcement steel) or buried cables close by.	Try moving the boundary wire.

TROUBLESHOOTING

<i>Trapped</i>	The robotic lawnmower has got caught in something.	Free the robotic lawnmower and rectify the reason for it becoming trapped.
	The robotic lawnmower is stuck behind a number of obstacles.	Check if there are any obstacles which make it hard for the robotic lawnmower to move on from this location.
<i>Outside working area</i>	The boundary wire connections to the charging station are crossed.	Check that the boundary wire is connected correctly.
	The boundary wire is too close to the edge of the working area.	Check that the boundary wire has been laid according to the instructions. <i>See 3 Installation on page 16.</i>
	The working area slopes too much by the boundary loop.	
	The boundary wire is laid in the wrong direction around an island.	
	Disturbances from metal objects (fences, reinforcement steel) or buried cables close by.	Try moving the boundary wire.
The robotic lawnmower finds it hard to distinguish the signal from an installation close by.	Place the robotic lawnmower in the charging station and generate a new loop signal. <i>See 6.4 Security on page 46.</i>	
<i>Wrong PIN code</i>	Wrong PIN code has been entered. Five attempts are permitted, and the keypad is then blocked for five minutes.	Enter the correct PIN code. Contact the local dealer if you forget the PIN code.
<i>No drive</i>	The robotic lawnmower has got caught in something.	Free the robotic lawnmower and rectify the reason for the lack of drive. If it is due to wet grass, wait until the lawn has dried before using the robotic lawnmower.
	The working area includes a steep slope.	Maximum guaranteed slope is 40%. Steeper slopes should be isolated. <i>See 3.4 Installation of the boundary wire on page 22.</i>
	The guide wire is not laid at an angle on a slope.	If the guide wire is laid on a slope, it must be laid at an angle across the slope. <i>See 3.6 Installation of the guide wire on page 29.</i>
<i>Wheel motor overloaded, right</i>	The robotic lawnmower has got caught in something.	Free the robotic lawnmower and rectify the reason for the lack of drive. If it is due to wet grass, wait until the lawn has dried before using the robotic lawnmower.
<i>Wheel motor overloaded, left</i>		
<i>Charging station blocked</i>	The contact between the charging strips and contact strips may be poor and the robotic lawnmower has made a number of attempts to charge.	Put the robotic lawnmower in the charging station and check that the charging strips and contact strips make good contact.
	An object is obstructing the robotic lawnmower.	Remove the object.
<i>Stuck in charging station</i>	There is an object in the way of the robotic lawnmower preventing it from leaving the charging station.	

TROUBLESHOOTING

<i>Upside down</i>	The robotic lawnmower is leaning too much or has turned over.	Turn the robotic lawnmower the right way up.
<i>Needs manual charging</i>	The robotic lawnmower is set to the <i>Secondary area</i> operating mode.	Place the robotic lawnmower in the charging station. This behaviour is normal and no action is required.
<i>Next start hh:mm</i>	The timer setting prevents the robotic lawnmower from operating.	Change the timer settings. <i>See 6.3 Timer on page 44.</i>
	The robotic lawnmower is currently in standby.	The robotic lawnmower needs to be in the charging station for at least 2 hours per day (6 hours for Automower® 310). This is normal and no action is required.
	The clock on the robotic lawnmower is not correct.	Set the time. <i>See Time & date on page 61.</i>
<i>Empty battery</i>	The robotic lawnmower cannot find the charging station.	The guide wire is broken or not connected. The battery is spent. The charging station's antenna is defective.
<i>Lifted</i>	The lift sensor has been activated as the mower has become trapped.	Free the mower
<i>Collision sensor problem, front/rear</i>	Mower body can not move freely around its chassis.	Check that the mower body can move freely around its chassis. If the problem remains, please contact your dealer
<i>Wheel drive problem, right/left</i>	Grass or other object is wrapped around the drive wheel.	Clean the wheels and around the wheels.
<i>Alarm! Mower switched off</i>	The alarm was activated because the mower was switched OFF.	Adjust the mower security level in the Security menu.
<i>Alarm! Mower stopped</i>	The alarm was activated because the mower was stopped.	
<i>Alarm! Mower lifted</i>	The alarm was activated because the mower was lifted.	
<i>Alarm! Mower tilted</i>	The alarm was activated because the mower was tilted.	
<i>Electronic problem</i>	Temporary electronic or software related issue in the mower.	Restart the mower. If the problem remains, please contact your dealer.
<i>Loop sensor problem, front/rear</i>		
<i>Charging system problem</i>		
<i>Tilt sensor problem</i>		
<i>Temporary problem</i>		
<i>Temporary battery problem</i>	Temporary battery related issue in the mower.	
<i>Battery problem</i>		
<i>Charging current too high</i>	Wrong or faulty power supply unit.	Verify you are using correct power supply unit. If the problem remains, please contact your dealer.

TROUBLESHOOTING

9.2 Info messages

A number of info messages are listed below that can be shown on the display on the robotic lawnmower. It is recommended to contact your dealer if the same message appears often. Check that the installation is performed as described in the Operator's Manual. Then contact your local dealer.

Message	Cause	Action
<i>Low battery</i>	The robotic lawnmower cannot find the charging station.	Check that the charging station and the guide wire are installed in accordance with the instructions. See 3 <i>Installation on page 16</i> .
	The guide wire is broken or not connected.	Find out where the break is and rectify it.
	The battery is spent.	Contact your dealer to test or possibly replace the battery.
	The charging station's antenna is defective.	Check if the indicator lamp in the charging station flashes red. See 9.3 <i>Indicator lamp in the charging station on page 78</i> .
<i>Settings restored</i>	Confirmation that a <i>Reset all user settings</i> has been carried out.	This is normal. No action required.
<i>Guide not found</i>	The guide wire is not connected to the charging station.	Check that the guide wire's connector is tightly connected to the charging station. See 3.6 <i>Installation of the guide wire on page 29</i> .
	Break in the guide wire.	Find out where the break is. Replace the damaged section of the guide wire with a new loop wire and splice using an original coupler.
	The guide wire is not connected to the boundary loop.	Check that the guide wire is connected correctly to the boundary loop. See 3.6 <i>Installation of the guide wire on page 29</i> . Splice using an original coupler.
<i>Guide calibration failed</i>	The robotic lawnmower has failed to calibrate the guide wire.	Check that the guide wires are installed according to the instructions, See 3.6 <i>Installation of the guide wire on page 29</i>
<i>Guide calibration accomplished</i>	The robotic lawnmower has succeeded to calibrate the guide wire.	No action required.
<i>Difficult finding home</i>	The robotic lawnmower has been following the boundary wire several laps without finding the charging station.	The installation has not been done correctly. See <i>Laying the boundary wire on page 25</i> .
		Wrong corridor width setting on boundary wire. See <i>Finding the charging station on page 13</i> .
		The mower was started on a Secondary area with the Main area setting.

TROUBLESHOOTING

9.3 Indicator lamp in the charging station

For a fully functional installation, the indicator lamp in the charging station must emit a solid green light. If something else appears, follow the troubleshooting guide below.

There is more troubleshooting help on www.automower.com. If you still need help with troubleshooting, please contact the local dealer.

Light	Cause	Action
<i>Solid green light</i>	Good signals	No action required
<i>Green flashing light</i>	The signals are good and ECO mode is activated.	No action required. For more information on ECO mode, see <i>6.8 Settings on page 59</i> .
<i>Blue flashing light</i>	The boundary loop is not connected to the charging station	Check that the boundary wire connectors are fitted properly to the charging station. See <i>3.5 Connecting the boundary wire on page 28</i> .
	Break in the boundary loop	Find out where the break is. Replace the damaged section of the loop with a new loop wire and splice using an original coupler.
<i>Red flashing light</i>	Interruption in the charging station's antenna	Contact the local dealer.
<i>Solid blue light</i>	Weak signal as the boundary wire is too long. Max length is 800 metres.	No steps have to be taken if the robotic lawnmower operates as expected.
		Shorten the boundary wire by reducing the working area or replacing islands with barriers the robotic lawnmower can collide with.
<i>Solid red light</i>	Defective circuit board in the charging station	Contact the local dealer.

TROUBLESHOOTING

9.4 Symptoms

If your robotic lawnmower does not work as expected, follow the troubleshooting guide below.

There is a FAQ (Frequently Asked Questions) on www.automower.com which provides more detailed answers to a number of standard questions. If you still cannot find the reason for the fault, contact the local dealer.

Symptoms	Cause	Action
<i>The robotic lawnmower has difficulty docking with the charging station</i>	The charging station is on a slope	Place the charging station on a surface that is entirely level. <i>See 3.2 Installation of the charging station on page 17.</i>
	The boundary wire is not laid correctly by the charging station.	Check that the charging station has been installed according to the instructions. <i>See 3.2 Installation of the charging station on page 17.</i>
<i>Uneven mowing results</i>	The robotic lawnmower works too few hours per day.	Increase the working times. <i>See 6.3 Timer on page 44.</i> Not applicable for Automower® 310. The Weather timer senses that the lawn has been mowed more than it actually has. Increase the intensity level in the Weather timer. If this does not help, turn off the Weather timer.
	The shape of the working area requires manual settings to be made for the robotic lawnmower to find its way to all remote areas.	Also use <i>Lawn coverage</i> to steer the robotic lawnmower to one or more remote areas. <i>See 6.7 Installation on page 50.</i>
	Working area too large.	Try limiting the working area or extending the working time. <i>See 6.3 Timer on page 44.</i>
	Blunt blades.	Replace all the blades and screws so that the rotating parts are balanced. <i>See 8.7 Blades on page 73.</i>
	Accumulation of grass by the blade disc or around the motor shaft.	Check that the blade disc skid plate rotates easily. If not, screw off the blade disc and remove grass and foreign objects. <i>See 8.5 Transport and moving on page 72.</i>
<i>The robotic lawnmower runs at the wrong time</i>	The robotic lawnmower clock needs to be set.	Set the clock. <i>See 6.8 Settings on page 59.</i>
	The start and stop times for mowing are incorrect.	Reset the start time and stop time settings for mowing. <i>See 6.3 Timer on page 44.</i>
<i>The robotic lawnmower vibrates</i>	Damaged blades lead to imbalance in the cutting system.	Inspect the blades and screws and replace them if necessary. <i>See 8.7 Blades on page 73.</i>
	Many blades in the same position lead to imbalance in the cutting system.	Check that only one blade is fitted at each screw.
	Different versions (thickness) of Husqvarna blades are used.	Check if the blades are of different versions.

TROUBLESHOOTING

<i>The robotic lawnmower runs, but the blade disc does not rotate</i>	The robotic lawnmower follows a guide wire or boundary wire to or from the charging station.	This behaviour is normal and no action is required.
	The robotic lawnmower searches for a guide wire or boundary wire and the battery charge is very low.	This behaviour is normal and no action is required.
<i>The robotic lawnmower mows for shorter periods than usual between charges</i>	Grass or other foreign object blocks the blade disc.	Remove and clean the blade disc. See 8.4 <i>Cleaning on page 71</i> .
	The battery is spent.	Contact your local dealer.
<i>Both the mowing and charging times are shorter than usual</i>	The battery is spent.	Contact your local dealer.
<i>The robotic lawnmower often moves in circles or spirals</i>	Spiral cutting is a natural part of the robotic lawnmower's movement.	Adjust how often spiral cutting shall be performed. The function can be disabled if necessary. See 6.9 <i>Settings on page 59</i> .

9.5 Finding breaks in the loop wire

Breaks in the loop wire are usually the result of unintentional physical damage to the wire such as when gardening with a shovel. In countries with ground frost, also sharp stones that move in the ground can damage the wire. Breaks can also be due to the wire being stretched excessively during installation.

Mowing the grass too low right after the installation can damage wire insulation. Certain damage to the insulation may not cause disruptions until several weeks or months later.

A defective splicing of the loop wire can also lead to disruptions first several weeks after the splice was done. A faulty splice can, for example, be the result of the original coupler not being pressed together hard enough with a pair of pliers, or that a coupler of lower quality than the original coupler has been used. Please first check all known splices before further troubleshooting is done.



TROUBLESHOOTING

A wire break can be located by gradually halving the distance of the loop where the break may have occurred until there is only a very short section of the wire left.

The following method does not work if ECO mode is activated. Make sure first that ECO mode is turned off. See 6.8 Settings on page 59.

1. Check that the indicator lamp in the charging station flashes blue, which indicates a break in the boundary loop. See 9.3 Indicator lamp in the charging station on page 78.

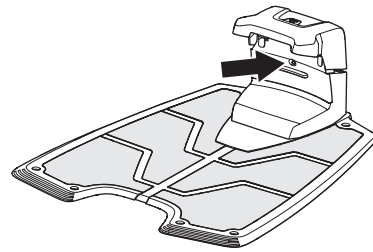

3012-1066

2. Check that the boundary wire connections to the charging station are properly connected and not damaged. Check that the indicator lamp in the charging station is still flashing blue.

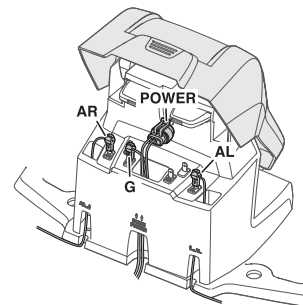

3012-1341

3. Switch the connections between the guide wire and the boundary wire in the charging station.
 - a) Switch connection AL and G1.
 If the indicator lamp is lit with a solid green light, then the break is somewhere on the boundary wire between AL and the point where the guide wire is connected to the boundary wire (thick black line in the illustration).

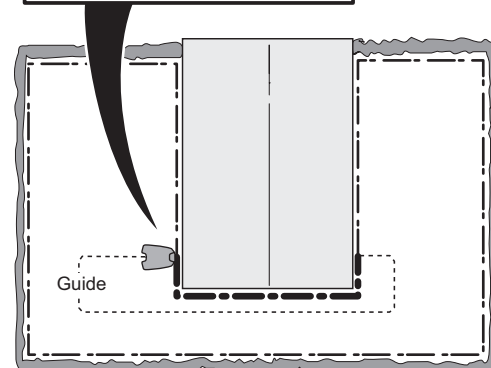
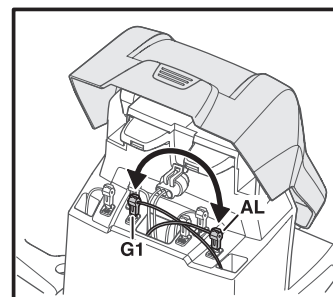

3023-043





TROUBLESHOOTING

b) Put AL and G1 back in their original positions. Then switch AR and G1. If the indicator lamp is lit with a solid green light, then the break is somewhere on the boundary wire between AR and the point where the guide wire is connected to the boundary wire (thick black line in the illustration).

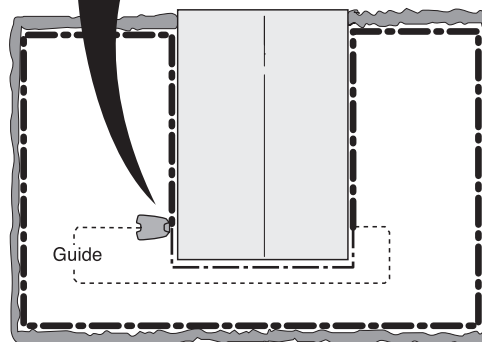
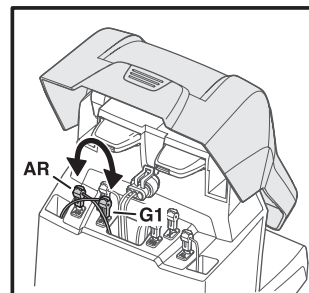

4. a) Assume that the indicator lamp is lit with a solid green light in test 3a) above. Reset all connections to their original positions. Then disconnect AR. Connect a new loop wire to AR. Connect the other end of this new loop wire somewhere at the centre of the installation.

3023-043

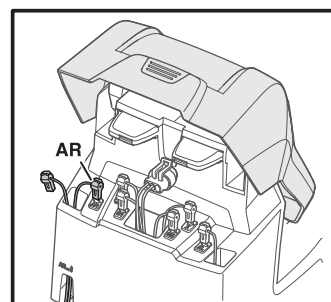

If the indicator lamp is green, then the break is somewhere in the wire between the disconnected end to the point where the new wire is connected (thick black line in the illustration).

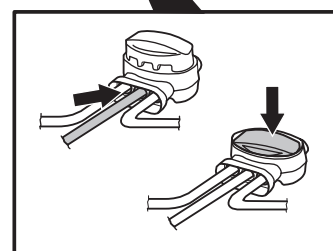
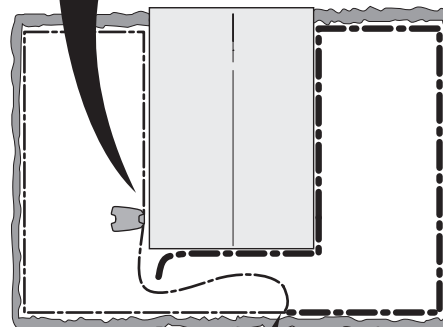

3023-044





TROUBLESHOOTING

In that case, move the connection for the new wire closer to the disconnected end (roughly at the middle of the suspected wire section) and check again if the indicator lamp is green.

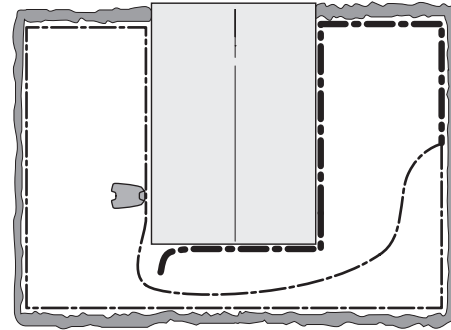

3023-029

Continue until only a very short section of the wire remains which is the difference between a flashing blue light and a solid green light.

b) If the indicator lamp is solid green in test 3b) above, a similar test is carried out but with the new loop wire connected to AL instead.

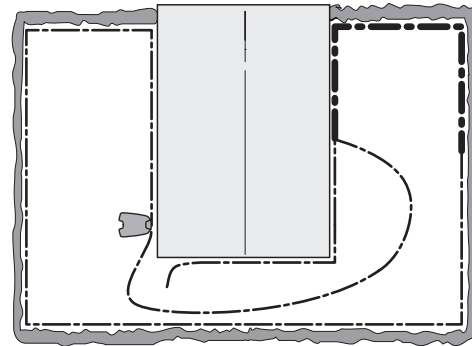

3023-030

- When the break is found, the damaged section must be replaced with a new wire. The damaged section can be cut out if it is possible to shorten the boundary wire. Always use original couplers.

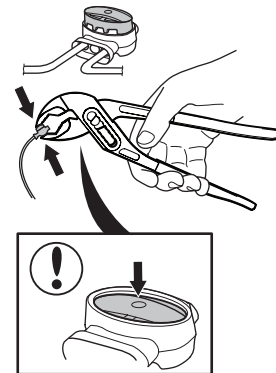

3012-1323



TECHNICAL DATA

10 Technical Data

Data	Automower® 310	Automower® 315
Dimensions		
Length	63 cm	63 cm
Width	51 cm	51 cm
Height	25 cm	25 cm
Weight	9 kg	9 kg
Electrical system		
Battery, Special Lithium-Ion battery	18 V / 2.1Ah, Art. No. 584 85 28-01	18 V / 2.1Ah, Art. No. 584 85 28-01
Power supply	100-240 V / 28 V DC	100-240 V / 28 V DC
Low voltage cable length	10 m	10 m
Mean energy consumption at maximum use	8 kWh/month for a working area of 1000 m ²	10 kWh/month for a working area of 1500 m ²
Charge current	1.3A DC	1.3A DC
Average charging time	60 minutes	60 minutes
Average cutting time	70 minutes	70 minutes
Noise emissions *)		
Measured sound power noise level **)	58 dB (A)	58 dB (A)
Guaranteed sound power noise level	60 dB (A)	60 dB (A)
Sound pressure noise level ***)	47 dB (A)	47 dB (A)
Mowing		
Cutting system	Three pivoted cutting blades	Three pivoted cutting blades
Blade motor speed	2300 rpm	2300 rpm
Power consumption during cutting	25 W +/- 20 %	25 W +/- 20 %
Cutting height	2-6 cm	2-6 cm
Cutting width	22 cm	22 cm
Narrowest possible passage	60 cm	60 cm
Maximum angle for cutting area	40 %	40 %
Maximum angle for boundary wire	15 %	15 %
Maximum length boundary wire	800 m	800 m
Maximum length guide wire	400 m	400 m
Working capacity	1000 m ² +/- 20 %	1500 m ² +/- 20 %
IP-classification		
Robotic lawnmower	IPX4	IPX4
Charging station	IPX1	IPX1
Power supply	IPX4	IPX4

*) Noise emissions in the environment measured as sound power (L_{WA}) in conformity with EC directive 2000/14/EC. The guaranteed sound power level includes variation in production as well as variation from the test code with 1-3 dB(A).

The noise emission declarations conforms to EN 50636-2-107:2015

**) uncertainties K_{WA} , 2 dB (A)

***) uncertainties K_{PA} , 2-4 dB (A)

Husqvarna AB does not guarantee full compatibility between the robotic lawnmower and other types of wireless systems such as remote controls, radio transmitters, hearing loops, underground electric animal fencing or similar.

English - 84

GUARANTEE TERMS

11 Guarantee terms

Husqvarna AB guarantees this product's functionality for a period of two years (from date of purchase). The guarantee covers serious faults relating to materials or manufacturing faults. Within the guarantee period, we will replace the product or repair it at no charge if the following terms are met:

- The robotic lawnmower and the charging station may only be used in compliance with the instructions in this Operator's Manual.
- Users or non-authorized third parties must not attempt to repair the product.

Examples of faults which are not included in the guarantee:

- Damage caused by water seepage from underneath the robotic lawnmower. This damage is normally caused by cleaning or irrigation systems or holes/hollows in the working area when pools of water are formed when it rains.
- Damage caused by lightning.
- Damage caused by improper battery storage or battery handling.
- Damage caused by using a battery that is not a Husqvarna original battery.
- Damage caused by not using Husqvarna original spare parts and accessories, such as blades and installation material.
- Damage to the loop wire.

The blades are seen as disposable and are not covered by the guarantee.

If a fault occurs with your robotic lawnmower, please contact the dealer (see Memo on page 2) for further instructions. Please have your receipt and product serial number to hand for quicker assistance.

ENVIRONMENTAL INFORMATION

12 Environmental information

The symbol on the Husqvarna robotic lawnmower or its packaging indicates that this product cannot be treated as domestic waste. It should instead be left at a suitable recycling centre to recycle its electronic components and batteries.

The batteries are encased in the chassis of the robotic lawnmower. To access the batteries, the chassis must be dismantled. Consult your dealer, or follow the below instructions for removal.

By ensuring that this product is taken care of correctly, you can help to counteract the potential negative impact on the environment and people that can otherwise result through the incorrect waste management of this product.

For more detailed information about recycling this product, contact your municipality, your domestic waste service or the shop from where you purchased the product.

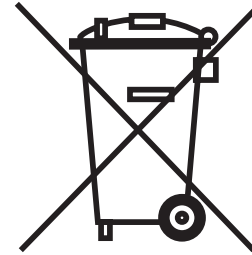

3012-689

12.1 Removing the battery for recycling

Follow these steps to remove the battery from the robotic lawnmower.

Disassembling the body

The body is fitted to the chassis using four quickmounted, snap-on brackets. The charging cable fastened to the body's charging strip must be disconnected to be able to remove the body entirely from the chassis.

1. Set the main switch to position 0.
2. Clean the area around the grommet for the charging cable found at the very front under the mower.
3. Pull out the rubber grommet on the charging cable and carefully loosen the connector.
4. Loosen the body from the chassis by lifting the body one corner at a time while holding the chassis in place.

Disassembling the chassis

1. Loosen all 14 screws (Torx 20).
2. Remove the guarantee seal at the point of separation between the chassis halves on the right-hand side.
3. Carefully lift the back edge of the upper section of the chassis.
4. Disconnect the MMI cable from the main circuit board and remove the upper section of the chassis.



ENVIRONMENTAL INFORMATION

Removing the battery

1. Disassemble the body.
2. Disassemble the chassis.
3. Loosen the screws (Torx 20) holding the battery cover in place.
4. Disconnect the battery connection from the main circuit board.
5. Open the battery cover and remove the battery.



EC DECLARATION OF CONFORMITY

13 EC Declaration of Conformity

EC declaration of conformity (Only applicable to European versions)

Husqvarna AB, SE-561 82 Huskvarna, Sweden, tel.: +46-36-146500, hereby declares under sole responsibility that the robotic lawnmowers **Husqvarna Automower® 310 and Automower® 315** with serial numbers dating 2015 week 44 and onwards (the year and week is clearly stated on the rating plate, followed by the serial number), comply with the requirements of the COUNCIL'S DIRECTIVE:

- Directive "relating to machinery" **2006/42/EC**.
 - Particular requirements for robotic battery powered electrical lawnmowers **EN 50636-2-107: 2015**
 - Electromagnetic fields **EN 62233: 2008**.
- Directive on "restriction of use of certain hazardous substances" **2011/65/EU**.
- Directive "relating to noise emissions from outdoor equipment" **2000/14/EC**.
See also the Technical Data chapter for information regarding noise emissions and the cutting width. The notified body 0404, SMP Svensk Maskinprovning AB, Box 7035, SE 750 07 Uppsala, Sweden, has issued a report regarding the assessment of conformity according to annex VI to the Council's Directive of May 8, 2000 "relating to noise emissions into the environment" 2000/14/EC. The certificate is numbered: 01/901/225.
- Directive "relating to electromagnetic compatibility" **2014/30/EU** and applicable supplements.
The following standards have been applied:
 - **EN 61000-6-3:2007/A1:2011** (emission).
 - **EN 61000-6-1:2007** (immunity).

Huskvarna, 26 October 2015



Eric Stegemyr

Vice President Electric Category

Director R&D Electric Category (acting)

(Authorized representative for Husqvarna AB and responsible for technical documentation)





Husqvarna[®]

ORIGINAL INSTRUCTIONS

AUTOMOWER is a trademark owned by Husqvarna AB. Copyright © 2016 HUSQVARNA. All rights reserved.

www.automower.com

115 78 63-26

