



Operator's manual

SILENO+ R160Li/LiC



gardena.com



Contents

1 Introduction	
1.1 Support.....	3
1.2 Product description.....	3
1.3 Product overview.....	4
1.4 Symbols on the product.....	5
1.5 Symbols on the display.....	6
1.6 Symbols on the battery.....	6
1.7 Menu structure overview 1.....	7
1.8 Menu structure overview 2.....	8
1.9 Display.....	9
1.10 Keypad.....	9
2 Safety	
2.1 Safety definitions.....	10
2.2 General safety instructions.....	10
2.3 Safety instructions for operation.....	12
3 Installation	
3.1 Introduction - Installation.....	15
3.2 Before the installation of the wires.....	15
3.3 Before the installation of the product.....	15
3.4 Installation of the product.....	19
3.5 To put the wire into position with stakes...21	
3.6 To bury the boundary wire or the guide wire.....	21
3.7 To change the position of the boundary wire or the guide wire.....	21
3.8 To extend the boundary wire or the guide wire.....	21
3.9 After the installation of the product.....	21
3.10 To do the product settings.....	22
4 Operation	
4.1 Main switch.....	28
4.2 Start.....	28
4.3 Operating mode - Start.....	28
4.4 Operating mode Park.....	29
4.5 Stop.....	29
4.6 Switch off.....	29
4.7 Timer and Standby.....	29
4.8 To charge the battery.....	30
4.9 Adjust the cutting height.....	30
5 Maintenance	
5.1 Introduction - maintenance.....	31
5.2 Clean the product.....	31
5.3 Replace the blades.....	32
5.4 Software update.....	32
5.5 Battery.....	33
5.6 Winter service.....	33
6 Troubleshooting	
6.1 Introduction - troubleshooting.....	35
6.2 Fault messages.....	35
6.3 Information messages.....	40
6.4 Indicator lamp in the charging station.....	41
6.5 Symptoms.....	42
6.6 Find breaks in the loop wire.....	43
7 Transportation, storage and disposal	
7.1 Transportation.....	46
7.2 Storage.....	46
7.3 Disposal.....	46
8 Technical data	
8.1 Technical data.....	47
9 Warranty	
9.1 Guarantee terms.....	49
10 EC Declaration of Conformity	
10.1 EC Declaration of Conformity.....	50

1 Introduction

Serial number:
PIN code:
Product registration key:

The serial number is on the product rating plate and on the product carton.

- Use the serial number to register your product on www.gardena.com.

1.1 Support

For support about the GARDENA product, speak to your GARDENA central service.

1.2 Product description

Note: GARDENA regularly updates the appearance and function of the products. Refer to *Support on page 3*.

The product is a robotic lawn mower. The product has a battery power source and cuts the grass

automatically. Collection of grass is not necessary.

The operator selects the operation settings with the keys on the keypad. The display shows the selected and possible operation settings, and the operation mode of the product.

The boundary wire and the guide wire controls the movement of the product within the work area.

1.3 Product overview

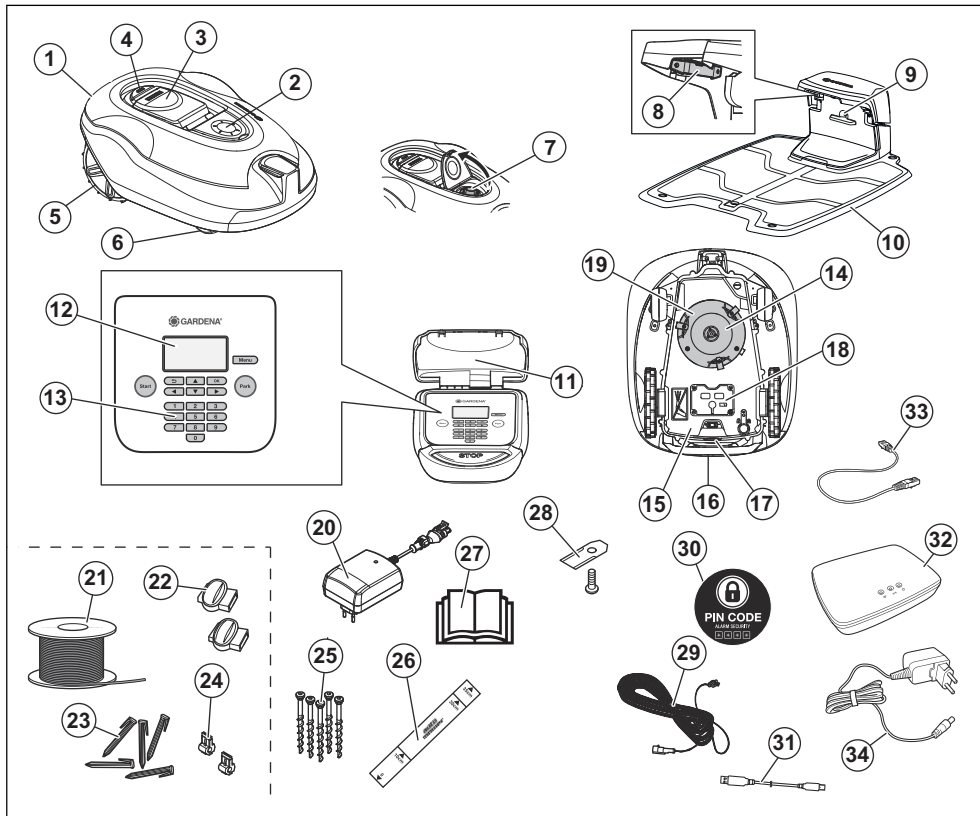

The numbers in the figure represent:

- | | |
|---------------------------------------------------------------------------------------------------------------------------------------------------------------------------------------------------------------------------------------------------------------------------------------------------------------------------------------------------------------------------------------------------------------------------------------------------------------------------|-------------------------------------------------------------------------------------------------------------------------------------------------------------------------------------------------------------------------------------------------------------------------------------------------------------------------------------------------------------------------------------------------------------------------------------------------------------------------------------------------------------------------------------------------|
| <ol style="list-style-type: none"> 1. Body 2. Hatch to cutting height adjustment 3. Hatch to display and keypad 4. Stop button 5. Rear wheels 6. Front wheels 7. Cutting height adjustment 8. Contact strips 9. LED for operation check of the charging station and boundary wire 10. Charging station 11. Rating plate 12. Display 13. Keypad | <ol style="list-style-type: none"> 14. Cutting system 15. Chassis box with electronics, battery and motors 16. Handle 17. Main switch 18. Battery cover 19. Blade disc 20. Power supply (the appearance of the power supply may differ depending on market) 21. Loop wire for boundary loop and guide wire 22. Couplers for loop wire 23. Stakes 24. Connector for the loop wire 25. Screws for securing the charging station |
|---------------------------------------------------------------------------------------------------------------------------------------------------------------------------------------------------------------------------------------------------------------------------------------------------------------------------------------------------------------------------------------------------------------------------------------------------------------------------|-------------------------------------------------------------------------------------------------------------------------------------------------------------------------------------------------------------------------------------------------------------------------------------------------------------------------------------------------------------------------------------------------------------------------------------------------------------------------------------------------------------------------------------------------|

26. Measurement gauge for help when installing the boundary wire (the measurement gauge is broken loose from the box)
27. Operator's Manual and Quick Guide
28. Extra blades
29. Low voltage cable
30. Alarm decal
31. USB cable for Software-Updates
32. smart Gateway (only for GARDENA R160LiC)
33. smart Gateway LAN-cable (only for GARDENA R160LiC)
34. smart Gateway Power Supply (only for GARDENA R160LiC)

1.4 Symbols on the product

These symbols can be found on the product. Study them carefully.



WARNING: Read the user instructions before operating the product.



WARNING: Operate the disabling device before working on or lifting the machine.

The product can only start when the main switch is set to 1 and the correct PIN code has been entered. Turn the main switch to 0 before carrying out any inspections and/or maintenance.



WARNING: Keep a safe distance from the machine when operating. Keep your hands and feet away from the rotating blades.



WARNING: Do not ride on the machine. Never put your hands or feet close to or under the machine.

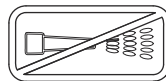

Never use a high-pressure washer or even running water to clean the product.



Lock function

CE This product conforms to the applicable EC Directives.



Noise emission to surroundings. The product's emissions are set out in *Technical data on page 47* and on the rating plate.



It is not permitted to dispose this product as normal household waste. Ensure that the product is recycled in

accordance with local legal requirements.



The chassis contains components which are sensitive to electrostatic discharge (ESD). The chassis must also be resealed in a professional manner. For these reasons the chassis shall only be opened by authorized service technicians. A broken seal can result in the entire or parts of the guarantee no longer being valid.



The low voltage cable must not be shortened, extended or spliced. Do not use a trimmer nearby the low voltage cable. Be careful when trimming edges where the cables are placed.

1.5 Symbols on the display



The timer function controls when the product cuts the lawn.



The security function lets the operator select between 3 security levels.



The SensorControl function automatically adapts the cutting intervals to the grass growth.



The installation function for manual settings for the installation.



The settings function is where the general settings for the products are set.



Only available for smart models. GARDENA smart system enables interaction between the product and other smart system sensors and devices.



The product will not cut the grass due to the timer function.



The product overrides the timer function.



The battery indicator shows the charge level of the battery. When the product charges the symbol flashes.



The product is put in the charging station but do not charge the battery.



The product is set in ECO-mode.

1.6 Symbols on the battery



Read the user instructions.



Do not discard the battery into fire and do not expose the battery to a heat source.



Do not immerse the battery into water.

1.7 Menu structure overview 1

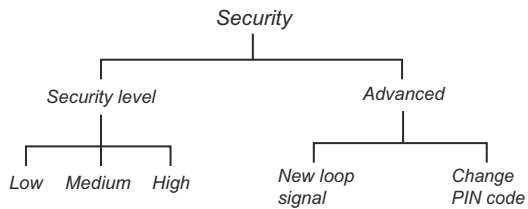
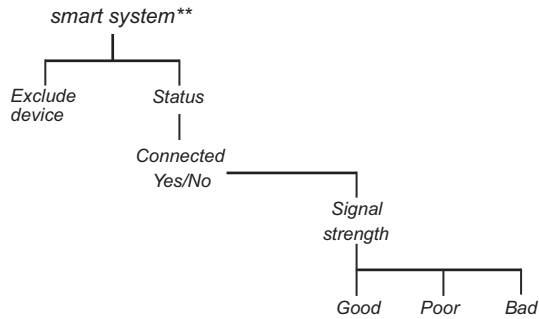
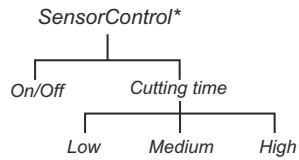
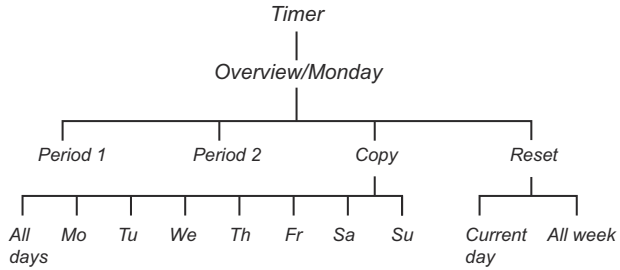

* GARDENA R160Li, R160LiC

** GARDENA R160LiC

1.8 Menu structure overview 2

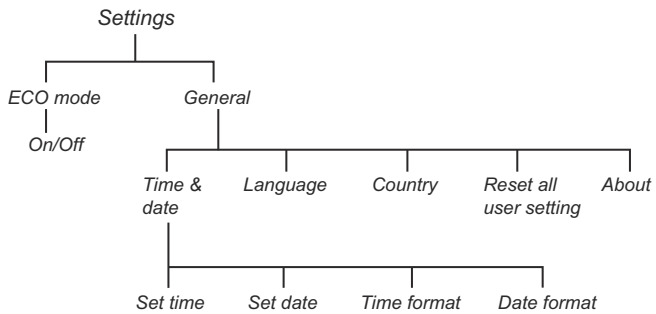
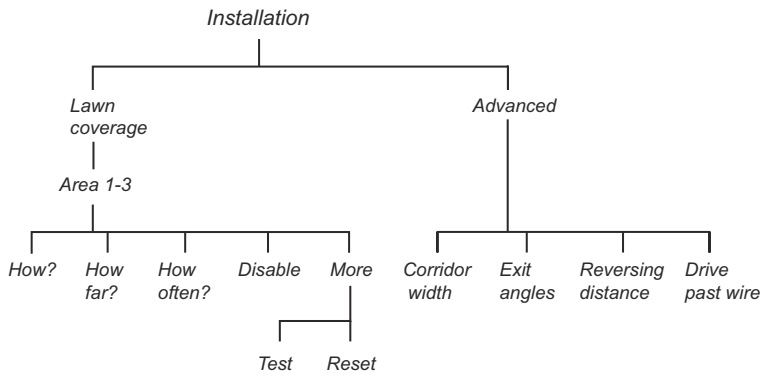

1.9 Display

The display on the product shows information and settings of the product.

To access the display, push the **STOP** button.

1.10 Keypad

The keypad on the product let the operator navigate in the menu of the product. To access the keypad, push the **STOP** button.

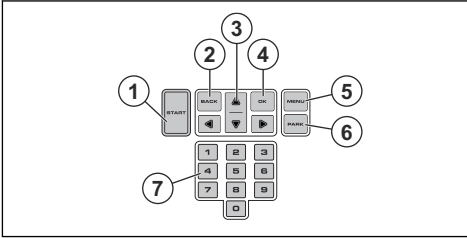

1. The **START** button is used to start the operation of the product.
2. The **BACK** button is used when moving back up in the menu lists.
3. The **arrow buttons** are used to navigate in the menu.
4. The **OK** button is used to confirm the chosen settings in the menus.
5. The **MENU** button is used to go to the main menu.
6. The **PARK** button sends the product to the charging station.
7. The **number buttons** are used to enter digits, for example, PIN code, time and date.

2 Safety

2.1 Safety definitions

Warnings, cautions and notes are used to point out specially important parts of the manual.



WARNING: Used if there is a risk of injury or death for the operator or bystanders if the instructions in the manual are not obeyed.



CAUTION: Used if there is a risk of damage to the product, other materials or the adjacent area if the instructions in the manual are not obeyed.

Note: Used to give more information that is necessary in a given situation.

2.2 General safety instructions

The following system is used in the Operator's Manual to make it easier to use:

- Text written in *italics* is a text that is shown on the display of the product or is a reference to another section in the Operator's Manual.
- Text written in **bold** is one of the buttons on the keypad of the product.
- Text written in *UPPERCASE* and *italics* refer to the different operating modes available in the product.

2.2.1 IMPORTANT. READ CAREFULLY BEFORE USE. KEEP FOR FUTURE REFERENCE

The operator is responsible for accidents or hazards occurring to other people or property.

This appliance is not intended for use by persons (including children) with reduced physical, sensory or mental capabilities (that could affect a safe handling of the product), or lack of experience and knowledge, unless they have been given supervision or instruction concerning use of the appliance by a person responsible for their safety.

This appliance can be used by children aged from 8 years and above and persons with reduced physical, sensory or mental capabilities or lack of experience and knowledge if they have been given supervision or instruction concerning use of the appliance in a safe way and understand the hazards involved. Local regulations may restrict the age of the operator. Cleaning and maintenance shall not be made by children without supervision.

Never connect the power supply to an outlet if the plug or cord is damaged. Worn or damaged cord increase the risk of electric shock.

Only charge the battery in the included charging station. Incorrect use may result in electric shock, overheating or leaking of corrosive liquid from the battery. In the event of leakage of electrolyte, flush with water/neutralizing agent. Seek medical help if it comes in contact with the eyes.

Use only original batteries recommended by the manufacturer. Product safety cannot be guaranteed with other than original batteries. Do not use non-rechargeable batteries.

The appliance must be disconnected from the supply mains when removing the battery.



WARNING: The product can be dangerous if used incorrectly.



WARNING: Do not use the product when persons, especially children, or animals, are in the work area.



WARNING: Keep your hands and feet away from the rotating blades. Never put your hands or feet close to or under the product when the motor is running.

2.3 Safety instructions for operation

2.3.1 Use

- The product may only be used with the equipment recommended by the manufacturer. All other types of use are incorrect. The manufacturer's instructions with regard to operation/maintenance must be followed precisely.
- Warning signs shall be placed around the work area of the product if it is used in public areas. The signs shall have the following text: **Warning! Automatic lawnmower! Keep away from the machine! Supervise children!**

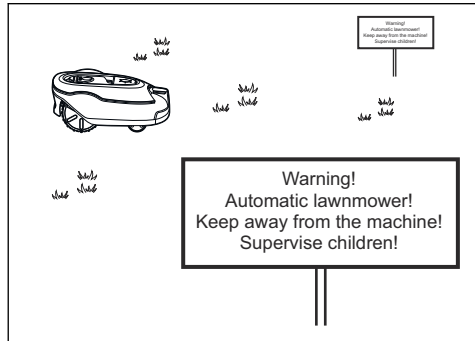

- Use the **PARK** function or switch off the main switch when persons, especially children or animals, are in the work area. It is recommended to program the product for use during hours when the area is free from activity, e.g. at night. Refer to *To set the timer on page 22*. Consider that certain species, e.g. hedgehogs, are active at night. They can potentially be harmed by the product.
- The product may only be operated, maintained and repaired by persons that are fully conversant with its special characteristics and safety regulations. Please read the Operator's Manual carefully and make sure you understand the instructions before using the product.
- It is not permitted to modify the original design of the product. All modifications are made at your own risk.
- Check that there are no stones, branches, tools, toys or other objects on the lawn that can damage the blades. Objects on the lawn can also lead to the product getting stuck. Help may be required to remove the object before the product can continue mowing. Always set the main switch in position *0* before clearing a blockage.

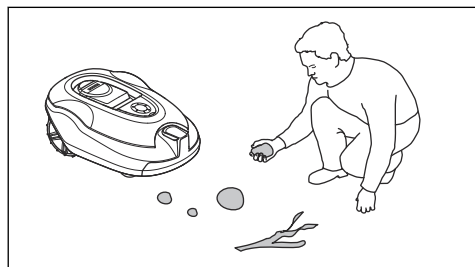

- Start the product according to the instructions. When the main switch is set to 1; make sure to keep your hands and feet away from the rotating blades. Never put your hands and feet under the product.
- Never touch moving hazardous parts, such as the blade disc, before it has come to a complete stop.
- Never lift up the product or carry it around when the main switch is in position 1.
- The product must never be allowed to collide with persons or other living creatures. If a person or other living creature comes in the way of the product, it shall be stopped immediately. Refer to *Stop on page 29*.
- Do not put anything on top of the product or its charging station.
- Do not allow the product to be used with a defective guard, blade disc or body. Neither should it be used with defective blades, screws, nuts or cables. Never connect a damaged cable, or touch a damaged cable before it is disconnected from the supply.
- Do not use the product if the main switch does not work.
- Always switch off the product using the main switch when the product is not in use. The product can only start when the main switch is set to 1 and the correct PIN code has been entered.
- The product must never be used at the same time as a sprinkler. Use the timer function (refer to *To set the timer on page 22*) so the product and sprinkler never run simultaneously.
- GARDENA does not guarantee full compatibility between the product and other types of wireless systems such as remote controls, radio transmitters, hearing loops, underground electric animal fencing or similar.
- The built-in alarm is very loud. Be careful, especially if the product is handled indoors.
- Metal objects in the ground (for example reinforced concrete or anti-mole nets) can result in a stoppage. The metal objects can cause interference with the loop signal which then can lead to a stoppage.
- Operation and storage temperature is 0-50 °C / 32-122 °F. Temperature range for charging is 0-45 °C / 32-113 °F. Too high

temperatures might cause damage to the product.

2.3.2 Battery safety



WARNING: Lithium-ion batteries can explode or cause fire if disassembled, short-circuited, exposed to water, fire, or high temperatures. Handle carefully, do not dismantle, open the battery or use any type of electrical/mechanical abuse. Avoid storage in direct sunlight.

For more information about the battery, refer to *Battery on page 33*

2.3.3 How to lift and move the product

To safely move from or within the work area:

1. Press the **STOP** button to stop the product. If security is set to the medium or high level the PIN code has to be entered. The PIN code contains four digits and is selected when you start the product for the first time. Refer to *To do the basic settings on page 22*.

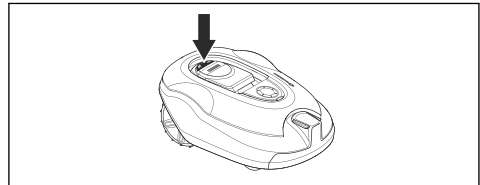

2. Set the main switch in position 0.

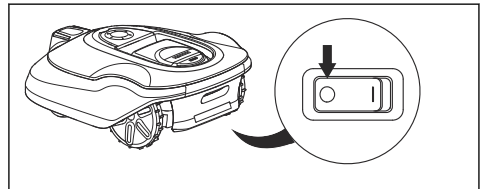

3. Carry the product by the handle under the product with the blade disc away from the body.



CAUTION: Do not lift the product when it is parked in the charging station. It can damage the charging station and/or the product. Press the **STOP** button and pull the product out of the charging station before lifting it.

2.3.4 Maintenance



WARNING: When the product is turned upside down the main switch must always be in the 0 position.

The main switch should be set in the 0 position before all work on the chassis of the product, such as cleaning or replacing the blades.

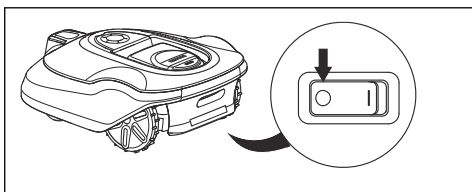

CAUTION: Never use a high-pressure washer or even running water to clean the product. Never use solvents for cleaning.



CAUTION: Use the plug to disconnect the charging station before any cleaning or maintenance of the charging station or the loop wire.

Inspect the product each week and replace any damaged or worn parts. Refer to *Introduction - maintenance on page 31*.

2.3.5 In the event of a thunderstorm

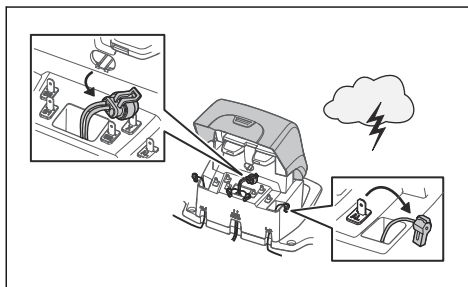

To reduce the risk of damage to electrical components in the product and the charging station, we recommend that all connections to the charging station are disconnected (power supply, boundary wire and guide wire) if there is a risk of a thunderstorm.

1. Mark the wires to simplify reconnecting. The charging station's connections are marked AR, AL and G1.
2. Disconnect all connected wires and the power supply.
3. Connect all the wires and the power supply if there is no longer a risk of thunder. It is important that each wire is connected to the right place.

3 Installation

3.1 Introduction - Installation



WARNING: Read and understand the safety chapter before you install the product.



CAUTION: Only use original spare parts and installation material.

Note: Refer to www.gardena.com for more information about installation.

3.2 Before the installation of the wires

You can select to attach the wires with stakes or bury them. You can use the 2 procedures for the same work area.

- Bury the boundary wire or the guide wire if you are going to use a dethatcher on the work area. If not, attach the boundary wire or guide wire with stakes.
- Cut the grass before you install the product. Make sure that the grass is maximum 10 cm / 4 in.

Note: The first weeks after installation the perceived sound level when cutting the grass may be higher than expected. When the product has cut the grass for some time, the perceived sound level is much lower.

3.3 Before the installation of the product

- Make a blueprint of the work area and include all obstacles.
- Make a mark on the blueprint where to put the charging station, the boundary wire and the guide wire.
- Make a mark on the blueprint where the guide wire connects to the boundary wire. Refer to *To install the guide wire on page 20*.
- Fill in holes in the lawn.

Note: Holes with water in the lawn can cause damage to the product.

3.3.1 To examine where to put the charging station

- Keep a minimum 3 m / 5 ft. of free space in front of the charging station.
- Keep a minimum of 1.5 m / 5 ft. of free space to the right and to the left of the charging station.
- Put the charging station near an outdoor power outlet.
- Put the charging station on a level surface.

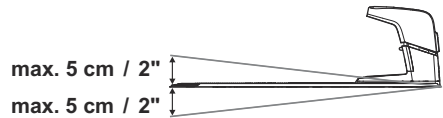

- Put the charging station in the lowest possible section of the work area.
- Put the charging station in an area without an irrigation system.
- Put the charging station in an area with protection from the sun.
- If the charging station is installed on an island, make sure to connect the guide wire to the island. Refer to *To make an island on page 17*.

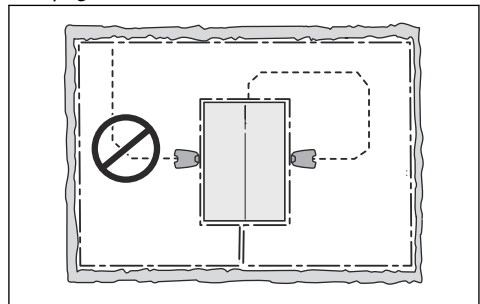

3.3.2 To examine where to put the power supply

- Put the power supply in an area with a roof and protection from the sun and rain.
- Put the power supply in an area with good airflow.
- Use a residual-current device (RCD) when you connect the power supply to the power outlet.



WARNING: Do not change the power supply. Do not cut or extend the low-voltage cable. There is a risk of electrical shock.

Low-voltage cables of different lengths are available as accessories.



CAUTION: Make sure that the blades on the product do not cut the low-voltage cable.



CAUTION: Do not put the low-voltage cable in a coil or below the charging station plate. The coil causes interference with the signal from the charging station.



3.3.3 To examine where to put the boundary wire



CAUTION: If the work area is adjacent to water bodies, slopes, precipices or a public road, the boundary wire must have a protective wall. The wall must be minimum 6 cm / 15 in. in height.

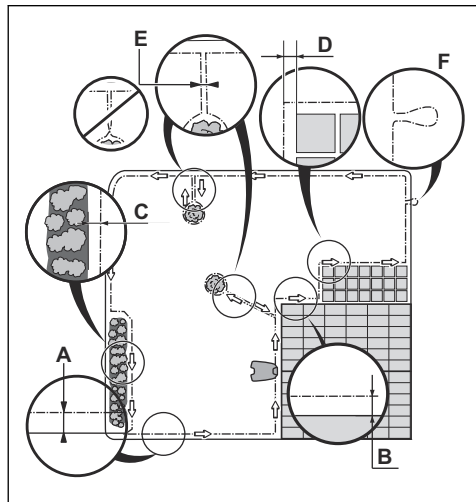

- Put the boundary wire around all of the work area (A). Adapt the distance between the boundary wire and obstacles.
- Put the boundary wire 35 cm / 14 in. (B) from an obstacle that is more than 5 cm / 2 in. high.
- Put the boundary wire 30 cm / 12 in. (C) from an obstacle that is 1.5 cm / 0.4-2 in. high.
- Put the boundary wire 10 cm / 4 in. (D) from an obstacle that is less than 1 cm / 0.4 in.
- If you have a paving stone path that is in level with the lawn, put the boundary wire below the paving stone.

Note: If the paving stone is minimum 30 cm / 12 in. wide, use the factory setting for the *Drive Past Wire* function to cut all the grass adjacent to the paving stone.



CAUTION: Do not let the product operate on gravel.

- If you make an island, put the boundary wire that runs to and from the island near together (E). Put the wires in the same stake.
- Make an eyelet (F) where the guide wire is to be connected to the boundary wire.



CAUTION: Do not make sharp bends when you install the boundary wire.



CAUTION: For careful operation without noise, isolate all obstacles such as trees, roots and stones.

3.3.3.1 To put the boundary wire in a slope

- For slopes steeper than 35% inside the work area, isolate the slope with boundary wire.
- For slopes steeper than 15% along the outer edge of the lawn, put the boundary wire 20 cm / 8 in. (A) from the edge.
- For slopes adjacent to a public road, put a fence or a protective wall along the outer edge of the slope.

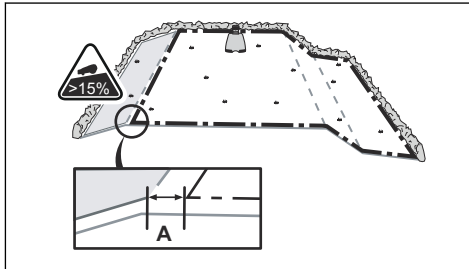

3.3.3.2 Passages

A passage is a section that has boundary wire on each side and that connects 2 work areas. The passage must be a minimum of 60 cm / 24 in. wide.

Note: If a passage is less than 2 m / 6.5 ft. wide, install a guide wire through the passage.

3.3.3.3 To make an island

- Put the boundary wire to and around the obstacle to make an island.
- Put the 2 sections of boundary wire that run to and from the obstacle together.
- Put the 2 sections of boundary wire in the same stake.

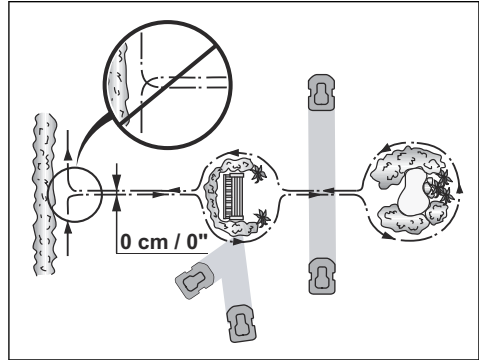

CAUTION: Do not put a section of boundary wire across the other. The sections of boundary wire must be parallel.



CAUTION: Do not put the guide wire across the boundary wire, for example a boundary wire that goes to an island.

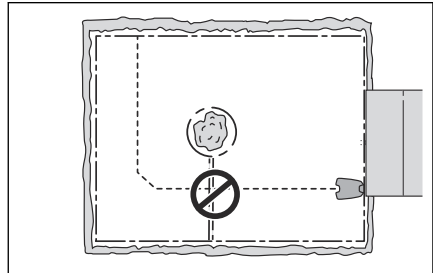

3.3.3.4 To make a secondary area

Make a secondary area if the work area has 2 areas that are not connected with a passage.

- Put the boundary wire around the secondary area (B) to make an island. The work area with the charging station is the main area (A). Refer to *To make an island on page 17*.

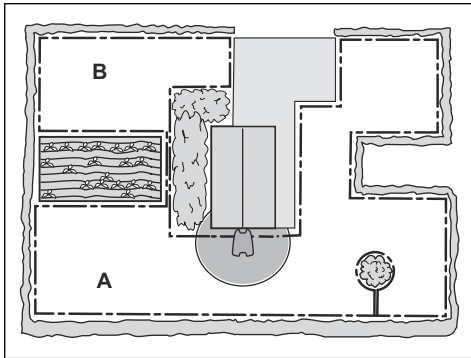

Note: When the product cuts grass in the secondary area, the *Secondary area mode* must be selected. Refer to *Secondary area on page 28*.

3.3.4 To examine where to put the guide wire

- Put the guide wire in a line at a minimum of 2 m / 7 ft. in front of the charging station.
- Make sure that the guide wire has as much free area as possible to the left of the guide wire when facing the charging station. Refer to *To set the corridor width of the guide wire on page 18*.
- Put the guide wire minimum 30 cm / 12 in. from the boundary wire.
- Do not make sharp bends when you install the guide wire.
- If the work area has a slope, put the guide wire diagonally across the slope.

3.3.4.1 To set the corridor width of the guide wire

The guide corridor is the area adjacent to the guide wire, which the product uses to find the charging station. When the product moves in the direction of the charging station, it always moves to the left of the guide wire.

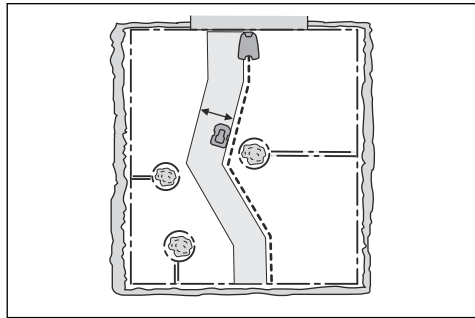

1. Do steps 1–3 in *To get access to the menu on page 22*.
2. Use the **arrow buttons** and the **OK** button to move through the menu structure *Installation > Advanced > Corridor width > Guide*.
3. Use the **number buttons** to select a corridor width of 0 to 9.
4. Push the **BACK** button.

Note: Make the corridor width as wide as possible for a minimum risk of lines in the lawn.

3.3.5 Work area examples

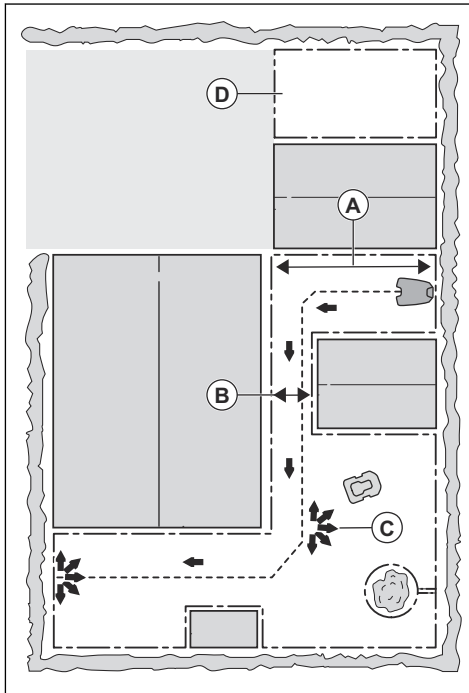

- If the charging station is put in a small area (A), make sure that the distance to the boundary wire is at a minimum 3 m / 10 ft.
- If the work area has a passage (B), make sure that the distance to the boundary wire is at a minimum 2 m / 6.5 ft. If the passage is smaller than 2 m / 6.5 ft., install a guide wire through the passage. Minimum passage between the boundary wire is 60 cm / 24 in.
- If the work area has areas which are connected by small passages (C), you can change the settings in *Lawn Coverage*. Refer to *Lawn Coverage* on page 24.
- If the work area includes a secondary area (D), refer to *To make a secondary area* on page 17. Put the product in the secondary area and select *Secondary area mode*.

3.4 Installation of the product

3.4.1 To install the charging station



WARNING: Obey national regulations about electrical safety.

1. Read and understand the instructions about the charging station. Refer to *To examine where to put the charging station* on page 15.
2. Put the charging station in the selected area.
3. Connect the low-voltage cable to the charging station.
4. Put the power supply at a minimum height of 30 cm / 12 in.

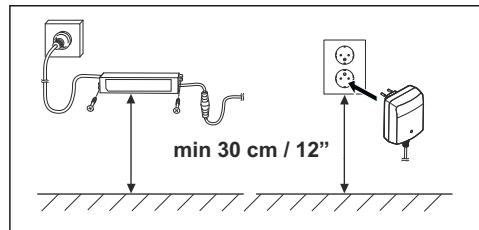

WARNING: Do not put the power supply at a height where there is a risk it can be put in water. Do not put the power supply on the ground.



WARNING: Do not encapsulate the power supply. Condensed water can harm the power supply and increase the risk of electrical shock.

5. Connect the power supply cable to a 100-240V outdoor power outlet.



WARNING: Applicable to USA/ Canada. If power supply is installed outdoors: Risk of Electric Shock. Install only to a covered Class A GFCI receptacle (RCD) that has an enclosure that is weatherproof with the attachment plug cap inserted or removed.

6. Attach the low-voltage cable in the ground with stakes or bury the cable. Refer to *To put the wire into position with stakes on page 21* or *To bury the boundary wire or the guide wire on page 21*.
7. Connect the wires to the charging station. Refer to *To install the boundary wire on page 20* and *To install the guide wire on page 20*.
8. Attach the charging station to the ground with the supplied screws.



CAUTION: Do not make new holes in the charging station plate.



CAUTION: Do not put your feet on the charging station.

3.4.2 To install the boundary wire

1. Put the boundary wire around all of the work area. Start and complete the installation behind the charging station.



CAUTION: Do not put unwanted wire in a coil. The coil causes interference with the product.

2. Open the connector and put the boundary wire in the connector.

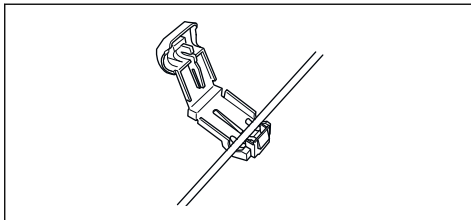

3. Close the connector with a pair of pliers.
4. Cut the boundary wire 1-2 cm / 0.4-0.8 in. above each connector.
5. Put the right end of boundary wire into the channel with the mark "AR".
6. Put the left end of boundary wire into the channel with the mark "AL".
7. Push the right connector onto the metal pin with the mark "AR".
8. Push the left connector onto the metal pin with the mark "AL".

9. Put the cable mark on the left and right boundary wire.

3.4.3 To install the guide wire

1. Open the connector and put the wire in the connector.
2. Close the connector with a pair of pliers.
3. Cut the guide wire 1-2 cm / 0.4-0.8 in. above each connector.
4. Push the guide wire through the slot in the charging station plate.
5. Push the connector onto the metal pin with the mark "GUIDE".
6. Put the cable mark on the guide wire.
7. Put the end of the guide wire at the eyelet on the boundary wire.
8. Cut the boundary wire with a pair of wire cutters.
9. Connect the guide wire to the boundary wire with a coupler.

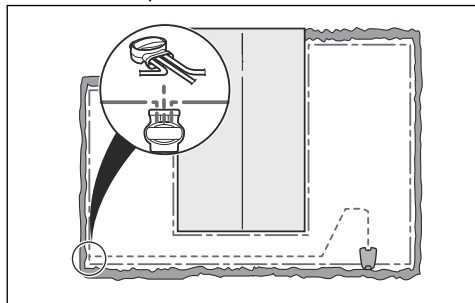

- a) Put the 2 ends of the boundary wire and the end of the guide wire into the coupler.

Note: Make sure that you can see the end of the guide wire through the transparent area of the coupler.

- b) Push the button on the coupler with an adjustable pliers.



CAUTION: Twinned cables, or a screw terminal block that is insulated with insulation tape are not satisfactory splices. Soil moisture will cause the wire to oxidize and after a time result in a broken circuit.

10. Attach the guide wire to the ground with stakes or bury the guide wire in the ground. Refer to *To put the wire into position with stakes on page 21* or *To bury the boundary wire or the guide wire on page 21*.

3.5 To put the wire into position with stakes

- Put the boundary wire and the guide wire on the ground.
- Put the stakes at a minimum of 75 cm / 30 in. distance from each other.
- Attach the stakes to the ground with a hammer or a plastic mallet.



CAUTION: Make sure that the stakes hold the boundary wire and the guide wire against the ground.

Note: The wire is overgrown with grass and not visible after a few weeks.

3.6 To bury the boundary wire or the guide wire

- Cut a groove in the ground with an edge cutter or a straight shovel.
- Put the boundary wire or the guide wire 1-20 cm / 0.4-8 in. into the ground.

3.7 To change the position of the boundary wire or the guide wire

1. If the boundary wire or the guide wire is put into position with stakes, remove the stakes from the ground.
2. Carefully remove the boundary wire or the guide wire from the ground.
3. Adjust the boundary wire or the guide wire into a new position.

4. Put the boundary wire or the guide wire into position. Refer to *To put the wire into position with stakes on page 21* or *To bury the boundary wire or the guide wire on page 21*.

3.8 To extend the boundary wire or the guide wire

Note: Extend the boundary wire or the guide wire if it is too short for the work area. Use original spare parts, for example couplers.

1. Cut the boundary wire or the guide wire with a pair of wire cutters where it is necessary to install the extension.
2. Add wire where it is necessary to install the extension.
3. Put the boundary wire or the guide wire into position.
4. Put the wire ends into a coupler.

Note: Make sure that you can see the ends of the boundary wire or the guide wire through the transparent area of the coupler.

5. Push the button on the coupler with an adjustable pliers.

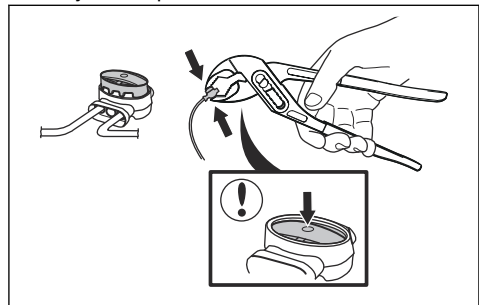

3.9 After the installation of the product

3.9.1 To do a visual check of the charging station

1. Make sure that the indicator LED lamp on the charging station has a green light.
2. If the indicator LED lamp does not have a green light, do a check of the installation. Refer to *Indicator lamp in the charging station on page 41* and *To install the charging station on page 19*.

3.9.2 To do the basic settings

Before you start the product for the first time, you must do the basic settings and calibrate the product.

1. Push the **STOP** button.
2. Set the **Main switch** to 1.
3. Push the **arrow buttons** and the **OK** button. Select *language, country, date, time* and set a PIN code.

Note: It is not possible to use 0000 as PIN code.

4. Put the product in the charging station.
5. Push the **START** button and close the hatch.

The product then moves away from the charging station and stops, while it calibrates some of the product settings.

3.10 To do the product settings

The product has factory settings but the settings can be adapted to each work area.

3.10.1 To get access to the menu

1. Push the **STOP** button.
2. Enter the PIN code on the keypad.
3. Push the **MENU** button.

3.10.2 To do the timer settings



3.10.2.1 To calculate the timer setting

1. Calculate the dimension of your lawn in m^2 / yd^2 .
2. Divide the m^2 / yd^2 of the lawn with the approximate operation capacity. Refer to table below.
3. The result is equal to the number of hours that the product must operate each day.

Note: The operation capacity is approximate and timer settings can be adjusted.

Model	Approximate operation capacity, m^2 / yd^2 / h
R160Li, R160LiC	70 / 84

Example: A lawn of $500 m^2$ / $600 yd^2$, cut with a R160Li, R160LiC.

$500 m^2 / 70 \approx 7$ h.

$600 yd^2 / 84 \approx 7$ h.

Days / week	h / day	Timer settings
7	7	08:00 - 15:00 / 7 am - 3 pm

3.10.2.2 To set the timer

1. Do steps 1–3 in *To get access to the menu on page 22*.
2. Use the **arrow buttons** and the **OK** button to move through the menu structure *Timer > Overview Timer settings*.
3. Use the **arrow buttons** and the **OK** button to select the day.
4. Use the **arrow buttons** to select the time period.
5. Push the **OK** button.
6. Enter the time with the **number buttons**. The product can cut the grass 1 or 2 periods each day.

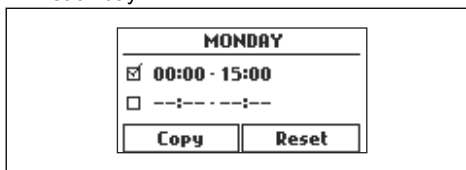

7. If the product must not cut grass on a specified day, unselect the box adjacent to the 2 time periods.

3.10.2.3 To copy the timer setting

1. Do steps 1–3 in *To get access to the menu on page 22*.
2. Use the **arrow buttons** and the **OK** button to move through the menu structure *Timer > Overview Timer settings > Overview > Copy to*.
3. Use the **arrow buttons** and the **OK** button to copy the timer setting. You can copy the timer settings day to day or for the full week.

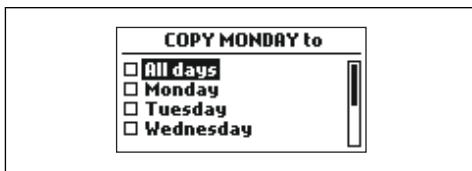

3.10.2.4 To reset the timer setting

You can remove all timer settings and use the factory setting. The factory timer setting lets the product to operate all hours of each day of the week. Refer to *Timer and Standby on page 29*.

1. Do steps 1–3 in *To get access to the menu on page 22*.
2. Use the **arrow buttons** and the **OK** button to move through the menu structure *Timer > Overview Timer settings > Overview > Reset timer*.
 - a) Push the **arrow buttons** to select *Current day* to only set the current day to factory settings.
 - b) Push the **arrow buttons** to select *All week* to reset all timer settings to factory settings.
3. Push the **OK** button.

3.10.3 Security level



There are 3 security levels for the product.

Function	Low	Medium	High
Alarm			X
PIN-code		X	X
Time lock	X	X	X

- **Alarm** - An alarm goes off if the PIN-code is not entered within 10 seconds after the **STOP** button is pushed. The alarm also goes off when the product is lifted. The alarm stops when the PIN-code is entered.
- **PIN-code** - The correct PIN-code must be entered to get access to the Menu structure of the product. If the incorrect PIN-code is entered 5 times, the product is locked for a time. The lock is extended for each new incorrect try.

- **Time lock** - The product locks if the PIN-code has not been entered in 30 days. Enter the PIN-code to get access to the product.

3.10.3.1 To set the security level

Select 1 of 3 security levels for your product.

1. Do steps 1–3 in *To get access to the menu on page 22*.
2. Use the **arrow buttons** and the **OK** button to move through the menu structure *Settings > Security > Security level*.
3. Use the **arrow buttons** and the **OK** button to select the level of security.
4. Push the **OK** button.

3.10.3.2 To change the PIN-code

1. Do steps 1–3 in *To get access to the menu on page 22*.
2. Use the **arrow buttons** and the **OK** button to move through the menu structure *Settings > Security > Advanced > Change PIN-code*.
3. Enter the new PIN code.
4. Push the **OK** button.
5. Enter the new PIN code.
6. Push the **OK** button.
7. Make a note of the new PIN code. Refer to *Introduction on page 3*.

3.10.4 SensorControl



The SensorControl automatically adjust the cutting time to the growth of the grass. The product is not permitted to operate more than the timer settings.

The first operation of the day is set by the timer settings. The product always complete 1 mowing cycle, and then the SensorControl selects if the product will continue to operate or not.

Note: The SensorControl is reset if the product does not operate for more than 50 hours, or if a reset of all user settings is done. The SensorControl is not changed if a reset of timer settings is done.

3.10.4.1 To set the SensorControl

1. Do steps 1–3 in *To get access to the menu on page 22*.
2. Use the **arrow buttons** and the **OK** button to move through the menu structure *SensorControl > Use SensorControl*.
3. Push the **OK** button to select the SensorControl.
4. Push the **BACK** button.

3.10.4.2 To set the SensorControl frequency

Set how frequently the product must cut the grass when the SensorControl is in use. There are 3 frequency levels: Low, Mid and High. The higher the frequency, the longer the product is allowed to work.

1. Do steps 1–3 in *To get access to the menu on page 22*.
2. Use the **arrow buttons** and the **OK** button to move through the menu structure *SensorControl > Cutting time*.
3. Use the **arrow buttons** to select *Low, Mid* or *High* frequency.
4. Push the **BACK** button.

3.10.5 Lawn Coverage



The Lawn Coverage function is used to guide the product to remote parts of the work area.

You can divide your lawn into 3 areas.

3.10.5.1 To set the Lawn Coverage function

1. Do steps 1–3 in *To get access to the menu on page 22*.
2. Use the **arrow buttons** and the **OK** button to move through the menu structure *Installation > Lawn Coverage > Area 1-3*
3. Use the **left arrow button** to select the area.
4. Push the **OK** button.
5. Measure the distance from the charging station to the start of the area. Measure along the guide wire. Refer to *To measure the distance from the charging station on page 24*.
6. Push the **number buttons** to select the distance, measured in m.

7. Use the **number buttons** to select the % of the cutting time the product must cut the area. The % is equal to the percentage of the area in relation to the complete work area.
 - a) Measure the area.
 - b) Divide the area with the work area.
 - c) Convert the result to %.

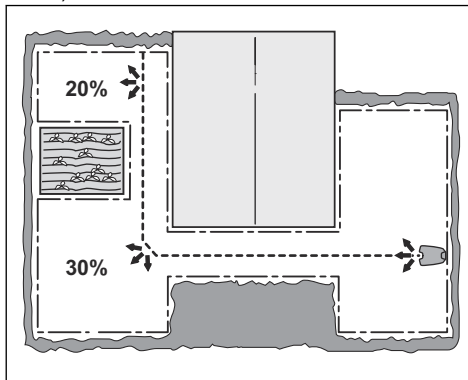

3.10.5.2 To do a test of the Lawn Coverage function

1. Put the product in the charging station.
2. Do step 1-3 in *To get access to the menu on page 22*.
3. Use the **arrow buttons** and the **OK** button to move through the menu structure *Installation > Lawn Coverage > Area 1-3 > More > Test*.
4. Push the **OK** button.
5. Push the **START** button.
6. Close the hatch.
7. Make sure the product can find the area.

3.10.5.3 To measure the distance from the charging station

1. Put the product in the charging station.
2. Do steps 1–3 in *To get access to the menu on page 22*.
3. Use the **arrow buttons** and the **OK** button to move through the menu structure *Installation > Lawn Coverage > Area 1-3 > How far?*
4. Use the **number buttons** to set 500 m as a distance.
5. Push the **BACK** button.

- Use the **arrow buttons** and the **OK** button to move through the menu structure *Installation > Lawn Coverage > Area 1-3 > More > Test*.
- Push the **OK** button.
- Push the **START** button and close the hatch.
- Push the **STOP** button when the product is at the distance you select to measure. The distance shows in the display.

3.10.5.4 To disable the Lawn Coverage function

Disable the *Lawn Coverage* function for each area.

- Do steps 1–3 in *To get access to the menu on page 22*.
- Use the **arrow buttons** and the **OK** button to move through the menu structure *Installation > Lawn Coverage > Area 1-3 > Disable*.
- Use the left **arrow button** to select *Disable*.
- Push the **OK** button.
- Push the **BACK** button.

3.10.5.5 To reset the Lawn Coverage settings

You can reset the *Lawn Coverage* settings for each area and use the factory setting.

- Do steps 1–3 in *To get access to the menu on page 22*.
- Use the **arrow buttons** and the **OK** button to move through the menu structure *Installation > Lawn Coverage > Area 1-3 > More > Reset*.
- Use the **arrow buttons** to select *Reset*.
- Push the **OK** button.

3.10.6 To set the exit angles

The product moves away from the charging station with an exit angle between 90°–270°. The exit angles can be set to 1–2 exit sectors.

- Do steps 1–3 in *To get access to the menu on page 22*.
- Use the **arrow buttons** and the **OK** button to move through the menu structure *Installation > Advanced > Exit angles > Sector 1*.
- Use the **number buttons** to set the angles in degrees.
- Push the down **arrow button**.
- Use the **number buttons** to select how frequently the product must use each sector. Set in %.

- Push the **BACK** button.

3.10.7 To set the reversing distance

The reversing distance makes the product move in reverse for a set amount of cm before the product starts to cut the lawn. The factory setting is 60 cm.

- Do steps 1-3 in *To get access to the menu on page 22*.
- Use the **arrow button** and the **OK** button to move through the menu structure *Installation > Advanced > Reversing distance*.
- Use the **number buttons** to specify the reverse distance in cm.
- Push the **BACK** button.

3.10.8 To set the Drive Past Wire function

The front of the product always moves past the boundary wire by a specified distance before the product moves back into the work area. The factory setting is 32 cm. You can select a distance of 25–40 cm.

- Do steps 1–3 in *To get access to the menu on page 22*.
- Use the **arrow button** and the **OK** button to move through the menu structure *Installation > Advanced > Drive Past Wire*.
- Use the **number buttons** to set the distance in cm.
- Push the **BACK** button.

3.10.9 Settings



In settings you can change the general settings to your product.

3.10.9.1 ECO mode

ECO mode stops the signal in the boundary loop, the guide wire and the charging station, when the product is parked or is charging.

Note: Use *ECO mode* to save energy and avoid interference with other equipment, for example hearing loops or garage doors.

Note: Push the **STOP** button before you remove the product from the charging station. If not, the product can not be started in the work area.

3.10.9.2 To set the time & date

1. Do steps 1–3 in *To get access to the menu on page 22*.
2. Use the **arrow buttons** and the **OK** button to move through the menu structure *Settings > General > Time & Date*.
3. Use the **number buttons** to set the time and then push the **BACK** button.
4. Use the **number buttons** to set the date and then push the **BACK** button.
5. Use the **arrow buttons** to set the time format and then push the **BACK** button.
6. Use the **arrow buttons** to set the date format and then push the **BACK** button.

3.10.9.3 To set the language

1. Do steps 1–3 in *To get access to the menu on page 22*.
2. Use the **arrow buttons** and the **OK** button to move through the menu structure *Settings > General > Language*.
3. Use the **arrow buttons** to select language and then push the **BACK** button.

3.10.9.4 To set the country

1. Do steps 1–3 in *To get access to the menu on page 22*.
2. Use the **arrow buttons** and the **OK** button to move through the menu structure *Settings > General > Country*.
3. Use the **arrow buttons** to select country and then push the **BACK** button.

3.10.9.5 To reset all user settings

1. Do steps 1–3 in *To get access to the menu on page 22*.
2. Use the **arrow buttons** and the **OK** button to move through the menu structure *Settings > General > Reset all user settings*.
3. Use the **right arrow button** to select *Proceed with reset of all user settings?*
4. Push the **OK** button to reset all the user settings.

Note: *Security level, PIN code, Loop signal, Messages, Date & Time, Language and Country settings* are not reset.

3.10.9.6 The About menu

The *About* menu displays information about the product, for example serial number and software versions.

3.10.10 GARDENA smart system

Only for R160LiC.

The product can connect to mobile devices that have the GARDENA smart system app installed. The GARDENA smart system makes it possible with wireless interaction between your smart product and other GARDENA smart system devices, such as smart Water Control and smart Sensor.

In this menu you can:

- Enable your smart product to include with or exclude from the GARDENA smart system app.
- Check the status of the wireless connection to the smart system.

Note: The inclusion sequence might take several minutes. Once the inclusion has succeeded you will automatically return to the product start screen. If the inclusion by any reason fails, try again.

3.10.10.1 Installation

Make sure that the smart product is fully installed before you include it into the GARDENA smart system app. Refer to *Installation on page 15*. It is important to plan the installation carefully.

3.10.10.2 Activate inclusion mode

In order to include your smart product into the GARDENA smart system app:

1. Select the smart system icon from the main menu in the product and press **OK**. The option *Activate Inclusion Mode* appears in the display.
2. Select *Yes* by pressing the right **arrow button** and then press **OK**.
3. Enter the PIN code by using the **number buttons** and press **OK**.

4. The inclusion code is presented in the product display.

Note: The product can only be shown as a device in the smart system app if it first has been included from the product.

3.10.10.3 Inclusion in the App

The inclusion of all GARDENA smart devices takes place over the smart system app.

To download the GARDENA smart system app

1. Download the GARDENA smart system app from App Store or Google Play.
2. Open the app and register as a user.
3. Log in and choose *Include device* from the start page in the app.
4. Follow the instructions in the app.

Note: The smart gateway needs internet connection to be able to include the product to the app.

3.10.10.4 Disabled menus

When the smart product is part of the smart system, some menus in the product display are disabled. You can still see all of the settings in the product but some can only be changed with the GARDENA smart system app. The following settings are blocked in the menu selection of the smart product:

- Timer
- Time & Date
- Language
- Country

3.10.10.5 Exclude device

To remove the wireless connection between the product and smart system, select the *Exclude device* option in the product menu. If you confirm to exclude the device, there will be no communication between the product and other smart system devices.

Note: The product must be manually deleted from the list of products in the GARDENA smart system app.

3.10.10.6 Status of the GARDENA smart system

Connected Yes/No

As soon as the product is connected to smart system gateway, you can check the connection status from this menu. The status is either connected *Yes* or not connected *No*.

Signal strength

The signal quality between the product and the Gateway can be either *Good*, *Poor* or *Bad*. The product charging station should preferably be placed in a location with *Signal strength - Good*, for best smart system performance.

4 Operation

4.1 Main switch



WARNING: Read the safety instructions carefully before you start the product.



WARNING: Keep your hands and feet away from the rotating blades. Never put your hands or feet close to or under the product when the motor is running.



WARNING: Do not use the product when persons, especially children, or animals, are in the work area.

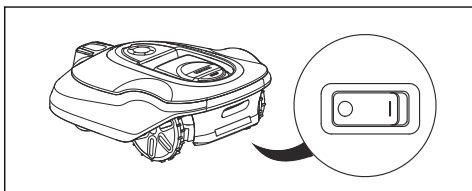

- Set the **Main switch** in the *1* position to start the product.
- Set the **Main switch** in the *0* position when the product is not in use or before any work, inspection or maintenance is being carried out.

When the **Main switch** is set in the *0* position the motors on the product cannot start.

4.2 Start

1. Press the **STOP** button to open the hatch.
2. Set the main switch to position *1*.
3. Enter the PIN code.
4. Press the **START** button.

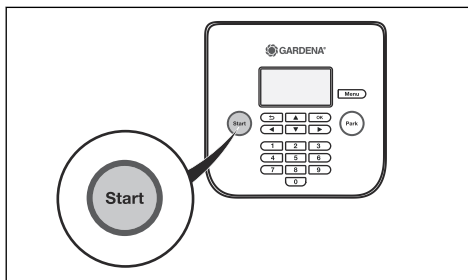

5. Select the desired operating mode. Refer to *Operating mode - Start on page 28*.

6. Close the hatch within 10 seconds.

If the product is parked in the charging station, it will only leave the charging station when the battery is fully charged and if the timer is set to allow the product to operate.

Note: Always press the **START** button before closing the hatch to start the product.

4.3 Operating mode - Start

When the **START** button has been pressed the following operation selections can be selected.

- Main area
- Secondary area
- Override timer
- Spot cutting

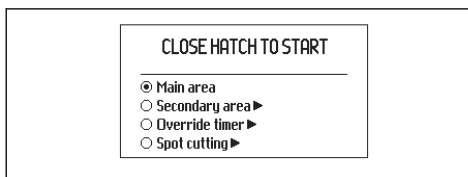

4.3.1 Main area

Main area is the standard operating mode where the product mows and charges automatically.

4.3.2 Secondary area

In the *Secondary area* mode, the product mows until the battery is empty.

If the product charges in the *Secondary area* mode, it will fully charge, drive out about 50 cm /

20 in. and then stop. This indicates that it is charged and ready to start mowing.

Note: It is recommended to change the operation selection to *Main area* before placing the product in the charging station.

4.3.3 Override timer

The timer settings can be temporarily overridden by selecting *Override timer*. It is possible to override the timer for 24 h or 3 days.

4.3.4 Spot cutting

Spot cutting is useful for quickly mowing an area where the grass has been mown less than in other parts of the garden. You must manually move the product to the chosen area.

Spot cutting means that the product mows in a spiral pattern in order to cut the grass in the area where it was started. When this is done, the product automatically switches back to *Main area* or *Secondary area*.

The *Spot cutting* function is activated with the **START** button. You can select how the product should continue to work once mowing is finished by pressing the **OK** button and then specifying *On Main area* or *On Secondary area*.

4.4 Operating mode Park

When the **PARK** button is pressed the following operation selections can be chosen.

4.4.1 Park until further notice

The product stays in the charging station until another operating mode is selected by pressing the **START** button.

4.4.2 Start on next timer

The product stays in the charging station until the next Timer setting permits operation. This operation selection is suitable if one wishes to cancel an ongoing mowing cycle and allow the product to stay in the charging station until the next day.

4.5 Stop

1. Press the **STOP** button on top of the product.

The product stops and the blade motor stops.

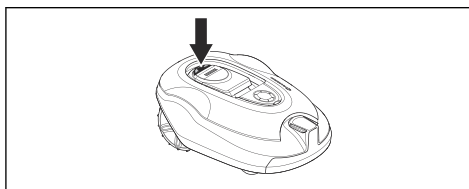

4.6 Switch off

1. Press the **STOP** button on top of the product.
2. Set the **Main switch** to position 0.

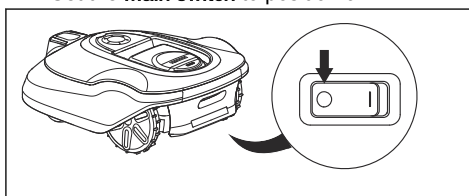

WARNING: Always switch off the product using the main switch if it requires maintenance, or if the product must be moved outside the work area.

4.7 Timer and Standby

The product has an inbuilt standby period according to the Standby time table. The standby period provides for instance a good opportunity to water or play games on the lawn.

Model	Standby time, minimum hours per day
R160Li, R160LiC	1

The factory settings for the timer allow the product to operate around the clock 7 days a week. However, the product will not operate during the built-in standby period.

4.7.1 Example 1

The times used in this example are applicable to R160Li, but the principle is the same for other models.

Timer setting, *Period 1*: 00:00-24:00

Active period (A): 00:00-23:00

The factory setting ensures that the product begins cutting the lawn at 00:00. However the product is parked in standby mode in the

charging station from 23:00 and rests until it starts cutting again at 00:00.

If the timer setting is divided into 2 work periods, the standby period can be divided into a number of periods. The minimum standby period time must however be according to the Standby time table.

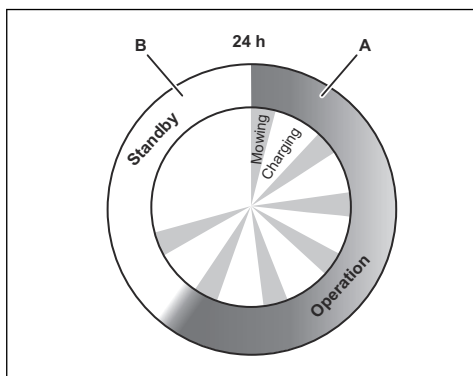

R160Li	
Operation, A = max. hours	23
Charging/Standby, B = min. hours	1

4.8 To charge the battery

When the product is new or has been stored for a long period, the battery can be dead and needs to be charged before starting. In the Main area mode, the product automatically alternates between mowing and charging.



WARNING: Only charge the product using a charging station and a power supply which is intended for it. Incorrect use may result in electric shock, overheating or leakage of corrosive liquid from the battery.

In the event of leakage of electrolyte flush with water and seek medical help if it comes in contact with the eyes etc.

1. Set the Main switch to position 1.
2. Place the product in the charging station.
3. Open the hatch and slide the product in as far as possible to ensure proper contact between the product and the charging station.

4. The display shows a message that charging is in progress.

4.9 Adjust the cutting height

The cutting height can be varied from MIN (2 cm / in.) to MAX (6 cm / in.).



CAUTION: During the first weeks after a new installation, the cutting height must be set to MAX to avoid damaging the loop wire. After this, the cutting height can be lowered step by step every week until the desired cutting height has been reached.

4.9.1 To adjust the cutting height

1. Press the **STOP** button to stop the product.
2. Open the hatch.

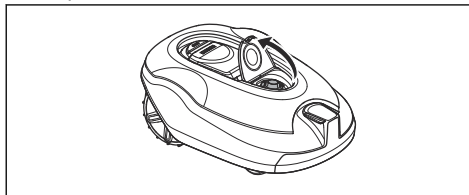

3. Turn the knob to the required position.
 - Turn clockwise to increase the cutting height.
 - Turn counter-clockwise to decrease the cutting height.
4. Close the hatch.

5 Maintenance

5.1 Introduction - maintenance

For better operating reliability and longer service life: check and clean the product regularly and replace worn parts if necessary. All maintenance and servicing must be done according to GARDENA's instructions. Refer to *Guarantee terms on page 49*.

It is important that the blade disc rotates easily. The edges of the blades should not be damaged. The lifetime of the blades varies immensely and depends for instance on:

- Operating time and size of the work area.
- Type of grass and seasonal growth.
- Soil, sand and use of fertilizers.
- The presence of objects such as, toys, tools, stones, roots and the like.

The normal life is 3 to 6 weeks when used under favorable conditions. Refer to *Replace the blades on page 32* on how to replace the blades.



WARNING: Wear protective gloves.

Note: Working with blunt blades gives a poorer mowing result. The grass is not cut cleanly and more energy is needed, resulting in the product not being able to maintain such a large area.

5.2 Clean the product

It is important to keep the product clean. A product with large amounts of grass stuck to it will not cope as well with slopes. It is recommended to clean using a brush.

GARDENA offers a special cleaning and maintenance kit as an accessory. Contact your GARDENA central service.



CAUTION: Never use a high-pressure washer to clean the product. Never use solvents for cleaning.

5.2.1 Chassis and blade disc

Inspect the blade disc and blades once a week.

1. Set the **Main switch** to position 0.

2. Lift the product onto its side.
3. Clean the blade disc and chassis using for example a dish brush. At the same time, check that the blade disc rotates freely in relation to the foot guard. Also, check that the blades are intact and can pivot freely.

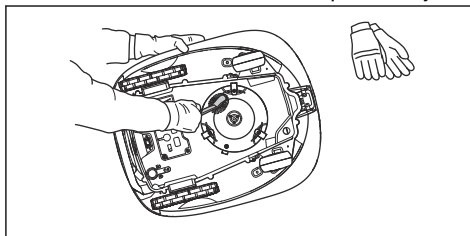

5.2.2 Chassis

Clean the underside of the chassis. Brush or wipe with a damp cloth.

5.2.3 Wheels

Clean around the front wheels and rear wheel as well as the rear wheel bracket. Grass on the wheels can impact on how the product performs in slopes.

5.2.4 Cover

Use a damp, soft sponge or cloth to clean the cover. If the cover is very dirty it may be necessary to use a soap solution or washing-up liquid.

5.2.5 Charging station

Clean the charging station regularly from grass, leaves, twigs and other objects that may impede docking.



WARNING: Use the plug to disconnect the charging station before any maintenance, or cleaning of charging station or power supply.

5.3 Replace the blades



WARNING: Use blades and screws of the right type. GARDENA can only guarantee safety when using original blades. Only replacing the blades and reusing the screw can result in a screw wearing during mowing. The blades can then be propelled from under the body and cause serious injury.

Replace worn or damaged parts for safety reasons. Even if the blades are intact, they should be replaced on a regular basis for the best mowing result and low energy usage. All 3 blades and screws must be replaced at the same time to obtain a balanced cutting system. Use GARDENA original blades embossed with the crowned H-mark logotype, refer to *Guarantee terms on page 49*.

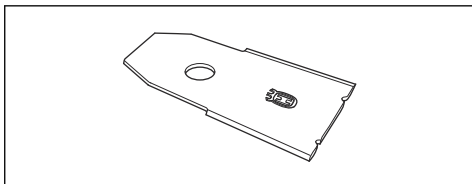

5.3.1 To replace the blades

1. Set the main switch to position 0.

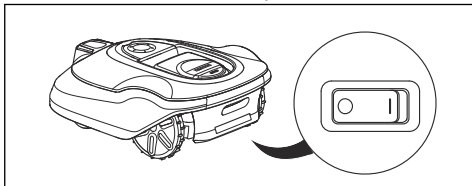

2. Turn the product upside down. Place the product on a soft and clean surface to avoid scratching the body and the hatch.
3. Remove the 3 screws. Use a straight slot or cross-tip screwdriver.

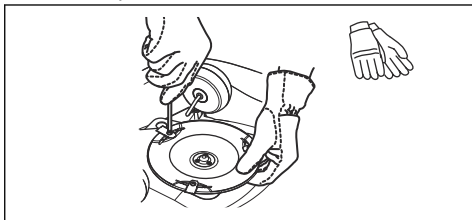

4. Remove each blade and screw.
5. Fasten new blades and screws.
6. Check that the blades can pivot freely.

5.4 Software update

If service is done by a local GARDENA representative then available software updates are downloaded to the product by the service technician. However, owners of GARDENA products can download regular software updates from the GARDENA website and install them on their product. Registered users will be notified of this by email. To download new software, the product is connected to a computer using the accompanying USB cable.

1. Connect the USB cable between your computer and the product.
 - a) Remove the service outlet plug on the bottom of the product. The service outlet is located beside the main switch.
 - b) Connect the USB cable to the computer's USB ports.
 - c) Connect the USB cable to the product service outlet. The USB cable can only be connected in one way.

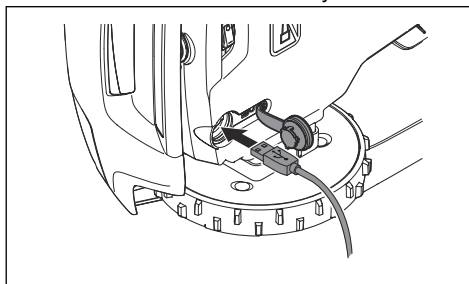

2. Set the main switch to position 1 and place the product standing on all wheels.
3. Follow the software update instructions from your received email.
4. When the product programming is completed disconnect the USB cable and fit the service outlet plug. If the seal on the service outlet plug is visibly damaged, the entire plug must be replaced. Make sure the plug is locked completely.

5.5 Battery



WARNING: Only charge the product using a charging station which is intended for it. Incorrect use may result in electric shock, overheating or leakage of corrosive liquid from the battery. In the event of leakage of electrolyte flush with water and seek medical help if it comes in contact with the eyes etc.



WARNING: Use only original batteries recommended by the manufacturer. Product safety cannot be guaranteed with other batteries. Do not use non-rechargeable batteries.



CAUTION: The battery must be charged fully before winter storage. If the battery is not fully charged it can be damaged and in certain cases be rendered useless.

If the operating times for the product are shorter than normal between charges, this indicates that the battery is getting old and eventually needs replacing. The battery is fine as long as the product maintains a well-cut lawn.

Note: Battery life is dependent on the length of the season and how many hours a day the product is operating. A long season or many hours of use a day means that the battery must be replaced more regularly.

5.5.1 To replace the battery



WARNING: Use only original batteries recommended by the manufacturer. Product safety cannot be guaranteed with other batteries. Do not use non-rechargeable batteries. The appliance must be disconnected from the supply mains when removing the battery.

1. Set the main switch to position 0.
2. Turn the product upside down. Place the product on a soft and clean surface to avoid scratching the body and the display cover.

3. Clean around the battery cover.
4. Unscrew the four screws to the battery cover (Torx 20) and remove the battery cover.

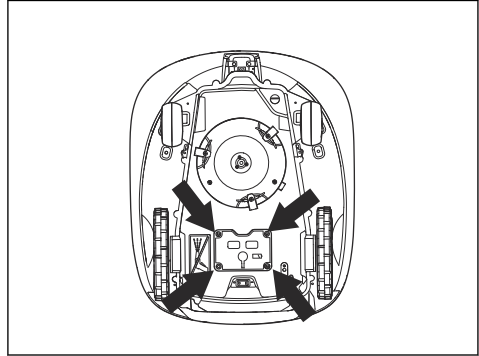

5. Carefully lift out the battery and release the connectors.



CAUTION: Do not pull the cables. Hold the connectors and release the latch.

6. Connect a new original battery by pressing the connectors together until it locks.
7. Place the battery with the sticker "This side down" downwards in the battery opening.
8. Fit the battery cover without clamping the cables. If the seal on the battery cover is visibly damaged, the entire battery cover must be replaced.
9. Carefully cross-tighten the four screws for the battery cover (Torx 20).

5.6 Winter service

Take your product to your local GARDENA representative for service prior to winter storage. Regular winter service will maintain the product in good condition and create the best conditions for a new season without any disruptions.

Service usually includes the following:

- Thorough cleaning of the body, the chassis, the blade disc and all other moving parts.
- Testing of the products's function and components.
- Checking and, if required, replacing wear items such as blades and bearings.

- Testing the products's battery capacity as well as a recommendation to replace battery if necessary.
- If new software is available, the product is updated.

6 Troubleshooting

6.1 Introduction - troubleshooting

In this chapter, a number of messages are listed which may be shown in the display if there is a malfunction. There is a proposal as to the cause and steps to take for each message. This chapter also presents some symptoms that can guide you if the product does not work as expected. More suggestions for steps to take in the event of malfunction or symptoms can be found on www.gardena.com.

6.2 Fault messages

Below a number of fault messages are listed which may be shown in the product display. Contact your local GARDENA representative if the same message appears often.

Message	Cause	Action
<i>Wheel motor blocked, left</i>	Grass or other object has wrapped around the drive wheel.	Check the drive wheel and remove the grass or other object.
<i>Wheel motor blocked, right</i>	Grass or other object has wrapped around the drive wheel.	Check the drive wheel and remove the grass or other object.
<i>Cutting system blocked</i>	Grass or other object has wrapped around the blade disc.	Check the drive wheel and remove the grass or other object.
	The blade disc lies in a pool of water.	Move the product and prevent the collection of water in the work area.
<i>No loop signal</i>	The power supply is not connected.	Check the wall socket connection and whether an earth-fault breaker has tripped or not. Check that the low voltage cable is connected to the charging station.
	The low voltage cable is damaged or not connected.	Check that the low voltage cable is not damaged. Check that it is also properly connected to the charging station and to the power supply.
	The boundary wire is not connected to the charging station.	Check that the boundary wire connectors are fitted properly to the charging station. Replace connectors if damaged. Refer to <i>To install the boundary wire on page 20</i> .
	Boundary wire broken.	Find out where the break is. Replace the damaged section of the loop with a new loop wire and splice using an original coupler. Refer to <i>Find breaks in the loop wire on page 43</i> .
	<i>ECO mode</i> is activated and the product has attempted to start outside the charging station.	Place the product in the charging station, press the START button and close the hatch. Refer to <i>ECO mode on page 25</i> .

Message	Cause	Action
<i>No loop signal</i>	The boundary wire is crossed on its way to and from an island.	Check that the boundary wire is laid according to instructions, e.g. in the right direction around the island. Refer to <i>To install the boundary wire on page 20</i> .
	The connection between the product and the charging station has been broken.	Place the product in the charging station and generate a new loop signal.
	Disturbances from metal objects (fences, reinforcement steel) or buried cables close by.	Try moving the boundary wire.
<i>Trapped</i>	The product is caught in something.	Free the product and rectify the reason for it becoming trapped.
	The product is stuck behind a number of obstacles.	Check if there are any obstacles which make it hard for the product to move away from this location.
<i>Outside work area</i>	The boundary wire connections to the charging station are crossed.	Check that the boundary wire is connected correctly.
	The boundary wire is too close to the edge of the work area.	Check that the boundary wire has been laid according to the instructions. Refer to <i>To install the boundary wire on page 20</i> .
	The work area slopes too much by the boundary loop.	
	The boundary wire is laid in the wrong direction around an island.	
	Disturbances from metal objects (fences, reinforcement steel) or buried cables close by.	Try moving the boundary wire.
	The product finds it hard to distinguish the signal from another product installation close by.	Place the product in the charging station and generate a new loop signal.
<i>Empty battery</i>	The product cannot find the charging station.	Check that the charging station and the guide wire are installed in accordance with the instructions. Refer to <i>To install the guide wire on page 20</i> .
	The guide wire is broken or not connected.	Find out where the break is and rectify it.
	The battery is spent.	Replace the battery. Refer to <i>Battery on page 33</i> .
	The charging station's antenna is defective.	Check if the indicator lamp in the charging station flashes red. Refer to <i>Indicator lamp in the charging station on page 41</i> .

Message	Cause	Action
<i>Wrong PIN code</i>	Wrong PIN code has been entered. Five attempts are permitted, and the keypad is then blocked for five minutes.	Enter the correct PIN code. Contact your local GARDENA representative if you forget the PIN code.
<i>No drive</i>	The product is caught in something.	Free the product and rectify the reason for the lack of drive. If it is due to wet grass, wait until the lawn has dried before using the product.
	The work area includes a steep slope.	Maximum guaranteed slope is 40%. Steeper slopes should be isolated. Refer to <i>To examine where to put the guide wire on page 18</i> .
	The guide wire is not laid at an angle on a slope.	If the guide wire is laid on a slope, it must be laid at an angle across the slope. Refer to <i>To install the guide wire on page 20</i> .
<i>Wheel motor overloaded, right</i>	The product is caught in something.	Free the product and rectify the reason for the lack of drive. If it is due to wet grass, wait until the lawn has dried before using the product.
<i>Wheel motor overloaded, left</i>		
<i>Charging station blocked</i>	The contact between the charging strips and contact strips may be poor and the product has made a number of attempts to charge.	Put the product in the charging station and check that the charging strips and contact strips make good contact.
	An object is obstructing the product.	Remove the object.
	The charging station is tilted or bent.	Confirm that the charging station is placed on a fully flat and horizontal ground. The charging station must not be tilted or bent.
<i>Stuck in charging station</i>	There is an object in the way of the product preventing it from leaving the charging station.	Remove the object.
<i>Upside down</i>	The product is leaning too much or has turned over.	Turn the product the right way up.
<i>Needs manual charging</i>	The product is set to the <i>Secondary area</i> operating mode.	Place the product in the charging station. This behavior is normal and no action is required.

Message	Cause	Action
<i>Next start hh:mm</i>	The timer setting prevents the product from operating.	Change the timer settings. Refer to <i>To do the timer settings on page 22</i> .
	The rest period is in progress. The product has an inbuilt standby period according to the Standby time table.	This behavior is normal and no action is required.
	The time on the product is not correct.	Set the time. Refer to <i>To set the time & date on page 26</i> .
<i>The day's mowing is complete</i>	The rest period is in progress. The product has an inbuilt standby period according to the Standby time table.	This behavior is normal and no action is required.
<i>Lifted</i>	The lift sensor has been activated as the product has become trapped.	Free the product
<i>Collision sensor problem, front/rear</i>	The product body can not move freely around its chassis.	Check that the product body can move freely around its chassis. If the problem remains, the message requires action by authorized service technician.
<i>Wheel drive problem, right/left</i>	Grass or other object is wrapped around the drive wheel.	Clean the wheels and around the wheels.
<i>Alarm! Mower switched off</i>	The alarm was activated because the product was switched OFF.	Adjust the security level in the <i>Security</i> menu, refer to <i>To set the security level on page 23</i> .
<i>Alarm! Mower stopped</i>	The alarm was activated because the product was stopped.	
<i>Alarm! Mower lifted</i>	The alarm was activated because the product was lifted.	
<i>Alarm! Mower tilted</i>	The alarm was activated because the product was tilted.	
<i>Electronic problem</i>	Temporary electronic or software related issue.	Restart the product.
<i>Loop sensor problem, front/rear</i>		If the problem remains, the message requires action by authorized service technician.
<i>Charging system problem</i>		
<i>Tilt sensor problem</i>		
<i>Temporary problem</i>		

Message	Cause	Action
<i>Temporary battery problem</i>	Temporary battery or software related issue.	Restart the product. Disconnect and reconnect the battery. If the problem remains, the message requires action by authorized service technician.
<i>Battery problem</i>		
<i>Charging current too high</i>	Wrong or faulty power supply unit.	Restart the product. If the problem remains, the message requires action by authorized service technician.
<i>Connectivity problem</i>	Potential problem on the connectivity circuit board in the product.	Restart the product. If the problem remains, the message requires action by authorized service technician.
<i>Connectivity settings restored</i>	The connectivity settings was restored due to a fault.	Please check and change the settings if needed.
<i>Poor signal quality</i>	The connectivity circuit board in the product is assembled upside down, or the product itself is tilted or upside down.	Verify the product is not upside down or tilted. If not, the message requires action by authorized service technician.

6.3 Information messages

Below a number of information messages are listed which may be shown in the display of the product. Contact your local GARDENA representative if the same message appears often.

Message	Cause	Action
<i>Low battery</i>	The product cannot find the charging station.	Check that the charging station and the guide wire are installed in accordance with the instructions. Refer to <i>To install the guide wire on page 20</i> .
	The guide wire is broken or not connected.	Find out where the break is and rectify it.
	The battery is spent.	Replace the battery. Refer to <i>Battery on page 33</i> .
	The charging station's antenna is defective.	Check if the indicator lamp in the charging station flashes red. Refer to <i>Indicator lamp in the charging station on page 41</i> .
<i>Settings restored</i>	Confirmation that a <i>Reset all user settings</i> has been carried out.	This is normal. No action required.
<i>Guide not found</i>	The guide wire is not connected to the charging station.	Check that the guide wire's connector is tightly connected to the charging station. Refer to <i>To install the guide wire on page 20</i> .
	Break in the guide wire.	Find out where the break is. Replace the damaged section of the guide wire with a new loop wire and splice using an original coupler.
	The guide wire is not connected to the boundary loop.	Check that the guide wire is connected correctly to the boundary loop. Refer to <i>To install the guide wire on page 20</i> .
<i>Guide calibration failed</i>	The product has failed to calibrate the guide wire.	Check that the guide wires are installed according to the instructions. Refer to <i>To examine where to put the guide wire on page 18</i> .
<i>Guide calibration accomplished</i>	The product has succeeded to calibrate the guide wire.	No action required.
<i>Difficult finding home</i>	The product has been following the boundary wire several laps without finding the charging station.	The installation has not been done correctly. Refer to <i>To install the boundary wire on page 20</i> .
		Wrong corridor width setting on boundary wire. Refer to <i>To install the boundary wire on page 20</i> .
		The product was started on a Secondary area with the Main area setting.

Message	Cause	Action
<i>Mowing limited by SensorControl</i>	The mowing time is limited by the SensorControl function. The SensorControl automatically adapts mowing time to the lawn growth rate.	This behavior is normal and no action is required, unless the lawn looks uncut. Then increase the intensity level of the SensorControl, or temporarily switch it off.

6.4 Indicator lamp in the charging station

For a fully functional installation, the indicator lamp in the charging station must emit a solid or flashing green light. If something else appears, follow the troubleshooting guide below.

There is more help on www.gardena.com. If you still need help, please contact your local GARDENA representative.

Light	Cause	Action
<i>Solid green light</i>	Good signals	No action required
<i>Green flashing light</i>	The signals are good and <i>ECO mode</i> is activated.	No action required.
<i>Blue flashing light</i>	The boundary loop is not connected to the charging station.	Check that the boundary wire connectors are fitted properly to the charging station.
	Break in the boundary loop.	Find out where the break is. Replace the damaged section of the loop with a new loop wire, and splice using an original coupler.
<i>Red flashing light</i>	Interruption in the charging station's antenna.	Contact your local GARDENA representative.
<i>Solid red light</i>	Fault in the circuit board or incorrect power supply in the charging station. The fault should be rectified by an authorized service technician.	Contact your local GARDENA representative.

6.5 Symptoms

If the product does not work as expected, follow the symptoms guide below.

There is a FAQ (Frequently Asked Questions) on www.gardena.com which provides more detailed answers to a number of standard questions. Contact your local GARDENA representative if you still cannot find the reason for the fault.

Symptoms	Cause	Action
The product has difficulty docking.	The boundary wire is not laid in a long straight line that is far enough out from the charging station.	Check that the charging station has been installed according to the instructions. Refer to <i>To install the charging station on page 19</i>
	The guide wire is not inserted in the slot under the charging station.	It is absolutely critical for operation that the guide wire is perfectly straight and is in the correct position under the charging station. Therefore make sure that the guide wire is always in its slot in the charging station. Refer to <i>To install the guide wire on page 20</i> .
	The charging station is on a slope.	Place the charging station on a surface that is entirely level. Refer to <i>To examine where to put the charging station on page 15</i> .
The product runs at the wrong time	The product clock needs to be set.	Set the clock. Refer to <i>To set the time & date on page 26</i> .
	The start and stop times for mowing are incorrect.	Reset the start time and stop time settings for mowing. Refer to <i>To reset the timer setting on page 23</i> .
The product vibrates.	Damaged blades lead to imbalance in the cutting system.	Inspect the blades and screws and replace them if necessary. Refer to <i>To replace the blades on page 32</i> .
	Too many blades in the same position lead to imbalance in the cutting system.	Check that only one blade is fitted at each screw.
	Different versions (thickness) of GARDENA blades are used.	Check if the blades are of different versions.
The product runs, but the blade disc does not rotate.	The product searches for the charging station.	No action. The blade disc does not rotate when the product is searching for the charging station.
The product mows for shorter periods than usual between charges.	Grass or other foreign object blocks the blade disc.	Remove and clean the blade disc. Refer to <i>Clean the product on page 31</i> .
	The battery is spent.	Replace the battery. Refer to <i>Battery on page 33</i> .

Symptoms	Cause	Action
Both the mowing and charging times are shorter than usual.	The battery is spent.	Replace the battery. Refer to <i>Battery on page 33</i> .
The product is parked for hours in the charging station.	The product has an inbuilt standby period according to the Standby time table. Refer to <i>Timer and Standby on page 29</i> .	No action.
	The hatch has been closed without the START button first being pressed.	Open the hatch, press the START button and then close the hatch.
Uneven mowing results.	The product works too few hours per day.	Increase the mowing time. Refer to <i>To calculate the timer setting on page 22</i> . SensorControl senses that the lawn have been mowed more than it actually has. Increase the intensity level in the SensorControl. If this does not help, turn off the Sensor control. Refer to <i>SensorControl on page 23</i> .
	The <i>How often?</i> setting is incorrect in relation to the layout of the work area.	Check that the correct <i>How often?</i> value is selected.
	The shape of the work area requires the use of <i>Area 1-3</i> for the product to find its way to all remote areas.	Use <i>Area 1-3</i> to steer the product to a remote area. Refer to <i>Lawn Coverage on page 24</i> .
	Work area too large.	Try limiting the work area or extending the work time. Refer to <i>To do the timer settings on page 22</i> .
	Dull blades.	Replace all the blades. Refer to <i>To replace the blades on page 32</i> .
	Long grass in relation to the set cutting height.	Increase the cutting height and then successively lower.
	Accumulation of grass by the blade disc or around the motor shaft.	Check that the blade disc rotates freely and easily. If not, screw off the blade disc and remove grass and foreign objects. Refer to <i>Clean the product on page 31</i> .

6.6 Find breaks in the loop wire

Breaks in the loop wire are usually the result of unintentional physical damage to the wire such as when gardening with a shovel. In countries with ground frost, also sharp stones that move in the ground can damage the wire. Breaks can also occur due to the wire being stretched excessively during installation.

Mowing the grass too low right after the installation can damage wire insulation. Damage to the insulation may not cause disruptions until several weeks or months later. To avoid this, always select the maximum cutting height the first weeks after installation and then lower the height one step at a time every second week until the desired cutting height has been reached.

A defective splicing of the loop wire can also lead to disruptions several weeks after the splice was done. A faulty splice can, for example, be the result of the original coupler not being pressed together hard enough with a pair of pliers, or that a coupler of lower quality than the original coupler has been used. Please first check all known splices before further troubleshooting is done.

A wire break can be located by gradually halving the distance of the loop where the break may have occurred until there is only a very short section of the wire left.

The following method does not work if *ECO mode* is activated. Make sure first that *ECO mode* is turned off. Refer to *ECO mode* on page 25.

1. Check that the indicator lamp in the charging station flashes blue, which indicates a break in the boundary loop. Refer to *Indicator lamp in the charging station* on page 41.

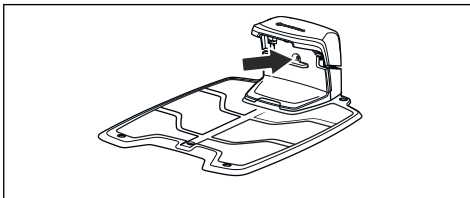

2. Check that the boundary wire connections to the charging station are properly connected and not damaged. Check that the indicator lamp in the charging station is still flashing blue.

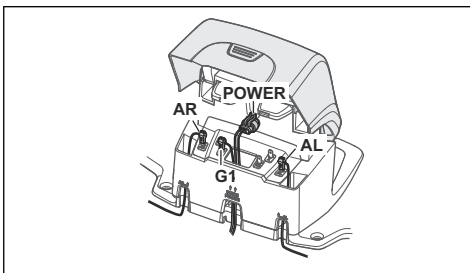

3. Switch the connections between the guide wire and the boundary wire in the charging station.

Start by switching connection AL and G1.

If the indicator lamp is lit with a solid green light, then the break is somewhere on the boundary wire between AL and the point where the guide wire is connected to the boundary wire (thick black line in the illustration).

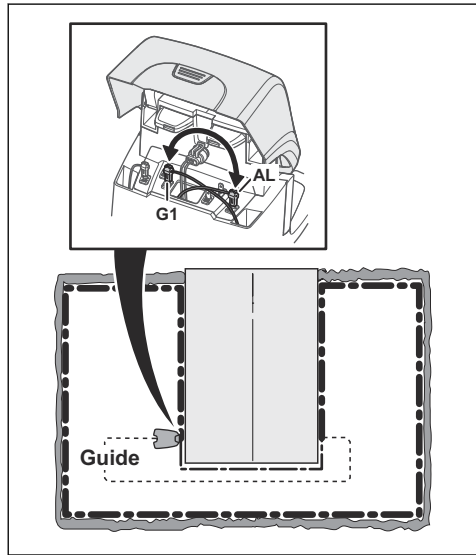

To rectify the fault you will need boundary wire, connector(s) and coupler(s):

- a) If the suspected boundary wire is short then it is easiest to exchange all of the boundary wire between AL and the point where the guide wire is connected to the boundary wire (thick black line).
- b) If the suspected boundary wire is long (thick black line) then do as follows: Put AL and G1 back to their original positions. Then disconnect AR. Connect a new loop wire to AR. Connect the other end of this new loop wire at the middle of the suspected wire section.

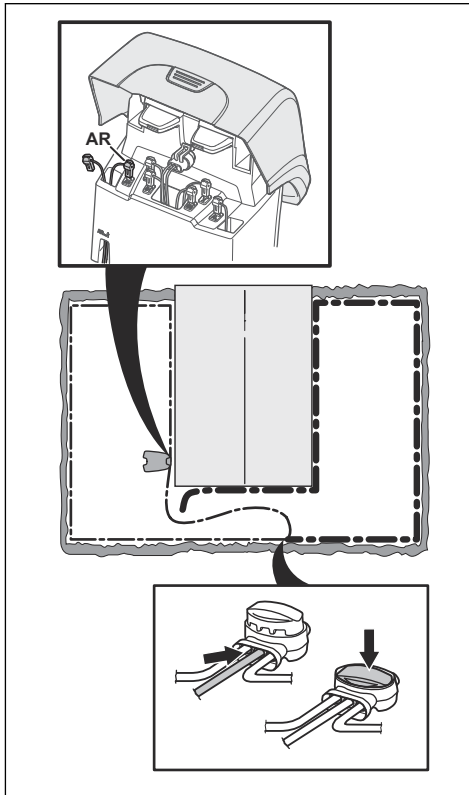

If the indicator lamp now is green, then the break is somewhere in the wire between the disconnected end to the point where the new wire is connected (thick black line below). In that case, move the connection for the new wire closer to the disconnected end (roughly at the middle of the suspected wire section) and check again if the indicator lamp is green.

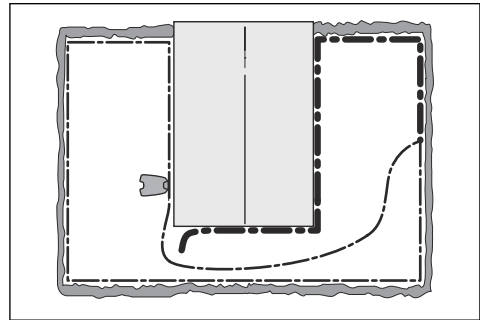

Continue until only a very short section of the wire remains which is the difference between a solid green light and a flashing blue light. Then follow instruction in step 5 below.

4. If indicator lamp still flashes blue in step 3 above: Put AL and G1 back in their original positions. Then switch AR and G1. If indicator lamp now is lit with a solid green light then disconnect AL and connect a new boundary wire to AL. Connect the other end of this new wire at the middle of the suspected wire section. Follow the same approach as in 3a) and 3b) above.
5. When the break is found, the damaged section must be replaced with a new wire. Always use original couplers.

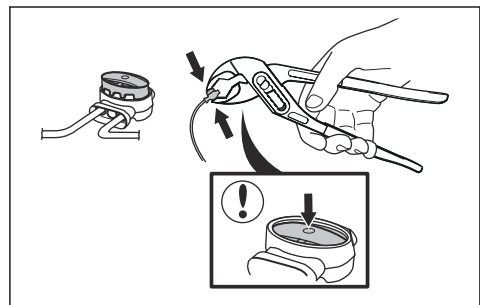

7 Transportation, storage and disposal

7.1 Transportation

The supplied Li-ion batteries obey the Dangerous Goods Legislation requirements.

- Obey all applicable national regulations.
- Obey the special requirement on package and labels for commercial transportations, including by third parties and forwarding agents.

7.2 Storage

- Fully charge the product. Refer to *To charge the battery on page 30*.
- Disconnect the product with the **main switch**. Refer to *Switch off on page 29*.
- Clean the product. Refer to *Clean the product on page 31*.
- Keep the product in a dry, frost free space.
- Keep the product with all wheels on level ground during storage, or use a GARDENA wall hanger.
- If you keep the charging station indoors, disconnect and remove the power supply and all the connectors from the charging station. Put the end of each connector wire in a container with grease.

Note: If you keep the charging station outdoors, do not disconnect the power supply and the connectors.

7.3 Disposal

- Obey the local recycling requirements and applicable regulations.
- For questions about how to remove the battery, refer to *To replace the battery on page 33*.

8 Technical data

8.1 Technical data

Data	R160Li, R160LIC
Model series	SILENO+, smart SILENO+
Dimensions	
Length, cm	63
Width, cm	51
Height, cm	25
Weight, kg	9.8
Electrical system	
Battery, Lithium-Ion 18 V/2.1 Ah Art.No	584 85 28-01, 584 85 28-02
Battery, Lithium-Ion 18 V/2.0 Ah Art.No	584 85 28-03
Battery, Lithium-Ion 18.25 V/2.0 Ah Art.No	584 85 28-04
Power supply, V/28 V DC	100-240
Low voltage cable length, m	10
Mean energy consumption at maximum use	10 kWh/month in a 1600 m ² work area
Charge current, A DC	1.3
Average mowing time, min	65
Average charging time, min	60
Operating Frequency Band, Hz	300-80000
Maximum Radio-frequency power, mW @60m ¹	<25
Noise emissions measured in the environment as sound power²	
Measured sound power noise level, dB (A)	58
Noise emissions uncertainties K _{WA} , dB (A)	2

¹ Maximum active output power to antennas in the frequency band in which the radio equipment operates.

² Noise emissions in the environment measured as sound power (L_{WA}) in conformity with EC directive 2000/14/EC. The noise emission declarations conforms to EN 50636-2-107:2015. The guaranteed sound power level includes variation in production as well as variation from the test code with 1-3 dB(A).

Data	R160Li, R160LiC
Guaranteed sound power noise level, dB (A)	60
Sound pressure noise level at the operator's ear, dB (A) ³	47
Mowing	
Cutting system	3 pivoted cutting blades
Blade motor speed, rpm	2300
Power consumption during cutting, W +/- 20 %	25
Cutting height, cm	2-6
Cutting width, cm	22
Narrowest possible passage, cm	60
Maximum angle for cutting area, %	35
Maximum angle for boundary wire, %	15
Maximum length boundary wire, m	800
Maximum length guide loop, m	400
Working capacity, m ² +/- 20%	1600
IP-classification	
Robotic lawnmower	IPX4
Charging station	IPX1
Transformer	IPX4

Internal SRD (short range device)	R160Li,	R160LiC
Operating frequency band, MHz	-	863-870
Maximum radio-frequency power, mW	-	25
Free field radio range, approx. m	-	100

Husqvarna AB does not guarantee full compatibility between the product and other types of wireless systems such as remote controls, radio transmitters, hearing loops, underground electric animal fencing or similar.

The products are made in England or the Czech Republic. See information on the rating plate. Refer to *Introduction on page 3*.

³ Sound pressure noise uncertainties K_{pA} , 2-4 dB (A)

9 Warranty

9.1 Guarantee terms

GARDENA guarantees this product's functionality for a period of two years (from date of purchase). The guarantee covers serious faults relating to materials or manufacturing faults. Within the guarantee period, we will replace the product or repair it at no charge if the following terms are met:

- The product and the charging station may only be used in compliance with the instructions in this Operator's Manual. This manufacturer's warranty does not affect warranty entitlements against the dealer/retailer.
- End-users or non-authorized third parties must not attempt to repair the product.

Examples of faults which are not included in the guarantee:

- Damage caused by water seepage from using a high-pressure washer, or from being submerged under water, for example when heavy rain forms pools of water.
- Damage caused by lightning.
- Damage caused by improper battery storage or battery handling.
- Damage caused by using a battery that is not a GARDENA original battery.
- Damage caused by not using GARDENA original spare parts and accessories, such as blades and installation material.
- Damage to the loop wire.
- Damage caused by non-authorized changing or tampering with the product or its power supply.

The blades and wheels are seen as disposable and are not covered by the guarantee.

If an error occurs with your GARDENA product, please contact GARDENA customer service for further instructions. Please have the receipt and the product's serial number at hand when contacting GARDENA customer service.

10 EC Declaration of Conformity

10.1 EC Declaration of Conformity

Husqvarna AB, SE-561 82 Huskvarna, Sweden, tel: +46-36-146500, declares that the Robotic lawnmowers, **R160Li** and **R160LiC** with serial numbers dating 2018 week 45 and onwards (the year and week is clearly stated on the rating plate, followed by the serial number), comply with the requirements of the COUNCIL'S DIRECTIVE:

- Directive "relating to machinery" **2006/42/EC**.
 - Particular requirements for robotic battery powered electrical lawnmowers **EN 50636-2-107: 2015**
 - Electromagnetic fields **EN 62233: 2008**.
- Directive on "restriction of use of certain hazardous substances" **2011/65/EU**.
 - The following standard is applied: **EN 50581:2012**
- Directive "relating to noise emissions from outdoor equipment" **2000/14/EC**. Refer to *Technical data on page 47* for information regarding noise emissions and the cutting width.

The notified body 0404, SMP Svensk Maskinprovning AB, Box 7035, SE-750 07 Uppsala, Sweden, has issued a report regarding the assessment of conformity according to annex VI to the Council's Directive of May 8, 2000 "relating to noise emissions into the environment" 2000/14/EC. The certificate is numbered: 01/901/266 for GARDENA R160Li, GARDENA R160LiC.

- Directive "relating to radio equipment" **2014/53/EU**. The following standards have been applied:
 - **ETSI EN 303 447 V1.1.1**Electromagnetic compatibility:
 - **ETSI EN 301 489-1 V2.2.0**
 - **EN 61000-6-1:2007**
 - **EN 61000-6-3:2007/A1:2011**

For R160LiC equipped with **smart system** module also:

- **EN 301 489-3 v1.6.1**
- **EN 301 489-3 v1.9.2**

- **EN 300 220-1 v2.4.1**
- **EN 300 220-2 v2.4.1**



Huskvarna 2018-11-01

Lars Roos

Global R&D Director, Robotic category

(Authorized representative for Husqvarna AB and responsible for technical documentation.)



ORIGINAL INSTRUCTIONS

We reserve the right to make changes without prior notice.
Copyright © 2019 GARDENA Manufacturing GmbH. All rights reserved.

114 07 29-26



2019-02-01

