

Flymo

Electrolux

PARTNER

Electrolux

McCULLOCH

Electrolux

HT42/420 HT45/450 HT51/510 HT60/600

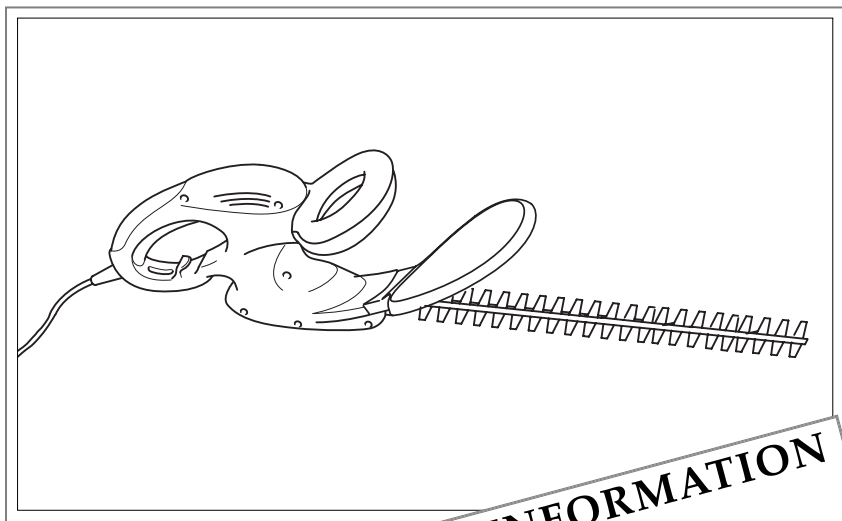

IMPORTANT INFORMATION
Read before use
& retain for future reference



For all customer enquiries or for replacement parts, contact:-

☎ 01325 300303

🖱 www.flymo.com



eop.customer.services@electrolux.co.uk

1

Carton Contents

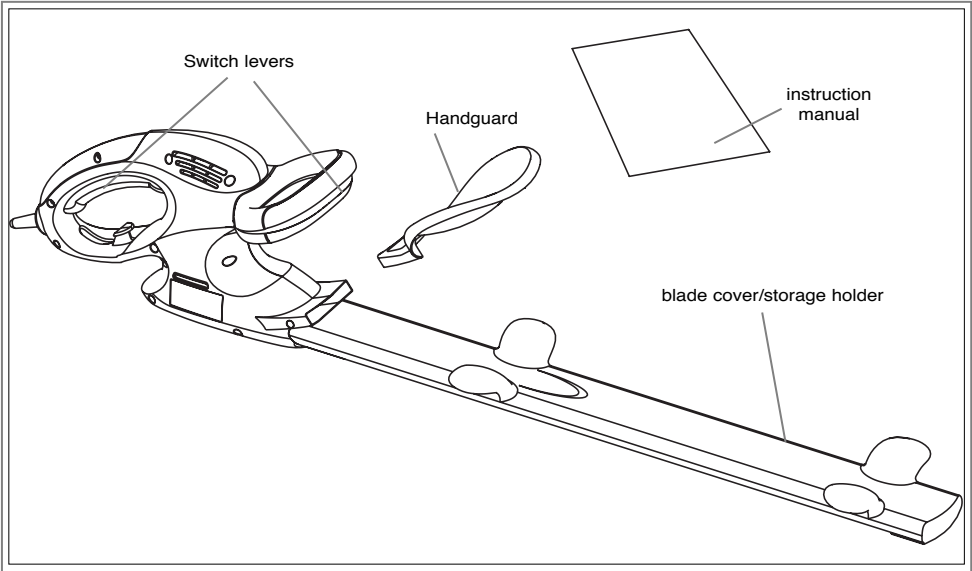

IMPORTANT !

Please check the contents of the carton are correct **BEFORE** assembling your new product.

IF ANY PARTS ARE MISSING CONTACT:-

Electrolux Outdoor Products Customer Service Department direct

Telephone : 01325 300303

Fax : 01325 318193

Safety



If not used properly this Hedgetrimmer can be dangerous! This Hedgetrimmer can cause serious injury to the operator and others, the warnings and safety instructions must be followed to ensure reasonable safety and efficiency in using this Hedgetrimmer. The operator is responsible for following the warning and safety instructions in this manual and on the Hedgetrimmer.

Explanation of Symbols on your product



Warning.



Do not use in the rain or leave the Hedgetrimmer outdoors while raining.



Read the user instructions carefully to make sure you understand all the controls and what they do.



The use of eye protection is recommended.



Switch off! Remove plug from mains before adjusting, cleaning or if cable is entangled or damaged. Keep the cable away from the blade.

General

1. Never allow children or people unfamiliar with these instructions to use the Hedgetrimmer. Local regulations may restrict the age of the operator.
2. Only use the Hedgetrimmer in the manner and for the functions described in these instructions.
3. Never operate the Hedgetrimmer when you are tired, ill or under the influence of alcohol, drugs or medicine.
4. The operator or user is responsible for accidents or hazards occurring to other people or their property.

Electrical

1. The British Standards Institute recommend the use of a Residual Current Device (R.C.D.) with a tripping current of not more than 30mA. Even with a R.C.D. installed 100% safety cannot be guaranteed and safe working practice must be followed at all times. Check your R.C.D. every time you use it.
2. Before use, examine cable for damage, replace it if there are signs of damage or ageing.
3. Do not use the Hedgetrimmer if the electric cables are damaged or worn.
4. Immediately disconnect from the mains electricity supply if the cable is cut, or the insulation is damaged. Do not touch the electric cable until the electrical supply has been disconnected. Do not repair a cut or damaged cable. Replace it with a new one.
5. Your electric cable must be uncoiled, coiled cables can overheat and reduce the efficiency of your Hedgetrimmer.
6. Keep cable away from the cutting area.
7. Never carry the product by the cable.
8. Never pull on the cable to disconnect any of the plugs
9. Do not pull cable around sharp objects.
10. Always switch off at the mains before disconnecting any plug, cable connector or extension cable.
11. Switch off, remove plug from mains and examine electric supply cable for damage or ageing **before** winding cable for storage. Do not repair a damaged cable, replace it with a new one. Use only Electrolux Outdoor Products replacement cable.
12. Always wind cable carefully, avoiding kinking.
13. Use only on AC mains supply voltage shown on the product rating label.
14. Our products are double insulated to EN60335. Under no circumstances should an earth be connected to any part of the product.

Preparation

1. Always wear suitable clothing, gloves, and stout shoes. The use of safety glasses is recommended. Do not wear loose clothing or jewellery which can be caught in moving parts.
2. Thoroughly inspect the area where the Hedgetrimmer is to be used and remove all wires and other foreign objects.
3. Before using the machine and after any impact, check for signs of wear or damage and repair as necessary.
4. Never attempt to use an incomplete Hedgetrimmer or one with an unauthorised modification.

Use

1. Use the Hedgetrimmer only in daylight or good artificial light.
2. Avoid operating your Hedgetrimmer on a wet hedge, where feasible.
3. Know how to stop the Hedgetrimmer quickly in an emergency.
4. Never hold the Hedgetrimmer by the guard.
5. Never operate the Hedgetrimmer with damaged guards or without guards in place.
6. Remove plug from mains **before** passing Hedgetrimmer to another person.
7. Avoid operating while people especially children are nearby.
8. Whilst using the Hedgetrimmer always be sure of a safe and secure operating position.
9. Keep hands and feet away from the cutting means at all times and especially when switching on the motor.
10. Do not use stepladders whilst operating the Hedgetrimmer.
11. Remove the plug from the mains :-
 - before leaving the Hedgetrimmer unattended for any period;
 - before clearing a blockage;
 - before checking, cleaning or working on the appliance;
 - if you hit an object. Do not use your Hedgetrimmer until you are sure that the entire Hedgetrimmer is in a safe operating condition;
 - if the Hedgetrimmer starts to vibrate abnormally. Check immediately. Excessive vibration can cause injury.
 - before passing to another person.

Maintenance and storage

1. Keep all nuts, bolts and screws secure to be sure the Hedgetrimmer is in safe working condition.
2. Replace worn or damaged parts for safety.
3. Be careful during adjustment of the Hedgetrimmer to prevent entrapment of the fingers between moving blades and fixed parts of the machine.
4. After use the Hedgetrimmer should be stored using the blade cover/storage holder provided.

CABLES**IMPORTANT**

- Use only 1.00mm² size cable up to 40 metres length maximum.

Maximum rating :

1.00mm² size cable, 10 amps 250 volts AC.

- **YOUR HEDGETRIMMER IS SUPPLIED WITH CABLE WIRED DIRECTLY INTO THE PRODUCT.**

1. Mains Cables and Extension Cables are available from your local Electrolux Outdoor Products Approved Service Centre.
2. Do not wire an extension cable directly to your product yourself. Please contact your local Electrolux Outdoor Products Approved Service Centre for further information on the connectors and kits available.
3. Only use extension cables specifically designed for outdoor use.

CONNECTORS**IMPORTANT**

- Connectors are suitable for use with 2 core cable only. Under no circumstances should these connectors be used for earthed products.
- All connectors and cables are of splashproof construction. They are not waterproof and must not be left outside permanently nor should they be submerged or immersed in water. Do not let cable lay or trail through pools of water or splashed with water from hose pipes.

MAINS PLUG REPLACEMENT**IMPORTANT**

- **If the plug supplied is cut off it should be destroyed. There is an electric shock hazard if a cut off plug is inserted into a 13 amp socket.**
1. **No earth required.** Our products are double insulated to EN60335 and under no circumstances should an earth be connected to any part of the product.
 2. **Ensure the mains voltage suits your product**

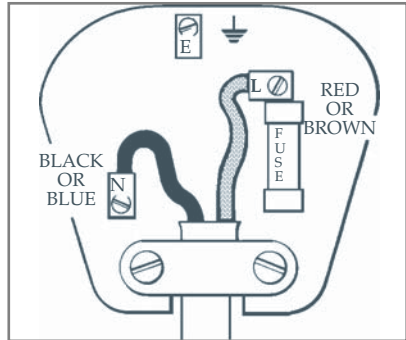
3. IMPORTANT!

The wires in the mains lead are coloured in accordance with the following code:

BLUE - NEUTRAL
BROWN - LIVE

The wire which is coloured BLUE must be connected to the Terminal which is marked with the letter 'N' or coloured BLACK.
The wire which is coloured BROWN must be connected to the Terminal which is marked with the letter 'L' or coloured RED.

4. It is important that the outer sheath is clamped correctly into the 3-pin plug.
5. If in doubt consult your local Service Repairer or qualified electrician before the machine is used.
6. **A 13 Amp fuse must be fitted to the Mains Plug.**
7. The normal plug fuse and household fuse only protect the electrical equipment and are not a safeguard against electrocution.

If your product is hard wired i.e. non-detachable mains electric cable, a conversion kit and extension cable is available from all Electrolux Outdoor Products Approved Service Centres which can be found in your local Yellow Pages.

Assembly**Assembly of Handguard.**

1. Insert Handguard into slot as illustrated in **figure A**, ensuring that it is securely located.

DO NOT USE THE PRODUCT WITHOUT FITTING THE HANDGUARD

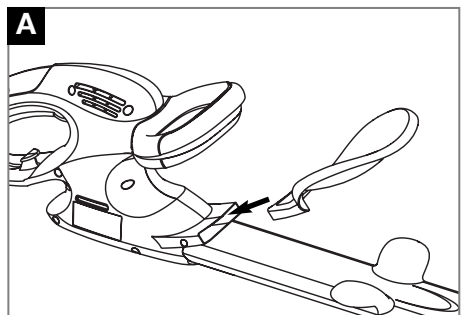

Starting and Stopping

Before starting your Hedgetrimmer.

1. Form a loop in mains cable and push the loop through the hole in the handle as illustrated in **Fig. B**.
2. To secure, position the loop over the hook and pull back as illustrated in **Fig. C**.
3. Connect to mains and switch on
4. Remove blade cover/storage holder as illustrated in **Fig. D**.

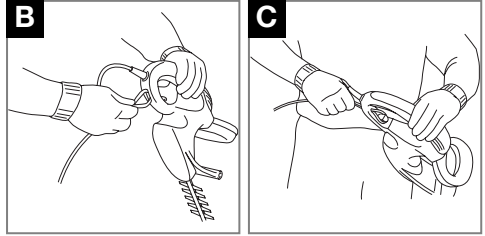

To start your Hedgetrimmer

1. There are two switch levers fitted to your Hedgetrimmer.
2. Both switch levers need to be held in the operating position (**See Fig E**) for the product to start.

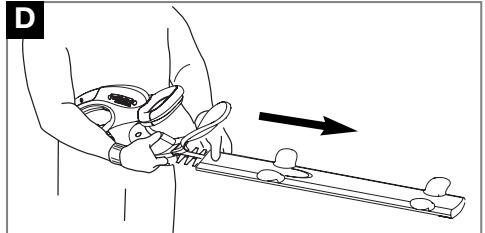

To stop your Hedgetrimmer

- Move Hedgetrimmer away from cutting area before stopping.
1. To stop, release one of the switch levers. (**Fig F**)

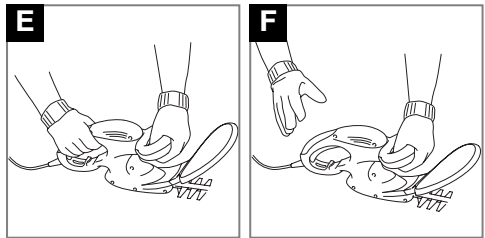

How to Use

How to Use your Hedgetrimmer

1. Inspect area to be cut before each use - remove objects which can be thrown or become entangled in the cutting blades.
2. Always keep the Hedgetrimmer in front of your body. Hold handle firmly with both hands and stand in a secure and stable position.
3. Allow the cutting blades to reach full speed before entering the material to be cut.
4. Always work going away from people and solid objects such as walls, large stones, trees, vehicles etc.
5. If blade stalls, immediately stop the Hedgetrimmer. Disconnect the Hedgetrimmer from the power source and clear jammed debris from the cutting blades. Inspect blades and repair or replace as needed.

Top Cutting

Use a wide sweeping motion. **See Fig. G**. A slight downward tilt of the cutting blades in the direction of motion gives the best cutting results.

Side Cutting

When trimming the sides of the hedge, begin at the bottom and cut upwards (**See Fig. H**), tapering the hedge inward at the top. This shape will expose more of the hedge, resulting in more uniform growth.

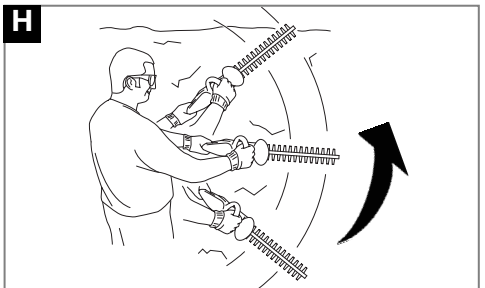
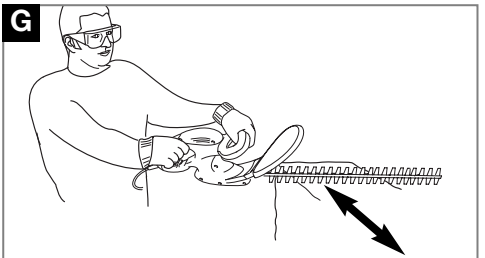

Caring for your Hedgetrimmer

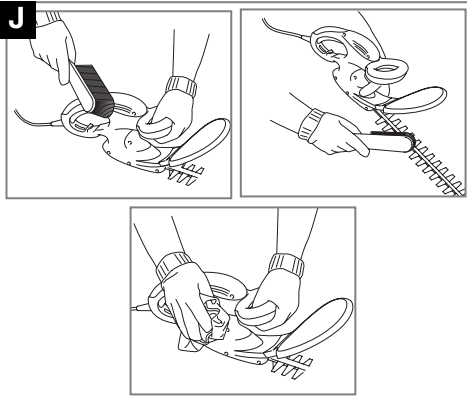

Cleaning (J)

1. Using a soft brush - remove debris from all air intakes and cutting blade.
2. Wipe over surface of your hedgetrimmer with a dry cloth.

- **IMPORTANT**

Never use water for cleaning your hedgetrimmer. Do not clean with chemicals, including petrol, or solvents - some can destroy critical plastic parts.

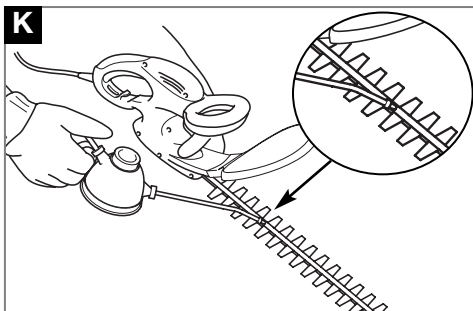

Lubricating the Cutting Blade

For easier operation and longer life, lubricate the cutter blades before and after use. Apply the oil so that it runs between the two blades.

See Pic K.

At the end of the Cutting Season.

1. Clean your Hedgetrimmer thoroughly.
2. Check that all nuts and bolts are secure.
3. Visually inspect the Hedgetrimmer for any worn or damaged parts, contact your local Service Centre if any parts require replacement.

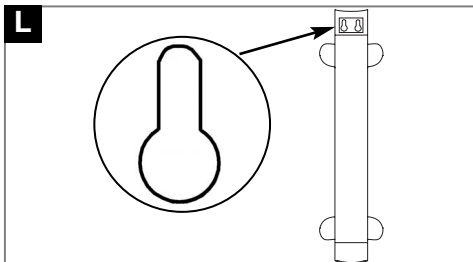

To store your Hedgetrimmer

- The Hedgetrimmer blade cover/storage holder is provided with 2 hanging slots for storing the Hedgetrimmer on the wall. (See Pic L)
 - Ensure the blade cover/storage holder is fitted before storage.
1. The use of 2 number 10 screws (40mm in length) and the appropriate wall fixing plugs is recommended
 2. Drill 2 holes 47mm horizontally apart.
 3. Fit wall plugs.
 4. Fit screw ensuring enough length is available for secure location into hanging slot.
- Your mains cable can be stored with the blade cover/storage holder fitted. (Pic M & N)
 - Store in a dry place where your Hedgetrimmer is protected from damage.

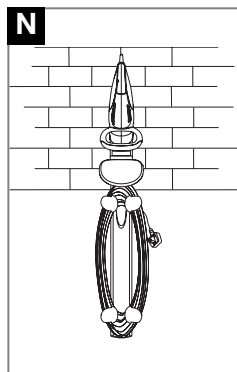
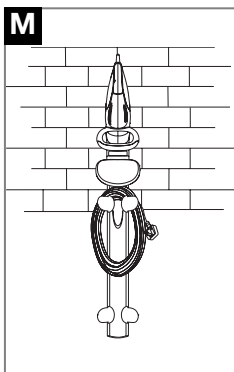

Fault Finding Hints

Fails to Operate

1. Is the Power Turned On?
2. Check the fuse in the plug, if blown replace.
3. Fuse continues to blow?

Immediately disconnect from the mains electricity supply and consult your local approved Service Centre.

Cutting blade stops under load

1. Cut at a slower pace.
2. If cutting blade still stops under load?
Disconnect from the mains electricity supply and consult your local approved Service Centre.

Fails to stop when one switch lever is released. Immediately disconnect from the mains electricity supply and consult your local approved Service Centre.

Poor cut quality

1. Ensure the product is being used correctly (see How to Use)
2. Ensure blades are free from trapped debris
3. Damaged Blades?

Immediately disconnect from the mains electricity supply and consult your local approved Service Centre.



Excessive Vibration

Immediately disconnect from the mains electricity supply and consult your local approved Service Centre.

Environmental Information

Electrolux Outdoor Products are manufactured under an Environmental Management System (ISO 14001) using, where practical, components manufactured in the most environmentally responsible manner, according to company procedures, and with the potential for recycling at the end of the products' life.

- Packaging is recyclable and plastic components have been labelled (where practical) for categorised recycling.
- Awareness of the environment must be considered when disposing of 'end-of-life' product.
- If necessary, contact your local authority for disposal information.

 The symbol  on the product or on its packaging indicates that this product may not be treated as household waste. Instead it shall be handed over to the applicable collection point for the recycling of electrical and electronic equipment. By ensuring this product is disposed of correctly, you will help prevent potential negative consequences for the environment and human health, which could otherwise be caused by inappropriate waste handling of this product. For more detailed information about recycling of this product, please contact your local council office, your household waste disposal service or the shop where you purchased the product.

Guarantee & Guarantee Policy

If any part is found to be defective due to faulty manufacture within the guarantee period, Electrolux Outdoor Products, through its Authorised Service Repairers will effect the repair or replacement to the customer free of charge providing:

- (a) The fault is reported directly to the Authorised Repairer.
 - (b) Proof of purchase is provided.
 - (c) The fault is not caused by misuse, neglect or faulty adjustment by the user.
 - (d) The failure has not occurred through fair wear and tear.
 - (e) The machine has not been serviced or repaired, taken apart or tampered with by any person not authorised by Electrolux Outdoor Products.
 - (f) The machine has not been used for hire.
 - (g) The machine is owned by the original purchaser.
 - (h) The machine has not been used outside of the country for which it was specified.
 - (i) The machine has not been used commercially.
- * This guarantee is additional to, and in no way diminishes the customers statutory rights.

Failures due to the following are not covered, therefore it is important that you read the instructions contained in this Operator's Manual and understand how to operate and maintain your machine:

Failures not covered by guarantee

- * Replacing worn or damaged blades
- * Failures as a result of not reporting an initial fault.
- * Failures as a result of sudden impact.
- * Failures as a result of not using the product in accordance with the instructions and recommendations contained in this Operator's Manual.
- * Machines used for hire are not covered by this guarantee.
- * The following items listed are considered as wearing parts and their life is dependent on regular maintenance and are, therefore not normally subject to a valid warranty claim: Blades, Electric Mains cable.
- * **Caution!** Electrolux Outdoor Products does not accept liability under the warranty for defects caused in whole or part, directly or indirectly by the fitting of replacement parts or additional parts that are not either manufactured or approved by Electrolux Outdoor Products, or by the machine having been modified in any way

Service Recommendations

1. We strongly recommend that your product is serviced at least every twelve months, more often in a professional application.
2. Always use genuine Electrolux Spare Parts.
3. Prepacked spares are available from most Electrolux Outdoor Products stockists.
4. Your product is uniquely identified by a silver and black product rating label
5. If you have a problem with your machine contact your local Approved Service Centre ensuring you have full details of your product as described on the product rating label.
6. **Should it be necessary for work to be carried out by your Service Centre, it is important to**

take your complete machine including cable and any extension cables used.

A network of specialist dealers can be found in your local Yellow Pages. To obtain service on your product simply telephone or visit your local Service Centre. Should you require service under the terms of our guarantee the Service Centre will require proof of purchase.

All of the centres listed stock genuine Electrolux Spare Parts.

NOTE: Our Service Repairers act on their own behalf and are not empowered to commit or legally bind Electrolux Outdoor Products in any manner whatsoever.

Declaration of Conformity

I, the undersigned M. Bowden of Electrolux Outdoor Products, Aycliffe Industrial Park, **NEWTON AYCLIFFE**, Co. Durham. DL5 6UP. Certify that the product:-
 Category..... **Hedgetrimmer**
 Make..... **Electrolux Outdoor Products**
 Conforms to the specifications of Directive 2000/14/EEC

I, the undersigned M. Bowden of Electrolux Outdoor Products, Aycliffe Industrial Park, **NEWTON AYCLIFFE**, Co. Durham. DL5 6UP. Certify that a sample of the above product has been tested using directive 81/1051/EEC as a guide. The maximum A-weighted sound pressure level recorded at operator position under free field semi anechoic chamber conditions was :-

I, the undersigned M. Bowden of Electrolux Outdoor Products, Aycliffe Industrial Park, **NEWTON AYCLIFFE**, Co. Durham. DL5 6UP. Certify that a sample of the above product has been tested using ISO 5349 as a guide. The maximum weighted root mean square value of vibration recorded at operator's hand position was:-

Identification of Series..... See Product Rating Label Conformity Assessment Procedure.... ANNEX VI Notified Body..... L.T.S., Cleeve Road, Leatherhead, Surrey, KT22 7SB England Other Directives:-..... 98/37/EEC, 89/336/EEC, 73/23/EEC & applicable standards:-, EN61000-3-2, EN61000-3-3, EN55014-1, EN55014-2, EN774, EN50144-1, EN50144-2-15	<table style="width: 100%; border-collapse: collapse;"> <tr> <td style="width: 15%;">Type.....</td> <td style="width: 15%;">HT42/HT420</td> <td style="width: 15%;">HT45/HT450</td> <td style="width: 15%;">HT51/HT510</td> <td style="width: 15%;">HT60/HT600</td> </tr> <tr> <td>Blade Length.....</td> <td>42cm</td> <td>45cm</td> <td>51cm</td> <td>60cm</td> </tr> <tr> <td>Guaranteed sound power level...</td> <td>101 dB (A)</td> <td>105 dB (A)</td> <td>101 dB (A)</td> <td>101 dB (A)</td> </tr> <tr> <td>Measured Sound Power Level...</td> <td>98 dB (A)</td> <td>97 dB (A)</td> <td>98 dB (A)</td> <td>98 dB (A)</td> </tr> <tr> <td>Level.....</td> <td>90 dB (A)</td> <td>91 dB (A)</td> <td>95 dB (A)</td> <td>95 dB (A)</td> </tr> <tr> <td>Value.....</td> <td>4.04 m/s²</td> <td>4.6 m/s²</td> <td>7.5 m/s²</td> <td>7.5 m/s²</td> </tr> <tr> <td>Weight.....</td> <td>3.2 Kg</td> <td>3.2 kg</td> <td>3.5 kg</td> <td>3.5 kg</td> </tr> </table>	Type.....	HT42/HT420	HT45/HT450	HT51/HT510	HT60/HT600	Blade Length.....	42cm	45cm	51cm	60cm	Guaranteed sound power level...	101 dB (A)	105 dB (A)	101 dB (A)	101 dB (A)	Measured Sound Power Level...	98 dB (A)	97 dB (A)	98 dB (A)	98 dB (A)	Level.....	90 dB (A)	91 dB (A)	95 dB (A)	95 dB (A)	Value.....	4.04 m/s²	4.6 m/s²	7.5 m/s²	7.5 m/s²	Weight.....	3.2 Kg	3.2 kg	3.5 kg	3.5 kg
Type.....	HT42/HT420	HT45/HT450	HT51/HT510	HT60/HT600																																
Blade Length.....	42cm	45cm	51cm	60cm																																
Guaranteed sound power level...	101 dB (A)	105 dB (A)	101 dB (A)	101 dB (A)																																
Measured Sound Power Level...	98 dB (A)	97 dB (A)	98 dB (A)	98 dB (A)																																
Level.....	90 dB (A)	91 dB (A)	95 dB (A)	95 dB (A)																																
Value.....	4.04 m/s²	4.6 m/s²	7.5 m/s²	7.5 m/s²																																
Weight.....	3.2 Kg	3.2 kg	3.5 kg	3.5 kg																																

Newton Aycliffe, 16/08/2004
 M. Bowden,
 Research & Development Director

Electrolux Outdoor Products
 Aycliffe Industrial Park
 NEWTON AYCLIFFE
 Co. Durham DL5 6UP
ENGLAND

Telephone - (00) 44 1325 300303 Fax - (00) 44 1325 310339

Our policy of continuous improvement means that the specification of products may be altered from time to time without prior notice. Electrolux Outdoor Products manufacture products for a number of well known brands under various registered patents, designs and trademarks in several countries.

© Electrolux Outdoor Products Ltd. Registered Office, Electrolux Works, Oakley Road, Luton LU4 9QQ
 Registered number 974979 England

The Electrolux Group. The world's No. 1 choice.

The Electrolux Group is the world's largest producer of powered appliances for kitchen, cleaning and outdoor use. More than 55 million Electrolux Group products (such as refrigerators, cookers, washing machines, vacuum cleaners, chain saws and lawn mowers) are sold each year to a value of approx. USD 14 billion in more than 150 countries around the world.

5119561-02

