

Flymo

Turbo Lite

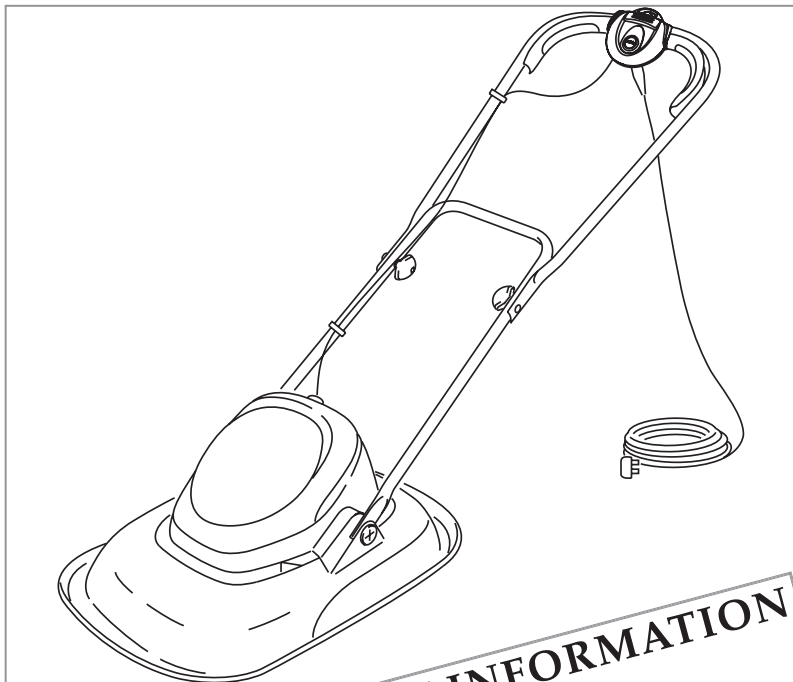

Original Instructions



IMPORTANT INFORMATION
Read before use
& retain for future reference



For all customer enquiries or for replacement parts, contact:-

☎ 0870 609 1901

🖱 www.flymo.com



customer.services@husqvarna.co.uk

Carton Contents

IMPORTANT ! Please check the contents of the carton are correct **BEFORE** assembling your new Flymo product.

IF ANY PARTS ARE MISSING

CONTACT:-

Husqvarna UK Ltd. Customer Service Department direct
Telephone : 0870 609 1901
Fax : 0870 609 1902

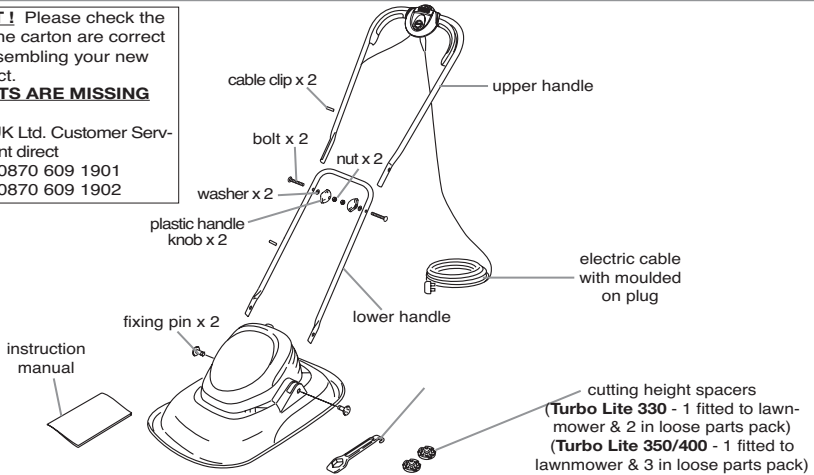

Safety



If not used properly this product can be dangerous! This product can cause serious injury to the operator and others, the warnings and safety instructions must be followed to ensure reasonable safety and efficiency in using this product. The operator is responsible for following the warning and safety instructions in this manual and on the product.

Explanation of Symbols on your product



Warning



Read the user instructions carefully to make sure you understand all the controls and what they do.



Always keep the product on the ground when mowing. Tilting or lifting the lawnmower may cause stones to be thrown out.



Keep bystanders away. Do not operate whilst people especially children or pets are in the mowing area.

Switch off! Remove plug from mains before adjusting, cleaning or if cable is entangled or damaged. Keep the cable away from the blade.



Beware of severing toes or hands. Do not put hands or feet near a rotating blade.



Keep the cable supply away from the cutting means



General

- This product is not intended for use by persons (including children) with reduced physical, sensory or mental capabilities, or lack of experience and knowledge, unless they have been given supervision or instruction concerning the use of the product by a person responsible for their safety. Children should be supervised to ensure that they do not play with the product. Local regulations may restrict the age of the operator.
- Only use the product in the manner and for the functions described in these instructions.
- Never operate the product when you are tired, ill or under the influence of alcohol, drugs or medicine.
- The operator or user is responsible for accidents or hazards occurring to other people or their property.

Electrical

- The British Standards Institute recommend the use of a Residual Current Device (R.C.D.) with a tripping current

of not more than 30mA. Even with a R.C.D. installed 100% safety cannot be guaranteed and safe working practice must be followed at all times. Check your R.C.D. every time you use it.

- Before use, examine cable for damage, replace it if there are signs of damage or ageing.
- Do not use the product if the electric cables are damaged or worn
- Immediately disconnect from the mains electricity supply if the cable is cut, or the insulation is damaged. Do not touch the electric cable until the electrical supply has been disconnected. Do not repair a cut or damaged cable. Replace it with a new one.
- Your extension cable must be uncoiled, coiled cables can overheat and reduce the efficiency of your product.
- Keep cable away from product, always work away from the power point mowing up and down, never in circles.

7. Always switch off at the mains before disconnecting any plug, cable connector or extension cable.
8. Switch off, remove plug from mains and examine electric supply cable for damage or ageing **before** winding cable for storage. Do not repair a damaged cable, replace it with a new one. Use only Flymo replacement cable.
9. Always wind cable carefully, avoiding kinking.
10. Never carry the product by the cable.
11. Never pull on the cable to disconnect any of the plugs.
12. Use only on AC mains supply voltage shown on the product rating label.
13. Flymo products are double insulated to EN60335. Under no circumstances should an earth be connected to any part of the product.

Preparation

1. While using your product always wear substantial footwear and long trousers.
2. Make sure the lawn is clear of sticks, stones, bones, wire and debris; they could be thrown by the blade.
3. Before using the product and after any impact, check for signs of wear or damage and repair as necessary.
4. Replace worn or damaged blades together with their fixings in sets to preserve balance.

Use

1. Use the product only in daylight or good artificial light.
2. Avoid operating your product in wet grass, where feasible.
3. Take care in wet grass, you may lose your footing.
4. On slopes, be extra careful of your footing and wear non-slip footwear.
5. Operate across the face of slopes, never up and down.
6. Exercise extreme caution when changing direction on slopes. Walk never run.
7. Operating on banks and slopes can be dangerous. Do not operate on **banks** or **steep** slopes.
8. Do not walk backwards when operating, you could trip.

9. Never cut grass by pulling the product towards you.
10. Switch off before pushing the product over surfaces other than grass.
11. Never operate the product with damaged guards or without guards in place.
12. Keep hands and feet away from the cutting means at all times and especially when switching on the motor.
13. Do not tilt product when the motor is running, except when starting and stopping. In this case, do not tilt more than absolutely necessary and lift only the part which is away from the operator. Always ensure that both hands are in the operating position before returning the product to the ground.
14. Never pick up or carry the product when it is operating or still connected to the mains supply.
15. Remove the plug from the mains :
 - before leaving the product unattended for any period;
 - before clearing a blockage;
 - before checking, cleaning or working on the appliance;
 - if you hit an object. Do not use your product until you are sure that the entire product is in a safe operating condition.;
 - if the product starts to vibrate abnormally. Check immediately. Excessive vibration can cause injury.

Maintenance and storage

1. Keep all nuts, bolts and screws tight to be sure the lawnmower is in safe working condition.
2. Replace worn or damaged parts for safety.
3. Only use the replacement blade, blade bolt, spacers and impeller specified for this product.
4. Be careful during adjustment of the product to prevent entrapment of the fingers between moving blades and fixed parts of the machine.

CABLES IMPORTANT

- Use only 1.00mm² size cable up to 40 metres length maximum.

Maximum rating :

- 1.00mm² size cable, 10 amps 250 volts AC.
 - **THE TURBO LITE 330 IS SUPPLIED WITH CABLE WIRED DIRECTLY INTO THE PRODUCT.**
 - **THE TURBO LITE 350/400 IS SUPPLIED WITH AN ELECTRIC MAINS CABLE FITTED WITH A FEMALE CONNECTOR**
1. Flymo Mains Cables and Extension Cables are available from your local Approved Service Centre.
 2. Do not wire an extension cable directly to your product yourself. Please contact your local Approved Service Centre for further information on the connectors and kits available.
 3. Only use extension cables specifically designed for outdoor use.

CONNECTORS IMPORTANT

- Flymo connectors are suitable for use with 2 core cable only. Under no circumstances should these connectors be used for earthed products.
- All Flymo connectors and cables are of splash-proof construction. They are not waterproof and must not be left outside permanently nor should they be submerged or immersed in water. Do not let cable lay or trail through pools of water or splashed with water from hose pipes.

MAINS PLUG REPLACEMENT IMPORTANT

- **If the plug supplied is cut off it should be destroyed. There is an electric shock hazard if a cut off plug is inserted into a 13 amp socket.**
1. **No earth required.** Flymo products are double insulated to EN60335 and under no circumstances should an earth be connected to any part of the product.
 2. **Ensure the mains voltage suits your product IMPORTANT!**
The wires in the mains lead are coloured in accordance with the following code:
BLUE - NEUTRAL
BROWN - LIVE
The wire which is coloured BLUE must be connected to the Terminal which is marked with the letter 'N' or coloured BLACK.
The wire which is coloured BROWN must be connected to the Terminal which is marked with the letter 'L' or coloured RED.
 4. It is important that the outer sheath is clamped correctly into the 3-pin plug.
 5. If in doubt consult your local Service Repairer or qualified electrician before the machine is used.
 6. **A 13 Amp fuse must be fitted to the Mains Plug.**
 7. The normal plug fuse and household fuse only protect the electrical equipment and are not a safeguard against electrocution.

If your product is hard wired i.e. non-detachable mains electric cable, a conversion kit and extension cable is available from all Approved Service Centres which can be found in your local Yellow Pages.

Assembly

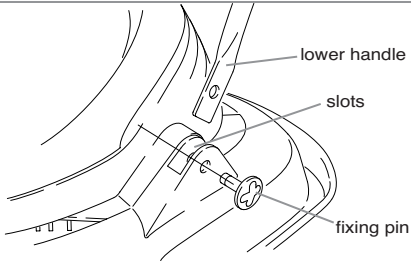
A

Fitting the Lower Handles to Your Lawnmower (A)

1. Place the end of the lower handle into the slots.
 2. Secure lower handles to hood by firmly pushing fixing pin through holes in hood and handle.
 3. Repeat on the other side.
- **NOTE**
Should a problem occur when securing handle to hood with the fixing pin, carefully lever fixing pin out of location and repeat steps 1 to 3 above.

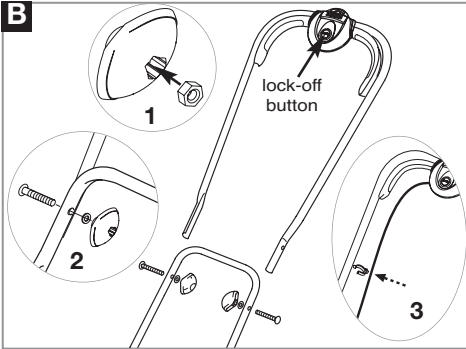
B

Fitting Upper Handles to Lower Handles (B)

1. Ensure the upper handle is located correctly with the lock-off button on the switchbox uppermost.
2. Ensure the upper handle and the lower handle are aligned correctly.
3. Insert the nut into the handle knob (B1).
4. Fit the bolts, washers and handle knobs (B2).
5. Fit the cable to the handles with the clips provided. Make sure the cable is not trapped between the upper and lower handles (B3).

Handle Adjustment

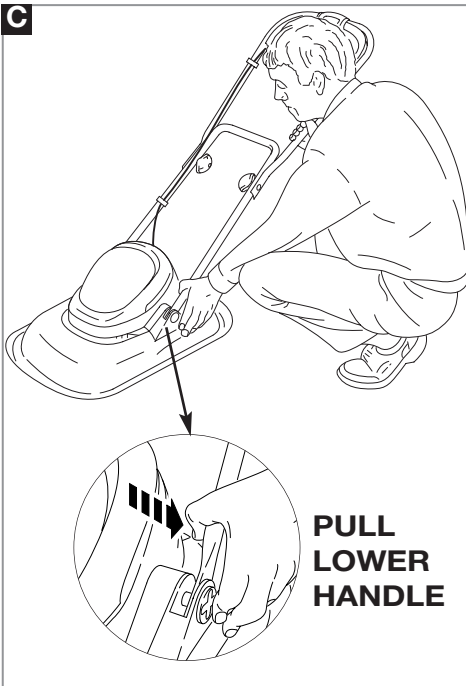
C

- **WARNING! STOP THE LAWNMOWER AND WAIT UNTIL THE BLADE HAS STOPPED ROTATING BEFORE ADJUSTING THE HANDLE.**
- **NOTE! REMOVAL OF LOWER HANDLE FIXING PINS IS NOT REQUIRED TO ADJUST THE HANDLE**

TO ADJUST THE HANDLE (C)

1. Hold handle as illustrated.
2. Take the weight of the handle with your right hand...
3. ...then grip the lower part of the handle with your left hand...
4. ...and **pull** the lower handle towards you with your left hand.
5. Move to forward or down position as required.

HANDLE IN FORWARD POSITION

Follow procedure described in "TO ADJUST THE HANDLE" and push handle forward until it stops.

HANDLE IN DOWN POSITION

Follow procedure described in "TO ADJUST THE HANDLE" and move handle downward until it stops. **NOTE - The handle does not rest flat on the ground.**

HANDLE IN OPERATING POSITION

Adjustment is not required to move the handle to the operating position

Simply pull down from the forward position **or** lift up from the down position until the handle is in the most comfortable operating position.

Starting and Stopping

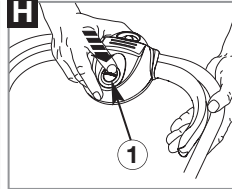
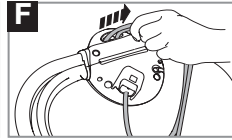
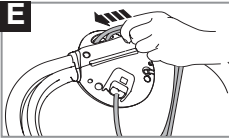
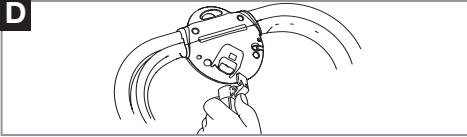

To Start your Lawnmower

1. Connect female extension cable connector to the back of the switchbox. (**Turbo Lite 350/400 only**) (**D**)
2. Form loop in mains cable and push the loop through the slot as illustrated in picture (**E**)
3. To secure, position loop over the hook and pull the cable back through the slot as illustrated in picture (**F**).
4. Connect plug to mains and switch on.
5. Move handle to the mowing position.
6. To prevent a ring being cut in your lawn, tilt your lawnmower slightly (**G**).

The switchbox is provided with a lock-off button (H1) to prevent accidental starting.

7. Press and hold the lock-off button (**H1**) on the switchbox, then squeeze one of the Start/Stop levers towards the upper handle (**J**).
8. Continue to squeeze the start/stop lever towards the upper handle and release the lock-off button.
9. When the lawnmower has reached full speed gently lower it onto the lawn.

- **NOTE There are two start/stop levers fitted. Either one can be used for starting the lawnmower.**
- **IMPORTANT**

Do not use the start/stop levers intermittently
To Stop your Lawnmower

1. To prevent a ring being cut in your lawn, tilt your lawnmower slightly (**G**).
2. Release the pressure on the Start/Stop lever.

How to Mow

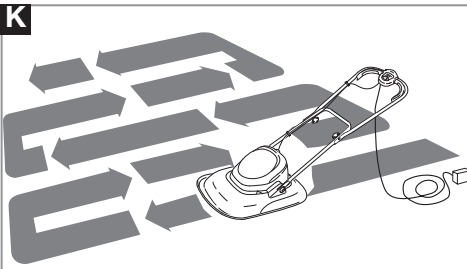

1. Start mowing the edge of the lawn nearest to the power point so the cable is laid out on the lawn you have already cut. (**K**)
2. Cut your grass twice a week during the growing season, your lawn will suffer if more than a third of its length is cut at one time.

Do Not Overload Your Mower

Mowing long thick grass may cause the motor speed to drop, you will hear a change in the motor sound. If the motor speed drops you may overload your lawnmower which may cause damage. When mowing in long thick grass a first cut with the cutting height set higher will help reduce the load. See Adjusting the Cutting Height.

Adjusting the Cutting Height

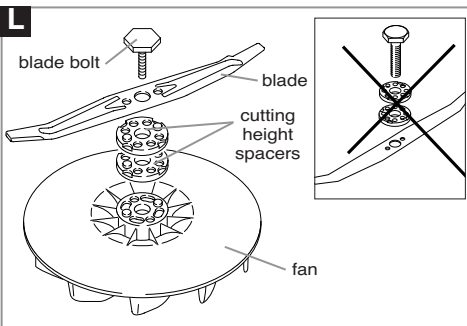

Always handle the blade with care - sharp edges could cause injury. USE GLOVES. Never use more than 3 Cutting Height Spacers for the Turbo Lite 330 OR 4 Cutting Height Spacers for the Turbo Lite 350/400. Spacers must only be fitted between the blade and the fan and NEVER between the blade and the bolt.

1. Remove the blade bolt, and blade as described in **Removing the Blade and Fan**.
2. **For a Lower Cut** - Add spacers to a maximum of 3 for Turbo Lite 330, or 4 for Turbo Lite 350/400. (**L**)
3. **For a Higher Cut** - Take spacers away.
4. Refit the blade as described in **Fitting the Blade and Fan**.

Removing the Blade and Fan

1. To remove the blade bolt, hold the fan firmly and with the spanner provided loosen the blade bolt by turning it anti-clockwise (**M**).
2. Remove the blade bolt, blade, spacers and fan.
3. Inspect for damage and clean as necessary.
- **Renew your metal blade after 50 hours mowing or 2 years whichever is the sooner - regardless of condition.**

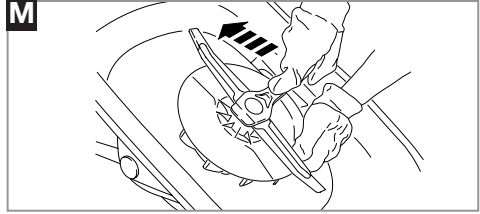

Fitting the Blade and Fan

- **If the blade is cracked or damaged replace it with a new one.**
 - **Never use a blade bolt if the insulated head is damaged cracked or missing.**
1. Ensure the fan is located correctly.
 2. Place the spacers onto the fan ensuring the pegs have located into the holes.
 3. Place the blade onto the spacers ensuring the pegs have located into the holes on the blade and ensuring the blade is positioned as illustrated in **Figure N**.
 4. Place the blade bolt through the centre hole of the blade.(**N**)
 5. Tighten down clockwise by hand.
 6. Hold the fan firmly and tighten the blade bolt with the spanner provided.

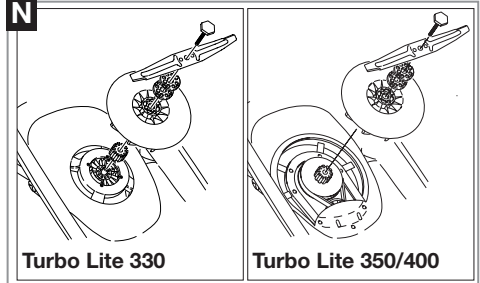

Caring for your Lawnmower

Cleaning (USE GLOVES) (P)

It is very important that you keep your lawnmower clean. Grass clippings left in any of the air intakes or under the hood could become a potential fire hazard.

1. Remove grass from under the hood with a piece of wood or similar.
2. Using a soft brush - remove grass clippings from **all** air intakes.
3. Remove the blade, **see Figure M**, to gain access to the fan and clean with a soft brush.
4. Wipe over the surface of your lawnmower with a dry cloth.

• IMPORTANT

Never use water for cleaning your lawnmower. Do not clean with chemicals, including petrol, or solvents - some can destroy critical plastic parts.

At the End of the Mowing Season

1. Replace blade, bolts, nuts or screws, if necessary.
2. Clean your lawnmower thoroughly.
3. Ask your local Service Centre to clean the air filter thoroughly and carry out any service or repairs required.
4. Make sure that the electric cable is coiled properly.

Carrying your Lawnmower

Ensure the blade is facing away from you.

Storing your Lawnmower

Store in a dry place where your lawnmower is protected from damage.

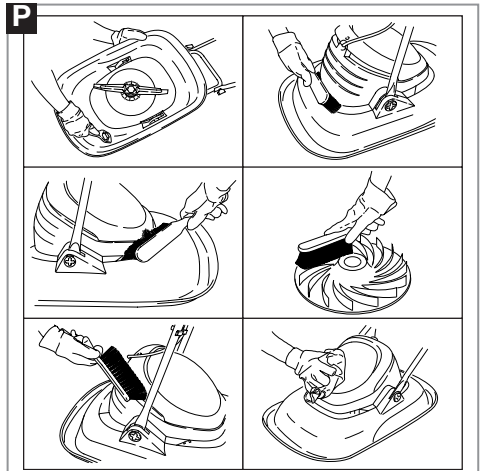

Fault Finding Hints

Fails to Operate

1. Is the Power Turned On?
2. Check the fuse in the plug, if blown replace.
3. Fuse continues to blow?

Immediately disconnect from the mains electricity supply and consult your local approved Service Centre.

Poor Flotation

1. Disconnect from the mains electricity supply.
2. Clean the underside of the hood and the fan blades.
3. Raise to a higher height of cut. See Adjusting the Height of Cut.
4. If poor flotation persists?

Disconnect from the mains electricity supply and consult your local approved Service Centre.

Excessive Vibration

1. Disconnect from the mains electricity supply.
2. Check that the blade is fitted correctly?
3. If the blade is damaged or worn, replace it with a new one.
4. If vibration persists?

Immediately disconnect from the mains electricity supply and consult your local approved Service Centre.

Service Recommendations

1. We strongly recommend that your product is serviced at least every twelve months, more often in a professional application.
2. Always use genuine Flymo Spare Parts.
3. Prepacked spares are available from most Husqvarma UK Ltd. stockists.
4. Your product is uniquely identified by a silver and black product rating label
5. If you have a problem with your machine contact your local Approved Service Centre ensuring you have full details of your product as described on the product rating label.
6. **Should it be necessary for work to be carried out by your Service Centre, it is important to take your complete machine including cable and any extension cables used.**

A network of specialist dealers can be found in your local Yellow Pages.

To obtain service on your Flymo product simply telephone or visit your local Service Centre.

Should you require service under the terms of our guarantee the Service Centre will require proof of purchase.

All of the centres listed stock genuine Flymo Spare Parts.

NOTE:

Our Service Repairers act on their own behalf and are not empowered to commit or legally bind Husqvarma UK Ltd. in any manner whatsoever.

Guarantee & Guarantee Policy

If any part is found to be defective due to faulty manufacture within the guarantee period, Husqvarma UK Ltd., through its Authorised Service Repairers will effect the repair or replacement to the customer free of charge providing:

- (a) The fault is reported directly to the Authorised Repairer.
 - (b) Proof of purchase is provided.
 - (c) The fault is not caused by misuse, neglect or faulty adjustment by the user.
 - (d) The failure has not occurred through fair wear and tear.
 - (e) The machine has not been serviced or repaired, taken apart or tampered with by any person not authorised by Husqvarma UK Ltd.
 - (f) The machine has not been used for hire.
 - (g) The machine is owned by the original purchaser.
 - (h) The machine has not been used commercially.
- * This guarantee is additional to, and in no way diminishes the customers statutory rights.

Failures due to the following are not covered, therefore it is important that you read the instructions contained in this Operator's Manual and understand how to operate and maintain your machine:

Failures not covered by guarantee

- * Replacing worn or damaged blades
- * Failures as a result of not reporting an initial fault.
- * Failures as a result of sudden impact.
- * Failures as a result of not using the product in accordance with the instructions and recommendations contained in this Operator's Manual.
- * Machines used for hire are not covered by this guarantee.
- * The following items listed are considered as wearing parts and their life is dependent on regular maintenance and are, therefore not normally subject to a valid warranty claim: Blades, Electric Mains cable.
- * **Caution!**
Husqvarma UK Ltd. does not accept liability under the warranty for defects caused in whole or part, directly or indirectly by the fitting of replacement parts or additional parts that are not either manufactured or approved by Husqvarma UK Ltd., or by the machine having been modified in any way

Environmental Information

Husqvarma UK Ltd. are manufactured under an Environmental Management System (ISO 14001) using, where practical, components manufactured in the most environmentally responsible manner, according to company procedures, and with the potential for recycling at the end of the products' life.

- Packaging is recyclable and plastic components have been labelled (where practical) for categorised recycling.
- Awareness of the environment must be considered when disposing of 'end-of-life' product.
- If necessary, contact your local authority for disposal information.

The symbol  on the product or on its packaging indicates that this product may not be treated as household waste. Instead it shall be handed over to the applicable collection point for the recycling of electrical and electronic equipment.

By ensuring this product is disposed of correctly, you will help prevent potential negative consequences for the environment and human health, which could otherwise be caused by inappropriate waste handling of this product.

For more detailed information about recycling of this product, please contact your local council office, your household waste disposal service or the shop where you purchased the product.

EC Declaration of Conformity

Husqvarna UK Ltd., Aycliffe Industrial Park
Newton Aycliffe, Co. Durham, DL5 6UP, England

Declare under our sole responsibility that the product(s);

Category.....**Electric Rotary Lawnmower**
Type(s)**TL330, TL350, TL400**
Identification of Series.....**See Product Rating Label**
Year of Construction.....**See Product Rating Label**

Conforms to the essential requirements & provisions of the following EC Directives:
98/37/EC (until 31.12.09), 2006/42/EC (from 01.01.10), 2004/108/EC, 2000/14/EC
based on the following EU harmonized standards applied:
EN60335-1, EN60335-2-77, EN836, EN50366, EN55014-1, EN61000-3-2, EN61000-3-3

The maximum A weighted sound pressure level L_{pA} at the operator's position, recorded on a sample of the above product(s) corresponds to the **Level** given in the table.

The maximum hand / arm vibration weighted value measured according to EN ISO 5349 on a sample of the above product(s) corresponds to the **Value** given in the table.

2000/14/EC: The Measured Sound Power L_{WA} & Guaranteed Sound Power L_{WA} values are according to the tabulated figures.

Conformity Assessment Procedure..... Annex VI
Notified Body..... Intertek, Cleeve Road
Leatherhead, Surrey
KT22 7SB, England

Newton Aycliffe 8/11/2007
M.Bowden
Research & Development Director
Husqvarna UK Ltd.



Type	TL330	TL350	TL400
Width of Cut (cm)	33	35	40
Speed of Rotation of Cutting Device (rpm)	6,300	4,100	4,100
Power (kW)	1.15	1.4	1.5
Measured Sound Power L_{WA} (dB(A))	95	95	95
Guaranteed Sound Power L_{WA} (dB(A))	96	96	95
Level (dB(A))	82.4	85.7	82.7
Value (m/s^2)	0.801	5.44	1.22
Weight (Kg)	6.5	7.5	7.5

Husqvarna UK Ltd.
Aycliffe Industrial Park
NEWTON AYCLIFFE
Co.Durham DL5 6UP
ENGLAND

Telephone - (00) 44 1325 302302 Fax - (00) 44 1325 310339

Our policy of continuous improvement means that the specification of products may be altered from time to time without prior notice.

