



PowerMax 36 E
Art. 4037
PowerMax 42 E
Art. 4043

D Betriebsanleitung
Elektro-Rasenmäher

GB Operating Instructions
Electric Lawnmower

F Mode d'emploi
Tondeuse électrique

NL Instructies voor gebruik
Elektrische grasmaaier

S Bruksanvisning
Elektrisk Gräsklippare

DK Brugsanvisning
Elektrisk Plæneklipper

N Bruksanvisning
Elektrisk Gressklipper

FIN Käyttöohje
Tehokas sähköleikkuri

I Istruzioni per l'uso
Rasaerba elettrico

E Manual de instrucciones
Cortacésped eléctrico

P Instruções de utilização
Máquina de cortar relva eléctrica

PL Instrukcja obsługi
Elektryczna kosiarka

H Vevõtájékoztató
Elektromos fűnyíró

CZ Návod k obsluze
Elektrická sekačka

SK Návod na používanie
Elektrická kosačka

GR Οδηγίες χρήσεως
Ηλεκτρική χλοοκοπτική μηχανή

RUS Инструкция по эксплуатации
Электрические газонокосилки

SLO Navodila za uporabo
Električna kosilnica

HR Uputstva za upotrebu
Električna kosilica

UA Інструкція з експлуатації
Електрична газонокосарка

RO Instrucțiuni de utilizare
Masina electrica de tuns gazonul

TR Kullanma Talimatı
Elektrikli Çim Biçme Makinesi

BG Инструкция за експлоатация
Електрокосачка

EST Kasutusjuhend
Elektriline muruniiduk

LT Eksploatavimo instrukcija
Elektrinė veļarpjovė

LV Lietošanas instrukcija
Elektriskā zāles pļaujmašīna

D

GB

F

NL

S

DK

N

FIN

I

E

P

PL

H

CZ

SK

GR

SLO

RUS

HR

SLO

UA

RO

TR

BG

EST

LT

LV

- D** **WICHTIGE INFORMATION**
Bitte vor dem Benutzen des Gerätes durchlesen und gut aufbewahren
- GB** **IMPORTANT INFORMATION**
Read before use and retain for future reference
- F** **RENSEIGNEMENTS IMPORTANTS**
A lire avant usage et à conserver pour référence ultérieure
- NL** **BELANGRIJKE INFORMATIE**
Leest u deze informatie voor het gebruik en bewaar ze voor toekomstige raadpleging
- S** **VIKTIG INFORMATION**
Läs anvisningarna före användningen och spara dem för framtida behov
- DK** **VIGTIGE OPLYSNINGER**
Du bør læse brugsanvisningen før brug og gemme til senere henvisning
- N** **VIKTIG INFORMASJON**
Les bruksanvisningen nøye før bruk og oppbevar den for senere bruk
- FIN** **VIGTIGE OPLYSNINGER**
Du bør læse brugsanvisningen før brug og gemme til senere henvisning
- I** **INFORMAZIONI IMPORTANTI**
Leggere prima dell'uso e conservare per ulteriore consultazione
- E** **INFORMACIÓN IMPORTANTE**
Léase antes de utilizar y consérvela como referencia en el futuro
- P** **INFORMAÇÕES IMPORTANTES**
Leia antes de utilizar e guarde para consulta futura
- PL** **UWAGA** Zapoznać się z treścią niniejszej instrukcji przed użyciem i zachować ją do dalszego użytkowania urządzenia
- H** **FONTOS INFORMÁCIÓ**
Használat előtt olvassa el, és tartsa meg későbbi felhasználásra
- CZ** **DŮLEŽITÁ INFORMACE**
Než začnete stroj používat, přečtěte si pozorně tento návod a uschovejte jej pro další použití v budoucnu
- SK** **DÔLEŽITÉ INFORMÁCIE**
Pred použitím si prečítajte nasledovné informácie a odložte si ich pre budúcu potrebu
- GR** **ΣΗΜΑΝΤΙΚΕΣ ΠΛΗΡΟΦΟΡΙΕΣ**
Διαβάστε αυτό το φυλλάδιο πριν από τη χρήση της συσκευής και φυλάξτε το για μελλοντική αναφορά
- RUS** **ВАЖНАЯ ИНФОРМАЦИЯ**
Прочитайте перед тем, как включить триммер, и сохраните для дальнейшего использования.
- SLO** **POMEMBNA INFORMACIJA**
Preberite pred uporabo in shranite za prihodnjo uporabo
- HR** **VAŽNE INFORMACIJE**
Pročitati prije upotrebe i sačuvati za buduće osvrte
- UA** **ВАЖЛИВА ІНФОРМАЦІЯ**
Прочитайте перед початком роботи і збережіть для подальшого використання
- RO** **Manual de instrucțiuni**
Înainte să folosiți mașina de tuns pentru prima oară, citiți cu atenție manualul de instrucțiuni pentru a-i înțelege conținutul.
- TR** **ÖNEMLİ BİLGİLER**
Kullanmadan önce okuyunuz ve ileride başvurmak üzere saklayınız.
- BG** **ВАЖНА ИНФОРМАЦИЯ**
Прочетете преди употреба и запазете за бъдещи справки
- EST** **OLULINE TEAVE**
Enne seadme kasutuselevõtmist lugege kasutusjuhend läbi ning säilitage see tuleviku tarbeks.
- LT** **Operatoriaus instrukcijų rinkinys**
Perskaitykite šį instrukcijų rinkinį labai atidžiai, kad pilnai suprastumėte turinį, prieš pradėdami naudoti vejos/ žolės pjovėją.
- LV** **ВАЖЛИВА ІНФОРМАЦІЯ**
Прочитайте перед початком роботи і збережіть для подальшого використання

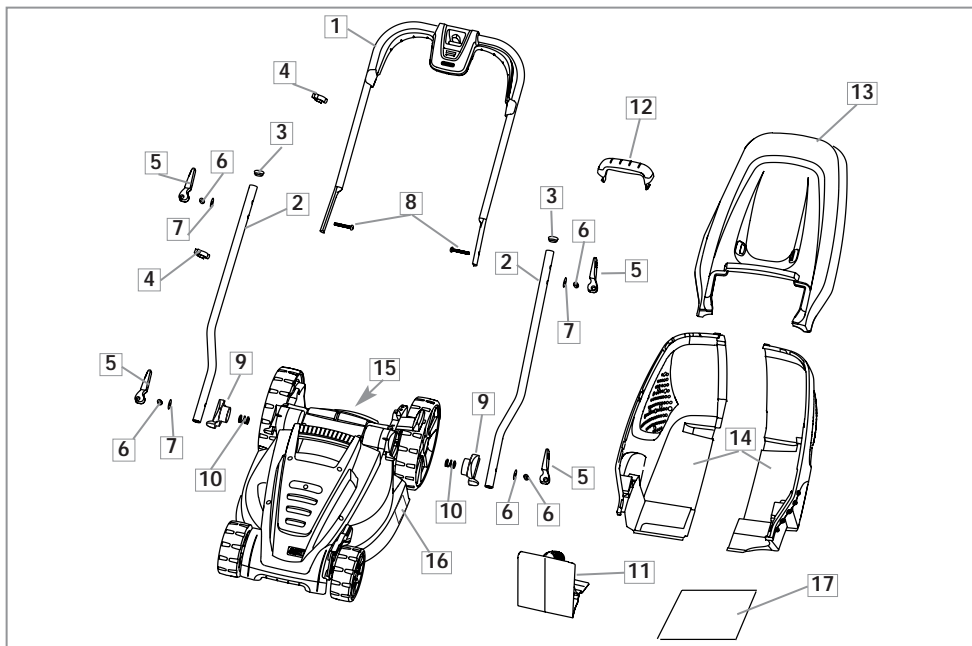

D - INHALT

1. Holm-Oberteil
2. Holm-Unterteil x 2
3. Endkappe Holm-Unterteil x 2
4. Kabelhalter x 2
5. Spannhebel x 4
6. Gewindebolzen x 4
7. Unterlegscheibe x 4
8. Schraube x 2
9. Holmaufnahme x 2
10. Feder x 2
11. Mulchkit
12. Tragegriff
13. Oberteil Fangbox
14. Unterteil Fangbox x 2
15. Warnsymbole
16. Produkttypenschild
17. Bedienungsanweisung

GB - CONTENTS

1. Upper handle
2. Lower handle x 2
3. Lower handle plug x 2
4. Cable clip x2
5. Cam Lock x 4
6. Barrel Nut x 4
7. Washer x 4
8. Bolt x 2
9. Pivot Block x 2
10. Spring x 2
11. Mulching Plug
12. Grassbox handle
13. Grassbox Upper
14. Grassbox lower x 2
15. Warning Symbols
16. Product rating label
17. Instruction Manual

F - TABLE DES MATIÈRES

1. Guidon supérieur
2. Guidon inférieur x 2
3. Embout de la poignée inférieure x 2
4. Attache câble x 2
5. Clavette de came x 4
6. Ecrou tube x 4
7. Rondelles x 4

8. Boulons x 2
9. Cale de rotation x 2
10. Ressort x 2
11. Pièce pour le paillage
12. Poignée du bac
13. Partie supérieure du bac
14. Partie inférieure du bac x 2
15. Etiquette de précautions d'emploi
16. Plaquette des Caractéristiques du Produit

NL - INHOUD

1. Bovenstuk van duwboom
2. Onderstuk van duwboom x 2
3. Dop van onderste handgreep x 2
4. Snoerklem x 2
5. Sluitnok x 4
6. Cilinderbout x 4
7. Pakkingring x 4
8. Bout x 2
9. Scharnierblok x 2
10. Veer x 2
11. Mulchplug
12. Handgreep grasbak
13. Bovenste deel grasvangbak
14. Onderste deel grasvangbak x 2
15. Waarschuwingssymbool
16. Product-informatielabel
17. Handleiding

S - INNEHÅLL

1. Övre handtag
2. Nedre handtag 2 st
3. Plugg för undre handtag x 2
4. Kabelklämma 2 st
5. Kamlås x 4
6. Valsmutter x 4
7. Bricka 4 st
8. Bult 2 st
9. Drejeblok x 2
10. Fjäder x 2
11. Plugg för flistugg
12. Handtag för gräsoppsamlare
13. Gräslådans överdel
14. Gräslådans

- underdel x 2
15. Varningssymboler
16. Produktmärkning
17. Bruksanvisning

DK - INDHOLD

1. Øvre håndtag
2. Nedre håndtag x 2
3. Prop til det nederste håndtag X 2
4. Kabelklemme x 2
5. Låsearm x 4
6. Tromlemøtrik x 4
7. Spændeskive x 4
8. Bolt x 2
9. Drejeblok x 2
10. Fjeder x 2
11. Komposteringsprop
12. Opsamlerhåndtag
13. Øverste del af græsboksen
14. Nederste del af græsboksen x 2
15. Advarselsymboler
16. Produktets mærkeskilt
17. Brugsvejledning

N - INNHOLD

1. Øvr håndtak
2. Nedre håndtak x 2
3. Plasthette til nedre håndtak x 2
4. Kabelklemme x 2
5. Kamlås x 4
6. Hylsemutter x 4
7. Skive x 4
8. Bolt x 2
9. Dreibar brakett x 2
10. Fjær x 2
11. Bioplugg
12. Håndtak til gressoppsamler
13. Øvre del av gressoppsamlaren
14. Nedre del av gressoppsamlaren x 2
15. Waarschuwingssymbolen
16. Produktmerking
17. Bruksanvisning

FIN - SISÄLTÖ

1. Ylempi kahva
2. Alempi kahva x 2
3. Alakahvan tulppa x 2
4. Johdon pidike x 2
5. Lukitsin x 4
6. Hylsymutteri x 4
7. Tiivistysrengas x 4
8. Pulltti x 2
9. Säättökiekko x 2
10. Jousi x 2
11. Biroleikkuriosa
12. Ruohonkerääjän kahva
13. Ruoholaatikon yläosa
14. Ruoholaatikon alaosa x 2
15. Varoitusmerkit
16. Ruohonleikkurin arvokilpi
17. Käyttöopas

I - INDICE CONTENUTI

1. Impugnatura superiore
2. Impugnatura inferiore x 2
3. Tappo manico inferiore x 2
4. Morsetto per il cavo x 2
5. Fermo a camma x 4
6. Dado lungo x 4
7. Rondella x 4
8. Bullone x 2
9. Blocco perno x 2
10. Molla x 2
11. Coperchio pacciamme
12. Maniglia cesto raccogliherba
13. Parte superiore del cesto raccogliherba
14. Parte inferiore del cesto raccogliherba x 2
15. Simboli di avvertenza
16. Etichetta dati del prodotto
17. Manuale di istruzioni

E - CONTENIDO

1. Empuñadura superior inferior x 2
2. Empuñadura inferior x 2
3. Tapón de la barras inferiores x 2
4. Grapa de cable x 2
5. Cierre de leva x 4
6. Tuerca cilíndrica x 4
7. Arandela x 4
8. Perno x 2
9. Bloque de pivote x 2
10. Resorte x 2
11. Tapón del mantillo
12. Mango del recogedor
13. Caja Superior de Césped
14. Caja Inferior de Césped x 2
15. Símbolos de alarma
16. Placa de Características del Producto
17. Manual de instrucciones

P - LEGENDA

1. Guiador superior
2. Guiador inferior x 2
3. Bucha do manipulador inferior x 2
4. Grampo do cabo x 2
5. Bloqueio de came x 4
6. Porca cilíndrica x 4
7. Anilha x 4
8. Cavilha x 2
9. Bloqueio do pivot x 2
10. Mola x 2
11. Tampão para espalhar relva
12. Pega da Caixa da Relva
13. Parte superior do depósito de relva
14. Parte inferior do depósito de relva x 2
15. Símbolos de advertência
16. Rótulo de Avaliação do Produto
17. Manual de Instruções

PL - ZAWARTOSC KARTONU

1. Górny uchwyt
2. Dolny uchwyt x 2
3. Zaslepka dolnego uchwytu x 2
4. Zaczep kabla x 2
5. Rączka Zacisku Krzywkowego x 4
6. Nakrętka z Otworem Gwintowanym x 4
7. Podkładka x 4
8. Śruba x 2
9. Blok Obrotowy x 2
10. Sprężyna x 2
11. Zaslepka do Mulczowania
12. Uchwyt kosza na trawę
13. Górna część pojemnika na trawę
14. Dolna część pojemnika na trawę x 2
15. Symbole Ostrzegawcze
16. Tabliczka znamionowa
17. Instrukcja Obsługi

H - TARTALOMJEGYZÉK

1. Felső tolókar
2. Alsó tolókar 2x
3. Az alsó kar dugója x 2
4. Kábelrögzítő 2x
5. Bűtykös zár x 4
6. Hengeres anya x 4
7. Alátét 4x
8. Csavar 2x
9. Forgócsap x 2
10. Rugó x 2
11. Védő dugó
12. Függyítő fogantyú
13. Függyítő felső része
14. Függyítő alsó része x 2
15. Figyelmeztető jelek
16. Termékinformációs címke
17. Kezelési útmutató

CZ - POPIS STROJE

1. Horní rukojeť
2. Spodní rukojeť x 2
3. Krytka dolní části držadla x 2
4. Úchytka kabelu x 2
5. Vačková páka x 4
6. Válcová natičie x 4
7. Podložka x 4
8. Šroub x 2
9. Otočný blok x 2
10. Pružina x 2
11. Mulčovací zátka
12. Rukojeť sběracího koše
13. Horní část koše na trávu
14. Dolní část koše na trávu x 2
15. Výstražné značky
16. Výrobní štítek
17. Návod k používání

SK - OBSAH

1. Vrchná rukoväť
2. Spodná rukoväť x 2
3. Príchytky na dolnej rúčke x 2
4. Svorka na kábel x 2
5. Vačkový zámok x 4
6. Válcová matica x 4
7. Podložka x 4
8. Skrutka x 2
9. Čepový blok x 2
10. Pružina x 2
11. Prípojka s krytom
12. Rúčka kontajnéra na trávu
13. Vrchná časť schránky na trávu
14. Spodná časť schránky na trávu x 2
15. Varovné symboly
16. Prístrojový štítok
17. Prírúčka

GR - ΠΕΡΙΕΧΟΜΕΝΑ

1. Κάτω λαβή
2. Επάνω λαβή x 2
3. Τάπα κάτω λαβής x 2
4. Κλιπ καλωδίου x 2
5. Ασφάλεια εκκέντρου x 4
6. Παξιμάδι κυλίνδρου x 4
7. Ροδέλα x 4
8. Μπουλόνι x 2
9. Μπλοκ στροφέα x 2
10. Ελατήριο x 2
11. Τάπα τεμαχισμού
12. Λαβή καλάθιού κομμένου γρασιδιού
13. Επάνω μέρος καλάθιού κομμένου γρασιδιού
14. Κάτω μέρος καλάθιού κομμένου γρασιδιού x 2
15. Προειδοποιητικά σύμβολα
16. Ετικέτα Κατάταξης Προϊόντος
17. Εγχειρίδιο Οδηγίας

RUS - СОДЕРЖИМОЕ:

1. Верхняя часть рукоятки
2. Нижняя часть рукоятки x 2
3. Заглушка нижней секции рукоятки x 2
4. Зажим кабеля x 2
5. Эксцентриковый зажим x 4
6. Цилиндрическая гайка x 4
7. Шайба x 4
8. Болт x 2
9. Поворотная планка x 2
10. Пружина x 2
11. Вставка для мульчирования
12. Ручка сборника срезанной травы
13. Верхняя часть сборника срезанной травы
14. Нижняя часть сборника срезанной травы x 2
15. Предупреждающие символы
16. Этикетка с характеристиками изделия
17. Руководство по использованию

SLO - VSEBINA

1. Zgornje držalo
2. Spodnje držalo x 2
3. Čep za spodnjo ročico x 2
4. Sponka za kabel x 2
5. Zaklep odmikala x 4
6. Navrtka x 4
7. Podložka x 4
8. Vijak x 2
9. Zaklep vrtenja x 2
10. Vzme x 2t
11. Pripomoček za mulčenje
12. Ročka zbiralnika za travo
13. Zgornji del zbiralnika trave
14. Spodnji del zbiralnika traves x 2
15. Opozorilni simboli
16. Tipna tablica
17. Priročnik

HR - SADRŽAJ

1. Gornja drška
2. Donja ručica x 2
3. Štitnik donje ručice x 2
4. Kvačica za kabel x 2
5. Zupčasti vijak x 4
6. Cilindrična matica x 4
7. Brtva x 4
8. Vijak s maticom x 2
9. Blokator osovine x 2
10. Opruga x 2
11. Uredaj za mljevenje
12. Ručka kutije za travu
13. Gornji dio kutije za travu
14. Donji dio kutije za travu x 2
15. Simboli upozorenja
16. Etiketa s ocjenom proizvođača
17. Priručnik s uputama

UA - ЗМІСТ

- Верхня ручка
- Нижня ручка
- Пробка нижньої ручки x 2
- Скоба для кабелю x2
- Фіксатор x 4
- Циліндрична гайка x 4
- Мийка x 4
- Болт x 2
- Поворотний блок x 2
- Пружина x 2
- Контейнер для подрібнення
- Ручка ємності для трави
- Верхня ємність для трави
- Нижня ємність для трави x 2
- Символи-попередження
- Маркування номінальної характеристики виробу
- Інструкція з експлуатації

RO - COMPONENTELE

- Măner superior
- 2 x mâner inferior
- Dop pentru mânerul inferior x 2
- 2 x coliere pentru cablu
- Știft de blocare x 4
- Piuliță tambur x 4
- 4 x șaibe
- 2 x șuruburi
- Articulație cu pivot x 2
- Arc x 2
- Opritor pentru repunerea ierbii tunse
- Mănerul cutiei pentru iarbă
- Partea superioară a cutiei pentru iarbă
- 2 x partea inferioară a cutiei pentru iarbă
- Simboluri de avertisment
- Plăcuța de identificare a produsului
- Manual de instrucțiuni

TR - İÇİNDEKİLER

- Alt Kol
- Üst Kol x 2
- Alt kol tapası x 2
- Kablo klipsi x2
- Kam Kilidi x 4
- Kovan Somunu x 4
- Contası x 4
- Civatası x 2
- Pivot Bloğu x 2
- Yay x 2
- Saman Örtüsü Fişi
- Çim Kutusu Tutamağı
- Çim Kutusu Üst Kısım
- Çim Kutusu Alt Kısım x 2
- Uyarı Sembolleri
- Ürün Sınıflandırma Etiketi
- Talimat Elkitabı

BG - СЪДЪРЖАНИЕ

- Горна дръжка
- Долна дръжка
- Капачка на долната дръжка x 2
- Кабелна клемма x2
- Палец за затягане x 4
- Цилиндрична гайка x 4
- Шайба x 4
- Болт? x 2
- Шарнирен Блок x 2
- Пружина x 2
- Накрайник за торене
- Дръжка на кош за трева
- Горна част на кош за трева
- Долна част на кош за трева x 2
- Предупредителни символи
- Табелка с данни за продукт
- Инструкции за употреба

EST - OSAD

- Ülemine käepide
- Alumise käepide x 2
- Alumise käepideme kork x 2
- Juhtme klamber x2
- Nukilukk x 4
- Torummutter x 4
- Seib x4
- Polt x2

- Liigendplokk x 2
- Vedru x 2
- Multšiprunt
- Rohukasti käepide
- Rohukasti pealis
- Rohukasti alus x 2
- Hoiautumärgid
- Toote kasutusvõimsuse tabel
- Kasutusjuhend

LT - SUDEDAMOSIOS DALYS

- Viršutinė rankena
- Apatinė rankena x 2
- Apatinės rankenėlės kaištis x 2
- Laido segtukas x2
- Galinis užraktas x 4
- Cilindro varžlė x 4
- Poveržlė x4
- Varžtas x2
- Ašies antgalis x 2
- Spyruoklė x 2
- Mulčiavimo kaištis
- Žolės dėžės rankena
- Žolės dėžės viršutinė dalis
- Žolės dėžės apatinė dalis x 2
- Išpėjamieji ženklai
- Gaminio klasės etiketė
- Instrukcija

LV - IERPAKOJUMA SATURS

- Augšējais rokturis
- Apakšējais rokturis x 2
- Apakšējā roktura tapa x 2
- Kabeļa skava x 2
- Ekscentra slēdzis x 4
- Cilindriskais uzgrieznis x 4
- Blīvējums x4
- Skrūve x4
- Sarnīrs x 2
- Atspere x 2
- Mulčēšanas ieliktnis
- Zāles savācējgroza rokturis
- Zāles savācējgroza augšdaļa
- Zāles savācējgroza apakšdaļa x 2
- Bridinājuma simboli
- Izstrādājuma datu uzlīme
- Lietošanas rokasgrāmata

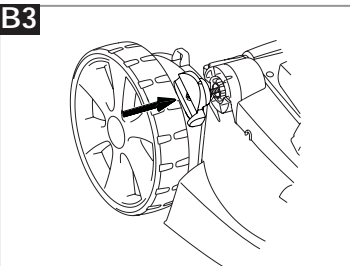
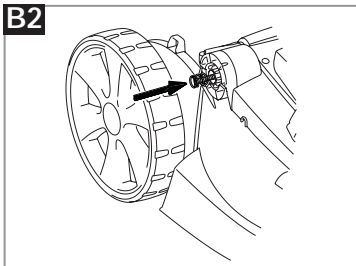
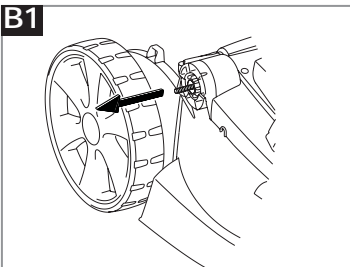
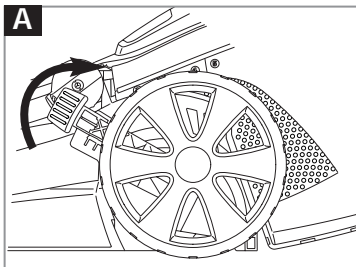

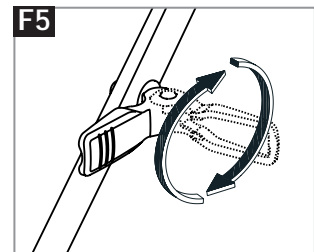
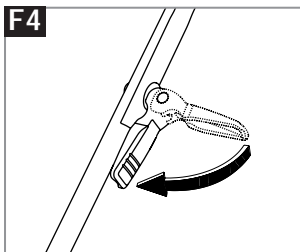
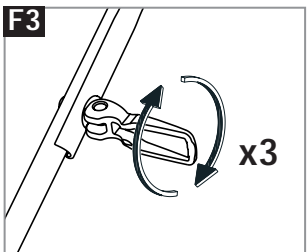
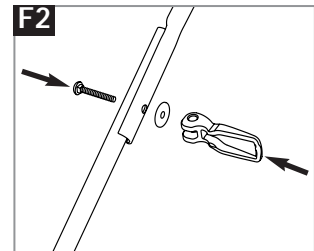
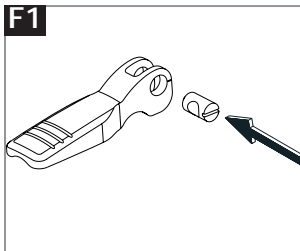
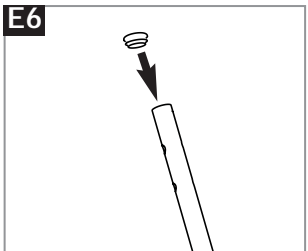
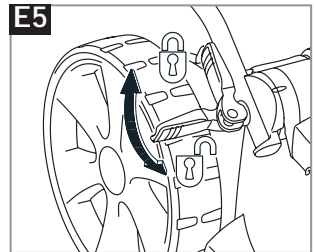
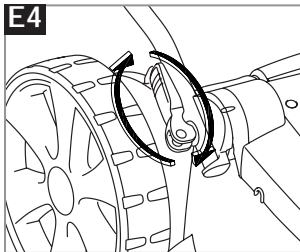
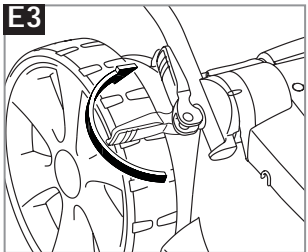
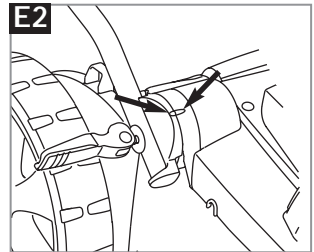
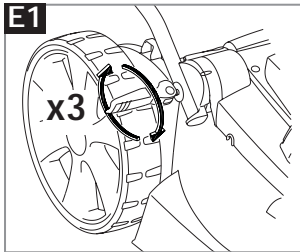
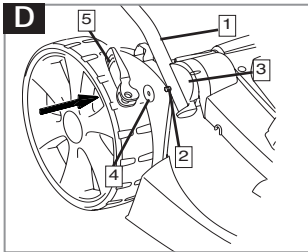
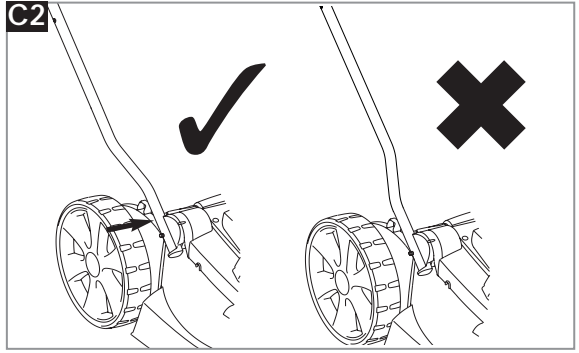
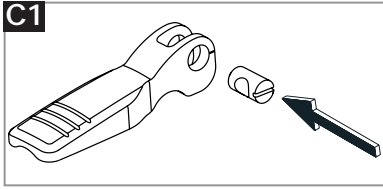

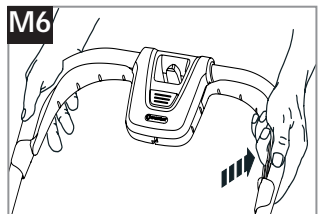
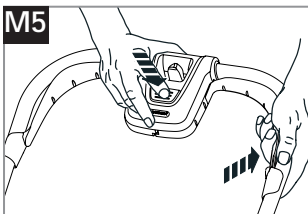
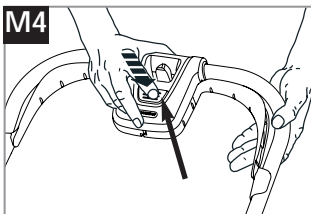
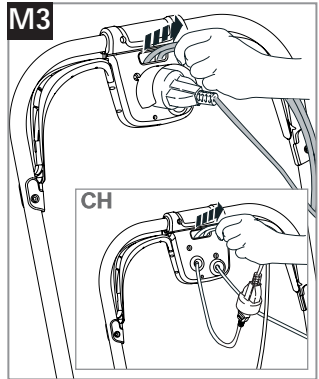
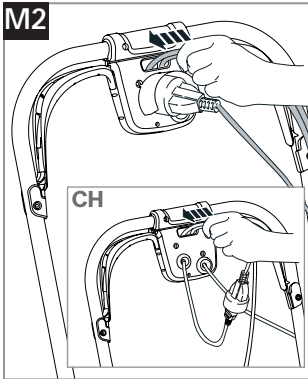
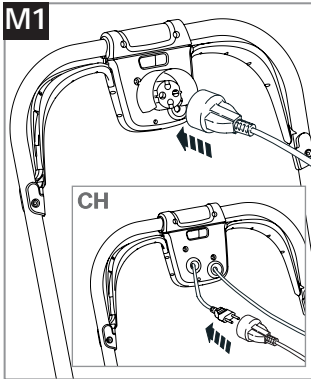
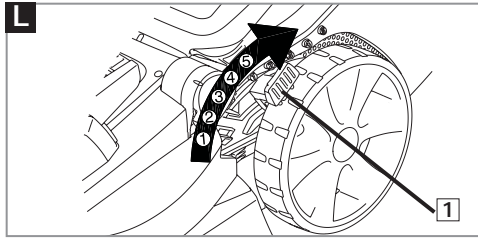
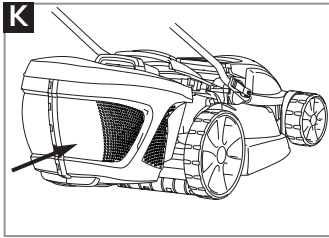
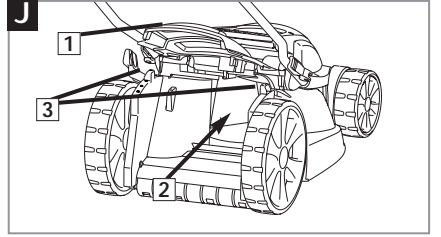
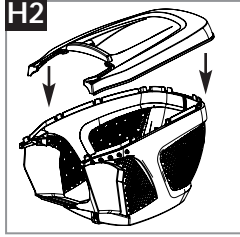
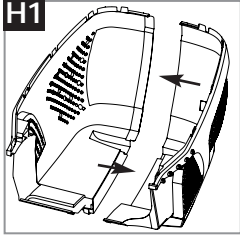
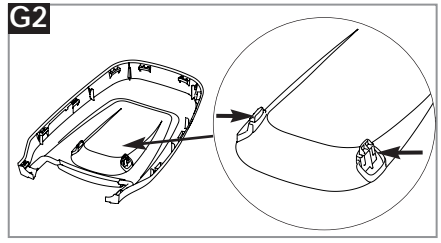
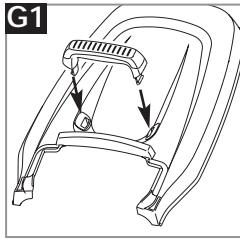
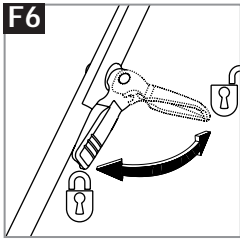

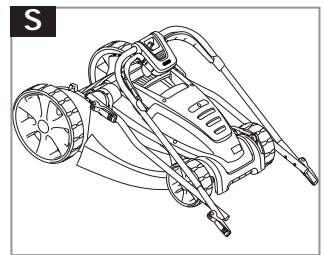
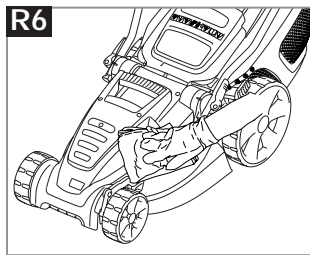
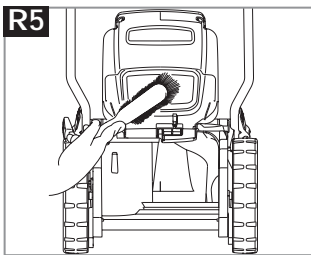
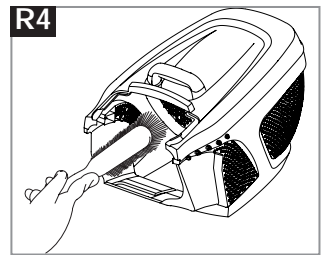
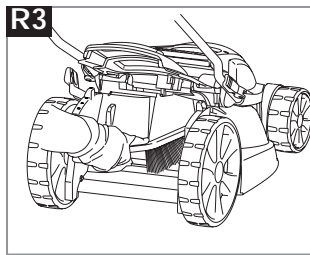
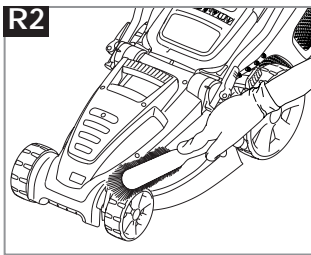
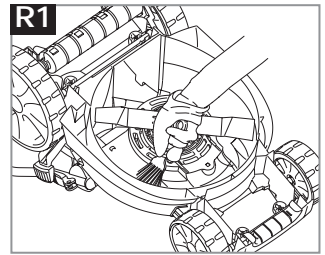
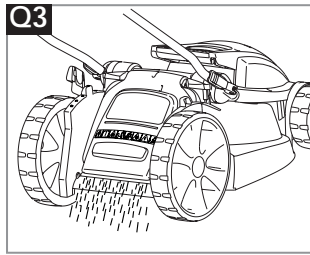
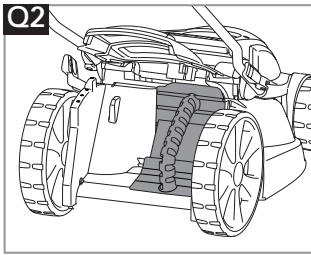
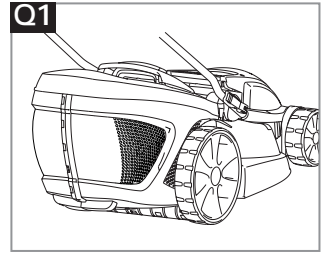
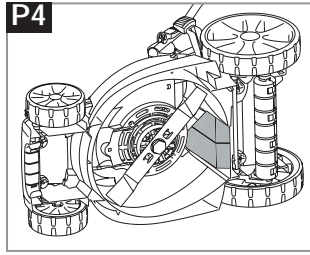
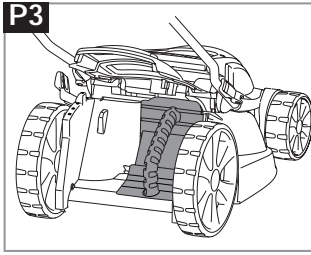
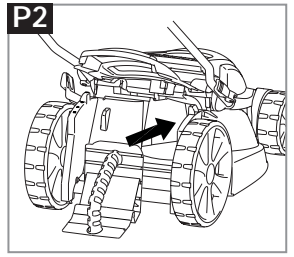
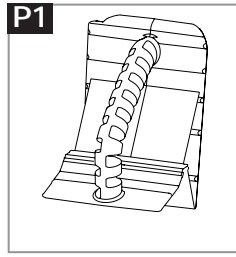
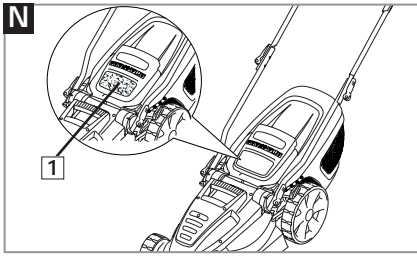

D	Zur Reinigung KEINE Flüssigkeiten verwenden.	E	NO utilice líquidos para la limpieza.	UA	Для очищення НЕ ВИКОРИСТОВУЙТЕ рідину.
GB	DO NOT use liquids for cleaning.	P	NÃO use líquidos para limpar.	RO	NU utilizați pentru curățire lichide.
F	NE PAS utiliser de produit liquide pour le nettoyage.	PL	NIE używać płynów do czyszczenia.	TR	Temizleme için sıvılar KULLANMAYIN.
NL	Voor het reinigen NOOIT vloeistoffen gebruiken.	H	NE használjon folyadékot tisztításra.	BG	НЕ използвайте течности за почистване
S	ANVÄND INTE vätskor för rengöring.	CZ	K čištění NEPOUŽÍVEJTE kapaliny.	EST	ÄRGE kasutage puhastamiseks vedelikke.
DK	BRUG IKKE væske til rengøring.	SK	NEPOUŽÍVAJTE na čistenie tekuté materiály.	LT	Neaudokite skysčių valymui.
N	Flytende midler MÅ IKKE brukes til rengjøring.	GR	ΜΗΝ καθαρίζετε με υγρά.	LV	Tīršanai NEIZMANTOJIET šķidrums.
FIN	ÄLÄ käytä nesteitä puhdistamiseen.	RUS	НЕ используйте жидкости для очистки.		
I	NON usare liquidi per la pulizia.	SLO	NE uporabljajte raznih tekočin za čiščenje.		
		HR	NEMOJTE koristiti tekućine za čišćenje.		

D	Reparaturen dürfen nur von GARDENA Servicestellen oder von GARDENA autorisierten Fachhändlern durchgeführt werden.	E	Las reparaciones solo pueden hacerlas los centros de servicio de GARDENA o los distribuidores autorizados por GARDENA.	HR	Popravak mogu izvršiti GARDENA servisni centri ili prodajna mjesta koje je GARDENA za to ovlastila.
GB	Repairs may only be carried out by GARDENA service centres or dealers authorised by GARDENA.	P	As reparações podem não ser feitas nos centros de serviço ou concessionários autorizados da GARDENA.	UA	Ремонт може здійснюватися винятково в сервісних центрах GARDENA, або дилерами, які авторизовані GARDENA.
F	Pour des raisons de sécurité, les réparations ne doivent être effectuées que par le Service Après-Vente de GARDENA France ou l'un des Centres SAV agréés GARDENA.	PL	Naprawy mogą być wykonywane tylko w placówkach serwisowych GARDENA lub u dealerów autoryzowanych przez GARDENA.	RO	Reparațiile se vor efectua doar de către centrele de service GARDENA sau de către dealerii autorizati de către GARDENA.
NL	Reparaties mogen alleen door de GARDENA technische dienst of door GARDENA geautoriseerde vakhandels uitgevoerd worden.	H	Javítást csak a GARDENA szervizközpontok vagy a GARDENA által meghatalmazott márkakereskedők végezhetnek.	TR	Onarım çalışmaları, yalnızca GARDENA servis merkezleri veya GARDENA tarafından onaylanan satıcılar tarafından yürütülebilir.
S	Reparationer får endast utföras av GARDENA service eller av återförsäljares service auktoriserad av GARDENA.	CZ	Opravy mohou provádět pouze servisní střediska firmy GARDENA nebo prodejci schválení firmou GARDENA.	BG	Ремонти могат да се извършват единствено от центрoвете по поддръжката на GARDENA или изпълномощни от нея представители.
DK	Reparationer må kun udføres af GARDENA service centre eller forhandlere, der er autoriseret af GARDENA.	SK	Opravy môžu byť prevedené iba v servisnom stredisku GARDENA alebo u predajcov autorizovaných spoločnosťou GARDENA.	EST	Parandustöid tohivad teha vaid GARDENA teeninduskeskused või GARDENA volitatud edasimüüjad.
N	Reparasjon vil muligens kun bli utført av GARDENAs servicesenter eller autoriserte GARDENA-forhandlere.	GR	Οι επισκευές διεξάγονται μόνο από τα κέντρα σέρβις της GARDENA ή από εξουσιοδοτημένους αντιπροσώπους της GARDENA.	LT	Remontuoti prietaisą galima tik GARDENA techninės priežiūros centruose arba pas įgaliotą GARDENA atstovą.
FIN	Korjaukset voidaan ainoastaan suorittaa GARDENA'n huoltokeskusten tai GARDENA'n valtuuttamien myyjien toimesta.	RUS	Починка устройства может быть выполнена только сервис-центрами компании GARDENA или официальными посредниками GARDENA.	LV	Remontu drīkst veikt tikai GARDENA klientu apkalpošanas centri vai GARDENA apstiprināti tirgotāji.
I	Le riparazioni possono essere eseguite solo dai centri assistenza GARDENA o da personale specializzato autorizzato GARDENA.	SLO	Popravila lahko opravijo samo servisni centri GARDENA ali prodajalci, ki jih je pooblastilo podjetje GARDENA.		

Safety



If not used properly this product can be dangerous! This product can cause serious injury to the operator and others, the warnings and safety instructions must be followed to ensure reasonable safety and efficiency in using this product. The operator is responsible for following the warning and safety instructions in this manual and on the product.

Explanation of Symbols on the product



Warning



Read the user instructions carefully to make sure you understand all the controls and what they do.



Always keep the product on the ground when operating. Tilting or lifting the product may cause stones to be thrown out.



Keep bystanders away. Do not operate whilst people especially children or pets are in the area.



Beware of sharp blades - remove plug from mains before maintenance or if cable is damaged.



Blades continue to rotate after the machine is switched off.



Keep the cable supply away from the cutting means



General

- This product is not intended for use by persons (including children) with reduced physical, sensory or mental capabilities, or lack of experience and knowledge, unless they have been given supervision or instruction concerning the use of the product by a person responsible for their safety. Children should be supervised to ensure that they do not play with the product. For safety reasons, children under the age of 16 or people who are not familiar with these operating instructions should not use this product.
- Only use the product in the manner and for the functions described in these instructions.
- Never operate the product when you are tired, ill or under the influence of alcohol, drugs or medicine.
- The operator or user is responsible for accidents or hazards occurring to other people or their property.

Electrical

- The use of a Residual Current Device (R.C.D.) with a tripping current of not more than 30mA is recommended. Even with a R.C.D. installed 100% safety cannot be guaranteed and safe working practice must be followed at all times. Check your R.C.D. every time you use it.
- Before use, examine cable for damage, replace it if there are signs of damage or ageing.
- Do not use the product if the electric cables are damaged or worn
- Immediately disconnect from the mains electricity supply if the cable is cut, or the insulation is damaged. Do not touch the electric cable until the electrical supply has been disconnected. Do not repair a cut or damaged cable. Replace it with a new one.
- Your extension cable must be uncoiled, coiled cables can overheat and reduce the efficiency of your mower.
- Keep cable away from product, always work away from the power point mowing up and down, never in circles.
- Do not pull cable around sharp objects.
- Always switch off at the mains before disconnecting any plug, cable connector or extension cable.
- Switch off, remove plug from mains and examine electric supply cable for damage or ageing before winding cable

- for storage. Do not repair a damaged cable, replace it with a new one. Use only genuine replacement cable.
- Always wind cable carefully, avoiding kinking.
- Never carry the product by the cable.
- Never pull on the cable to disconnect any of the plugs.
- Use only on AC mains supply voltage shown on the product rating label.
- Our products are double insulated to EN60335. Under no circumstances should an earth be connected to any part of the product.

Cables

If extension cables are used, these must comply with the minimum cross-sections in the table below:

Voltage	Cable length	Cross section
220-240V/ 50Hz	Up to 20 m	1.5 mm ²
220-240V/ 50Hz	20 - 50 m	2.5 mm ²

- Only use extension cables specifically designed for outdoor use.

Preparation

- While using your product always wear substantial footwear and long trousers.
- Make sure the lawn is clear of sticks, stones, bones, wire and debris; they could be thrown by the blade.
- Before using the machine and after any impact, check for signs of wear or damage and repair as necessary.
- Replace worn or damaged blades together with their fixings in sets to preserve balance.

Use

- Use the product only in daylight or good artificial light.
- Avoid operating your product in wet grass, where feasible.
- Take care in wet grass, you may lose your footing.
- On slopes, be extra careful of your footing and wear non-slip footwear.
- Operate your product across the face of slopes, never up and down.
- Exercise extreme caution when changing direction on slopes. Walk never run.
- Make sure you always take up a safe and stable stance whilst working, especially on slopes. Do not use the mower close to swimming pools or garden ponds.
- Do not walk backwards when operating, you could trip.
- Never cut grass by pulling the product towards you.
- Switch off before pushing the product over surfaces other than grass.
- Never operate the product with damaged guards or without guards in place.
- Keep hands and feet away from the cutting means at all times and especially when switching on the motor.
- Do not tilt product when the motor is running.
- Do not put hands near the grass discharge chute.
- Never pick up or carry a product when it is operating or still connected to the mains supply.
- Remove the plug from the mains :
 - before leaving the product unattended for any period;
 - before clearing a blockage;
 - before checking, cleaning or working on the appliance;
 - if you hit an object. Do not use your product until you are sure that the entire product is in a safe operating condition.;
 - if the product starts to vibrate abnormally. Check immediately. Excessive vibration can cause injury.

Maintenance and storage

- Caution: Do not touch rotating blade(s)
- Keep all nuts, bolts and screws tight to be sure the product is in safe working condition.
- Check the grassbox frequently for wear or deterioration.
- Replace worn or damaged parts for safety.
- Only use the replacement parts specified for this product.
- Be careful during adjustment of the product to prevent entrapment of the fingers between moving blades and fixed parts of the machine.
- Store in a cool dry place and out of reach of children. Do not store outdoors.

Where to Use Your GARDENA PowerMax 36 E/42 E Mower

The GARDENA mower is designed for cutting lawns in and around the garden.

Do not use the mower on a slope steeper than 20° maximum.

To prevent injury, the mower must not be used for trimming bushes, hedges, shrubs, for cutting and pruning of climbers or grass on roofs or in balcony boxes. In addition, the mower must not be used for chopping up branches, twigs or for levelling irregularities in the soil.

IMPORTANT INFORMATION

When received from the Manufacturer, the wheels are in a raised position. **Do not switch on the product** before removing from the raised position into position 5. (See fig A)

Assembly of Lower Handles to Lawnmower

1. Pull the lower handle bolt until it locks into position as illustrated in fig B1.
2. Place the Spring over the Bolt (B2)
3. Insert the Pivot Block on to the Bolt (B3)
Repeat for the other side.
4. Insert the Barrel Nut into the Cam Lock as illustrated in fig C1.
5. Ensuring the Lower Handle is in the correct position (C2), insert the Lower Handle (D1) on to the Bolt (D2) until it is firmly fitted into the Pivot Block (D3).
6. Place the Washer (D4) and Cam Lock (D5) on to the Bolt (D2) and turn the Cam Lock 3 times clockwise, as illustrated in fig E1.
7. Ensuring the raised markings on the Cam Lock and the deck are aligned (E2), fold down the Cam Lock towards the Handle as illustrated in fig E3, and continue to turn clockwise (E4) until tightened.
8. The Cam Lock can be unlocked and locked as illustrated in fig E5.
Repeat for the other side.
9. Insert the two Lower handle plugs into the top of each of the Lower handles (E6).

Assembly of Upper Handles to Lower Handles

1. Insert the Barrel Nut into the Cam Lock as illustrated in fig F1.
2. Attach the Upper Handle to the Lower Handle with the Round Headed Bolt, Washer and Cam Lock as illustrated in fig F2
3. Turn the Cam Lock 3 times clockwise, as illustrated in fig F3.
4. Fold down the Cam Lock towards the Handle as illustrated in fig F4, and continue to turn clockwise (F5) until tightened.
5. The Cam Lock can be unlocked and locked as illustrated in fig F6.
Repeat for the other side.

Grassbox Assembly

Grassbox Handle Assembly

1. Locate the grassbox handle into the slots in the grassbox upper and push until it clicks into position. (G1)
2. Looking at the underside of the lid (G2), ensure the clips of the grassbox handle are securely located.

Grassbox Assembly

1. Locate the the grassbox halves together by aligning the clips. Ensure all clips are correctly located before clicking into position. (H1)
2. Locate the grassbox lid onto the assemble grassbox by aligning the clips. Ensure all clips are correctly located before clicking into position (H2)

Fitting Fully Assembled Grassbox to Lawnmower.

1. Lift safety flap (J1)
2. Make sure the discharge chute is clean and free

from debris (J2)

3. Locate fully assembled grassbox onto 2 location points (J3) at the rear of the deck as illustrated in pic. K
4. Locate safety flap onto the top of the grassbox. Ensure the grassbox is securely located.
 - **IMPORTANT ! AFTER FITTING ENSURE NO GAP REMAINS BETWEEN THE SAFETY FLAP AND THE GRASSBOX.**
 - Removal is the reverse procedure.
 - For larger areas of grass where grass collection is not required you can use your lawnmower without the grassbox. Ensure the Safety Flap is fully closed. The design of the safety flap permits the cut grass to be discharged downward behind the machine.

Cutting Height Adjustment

- Height of cut is adjusted by raising or lowering the wheels using the height adjustment lever (L1)
- There are five heights of cut on this product (20 - 60 mm).

- **NOTE**
A medium height of cut is recommended for most lawns. The quality of your lawn will suffer and collection will be poor if you cut too low.

Starting and Stopping

To Start your Lawnmower

1. Attach the extension cable to the back of the switchbox.(M1)
2. Form a loop in the cable and push the loop through the slot. (M2)
3. To secure, position the loop over the hook and pull the cable back through the slot (M3).
4. Connect the plug to the mains and switch on.
The switchbox is provided with a lock-off button (M4) to prevent accidental starting.
6. Press and hold the lock-off button (M4) on the

switchbox, then squeeze one of the Start/Stop levers towards the upper handle (M5).

7. Continue to squeeze the start/stop lever towards the upper handle and release the lock-off button (M6).
- **NOTE - There are two start/stop levers fitted. Either one can be used for starting the lawnmower.**
- **IMPORTANT - Do not use the start/stop levers intermittently**

To Stop your Lawnmower

1. Release the pressure on the Start/Stop lever.

CH (Schweiz)

To ensure you have a secure connection between the lawnmower and the extension cable we strongly recommend you use the following method of attaching the cable:

1. Plug the short connection lead into the socket of the extension cable. (M1).
2. Form a loop in the end of the extension cable near to

the socket and secure this in the strain relief feature at the top of the switchbox (M2, M3) This will cause the socket to hang in a downward direction.

If the short connection lead is damaged, it must be replaced by the manufacturer, its service agent or similarly qualified persons in order to avoid a hazard.

Grassbox Full Window

- As the grassbox fills up, grass will be visible through the window (N1).
- When the window/grassbox is full it is time to empty the grassbox.

Mulching Plug

Using as a mulcher

1. Your lawnmower is supplied with a mulching plug. (P1)
2. Stop your lawnmower as described in **Starting and Stopping**.
3. Lift safety flap and insert the mulching plug into rear

discharge chute, (P2) ensuring it is securely fitted. (P3)

4. The mulching plug prevents grass from being collected by blocking the collection chute on the underside of the deck. (P4)

How to Mow

Your product can be used to cut grass using the following methods:-

1. **Grassbox Fitted:-** grass is collected effectively and compacted into the grassbox. (Q1)
2. **Mulch Plug Fitted:-** grass cuttings are finely chopped to return nutrients to your lawn (Q2).
3. **Rear Discharge:-** Effectively cuts long grass with no need to empty the grassbox (Q3)

How to Mow

1. Start mowing the edge of the lawn nearest to the power point so the cable is laid out on the lawn you

have already cut.

2. Mow twice a week during the growing season, your lawn will suffer if more than a third of its length is cut at one time.

Do Not Overload Your Mower

Mowing long thick grass may cause the motor speed to drop, you will hear a change in the motor sound. If the motor speed drops you may overload your lawnmower which may cause damage. When mowing in long thick grass a first cut with the cutting height set higher will help reduce the load. See Cutting Height Adjustment.

Caring for your Lawnmower

Cleaning

• **USE GLOVES**

• **IMPORTANT:-** It is very important that you keep your lawnmower clean. Grass clippings left in any of the air intakes or under the deck could become a potential fire hazard.

1. Remove grass from under the deck with brush. (R1)
2. Using a soft brush - remove grass clippings from all air intakes (R2), the discharge chute (R3) and the grass box (R4).
3. Using a soft brush, remove grass clippings from the vision window (R5).
4. Wipe over the surface of your lawnmower with a dry cloth (R6).

• **IMPORTANT:-** Never use water for cleaning your lawnmower. Do not clean with chemicals, including petrol, or solvents - some can destroy critical plastic parts.

Storing your Lawnmower:

- Loosen the Cam Locks to enable the handles to be folded over the product (S).
- Store in a dry place where your lawnmower is protected from damage

At the End of the Mowing Season

1. Replace bolts, nuts or screws, if necessary.
2. Clean your lawnmower thoroughly.
3. Make sure that the electric cable is stored correctly to prevent damage.

Fault Finding Hints

Fails to Operate

1. Is the correct Starting procedure being followed?
See "To Start your Lawnmower"
2. Is the Power Turned On?
3. Check the fuse in the plug, if blown replace.
4. Fuse continues to blow?

Immediately disconnect from the mains electricity supply and consult your GARDENA Service Centre.

Poor Grass Collection

1. Disconnect from the mains electricity supply.
2. Clean the outside of the air intakes, the discharge chute and the underside of the deck.
3. Raise to a higher height of cut. See Cutting Height Adjustment.
4. If poor collection persists.
Immediately disconnect from the mains electricity supply and consult your GARDENA Service Centre.

Excessive Vibration

1. Disconnect from the mains electricity supply.
2. Check that the blade is fitted correctly?
3. If the blade is damaged or worn, replace it with a new one.
4. If vibration persists?

Immediately disconnect from the mains electricity supply and consult your GARDENA Service Centre. Lawnmower becomes heavy to push

1. Disconnect from the mains electricity supply.
2. In long grass or uneven ground, the height of cut should be raised to a higher position. See Cutting Height Adjustment.
3. Check that the wheels and rollers can rotate freely.
4. If problem persists?
Immediately disconnect from the mains electricity supply and consult your GARDENA Service Centre.

Environmental Information

Husqvarna UK Ltd. products are manufactured under an Environmental Management System (ISO 14001) using, where practical, components manufactured in the most environmentally responsible manner, according to company procedures, and with the potential for recycling at the end of the products' life.

- Packaging is recyclable and plastic components have been labelled (where practical) for categorised recycling.
- Awareness of the environment must be considered when disposing of 'end-of-life' product.
- If necessary, contact your local authority for disposal information.

The symbol  on the product or on its packaging indicates that this product may not be treated as household waste. Instead it shall be handed over to the applicable collection point for the recycling of electrical and electronic equipment. By ensuring this product is disposed of correctly, you will help prevent potential negative consequences for the environment and human health, which could otherwise be caused by inappropriate waste handling of this product. For more detailed information about recycling of this product, please contact your local council office, your household waste disposal service or the shop where you purchased the product.

Warranty / Service

GARDENA guarantees this product for 2 years (starting from the date of purchase). This guarantee covers all serious defects of the unit that can be proved to be material or manufacturing faults.

Under warranty we will either replace the unit or repair it free of charge if the following conditions apply:

- The unit must have been handled properly and in keeping with the requirements of the operating instructions.
- Neither the purchaser or a non-authorized third party have attempted to repair the unit.

The blade is a wearing part and is not covered by the guarantee.

This manufacturer's guarantee does not affect the user's existing warranty claims against the dealer/seller.

If a fault occurs with your Powermax 36 E/42 E Lawnmower, please return the faulty unit together with a copy of the receipt and a description of the fault, with postage paid to one of the GARDENA Service Centres listed on the back of these operating instructions.

Service Recommendations

- Your product is uniquely identified by a silver product rating label.
- We strongly recommend that your product is serviced at least every twelve months.

EU Certificate of Conformity

The undersigned GARDENA Manufacturing GmbH, Hans-Lorenser-Str. 40, D-89079 Ulm, hereby certifies that, when leaving our factory, the units indicated below are in accordance with the harmonised EU guidelines, EU standards of safety and product specific standards. This certificate becomes void if the units are modified without our approval.

Description of Unit.....Electric Lawnmower

Type.....36 E, 42 E

Year of CE marking.....2008

EU Directives:

98/37/EC, 2006/42/EC, 2004/108/EC, 2000/14/EC, 2006/95/EC

Harmonised EN:

EN60335-1, EN60335-2-77, EN836, EN ISO 12100-1, EN ISO 12100-2

Working area related emission characteristic **Level** L_{pA} according to EN836 given in the table.

Vibrations **Value** a_{vhw} according to EN836 given in the table.

The Noise Level L_{WA} values according to 2000/14/EC are given in the table.

Conformity Assessment Procedure.....Annex VI

Notified Body.....Intertek, Cleeve Road
Leatherhead, Surrey
KT22 7SB, England

Ulm 01/10/2008

Peter Lameli

Technical Dept. Manager



Type	36 E	42 E
Width of Cut (cm)	36	42
Speed of rotation cutting device (rpm)	3.850	3.600
Power (W)	1500	1700
Measured Sound Power L _{WA} (dB(A))	95	95
Guaranteed Sound Power L _{WA} (dB(A))	96	96
Level L _{pA} (dB(A))	80.4	84.9
Value a _{vhw} (m/s ²)	1.56	1.53
Weight (Kg)	13.5	13.9

Deutschland / Germany

GARDENA
Manufacturing GmbH
Central Service
Hans-Lorenser-Straße 40
D-89079 Ulm
Produktfragen:
(+49) 731 490-123
Reparaturen:
(+49) 731 490-290
service@gardena.com

Argentina

Husqvarna Argentina S.A.
Vera 745
(C1414AOO) Buenos Aires
Phone: (+54) 11 4858-5000
diego.poggi@ar.husqvarna.com

Australia

Husqvarna Australia Pty. Ltd.
Locked Bag 18
Gosford NSW 2250
Phone: (+61) (0) 2 4372 1500
customer.service@
husqvarna.com.au

Austria / Österreich

Husqvarna Austria GmbH
Consumer Products
Industriezeile 36
4010 Linz
Tel.: (+43) 732 77 01 01 - 90
consumer.service@
husqvarna.at

Belgium

GARDENA Belgium NV/SA
Sterrebeekstraat 163
1930 Zaventem
Phone: (+32) 2 7 20 92 12
Mail: info@gardena.be

Brazil

Palash Comércio e
Importação Ltda.
Rua São João do Araguaia, 338
- Jardim Califórnia -
Barueri - SP - Brasil -
CEP 06409-060
Phone: (+55) 11 4198-9777
eduardo@palash.com.br

Bulgaria

Хускварна България ЕООД
1799 София
Бул. „Андрей Ляпчев“ № 72
Тел.: (+359) 2 80 99 424
www.husqvarna.bg

Canada / USA

GARDENA Canada Ltd.
100 Summerlea Road
Brampton, Ontario L6T 4X3
Phone: (+1) 905 792 93 30
info@gardenacanada.com

Chile

Antonio Martinic y Cia Ltda.
Cassillas 272
Centro de Cassillas
Santiago de Chile
Phone: (+56) 2 20 10 708
garfar_cl@yahoo.com

Costa Rica

Compania Exim
Euroberoamericana S.A.
Los Colegios, Moravia,
200 metros al Sur del Colegio
Saint Francis - San José
Phone: (+506) 297 68 83
exim_euro@racsa.co.cr

Croatia

KLIS d.o.o.
Stanciceva 79
10419 Vukovina
Phone: (+385) 1 622 777 0
gardena@klis-trgovina.hr

Cyprus

FARMOKIPIKI LTD
P.O. Box 7098
74, Digeni Akritas Ave.
1641 Nicosia
Phone: (+357) 22 75 47 62
condam@spidernet.com.cy

Czech Republic

GARDENA spol. s r.o.
Tuřanka 115
627 00 Brno
Phone: (+542) 548 217 777
gardena@gardenabrno.cz

Denmark

GARDENA
Husqvarna Consumer Outdoor
Products
Salgsafdelning Danmark
Box 9003
S-200 39 Malmö
info@gardena.dk

Estonia

Husqvarna Eesti OÜ
Consumer Outdoor Products
Kesk tee 10, Aaviku küla
Rae vald, Harju maakond
75305
kontakt.etj@husqvarna.ee

Finland

Oy Husqvarna Ab
Consumer Outdoor Products
Lautatarhankatu 8 B / PL 3
00581 HELSINKI
info@gardena.fi

France

GARDENA France
Immeuble Exposit
9 - 11 allée des Pierres Mayettes
ZAC des Barbannières, B.P. 99
-F- 92232 GENNEVILLIERS
cedex
Tél. (+33) 01 40 85 30 40
service.consommateurs@
gardena.fr

Great Britain

Husqvarna UK Ltd
Preston Road
Aycliffe Industrial Park
Newton Aycliffe
County Durham
DL5 6UP
info.gardena@
husqvarna.co.uk

Greece

HUSQVARNA GREECE S.A.
Branch of Koropi
Ifestou 33A
Industrial Area Koropi
194 00 Athens - Greece
V.A.T. EL094094640
Phone: (+30) 210 66 20 225
info@husqvarna-consumer.gr

Hungary

Husqvarna
Magyarország Kft.
Ezred u. 1 - 3
1044 Budapest
Phone: (+36) 80 20 40 33
gardena@gardena.hu

Iceland

Ó. Johnson & Kaaber
Tunguhalsi 1
110 Reykjavik
oof@ojk.is

Ireland

Michael McLoughlin & Sons
Hardware Limited
Long Mile Road
Dublin 12

Italy

GARDENA Italia S.p.A.
Via Donizetti 22
20020 Lainate (Mi)
Phone: (+39) 02.93.94.79.1
info@gardenaitalia.it

Japan

KAKUICHI Co. Ltd.
Sumitomo Realty &
Development Kojimachi
BLDG., 8F, 5-1 Nibanncyo,
Chiyoda-ku, Tokyo 102-0084
Phone: (+81) 33 264 4721
m_ishihara@kaku-ichi.co.jp

Latvia

SIA „Husqvarna Latvija”
Consumer Outdoor Products
Bākūzu iela 6, Rīga, LV-1024
info@husqvarna.lv

Lithuania

UAB Husqvarna Lietuva
Consumer Outdoor Products
Atelities pl. 77C
LT-52104 Kaunas
centras@husqvarna.lt

Luxembourg

Magasins Jules Neuberg
39, rue Jacques Stas
Luxembourg-Gasperich 2549
Case Postale No. 12
Luxembourg 2010
Phone: (+352) 40 14 01
api@neuberg.lu

Netherlands

GARDENA Nederland B.V.
Postbus 50176
1305 AD ALMERE
Phone: (+31) 36 521 00 00
info@gardena.nl

Neth. Antilles

Jonka Enterprises N.V.
Sta. Rosa Weg 196
P.O. Box 8200, Curaçao
Phone: (+599) 9 767 66 55
pgm@jonka.com

New Zealand

Husqvarna New Zealand Ltd.
PO Box 76437
Manukau City 2241
Phone: (+64) 09 9202410

Norway

GARDENA
Husqvarna Consumer Outdoor
Products
Salgskontor Norge
Kleiverveien 6
1540 Vestby
info@gardena.no

Poland

Husqvarna Poland Spółka z o.o.
Oddział w Szymanowie
Szymanów 9 d
05-532 Baniocha
Phone: (+48) 22 727 56 90
gardena@gardena.pl

Portugal

GARDENA Portugal Lda.
Sintra Business Park
Edifício 1, Fração 0-G
2710-089 Sintra
Phone: (+351) 21 922 85 30
info@gardena.pt

Romania

MADEX INTERNATIONAL SRL
Soseaua Odail 117-123,
Sector 1,
București, RO 013603
Phone: (+40) 21 352 76 03
madex@ines.ro

Russia

ООО ГАРДЕНА РУС
123007, г. Москва
Хорошевское шоссе, д. 32А
Тел.: (+7) 495 380 31 92
info@gardena-rus.ru

Singapore

Hy-Ray PRIVATE LIMITED
40 Jalan Pemimpin
#02-08 Tat Ann Building
Singapore 577185
Phone: (+65) 6253 2277
shiyang@hyray.com.sg

Slovak Republic

GARDENA spol. s r.o.
Tuřanka 115
627 00 Brno
Phone: (+420) 548 217 777
gardena@gardenabrno.cz

Slovenia

GARDENA d.o.o.
Brodišče 15
1236 Trzin
Phone: (+386) 1 580 93 32
servis@gardena.si

South Africa

GARDENA
South Africa (Pty.) Ltd.
P.O. Box 11534
Vorna Valley 1686
Phone: (+27) 11 315 02 23
sales@gardena.co.za

Spain

GARDENA IBÉRICA S.L.U.
C/ Basauri, nº 6
La Florida
28023 Madrid
Phone: (+34) 91 708 05 00
atencioncliente@gardena.es

Sweden

GARDENA
Husqvarna Consumer Outdoor
Products
Försäljningskontor Sverige
Box 9003
200 39 Malmö
info@gardena.se

Switzerland / Schweiz

Husqvarna Schweiz AG
Consumer Products
Industriestrasse 10
5506 Mägenwil
Phone: (+41) (0) 848 800 464
info@gardena.ch

Turkey

GARDENA / Dost Diş Ticaret
Mümesillik A.Ş. Sanayi
Çad. Adil Sokak No.1
Kartal - İstanbul
Phone: (+90) 216 38 93 939
info@gardena-dost.com.tr

Ukraine / Україна

ТОВ «ГАРДЕНА УКРАЇНА»
Васильківська, 34, 204-Г
03022, Київ
Тел. (+38) 044 498 39 02
info@gardena.ua

4037-20.96.01 / 1008

© GARDENA
Manufacturing GmbH
D-89070 Ulm
http://www.gardena.com