

**Operator's manual**  
**324R<sub>X</sub>-series**

Please read the operator's manual carefully and make sure you understand the instructions before using the machine.

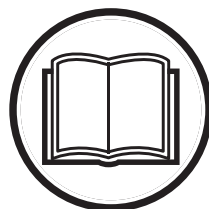

**English**

# KEY TO SYMBOLS

## Symbols

**WARNING!** Clearing saws, brushcutters and trimmers can be dangerous! Careless or incorrect use can result in serious or fatal injury to the operator or others. It is extremely important that you read and understand the contents of the operator's manual.



Please read the operator's manual carefully and make sure you understand the instructions before using the machine.



Always wear:

- A protective helmet where there is a risk of falling objects
- Approved hearing protection
- Approved eye protection



Max. speed of output shaft, rpm



This product is in accordance with applicable EC directives.



Watch out for thrown objects and ricochets.



The operator of the machine must ensure, while working, that no persons or animals come closer than 15 metres.



Machines fitted with saw blades or grass blades can be thrown violently to the side when the blade comes into contact with a fixed object. This is called blade thrust. The blade is capable of amputating an arm or leg. Always keep people and animals at least 15 metres from the machine.



Arrows which show limits for handle positioning.



Always wear approved protective gloves.



Wear sturdy, non-slip boots.



Only use non-metallic, flexible cutting attachments, i.e. trimmer heads with trimmer cord.



Noise emission to the environment according to the European Community's Directive. The machine's emission is specified in chapter Technical data and on label.



**Other symbols/decals on the machine refer to special certification requirements for certain markets.**

Switch off the engine by moving the stop switch to the STOP position before carrying out any checks or maintenance.

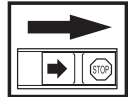

Always wear approved protective gloves.



Regular cleaning is required.

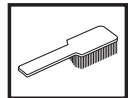

Visual check.



Approved eye protection must always be used.



# CONTENTS

## Contents

### KEY TO SYMBOLS

Symbols ..... 2

### CONTENTS

Contents ..... 3

Note the following before starting: ..... 3

### INTRODUCTION

Dear Customer, ..... 4

### WHAT IS WHAT?

What is what on the brush cutter? ..... 5

### GENERAL SAFETY PRECAUTIONS

Important ..... 6

Personal protective equipment ..... 6

Machine's safety equipment ..... 7

Cutting equipment ..... 10

### ASSEMBLY

Fitting the handlebar ..... 13

Transport position, handlebar ..... 13

Assembling the cutting equipment ..... 13

Fitting a blade guard, grass blade and grass cutter ..... 14

Fitting the blade guard and saw blade ..... 14

Fitting a trimmer guard and Superauto II 1" trimmer head ..... 15

Fitting other guards and cutting attachments ..... 15

Adjusting the harness and brush cutter ..... 16

Standard harness ..... 16

### FUEL HANDLING

Fuel handling ..... 17

Fuel ..... 17

### STARTING AND STOPPING

Check before starting ..... 19

Starting and stopping ..... 19

### WORKING TECHNIQUES

General working instructions ..... 21

### MAINTENANCE

Carburettor ..... 25

Muffler ..... 25

Cooling system ..... 26

Spark plug ..... 26

Air filter ..... 26

Maintenance schedule ..... 28

### TECHNICAL DATA

Technical data ..... 29

EC-declaration of conformity ..... 30

## Note the following before starting:

Please read the operator's manual carefully.



**WARNING! Long-term exposure to noise can result in permanent hearing impairment. So always use approved hearing protection.**



**WARNING! Under no circumstances may the design of the machine be modified without the permission of the manufacturer. Always use genuine accessories. Non-authorized modifications and/or accessories can result in serious personal injury or the death of the operator or others.**



**WARNING! A clearing saw, brushcutter or trimmer can be dangerous if used incorrectly or carelessly, and can cause serious or fatal injury to the operator or others. It is extremely important that you read and understand the contents of this operator's manual.**

---

# INTRODUCTION

---

## Dear Customer,

Congratulations on your choice to buy a Husqvarna product! Husqvarna is based on a tradition that dates back to 1689, when the Swedish King Karl XI ordered the construction of a factory on the banks of the Husqvarna River, for production of muskets. The location was logical, since water power was harnessed from the Husqvarna River to create the water-powered plant. During the more than 300 years of being, the Husqvarna factory has produced a lot of different products, from wood stoves to modern kitchen appliances, sewing machines, bicycles, motorcycles etc. In 1956, the first motor driven lawn mowers appeared, followed by chain saws in 1959, and it is within this area Husqvarna is working today.

Today Husqvarna is one of the leading manufacturers in the world of forest and garden products, with quality as our highest priority. The business concept is to develop, manufacture and market motor driven products for forestry and gardening as well as for building and construction industry. Husqvarna's aim is also to be in the front edge according to ergonomics, usability, security and environmental protection. That is the reason why we have developed many different features to provide our products within these areas.

We are convinced that you will appreciate with great satisfaction the quality and performance of our product for a very long time to come. The purchase of one of our products gives you access to professional help with repairs and service whenever this may be necessary. If the retailer who sells your machine is not one of our authorised dealers, ask for the address of your nearest service workshop.

It is our wish that you will be satisfied with your product and that it will be your companion for a long time. Think of this operator's manual as a valuable document. By following its' content (using, service, maintenance etc) the life span and the second-hand value of the machine can be extended. If you will sell this machine, make sure that the buyer will get the operator's manual.

Thank you for using a Husqvarna product.

Husqvarna AB has a policy of continuous product development and therefore reserves the right to modify the design and appearance of products without prior notice.

# WHAT IS WHAT?

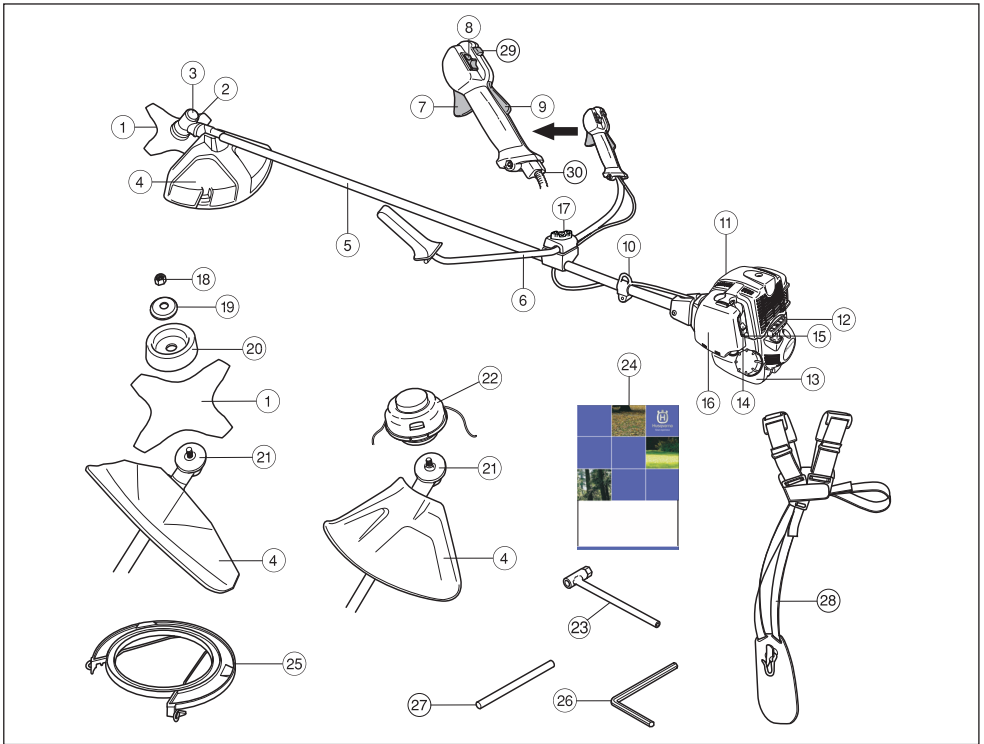

## What is what on the brush cutter?

- |                                 |                                |
|---------------------------------|--------------------------------|
| 1 Blade                         | 16 Air filter cover            |
| 2 Grease filler cap, bevel gear | 17 Handle adjustment           |
| 3 Bevel gear                    | 18 Locking nut                 |
| 4 Cutting attachment guard      | 19 Support cup                 |
| 5 Shaft                         | 20 Support cup                 |
| 6 Handlebar                     | 21 Drive disc                  |
| 7 Throttle control              | 22 Trimmer head                |
| 8 Stop switch                   | 23 Socket spanner              |
| 9 Throttle lockout              | 24 Operator's manual           |
| 10 Support eyes for harness     | 25 Transport guard             |
| 11 Cylinder cover               | 26 Allen key                   |
| 12 Starter handle               | 27 Locking pin                 |
| 13 Fuel tank                    | 28 Harness                     |
| 14 Choke control                | 29 Start throttle button       |
| 15 Air purge                    | 30 Adjusting the throttle wire |

# GENERAL SAFETY PRECAUTIONS

## Important

### IMPORTANT!

The machine is only designed for trimming grass, grass clearing and/or forestry clearing.

The only accessories you can operate with this engine unit are the cutting attachments we recommend in the chapter on Technical data.

Never use the machine if you are tired, if you have drunk alcohol, or if you are taking medication that could affect your vision, your judgement or your co-ordination.

Wear personal protective equipment. See instructions under the heading "Personal protective equipment".

Never use a machine that has been modified in any way from its original specification.

Never use a machine that is faulty. Carry out the checks, maintenance and service instructions described in this manual. Some maintenance and service measures must be carried out by trained and qualified specialists. See instructions under the heading Maintenance.

All covers, guards and handles must be fitted before starting. Ensure that the spark plug cap and ignition lead are undamaged to avoid the risk of electric shock.

The machine operator must ensure that no people or animals come closer than 15 metres while working. When several operators are working in the same area the safety distance should be at least twice the tree height and no less than 15 metres.



**WARNING! This machine produces an electromagnetic field during operation. This field may under some circumstances interfere with active or passive medical implants. To reduce the risk of serious or fatal injury, we recommend persons with medical implants to consult their physician and the medical implant manufacturer before operating this machine.**



**WARNING! Running an engine in a confined or badly ventilated area can result in death due to asphyxiation or carbon monoxide poisoning.**

## Personal protective equipment

### IMPORTANT!

A clearing saw, brushcutter or trimmer can be dangerous if used incorrectly or carelessly, and can cause serious or fatal injury to the operator or others. It is extremely important that you read and understand the contents of this operator's manual.

You must use approved personal protective equipment whenever you use the machine. Personal protective equipment cannot eliminate the risk of injury but it will reduce the degree of injury if an accident does happen. Ask your dealer for help in choosing the right equipment.



**WARNING! Listen out for warning signals or shouts when you are wearing hearing protection. Always remove your hearing protection as soon as the engine stops.**

### HELMET

A helmet should be worn if the trees being cleared are taller than 2 m.



### HEARING PROTECTION

Wear hearing protection that provides adequate noise reduction.



### EYE PROTECTION

Always wear approved eye protection. If you use a visor then you must also wear approved protective goggles. Approved protective goggles must comply with standard ANSI Z87.1 in the USA or EN 166 in EU countries.



### GLOVES

Gloves should be worn when necessary, e.g., when fitting cutting attachments.



# GENERAL SAFETY PRECAUTIONS

## BOOTS

Wear boots with steel toe-caps and non-slip sole.



## CLOTHING

Wear clothes made of a strong fabric and avoid loose clothing that can catch on twigs and branches. Always wear heavy, long pants. Do not wear jewellery, shorts sandals or go barefoot. Secure hair so it is above shoulder level.

## FIRST AID KIT

Always have a first aid kit nearby.



## Machine's safety equipment

This section describes the machine's safety equipment, its purpose, and how checks and maintenance should be carried out to ensure that it operates correctly. See the "What is what?" section to locate where this equipment is positioned on your machine.

The life span of the machine can be reduced and the risk of accidents can increase if machine maintenance is not carried out correctly and if service and/or repairs are not carried out professionally. If you need further information please contact your nearest service workshop.

**IMPORTANT!** All servicing and repair work on the machine requires special training. This is especially true of the machine's safety equipment. If your machine fails any of the checks described below you must contact your service agent. When you buy any of our products we guarantee the availability of professional repairs and service. If the retailer who sells your machine is not a servicing dealer, ask him for the address of your nearest service agent.



**WARNING!** Never use a machine with faulty safety equipment. The machine's safety equipment must be checked and maintained as described in this section. If your machine fails any of these checks contact your service agent to get it repaired.

## Throttle lockout

The throttle lockout is designed to prevent accidental operation of the throttle control. When you press the lock (A) (i.e. when you grasp the handle) it releases the throttle control (B). When you release the handle the throttle

control and the throttle lockout both move back to their original positions. This movement is controlled by two independent return springs. This arrangement means that the throttle control is automatically locked at the idle setting.

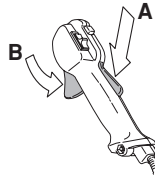

Make sure the throttle control is locked at the idle setting when the throttle lockout is released.

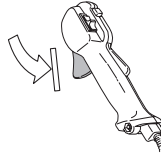

Press the throttle lockout and make sure it returns to its original position when you release it.

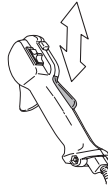

Check that the throttle control and throttle lockout move freely and that the return springs work properly.

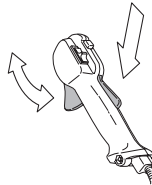

See instructions under the heading Start. Start the machine and apply full throttle. Release the throttle and check that the cutting attachment stops and remains at a standstill. If the cutting attachment rotates with the throttle in the idle position then the carburettor idle setting must

# GENERAL SAFETY PRECAUTIONS

be checked. See instructions under the heading Maintenance.

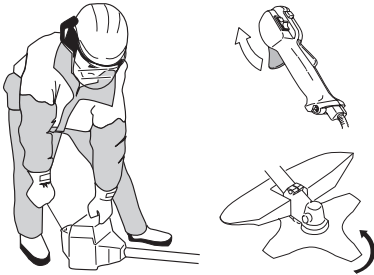

## Stop switch

Use the stop switch to switch off the engine.

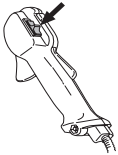

Start the engine and make sure the engine stops when you move the stop switch to the stop setting.

## Cutting attachment guard



This guard is intended to prevent loose objects from being thrown towards the operator. The guard also protects the operator from accidental contact with the cutting attachment.

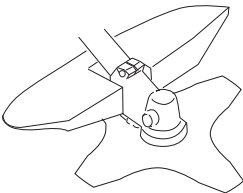

Check that the guard is undamaged and not cracked. Replace the guard if it has been exposed to impact or is cracked.

Always use the recommended guard for the cutting attachment you are using. See chapter on Technical data.



**WARNING! Never use a cutting attachment without an approved guard. See the chapter on Technical data. If an incorrect or faulty guard is fitted this can cause serious personal injury.**

## Vibration damping system

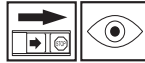

Your machine is equipped with a vibration damping system that is designed to minimize vibration and make operation easier.

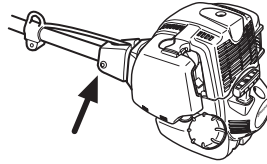

Using incorrectly wound cord or a blunt or incorrect cutting attachment (wrong type or incorrectly filed, see instructions under the heading Filing the blade) increases the level of vibration.

The machine's vibration damping system reduces the transfer of vibration between the engine unit/cutting equipment and the machine's handle unit.

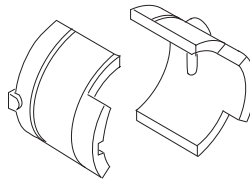

Regularly check the vibration damping units for cracks or deformation. Check that the vibration damping element is undamaged and securely attached.



**WARNING! Overexposure to vibration can lead to circulatory damage or nerve damage in people who have impaired circulation. Contact your doctor if you experience symptoms of overexposure to vibration. Such symptoms include numbness, loss of feeling, tingling, pricking, pain, loss of strength, changes in skin colour or condition. These symptoms normally appear in the fingers, hands or wrists. The risk increases at low temperatures.**

## Quick release

There is an easily accessible, quick release fitted at the front as a safety precaution in case the engine catches fire, or in any other situation that requires you to free yourself from the machine and harness. See instructions



# GENERAL SAFETY PRECAUTIONS

under the heading Adjusting the harness and brush cutter.



Check that the harness straps are correctly positioned. Once the harness and machine have been adjusted, check that the harness quick release works correctly.

## Muffler



The muffler is designed to keep noise levels to a minimum and to direct exhaust fumes away from the user. A muffler fitted with a catalytic converter is also designed to reduce harmful exhaust gases.



In countries that have a warm and dry climate there is a significant risk of fire. We therefore fit certain mufflers with a spark arrestor mesh. Check whether the muffler on your machine is fitted with this kind of mesh.

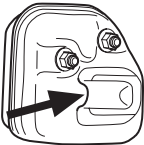

For mufflers it is very important that you follow the instructions on checking, maintaining and servicing your machine.

Never use a machine that has a faulty muffler.



Regularly check that the muffler is securely attached to the machine.



If the muffler on your machine is fitted with a spark arrestor mesh this must be cleaned regularly. A blocked mesh will cause the engine to overheat and may lead to serious damage.

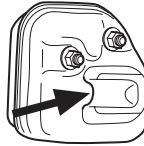

**WARNING!** Mufflers fitted with catalytic converters get very hot during use and remain so for some time after stopping. This also applies at idle speed. Contact can result in burns to the skin. Remember the risk of fire!

**WARNING!** The inside of the muffler contain chemicals that may be carcinogenic. Avoid contact with these elements in the event of a damaged muffler.

**WARNING!** Bear in mind that: The exhaust fumes from the engine are hot and may contain sparks which can start a fire. Never start the machine indoors or near combustible material!

## Locking nut



A locking nut is used to secure some types of cutting attachment.

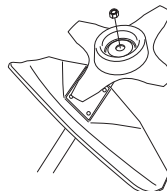

# GENERAL SAFETY PRECAUTIONS

When fitting, tighten the nut in the opposite direction to the direction of rotation of the cutting attachment. To remove it, undo the nut in the same direction as the cutting attachment rotates. (CAUTION! The nut has a left-hand thread.) Tighten the nut using the socket spanner.

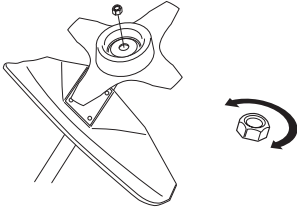

When loosening and tightening the saw blade nut, there is a risk of injury from the teeth of the saw blade. You should therefore always ensure that your hand is shielded by the blade guard when doing this. Always use a socket spanner with a shaft that is long enough to allow this. The arrow in the diagram shows the area where you should operate the socket spanner when loosening or tightening the nut.

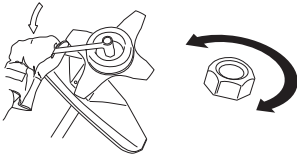

The nylon lining inside the locking nut must not be so worn that you can turn it by hand. The lining should offer a resistance of at least 1.5 Nm. The nut should be replaced after it has been put on approx. 10 times.

## Cutting equipment

This section describes how to choose and maintain your cutting equipment in order to:

- Reduce the risk of blade thrust.
- Obtain maximum cutting performance.
- Extend the life of cutting equipment.

### IMPORTANT!

Only use cutting attachments with the guards we recommend! See the chapter on Technical data.

Refer to the instructions for the cutting attachment to check the correct way to load the cord and the correct cord diameter.

Keep the teeth of the blade correctly sharpened! Follow our recommendations. Also refer to the instructions on the blade packaging.

Maintain the correct blade setting! Follow our instructions and use the recommended file gauge.



**WARNING!** Always stop the engine before doing any work on the cutting attachment. This continues to rotate even after the throttle has been released. Ensure that the cutting attachment has stopped completely and disconnect the HT lead from the spark plug before you start to work on it.



**WARNING!** Using an incorrect cutting attachment or an incorrectly sharpened blade increases the risk of blade thrust.

## Cutting equipment

Saw blades are intended for cutting fibrous types of wood.

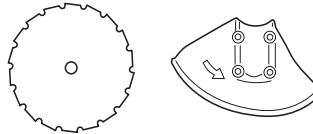

Grass blades and grass cutters are intended for cutting coarse grass.

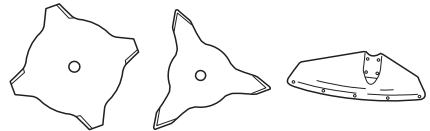

A trimmer head is intended for trimming grass.



## General rules



Only use cutting attachments with the guards we recommend! See the chapter on Technical data.



Keep the teeth of the blade correctly sharpened! Follow our instructions and use the recommended file gauge. An incorrectly sharpened or damaged blade increases the risk of accidents.

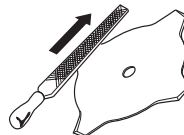

# GENERAL SAFETY PRECAUTIONS

Keep the correct setting on the saw blade! Follow our instructions and use the recommended setting tool. An incorrectly set saw blade increases the risk of jamming and blade thrust, and damage to the saw blade.

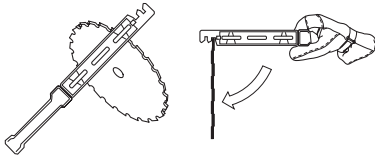

Check the cutting attachment for damage or cracks. A damaged cutting attachment should always be replaced.

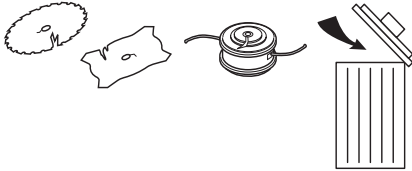

## Sharpening grass cutters and grass blades



- See the cutting attachment packaging for correct sharpening instructions. Sharpen blades and cutters using a single-cut flat file.
- Sharpen all edges equally to maintain the balance of the blade.

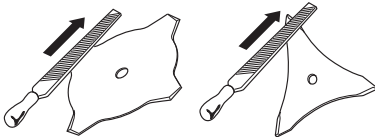

**WARNING!** Always discard a blade that is bent, twisted, cracked, broken or damaged in any other way. Never attempt to straighten a twisted blade so that it can be reused. Only use original blades of the specified type.

## Sharpening the saw blade



- See the cutting attachment packaging for correct sharpening instructions.

A correctly sharpened blade is essential for working efficiently and to avoid unnecessary wear to the blade and brush cutter.



- Make sure that the blade is well supported when you file it. Use a 5.5 mm round file with a file holder.

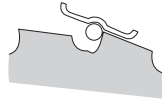

- The filing angle is 15°. File alternate teeth to the right and those in between to the left. If the blade has been heavily pitted by stones it may be necessary to dress the top edges of the teeth with a flat file, in exceptional cases. If so, this should be done before filing with a round file. The top edges must be filed down by the same amount for all the teeth.

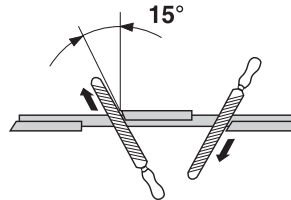

Adjust the blade setting. This should be 1 mm.

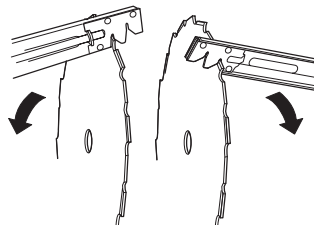

---

# GENERAL SAFETY PRECAUTIONS

---

## Trimmer head

### IMPORTANT!

Always ensure the trimmer cord is wound tightly and evenly around the drum, otherwise the machine will generate harmful vibration.

- Only use the recommended trimmer heads and trimmer cords. These have been tested by the manufacturer to suit a particular engine size. This is especially important when a fully automatic trimmer head is used. Only use the recommended cutting attachment. See the chapter on Technical data.

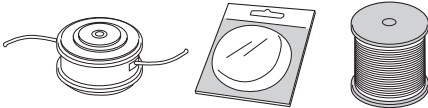

- Smaller machines generally require small trimmer heads and vice versa. This is because when clearing using a cord the engine must throw out the cord radially from the trimmer head and overcome the resistance of the grass being cleared.
- The length of the cord is also important. A longer cord requires greater engine power than a shorter cord of the same diameter.
- Make sure that the cutter on the trimmer guard is intact. This is used to cut the cord to the correct length.
- To increase the life of the cord it can be soaked in water for a couple of days. This will make the line tougher so that it lasts longer.

# ASSEMBLY

## Fitting the handlebar



- Remove the screw at the rear of the throttle handle.
- Slide the throttle handle onto the right side of the handlebar, (see diagram).

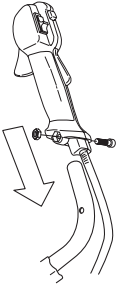

- Align the screw hole in the throttle handle with the hole in the handlebar.
- Refit the screw in the hole in the rear of the throttle handle.
- Screw the screw through the handle and handlebar. Tighten it.
- Unscrew the knob from the handlebar mounting.
- Position the handlebar as shown. Fit the mounting components and tighten the knob lightly.

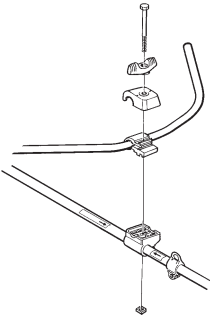

- Put on the harness and hang the machine from the support hook. Now make a final adjustment so that the machine is in a comfortable working position when it hangs from the harness. Tighten the knob.



## Transport position, handlebar



- The handlebar can easily be turned to fit along the shaft for easier transportation and storage.
- Loosen the knob. Turn the handlebar clockwise so that the throttle handle rests against the engine.
- Now twist the handlebar around the shaft. Tighten the knob.

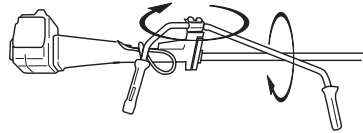

- Fit the transport guard to the cutting attachment.

## Assembling the cutting equipment



### WARNING!

When fitting the cutting attachment it is extremely important that the raised section on the drive disc/support flange engages correctly in the centre hole of the cutting attachment. If the cutting attachment is fitted incorrectly it can result in serious and/or fatal personal injury.

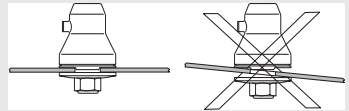

**WARNING!** Never use a cutting attachment without an approved guard. See the chapter on Technical data. If an incorrect or faulty guard is fitted this can cause serious personal injury.

**IMPORTANT!** If a saw blade or grass blade are to be used the machine must be equipped with the correct handlebar, blade guard and harness.

# ASSEMBLY

## Fitting a blade guard, grass blade and grass cutter

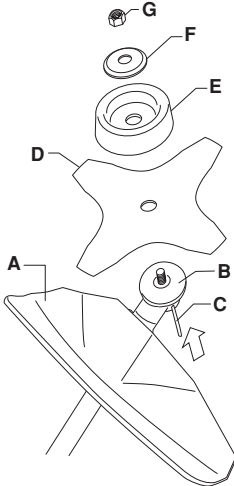
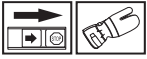

- Hook the blade guard/combination guard (A) onto the fitting on the shaft and secure with the bolt.

**CAUTION!** Use the recommended blade guard. See the Technical data section.

- Fit the drive disc (B) on the output shaft.
- Turn the blade shaft until one of the holes in the drive disc aligns with the corresponding hole in the gear housing.
- Insert the locking pin (C) in the hole to lock the shaft.
- Place the blade (D), support cup (E) and support flange (F) on the output shaft.
- Fit the nut (G). The nut must be tightened to a torque of 35-50 Nm (3.5-5 kpm). Use the socket spanner in the tool kit. Hold the shaft of the spanner as close to the blade guard as possible. To tighten the nut, turn the spanner in the opposite direction to the direction of rotation (Caution! left-hand thread).

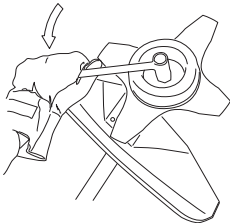

## Fitting the blade guard and saw blade

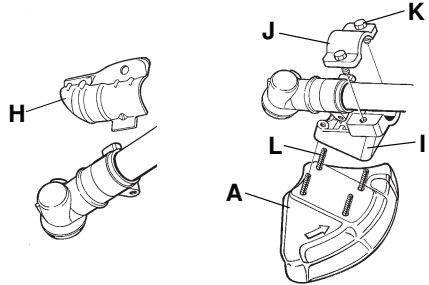

- Remove the mounting plate (H). Fit the adapter (I) and bracket (J) with the two screws (K) as shown. Fit the blade guard (A) to the adapter using the 4 screws (L) as shown.

**CAUTION!** Use the recommended blade guard. See the Technical data section.

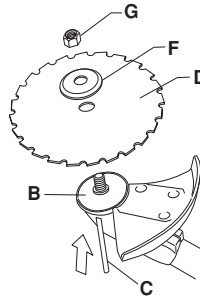

- Fit the drive disc (B) on the output shaft.
- Turn the blade shaft until one of the holes in the drive disc aligns with the corresponding hole in the gear housing.
- Insert the locking pin (C) in the hole to lock the shaft.
- Place the blade (D) and support flange (F) on the output shaft.
- Fit the nut (G). The nut must be tightened to a torque of 35-50 Nm (3.5-5 kpm). Use the socket spanner in the tool kit. Hold the shaft of the spanner as close to the blade guard as possible. To tighten the nut, turn

# ASSEMBLY

the spanner in the opposite direction to the direction of rotation (Caution! left-hand thread).

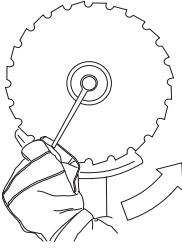

- When loosening and tightening the saw blade nut, there is a risk of injury from the teeth of the saw blade. You should therefore always ensure that your hand is shielded by the blade guard when doing this. Always use a socket spanner with a shaft that is long enough to allow this. The arrow in the diagram shows the area where you should operate the socket spanner when loosening or tightening the nut.

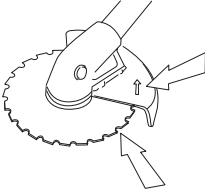

## Fitting a trimmer guard and Superauto II 1" trimmer head

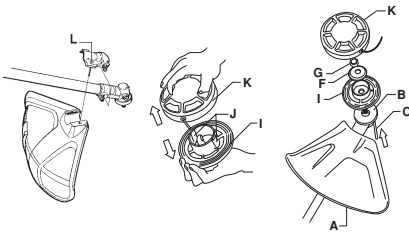

- Fit the correct trimmer guard (A) for use with the trimmer head. Hook the trimmer guard/combination guard onto the fitting on the shaft and secure with the bolt (L).
- Fit the drive disc (B) on the output shaft.
- Turn the blade shaft until one of the holes in the drive disc aligns with the corresponding hole in the gear housing.
- Insert the locking pin (C) in the hole to lock the shaft.
- To fit the trimmer head, first separate the two halves (see diagram). Proceed as follows:

Insert a finger into the centre hole of the cover (I) while grasping the cover with your other fingers. Using the index finger and thumb of your other hand, release the two catches (J) that engage in the cut-outs in the bottom half (K). Pull apart the trimmer head, grasping the cover firmly.

- Place the cover (I) and the support flange (F) on the output shaft.
- Fit the nut (G). Tighten the nut to a torque of 35-50 Nm (3.5-5 kpm). Use the socket spanner in the tool kit. Grasp the handle of the spanner as close to the trimmer guard as possible.
- To tighten the nut, turn the spanner in the opposite direction to the direction of rotation (Caution! left-hand thread).

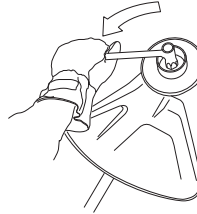

- Fit the bottom half of the trimmer head (K) to the cover (I) by pressing them together, with the cut-outs on the bottom half aligned with the catches on the cover.

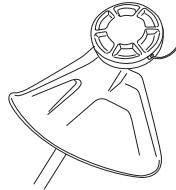

- To dismantle, follow the instructions in the reverse order.

## Fitting other guards and cutting attachments



- Fit the trimmer guard/combination guard (A) intended for use with the trimmer head/plastic blades. Hook the

# ASSEMBLY

guard onto the fitting on the shaft and secure it with the bolt (L).

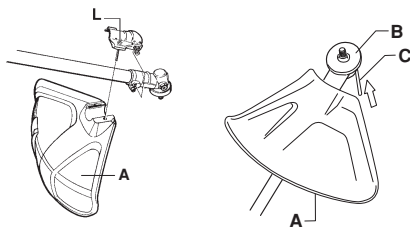

- Fit the drive disc (B) on the output shaft.
- Turn the blade shaft until one of the holes in the drive disc aligns with the corresponding hole in the gear housing.
- Insert the locking pin (C) in the hole to lock the shaft.
- Screw on the trimmer head/plastic blades (H) in the opposite direction to the direction of rotation.

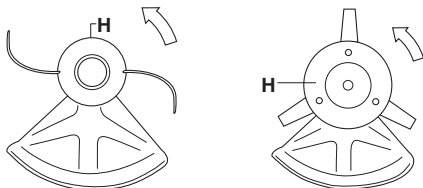

- To dismantle, follow the instructions in the reverse order.

## Adjusting the harness and brush cutter



**WARNING!** When using a brush cutter it must always be hooked securely to the harness. Otherwise you will be unable to control the brush cutter safely and this can result in injury to yourself or others. Never use a harness with a defective quick release.

## Standard harness



### Quick release

At the front is an easily accessible, quick release. Use this if the engine catches fire or in any other emergency

situation that requires you to free yourself from the machine and harness.

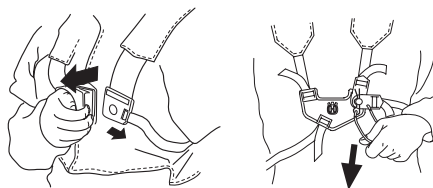

## Spreading the load on your shoulders

A well-adjusted harness and machine makes work much easier. Adjust the harness for the best working position. Tension the side straps so that the weight is evenly distributed across both shoulders.



## Correct height

Adjust the shoulder strap so that the cutting attachment is parallel to the ground.



## Correct balance

Let the cutting attachment rest lightly on the ground. If you use a saw blade it should balance about 10 cm above the ground to prevent contact with stones and the like. Adjust the position of the suspension ring to balance the brush cutter correctly.





# FUEL HANDLING

## Fuel handling

Never start the machine:

- 1 If you have spilt fuel on it. Wipe off the spillage and allow remaining fuel to evaporate.
- 2 If you have spilt fuel on yourself or your clothes, change your clothes. Wash any part of your body that has come in contact with fuel. Use soap and water.
- 3 If the machine is leaking fuel. Check regularly for leaks from the fuel cap and fuel lines.

## Transport and storage

- Store and transport the machine and fuel so that there is no risk of any leakage or fumes coming into contact with sparks or naked flames, for example, from electrical machinery, electric motors, electrical relays/ switches or boilers.
- When storing and transporting fuel always use approved containers intended for this purpose.
- When storing the machine for long periods the fuel tank must be emptied. Contact your local petrol station to find out where to dispose of excess fuel.
- The transport guard must always be fitted to the cutting attachment when the machine is being transported or in storage.
- Secure the machine during transport.
- Ensure the machine is cleaned and that a complete service is carried out before long-term storage.



**WARNING! Take care when handling fuel. Bear in mind the risk of fire, explosion and inhaling fumes.**

## Fuel



**CAUTION!** The machine is equipped with a four-stroke engine. Make sure that there is always sufficient oil in the oil tank.



**WARNING! Fuel and fuel fumes are highly inflammable and can cause serious injury when inhaled or allowed to come in contact with the skin. For this reason observe caution when handling fuel and make sure there is adequate ventilation.**



**WARNING! The catalytic converter muffler gets very hot during and after use. This also applies during idling. Be aware of the fire hazard, especially when working near flammable substances and/ or vapours.**

## Petrol

Always use an unleaded quality petrol of at least 90 octane (RON).

Use low-emission petrol, also known as alkylate petrol, if it is available.

- The lowest recommended octane grade is 90 (RON). If you run the engine on a lower octane grade than 90 so-called knocking can occur. This gives rise to a high engine temperature and increased bearing load, which can result in serious engine damage.
- When working at continuous high revs a higher octane rating is recommended.
- If the machine is not used for some time the fuel tank should be emptied and cleaned.

## Engine oil

Check the oil level before starting the machine. A too low oil level can cause serious damage to the engine.

When the machine is new the engine oil should be changed after the first month or after 10 hours of operation.

- For the best result and function use HUSQVARNA engine oil.
- When HUSQVARNA engine oil is not available another high grade engine oil can be used. Contact your dealer when selecting oil. Engine oil for four-stroke petrol engines must be used. Quality class at least API SG. In general viscosity class SAE 10W-40 is recommended.
- Never use oil intended for two-stroke engines.

## Oil level

The machine must be switched off and placed on a flat surface when you check the oil level.

Unscrew the oil cap, clean the dipstick located on the cap and insert the cap again without screwing it down. Check the oil level on the dipstick.

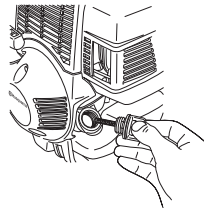

## FUEL HANDLING

When the oil level is low, top up using engine oil to the edge of the oil refill hole.

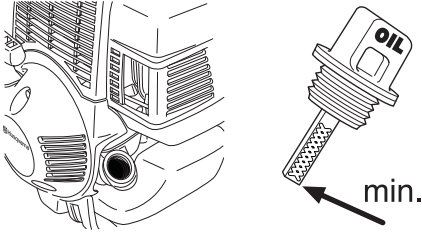

Only use recommended engine oil.

### Fuelling



**WARNING!** Taking the following precautions, will lessen the risk of fire:

**Do not smoke or place hot objects near fuel.**

**Always shut off the engine before refuelling.**

**Always stop the engine and let it cool for a few minutes before refuelling.**

**When refuelling, open the fuel cap slowly so that any excess pressure is released gently.**

**Tighten the fuel cap carefully after refuelling.**

**Always move the machine away from the refuelling area before starting.**

Clean around the fuel cap. Clean the fuel and oil tank regularly. The fuel filter should be changed at least once a year. Contamination in the tanks causes malfunction.

Always move the machine about 3 metres from the refuelling position before starting.

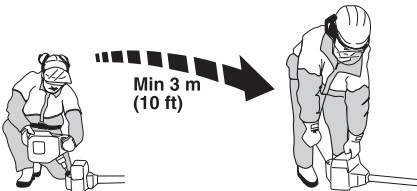

# STARTING AND STOPPING

## Check before starting



- Check the blade to ensure that no cracks have formed at the bottom of the teeth or by the centre hole. The most common reason why cracks are formed is that sharp corners have been formed at the bottom of the teeth while sharpening or that the blade has been used with dull teeth. Discard a blade if cracks are found.

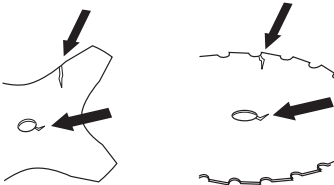

- Check that the support flange is not cracked due to fatigue or due to being tightened too much. Discard the support flange if it is cracked.

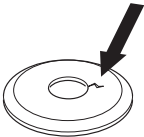

- Ensure the locking nut has not lost its captive force. The nut lock should have a locking force of at least 1.5 Nm. The tightening torque of the locking nut should be 35-50 Nm.



- Check that the blade guard is not damaged or cracked. Replace the blade guard if it is exposed to impact or is cracked.

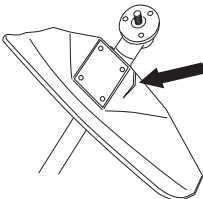

- Check that the trimmer head and trimmer guard are not damaged or cracked. Replace the trimmer head or

trimmer guard if they have been exposed to impact or are cracked.

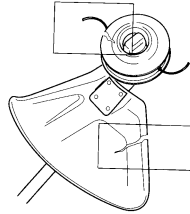

- Never use the machine without a guard nor with a defective guard.
- All covers must be correctly fitted and undamaged before you start the machine.

## Starting and stopping



**WARNING!** The complete clutch cover and shaft must be fitted before the machine is started, otherwise the clutch can come loose and cause personal injury.

Always move the machine away from the refuelling area before starting. Place the machine on a flat surface. Ensure the cutting attachment cannot come into contact with any object.

Make sure no unauthorised persons are in the working area, otherwise there is a risk of serious personal injury. The safety distance is 15 metres.

## Cold engine

**Ignition:** Set the stop switch to the start position.

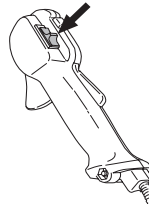

**Choke:** Set the choke control in the choke position.

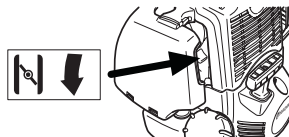

# STARTING AND STOPPING

**Primer bulb:** Press the air purge repeatedly until fuel begins to fill the bulb. The bulb need not be completely filled.

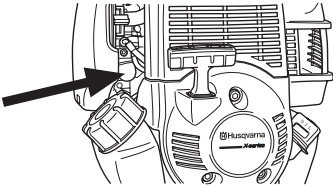

## Warm engine

**Ignition:** Set the stop switch to the start position.

**Choke:** Put the choke in working position.

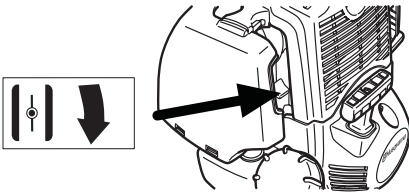

**Primer bulb:** Press the air purge repeatedly until fuel begins to fill the bulb. The bulb need not be completely filled.

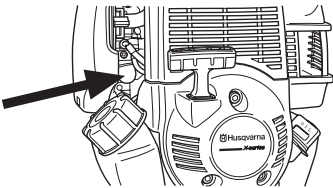

## For throttle handles with a start throttle lock:

Set the throttle to the start position by first pressing the throttle lockout and the throttle trigger, then pressing the start throttle button (A). Then release the throttle lockout and the throttle trigger, followed by the start throttle button. The throttle function is now activated. To return the engine to idle, press the throttle lockout and throttle trigger again.

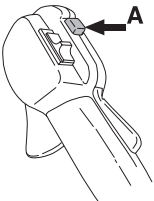

## Starting



**WARNING!** When the engine is started with the choke in either the choke or start throttle positions the cutting attachment will start to rotate immediately.

Hold the body of the machine on the ground using your left hand (CAUTION! Not with your foot!). Grip the starter handle, slowly pull out the cord with your right hand until you feel some resistance (the starter pawls grip), now quickly and powerfully pull the cord. **Never twist the starter cord around your hand.**

Repeat pulling the cord until the engine starts. When the engine starts, return choke control to run position and apply full throttle; the throttle will automatically disengage from the start setting.

**CAUTION!** Do not pull the starter cord all the way out and do not let go of the starter handle when the cord is fully extended. This can damage the machine.



## Stopping



Stop the engine by switching off the ignition.

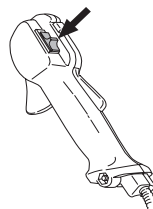

# WORKING TECHNIQUES

## General working instructions

### IMPORTANT!

This section describes the basic safety precautions for working with brush cutters and trimmers.

If you encounter a situation where you are uncertain how to proceed you should ask an expert. Contact your dealer or your service workshop.

Avoid all usage which you consider to be beyond your capability.

You must understand the difference between forestry clearing, grass clearing and grass trimming before use.

## Basic safety rules



1 Look around you:

- To ensure that people, animals or other things cannot affect your control of the machine.
- To ensure that people, animals, etc., do not come into contact with the cutting attachment or loose objects that are thrown out by the cutting attachment.
- CAUTION! Do not use the machine unless you are able to call for help in the event of an accident.

2 Inspect the working area. Remove all loose objects, such as stones, broken glass, nails, steel wire, string, etc. that could be thrown out or become wrapped around the cutting attachment.

3 Do not use the machine in bad weather, such as dense fog, heavy rain, strong wind, intense cold, etc. Working in bad weather is tiring and often brings added risks, such as icy ground, unpredictable felling direction, etc.

4 Make sure you can move and stand safely. Check the area around you for possible obstacles (roots, rocks, branches, ditches, etc.) in case you have to move suddenly. Take great care when working on sloping ground.



5 Take great care when cutting a tree that is in tension. A tree that is in tension may spring back to its normal position before or after being cut. If you position

yourself incorrectly or make the cut in the wrong place the tree may hit you or the machine and cause you to lose control. Both situations can cause serious personal injury.

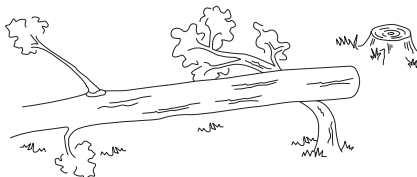

6 Keep a good balance and a firm foothold.

7 Always hold the machine with both hands. Hold the machine on the right side of your body.



8 Keep the cutting attachment below waist level.

9 Switch off the engine before moving to another area. Fit the transport guard before carrying or transporting the equipment any distance.

10 Never put the machine down with the engine running unless you have it in clear sight.

## The ABC of clearing

- Always use the correct equipment.
- Make sure the equipment is well adjusted.
- Follow the safety precautions.
- Organise your work carefully.
- Always use full throttle when starting to cut with the blade.
- Always use sharp blades.
- Avoid stones.

## WORKING TECHNIQUES

- Control the felling direction (take advantage of the wind).



**WARNING!** Neither the operator of the machine nor anyone else may attempt to remove the cut material while the engine is running or the cutting equipment is rotating, as this can result in serious injury.

Stop the engine and cutting equipment before you remove material that has wound around the blade shaft as otherwise there is a risk of injury. The bevel gear can get hot during use and may remain so for a while afterwards. You could get burnt if you touch it.



**WARNING!** Watch out for thrown objects. Always wear approved eye protection. Never lean over the cutting attachment guard. Stones, rubbish, etc. can be thrown up into the eyes causing blindness or serious injury.

Keep unauthorised persons at a distance. Children, animals, onlookers and helpers should be kept outside the safety zone of 15 m. Stop the machine immediately if anyone approaches. Never swing the machine around without first checking behind you to make sure no-one is within the safety zone.



**WARNING!** Sometimes branches or grass get caught between the guard and cutting attachment. Always stop the engine before cleaning.

### Working methods



**WARNING!** Machines fitted with saw blades or grass blades can be thrown violently to the side when the blade comes into contact with a fixed object. This is called blade thrust. A blade thrust can be violent enough to cause the machine and/or operator to be propelled in any direction, and possibly lose control of the machine. Blade thrust can occur without warning if the machine snags, stalls or binds. Blade thrust is more likely to occur in areas where it is difficult to see the material being cut.

Avoid cutting with the area of the blade between the 12 o'clock and 3 o'clock positions. Because of the speed of rotation of the blade, blade thrust can occur if you attempt to cut thick stems with this area of the blade.

- Before you start clearing, check the clearing area, the type of terrain, the slope of the ground, whether there are stones, hollows etc.

- Start at whichever end of the area is easiest, and clear an open space from which to work.
- Work systematically to and fro across the area, clearing a width of around 4-5 m on each pass. This exploits the full reach of the machine in both directions and gives the operator a convenient and varied working area to work in.

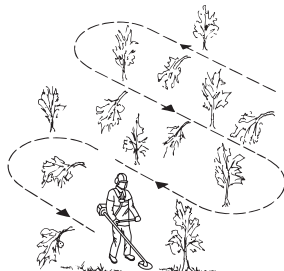

- Clear a strip around 75 m long. Move your fuel can as work progresses.
- On sloping ground you should work along the slope. It is much easier to work along a slope than it is to work up and down it.
- You should plan the strip so that you avoid going over ditches or other obstacles on the ground. You should also orient the strip to take advantage of wind conditions, so that cleared stems fall in the cleared area of the stand.

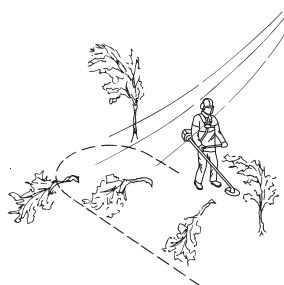

### Forestry clearing using a saw blade



- The risk of blade thrust increases with increasing stem size. You should therefore avoid cutting with the area of the blade between 12 o'clock and 3 o'clock.

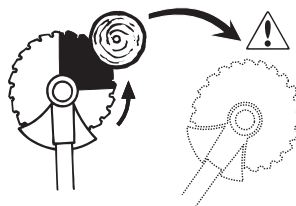

# WORKING TECHNIQUES

- To fell to the left, the bottom of the tree should be pushed to the right. Tilt the blade and bring it diagonally down to the right, exerting firm pressure. At the same time push the stem using the blade guard. Cut with the area of the blade between 3 o'clock and 5 o'clock. Apply full throttle before advancing the blade.

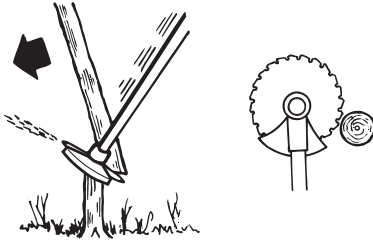

- To fell to the right, the bottom of the tree should be pushed to the left. Tilt the blade and bring it diagonally up to the right. Cut with the area of the blade between 3 o'clock and 5 o'clock so that the direction of rotation of the blade pushes the bottom of the tree to the left.

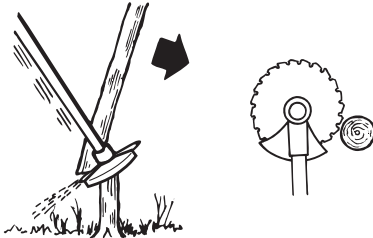

- To fell a tree forwards, the bottom of the tree should be pulled backwards. Pull the blade backwards with a quick, firm movement.

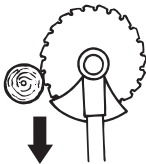

- Large stems must be cut from two sides. First determine which direction the stem will fall. Make the first cut on the felling side. Then finish cutting the stem from the other side. Adjust the cutting pressure to match the size of the stem and the hardness of the

wood. Small stems require more pressure, while large stems require less pressure.

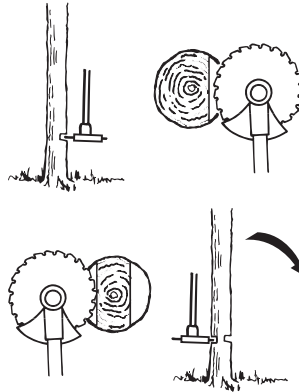

- If the stems are tightly packed, adapt your walking pace to suit.
- If the blade jams in a stem, never jerk the machine free. If you do this the blade, bevel gear, shaft or handlebar may be damaged. Release the handles, grip the shaft with both hands and gently pull the machine free.

## Brush cutting with a saw blade



- Thin stems and brush are mown down. Work with a sawing movement, swinging sideways.
- Try to cut several stems in a single sawing movement.
- With groups of hardwood stems, first clear around the group. Start by cutting the stems high up around the outside of the group to avoid jamming. Then cut the stems to the required height. Now try to reach in with the blade and cut from the centre of the group. If it is still difficult to gain access, cut the stems high up and let them fall. This will reduce the risk of jamming.

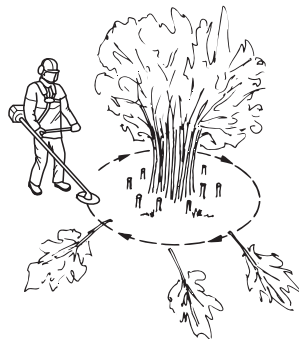

# WORKING TECHNIQUES

## Grass clearing using a grass blade



- Grass blades and grass cutters must not be used on woody stems.
- A grass blade is used for all types of tall or coarse grass.
- The grass is cut down with a sideways, swinging movement, where the movement from right-to-left is the clearing stroke and the movement from left-to-right is the return stroke. Let the left-hand side of the blade (between 8 and 12 o'clock) do the cutting.

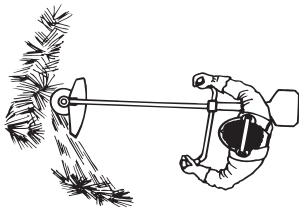

- If the blade is angled to the left when clearing grass, the grass will collect in a line, which makes it easier to collect, e.g. by raking.
- Try to work rhythmically. Stand firmly with your feet apart. Move forward after the return stroke and stand firmly again.
- Let the support cup rest lightly against the ground. It is used to protect the blade from hitting the ground.
- Reduce the risk of material wrapping around the blade by following these instructions:
  - 1 Always work at full throttle.
  - 2 Avoid the previously cut material during the return stroke.
- Stop the engine, unclip the harness and place the machine on the ground before you start to collect the cut material.

## Grass trimming with a trimmer head



### Trimming

- Hold the trimmer head just above the ground at an angle. It is the end of the cord that does the work. Let the cord work at its own pace. Never press the cord into the area to be cut.

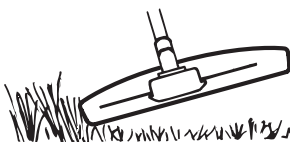

- The cord can easily remove grass and weeds up against walls, fences, trees and borders, however it

can also damage sensitive bark on trees and bushes, and damage fence posts.

- Reduce the risk of damaging plants by shortening the cord to 10-12 cm and reducing the engine speed.

### Clearing

- The clearing technique removes all unwanted vegetation. Keep the trimmer head just above the ground and tilt it. Let the end of the cord strike the ground around trees, posts, statues and the like. CAUTION! This technique increases the wear on the cord.

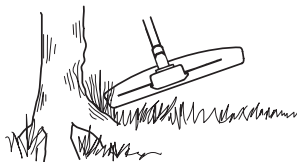

- The cord wears quicker and must be fed forward more often when working against stones, brick, concrete, metal fences, etc., than when coming into contact with trees and wooden fences.
- When trimming and clearing you should use less than full throttle so that the cord lasts longer and to reduce the wear on the trimmer head.

### Cutting

- The trimmer is ideal for cutting grass that is difficult to reach using a normal lawn mower. Keep the cord parallel to the ground when cutting. Avoid pressing the trimmer head against the ground as this can ruin the lawn and damage the tool.

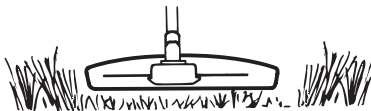

- Do not allow the trimmer head to constantly come into contact with the ground during normal cutting. Constant contact of this type can cause damage and wear to the trimmer head.

### Sweeping

- The fan effect of the rotating cord can be used for quick and easy clearing up. Hold the cord parallel to and above the area to be swept and move the tool to and fro.

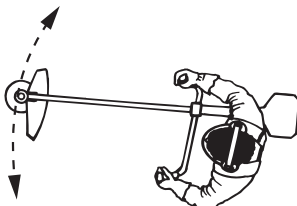

- When cutting and sweeping you should use full throttle to obtain the best results.



# MAINTENANCE

## Carburettor



**WARNING!** The complete clutch cover and shaft must be fitted before the machine is started, otherwise the clutch can come loose and cause personal injury.

### Function



- The carburettor governs the engine's speed via the throttle control. Air and fuel are mixed in the carburettor.
- Setting the carburettor involves adapting the engine to suit local conditions, e.g. climate, altitude and the petrol.

### Basic setting

The basic carburettor settings are adjusted during testing at the factory.

**CAUTION!** For optimum adjustment of the carburettor, contact a qualified dealer/service workshop that has a revolution counter at their disposal.

### Adjusting the idle speed (T)

Check that the air filter is clean. When the idle speed is correct, the cutting attachment should not rotate. If adjustment is required, close (turn clockwise) the idle adjustment screw T, with the engine running, until the cutting attachment starts to rotate. Open (turn anticlockwise) the screw until the cutting attachment stops. The idle speed is correctly set when the engine runs smoothly in all positions, and there is a clear margin to the speed at which the cutting attachment starts to rotate.

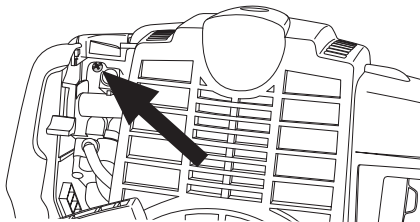

**WARNING!** If the idle speed cannot be adjusted so that the cutting attachment stops, contact your dealer/service workshop. Do not use the machine until it has been correctly adjusted or repaired.

## Muffler

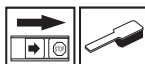

**CAUTION!** Some mufflers are fitted with a catalytic converter. See chapter on Technical data to see whether your machine is fitted with a catalytic converter.

The muffler is designed to reduce the noise level and to direct the exhaust gases away from the operator. The exhaust gases are hot and can contain sparks, which may cause fire if directed against dry and combustible material.

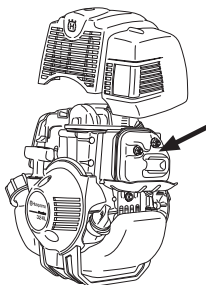

The muffler on your machine is equipped with a spark arrestor mesh, this should be cleaned regularly. A blocked mesh will cause the engine to overheat and may lead to serious damage.

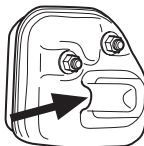

**CAUTION!** Never use a machine with a defective muffler.



**WARNING!** Mufflers fitted with catalytic converters get very hot during use and remain so for some time after stopping. This also applies at idle speed. Contact can result in burns to the skin. Remember the risk of fire!

# MAINTENANCE

## Cooling system



To keep the working temperature as low as possible the machine is equipped with a cooling system.

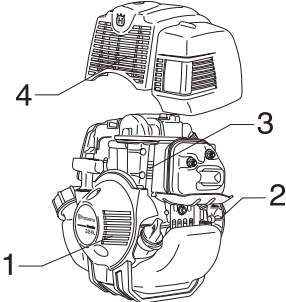

The cooling system consists of:

- 1 Air intake on the starter.
- 2 Fins on the flywheel.
- 3 Cooling fins on the cylinder.
- 4 Cylinder cover (directs cold air over the cylinder).

Clean the cooling system with a brush once a week, more often in demanding conditions. A dirty or blocked cooling system results in the machine overheating which causes damage to the piston and cylinder.

## Spark plug



The spark plug condition is influenced by:

- Incorrect carburettor adjustment.
- A dirty air filter.

These factors cause deposits on the spark plug electrodes, which may result in operating problems and starting difficulties.

If the machine is low on power, difficult to start or runs poorly at idle speed: always check the spark plug first before taking any further action. If the spark plug is dirty, clean it and check that the electrode gap is 0,6-0,7 mm. The spark plug should be replaced after about a month in operation or earlier if necessary.

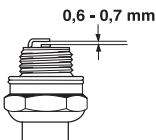

**CAUTION!** Always use the recommended spark plug type! Use of the wrong spark plug can damage the piston/

cylinder. Check that the spark plug is fitted with a suppressor.

## Air filter

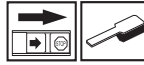

The air filter must be regularly cleaned to remove dust and dirt in order to avoid:

- Carburettor malfunctions
- Starting problems
- Loss of engine power
- Unnecessary wear to engine parts.
- Excessive fuel consumption.

Clean the filter every 25 hours, or more regularly if conditions are exceptionally dusty.

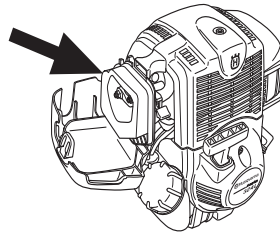

## Cleaning the air filter

Remove the air filter cover and take out the filter. Wash it clean in warm, soapy water. Ensure that the filter is dry before refitting it.

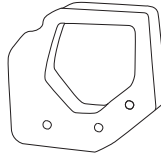

An air filter that has been in use for a long time cannot be cleaned completely. The filter must therefore be replaced with a new one at regular intervals. **A damaged air filter must always be replaced.**

If the machine is used in dusty conditions the air filter should be soaked in oil. See instructions under the heading Oiling the air filter.

## Oiling the air filter

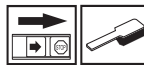

Always use HUSQVARNA filter oil, art. no. 531 00 92-48. The filter oil contains a solvent to make it spread evenly through the filter. You should therefore avoid skin contact.

Put the filter in a plastic bag and pour the filter oil over it. Knead the plastic bag to distribute the oil. Squeeze the

---

## MAINTENANCE

---

excess oil out of the filter inside the plastic bag and pour off the excess before fitting the filter to the machine. Never use common engine oil. This would drain through the filter quite quickly and collect in the bottom.

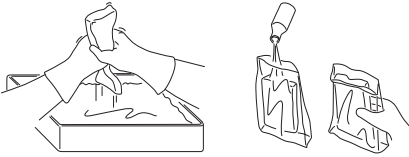

### Bevel gear



The bevel gear is filled with the right quantity of grease at the factory. However, before using the machine you should check that the bevel gear is filled three-quarters full with grease. Use HUSQVARNA special grease.

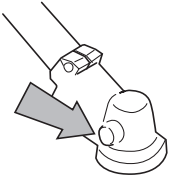

The grease in the bevel gear does not normally need to be changed except if repairs are carried out.

# MAINTENANCE

## Maintenance schedule

The following is a list of the maintenance that must be performed on the machine. Most of the items are described in the Maintenance section. The user must only carry out the maintenance and service work described in this Operator's Manual. More extensive work must be carried out by an authorized service workshop.

Maintenance	Daily maintenance	Weekly maintenance	Monthly maintenance
Clean the outside of the machine.	X		
Check that the harness is not damaged.	X		
Check that the suspension ring is not damaged.	X		
Make sure the throttle trigger lock and the throttle function correctly from a safety point of view.	X		
Check that the stop switch works correctly.	X		
Check that the handle and handlebar are undamaged and secured correctly.	X		
Check that the cutting attachment does not rotate at idle.	X		
Clean the air filter. Replace if necessary.	X		
Check that the guard is undamaged and not cracked. Replace the guard if it has been exposed to impact or is cracked.	X		
Check that the blade is correctly centred, is sharp, and is not cracked. An off-centre blade will cause vibration that could result in damage to the machine.	X		
Check that the trimmer head is undamaged and not cracked. Replace the trimmer head if necessary.	X		
Check that the locking nut of the cutting equipment is tighten correctly.	X		
Check that nuts and screws are tight.	X		
Check that there are no fuel leaks from the engine, tank or fuel lines.	X		
Check that the transport guard for the blade is intact and that it can be secured correctly.	X		
Check the engine oil level and top up if necessary.	X		
Check the starter and starter cord.		X	
Check that the vibration damping elements are not damaged.		X	
Clean the outside of the spark plug. Remove it and check the electrode gap. Adjust the gap to 0,6-0,7 mm or replace the spark plug. Check that the spark plug is fitted with a suppressor.		X	
Clean the machine's cooling system.		X	
Clean or replace the spark arrestor mesh on the muffler (only applies to mufflers without a catalytic converter).		X	
Clean the outside of the carburettor and the space around it.		X	
Check that the bevel gear is filled three-quarters full with lubricant. Fill if necessary using special grease.		X	
Check the fuel filter from contamination and the fuel hose from cracks or other defects. Replace if necessary.			X
Check all cables and connections.			X
Check the clutch, clutch springs and the clutch drum for wear. Replace if necessary by an authorized service workshop.			X
Replace the spark plug. Check that the spark plug is fitted with a suppressor.			X
Check and clean the spark arrestor mesh on the muffler (only applies to mufflers fitted with a catalytic converter).			X
Change the engine oil.			X

---

# TECHNICAL DATA

---

## Technical data

	324Rx
<b>Engine</b>	
Cylinder displacement, cm <sup>3</sup>	25,0
Cylinder bore, mm	35
Stroke, mm	26
Idle speed, rpm	3100
Recommended max. speed, rpm	11000
Speed of output shaft, rpm	8300
Max. engine output, acc. to ISO 8893, kW/ rpm	0,8 / 7000
Catalytic converter muffler	No
Speed-regulated ignition system	No
<b>Ignition system</b>	
Spark plug	NGK CMR5H
Electrode gap, mm	0,6
<b>Fuel and lubrication system</b>	
Fuel tank capacity, litre	0,5
<b>Weight</b>	
Weight without fuel, cutting attachment and guard, kg	5,5
<b>Noise emissions</b>	
(see note 1)	
Sound power level, measured dB(A)	105
Sound power level, guaranteed L <sub>WA</sub> dB(A)	106
<b>Noise levels</b>	
(see note 2)	
Equivalent sound pressure level at the operator's ear, measured according to EN ISO 11806 and ISO 22868, dB(A):	
Equipped with trimmer head (original)	93
Equipped with grass blade (original)	89
<b>Vibration levels</b>	
(see note 3)	
Equivalent vibration levels (a <sub>h,eq</sub> ) at handles, measured according to EN ISO 11806 and ISO 22867, m/s <sup>2</sup>	
Equipped with trimmer head (original), left/right	2,9/3,1
Equipped with grass blade (original), left/right	2,7/2,2

Note 1: Noise emissions in the environment measured as sound power (L<sub>WA</sub>) in conformity with EC directive 2000/14/EC. Reported sound power level for the machine has been measured with the original cutting attachment that gives the highest level. The difference between guaranteed and measured sound power is that the guaranteed sound power also includes dispersion in the measurement result and the variations between different machines of the same model according to Directive 2000/14/EC.

Note 2: Reported data for equivalent sound pressure level for the machine has a typical statistical dispersion (standard deviation) of 1 dB (A).

Note 3: Reported data for equivalent vibration level has a typical statistical dispersion (standard deviation) of 1 m/s<sup>2</sup>.

## TECHNICAL DATA

Approved accessories	Type	Cutting attachment guard, Art. no.
Blade shaft thread M10		
Grass blade/grass cutter	Grass 255-4 1" (Ø 255 4-teeth)	503 93 42-02
	Grass 255-8 1" (Ø 250 8-teeth)	503 93 42-02
Saw blade	Maxi X 200-26 1" (Ø 200 26 teeth)	537 21 71-01
	Scarlet 200-22 1" (Ø 200 22 teeth)	537 21 71-01
Plastic blades	Tricut Ø 255 mm (Separate blades have part number 531 01 77-15)	503 93 42-02 / 503 97 71-01
	Tricut Ø 300 mm (Separate blades have part number 531 01 77-15)	503 93 42-02
Trimmer head	Trimmy Fix (Ø 2.4 mm cord)	503 93 42-02 / 503 97 71-01
	Superauto II (Ø 2.4 - 2.7 mm cord)	503 93 42-02 / 503 97 71-01
	S35 (Ø 2.4 - 3.0 mm cord)	503 93 42-02 / 503 97 71-01
	T25 (Ø 2.0 - 2.7 mm cord)	503 93 42-02 / 503 97 71-01
	T35, T35x (Ø 2.4 - 3.0 mm cord)	503 93 42-02 / 503 97 71-01
Support cup	Fixed	-

### EC-declaration of conformity (Applies to Europe only)

We, **Husqvarna AB**, SE-561 82 Huskvarna, Sweden, tel: +46-36-146500, declare that the brush cutters **Husqvarna 324Rx** with serial numbers dating from 2009 onwards (the year is clearly stated on the rating plate, followed by the serial number), comply with the requirements of the COUNCIL'S DIRECTIVE:

- of May 17, 2006 "relating to machinery" **2006/42/EC**
- of December 15, 2004 "relating to electromagnetic compatibility" **2004/108/EC**.
- of May 8, 2000 "relating to the noise emissions in the environment" **2000/14/EC**. Conformity assessment according to Annex V.

For information relating to noise emissions, see the chapter Technical data.

The following standards have been applied: **EN ISO 12100-2/A1:2009, CISPR 12:2001, EN ISO 11806:2008**

SMP Svensk Maskinprovning AB, Fyrisborgsgatan 3, SE-754 50 Uppsala, Sweden, has performed voluntary type examination on behalf of Husqvarna AB. The certificates are numbered: **SEC/09/2169, 01/164/039**

Huskvarna December 29, 2009



Bo Jonsson, Development manager (Authorized representative for Husqvarna AB and responsible for technical documentation.)

# Super Auto II Super Auto II 1"



1

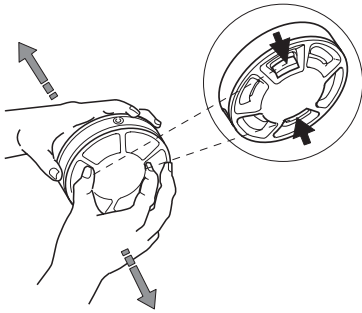

2

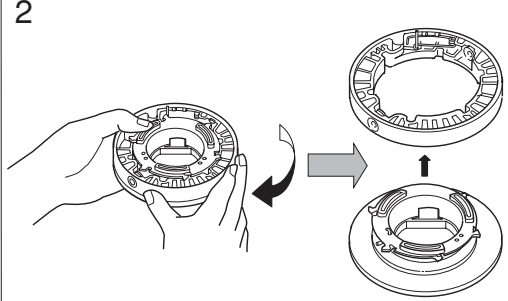

3

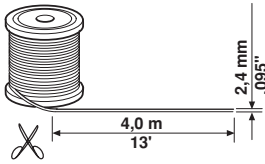

4

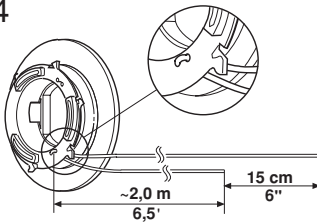

5

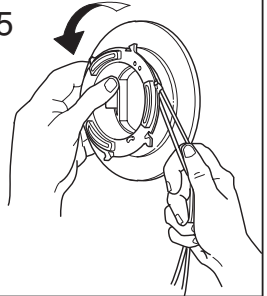

6

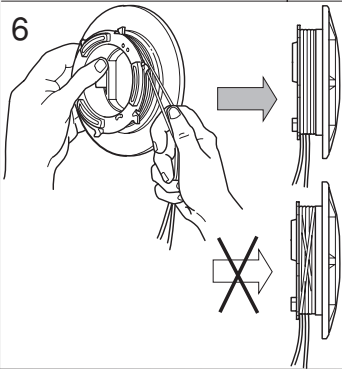

7

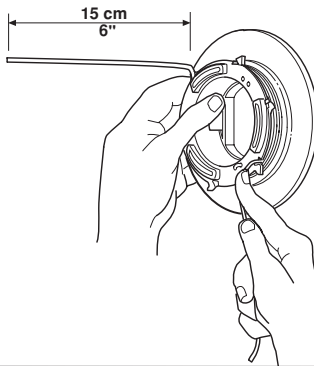

8

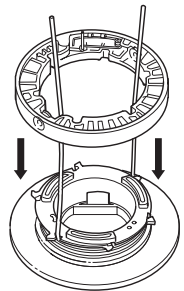

9

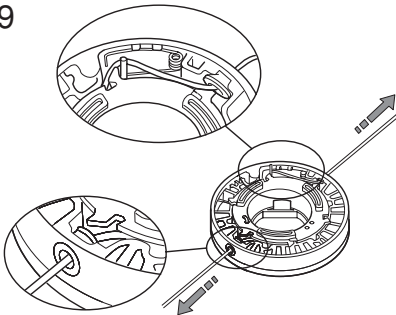

10

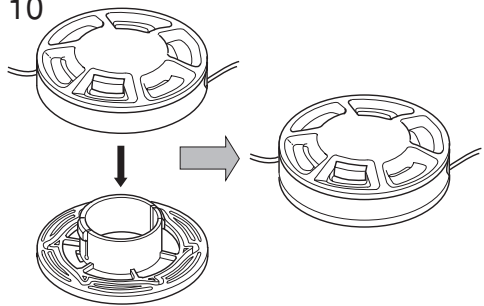

# Tri Cut



1

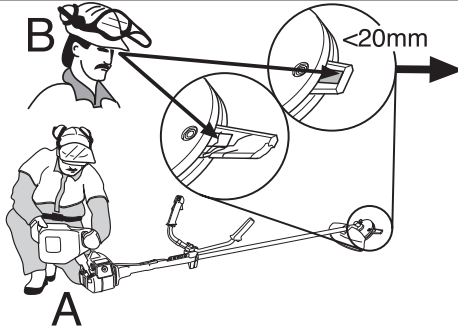

2

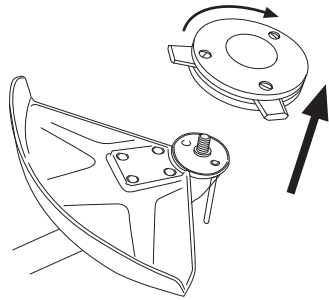

3

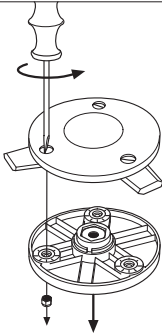

4

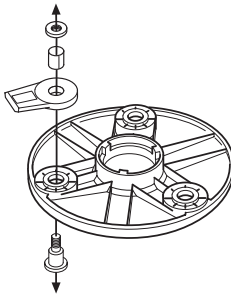

5

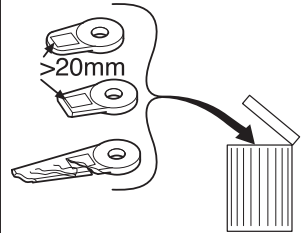

6

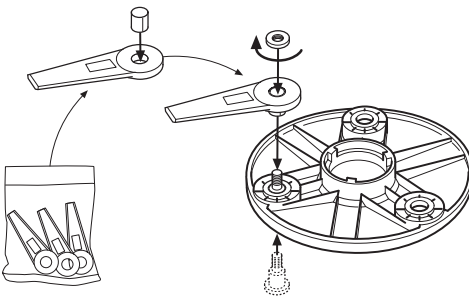

7

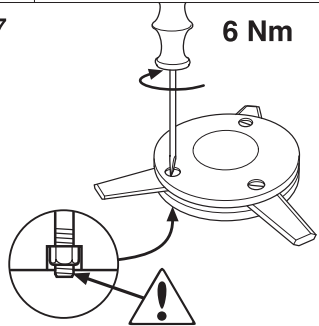

8

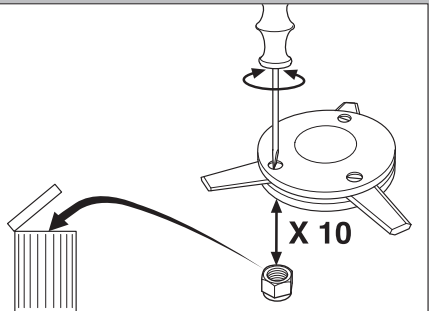
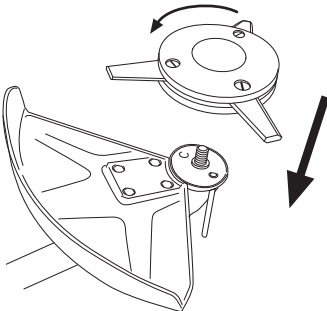



S35



1

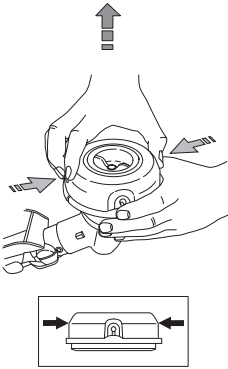

2

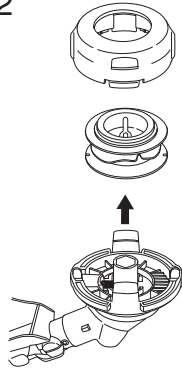

3

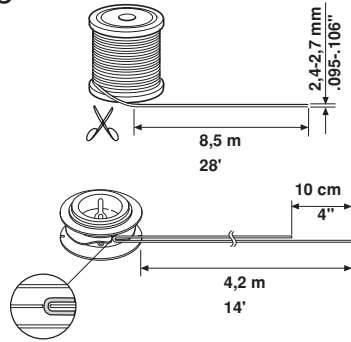

4

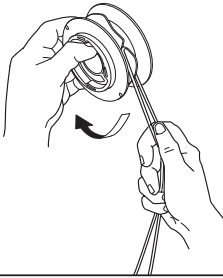

5

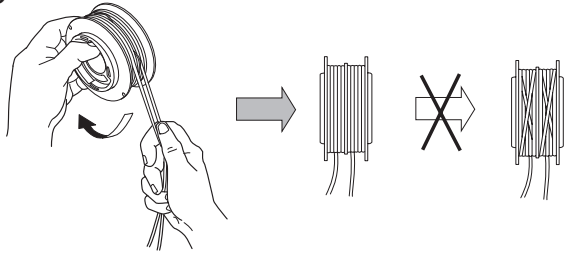

6

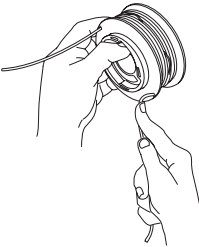

7

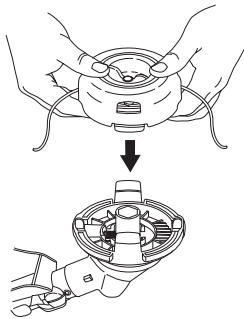

8

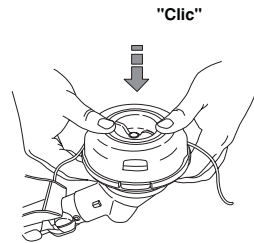

10

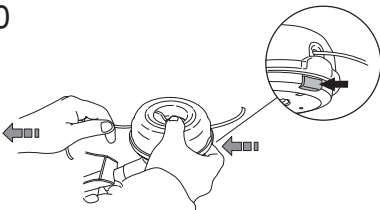

11

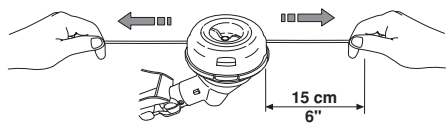

S35



1

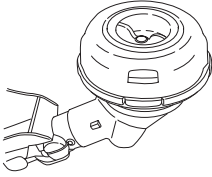

2

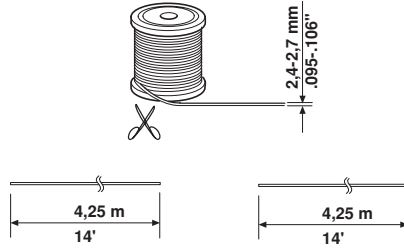

3

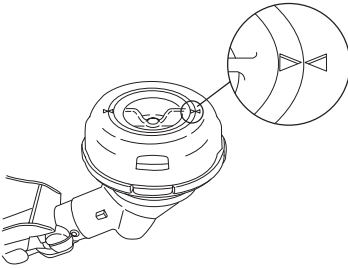

4

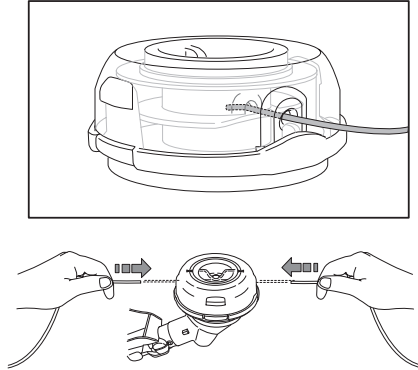

5

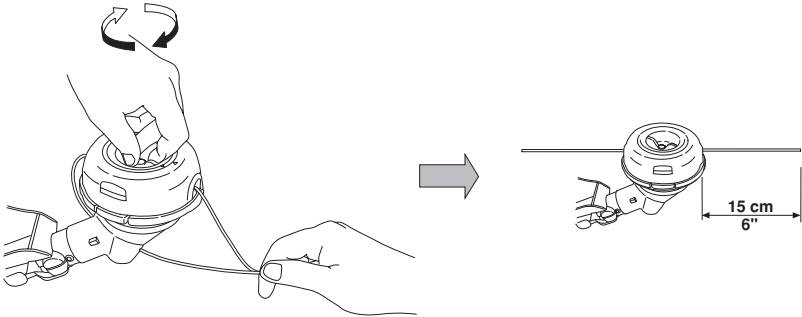

A

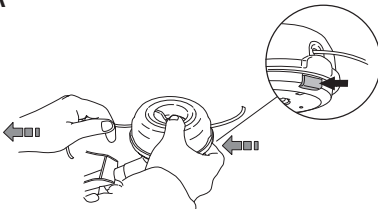

B

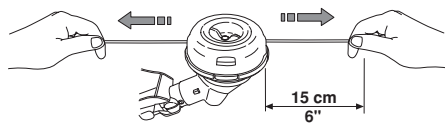

# T35, T35x



1

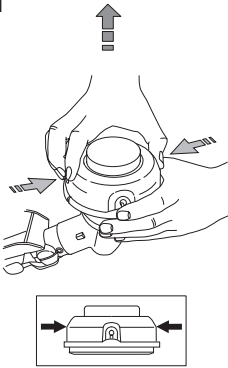

2

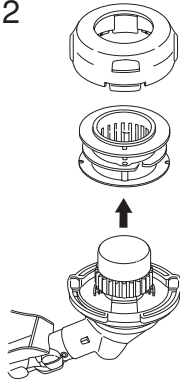

3

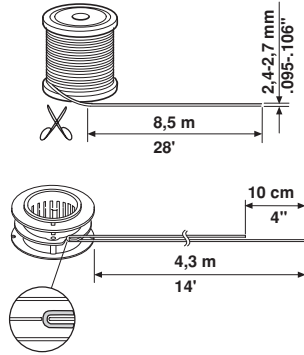

4

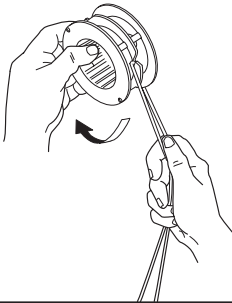

5

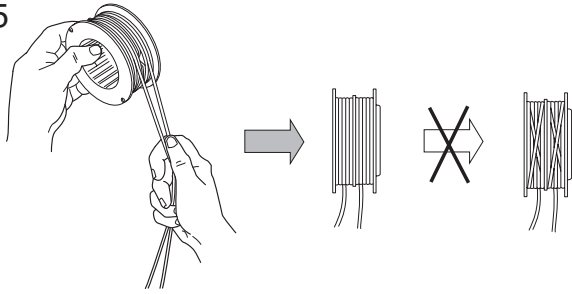

6

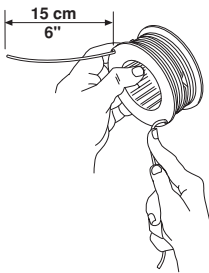

7

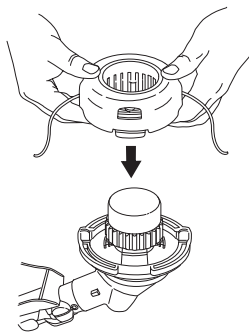

8

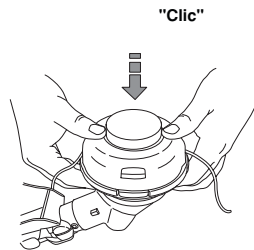

9

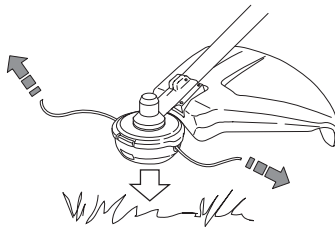

**Original instructions**

**1153287-26**



**2010-03-30**