

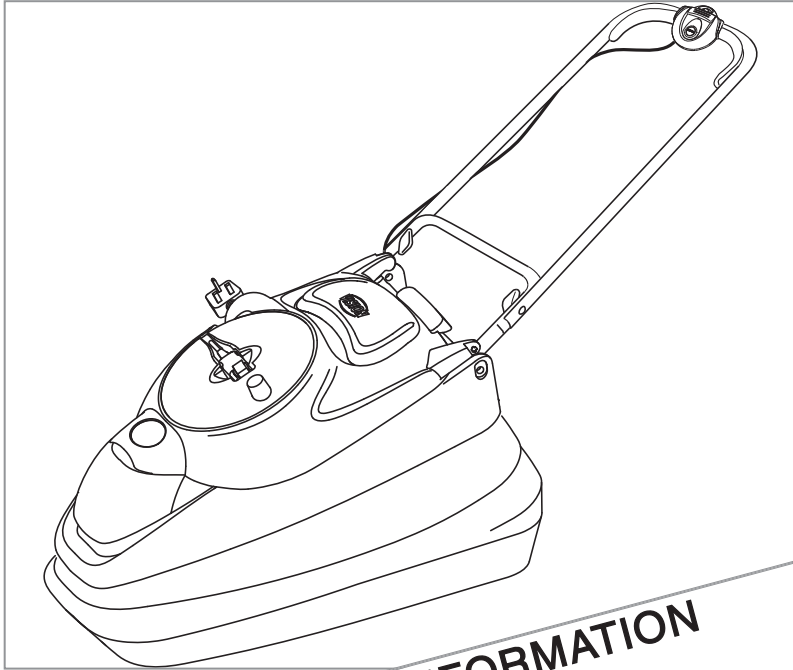



Vision Compact 330/350/380

 Original Instructions



 **IMPORTANT INFORMATION**
Read before use
& retain for future reference

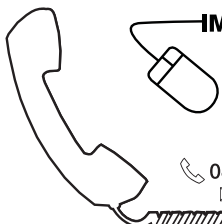

IMPORTANT Please register your product warranty on line.

To register your warranty and for all your parts requirements please visit

www.flymo.com

For all other enquiries

0844 844 4558 **UK** 1800 882 350 **ROI**

 customer.services@husqvarna.co.uk

Carton Contents

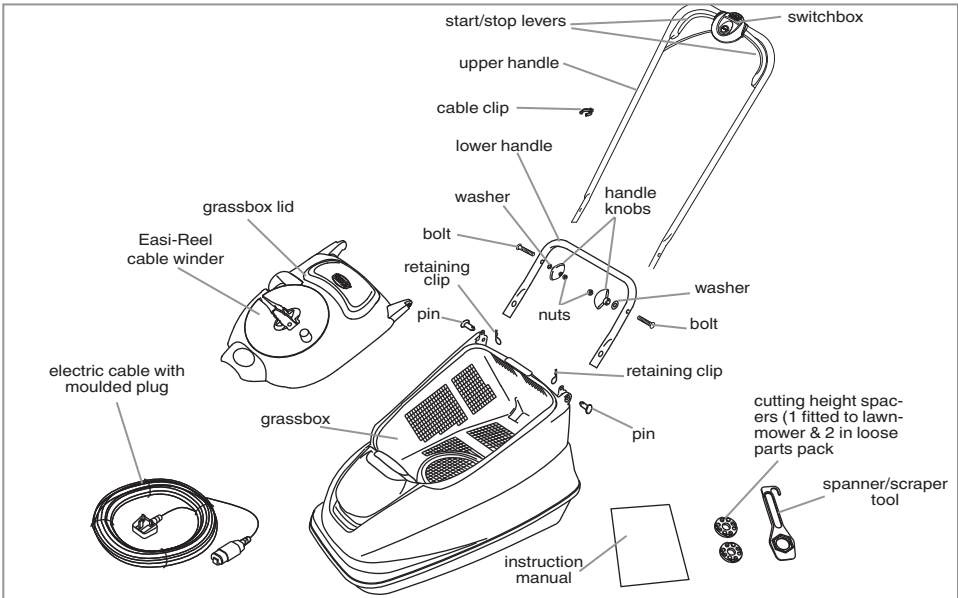

IMPORTANT!

Please check the contents of the carton are correct **BEFORE** assembling your new Flymo product.
IF ANY PARTS ARE MISSING CONTACT:- Husqvarna UK Ltd. Customer Service Department direct
 Telephone : 0844 844 4558 **UK** 1800 882 350 **ROI** Fax : 01325 302530

Safety



If not used properly this lawnmower can be dangerous! This lawnmower can cause serious injury to the operator and others, the warnings and safety instructions must be followed to ensure reasonable safety and efficiency in using this lawnmower. The operator is responsible for following the warning and safety instructions in this manual and on the lawnmower. Never use the mower unless the grassbox or guards provided by the manufacturer are in the correct position.



Explanation of Symbols on your product

Warning



Read the user instructions carefully to make sure you understand all the controls and what they do.



Always keep the lawnmower on the ground when mowing. Tilting or lifting the lawnmower may cause stones to be thrown out



Keep bystanders away. Do not mow whilst people especially children or pets are in the mowing area



Beware of sharp blades - remove plug from mains before maintenance or if cable is damaged.



Blades continue to rotate after the machine is switched off.



Keep the cable supply away from the blade.

General

- This product is not intended for use by persons (including children) with reduced physical, sensory or mental capabilities, or lack of experience and knowledge, unless they have been given supervision or instruction concerning the use of the product by a person responsible for their safety. Children should be supervised to ensure that they do not play with the product. Local regulations may restrict the age of the operator.
- Never allow children or people unfamiliar with the instructions to use the machine.
- Stop using the machine while people, especially chil-

dren, or pets are nearby.

- Only use the lawnmower in the manner and for the functions described in these instructions.
- Never operate the lawnmower when you are tired, ill or under the influence of alcohol, drugs or medicine.
- The operator or user is responsible for accidents or hazards occurring to other people or their property.

Electrical

- The British Standards Institute recommend the use of a Residual Current Device (R.C.D.) with a tripping current of not more than 30mA. Even with a R.C.D. installed 100% safety cannot be guaranteed and safe

- working practice must be followed at all times. Check your R.C.D. every time you use it.
2. Before use, examine cable for damage, replace it if there are signs of damage or ageing.
 3. Do not use the lawnmower if the electric cables are damaged or worn
 4. Immediately disconnect from the mains electricity supply if the cable is cut, or the insulation is damaged. Do not touch the electric cable until the electrical supply has been disconnected. Do not repair a cut or damaged cable. Replace it with a new one.
 5. Your extension cable must be unwound, wound cables can overheat and reduce the efficiency of your mower.
 6. Keep cable away from lawnmower, always work away from the power point mowing up and down, never in circles.
 7. Do not pull cable around sharp objects.
 8. Always switch off at the mains before disconnecting any plug, cable connector or extension cable.
 9. Switch off, remove plug from mains and examine electric supply cable for damage or ageing **before** winding cable for storage. Do not repair a damaged cable, replace it with a new one. Use only Flymo replacement cable.
 10. Always wind cable carefully, avoiding kinking.
 11. Never carry the product by the cable.
 12. Never pull on the cable to disconnect any of the plugs.
 13. Use only on AC mains supply voltage shown on the product rating label.
 14. Our products are double insulated to EN60335. Under no circumstance should an earth be connected to any part of the product.

Preparation

1. While using your product, always wear substantial footwear and long trousers.
2. Make sure the lawn is clear of sticks, stones, bones, wire and debris; they could be thrown by the blade.
3. Before using the machine and after any impact, check for signs of wear or damage and repair as necessary.
4. Replace worn or damaged blades together with their fixings in sets to preserve balance.

Use

1. Use the lawnmower only in daylight or good artificial light.
2. Avoid operating your lawnmower in wet grass, where feasible.
3. Take care in wet grass, you may lose your footing.
4. On slopes, be extra careful of your footing and wear non-slip footwear.

5. Mow across the face of slopes, never up and down.
6. Exercise extreme caution when changing direction on slopes. Walk never run.
7. Mowing on banks and slopes can be dangerous. Do not mow on **banks** or **steep** slopes.
8. Do not walk backwards when mowing, you could trip.
9. Never cut grass by pulling the mower towards you.
10. Switch off before pushing the mower over surfaces other than grass.
11. Never operate the lawnmower with damaged guards or without guards in place.
12. Keep hands and feet away from the blade at all times and especially when switching on the motor.
13. Do not tilt lawnmower when the motor is running, except when starting and stopping. In this case, do not tilt more than absolutely necessary and lift only the part which is away from the operator. Always ensure that both hands are in the operating position before returning the appliance to the ground.
14. Never pick up or carry a mower when it is operating or still connected to the mains supply.
15. Remove the plug from the mains :
 - before leaving the mower unattended for any period;
 - before clearing a blockage;
 - before checking, cleaning or working on the appliance;
 - if you hit an object. Do not use your lawnmower until you are sure that the entire lawnmower is in a safe operating condition;
 - if the lawnmower starts to vibrate abnormally. Check immediately. Excessive vibration can cause injury.

Maintenance and storage

1. Caution - Do not touch rotating blade.
2. Keep all nuts, bolts and screws tight to be sure the lawnmower is in safe working condition.
3. Check the grassbox/grassbag frequently for wear or deterioration.
4. Replace worn or damaged parts for safety.
5. Only use the replacement blade, blade bolt, spacer and impeller specified for this product.
6. Be careful during adjustment of the lawnmower to prevent entrapment of the fingers between moving blades and fixed parts of the machine.
7. Store in a cool dry place and out of reach of children. Do not store outdoors.
8. Allow the product to cool for atleast 30 minutes before storing.

Cables

CABLES

IMPORTANT

- Use only 1.00mm² size cable up to 40 metres length maximum.

Maximum rating: 1.00mm² size cable, 10 amps 250 volts AC.

• THE VISION COMPACT IS SUPPLIED WITH AN ELECTRIC MAINS CABLE FITTED WITH A FEMALE CONNECTOR

1. Flymo Mains Cables and Extension Cables are available from your local Approved Service Centre.
2. Do not wire an extension cable directly to your product yourself. Please contact your local Approved Service Centre for further information on the connectors and kits available.
3. Only use extension cables specifically designed for outdoor use.

CONNECTORS

IMPORTANT

- Flymo connectors are suitable for use with 2 core cable only. Under no circumstances should these connectors be used for earthed products.
- All Flymo connectors and cables are of splashproof construction. They are not waterproof and must not be left outside permanently nor should they be submerged or immersed in water. Do not let cable lay or trail through pools of water or splashed with water from hose pipes.

MAINS PLUG REPLACEMENT

IMPORTANT

- **If the plug supplied is cut off it should be destroyed. There is an electric shock hazard if a cut off plug is inserted into a 13 amp socket.**

1. **No earth required.** Flymo products are double insulated to EN60335 and under no circumstances should an earth be connected to any part of the product.

2. Ensure the mains voltage suits your product

3. IMPORTANT

The wires in the mains lead are coloured in accordance with the following code:

BLUE - NEUTRAL

BROWN - LIVE

The wire which is coloured BLUE must be connected to the Terminal which is marked with the letter 'N' or coloured BLACK.

The wire which is coloured BROWN must be connected to the Terminal which is marked with the letter 'L' or coloured RED.

4. It is important that the outer sheath is clamped correctly into the 3-pin plug.
5. If in doubt consult your local Service Repairer or qualified electrician before the machine is used.
6. **A 13 Amp fuse must be fitted to the Mains Plug.**
7. The normal plug fuse and household fuse only protect the electrical equipment and are not a safeguard against electrocution.

Assembly Instructions

Lower handle assembly (A)

1. Insert the lower handle into the handle slots, ensuring that the holes are aligned.
2. Insert the pins and secure with the retaining clips.

Upper handle assembly (B)

1. Insert the nut into the handle knob. **(B1)**
2. Align the holes in the upper and lower handles and secure with the bolt, washer and wing knob. **(B2)**
3. Fit the cable to the handle with the clip provided. **(B3)** Make sure the cable is not trapped between the upper and lower handles.

Grassbox lid assembly (C)

1. Fit one side of the grassbox lid as illustrated in **Fig. C**. Repeat for the other side.

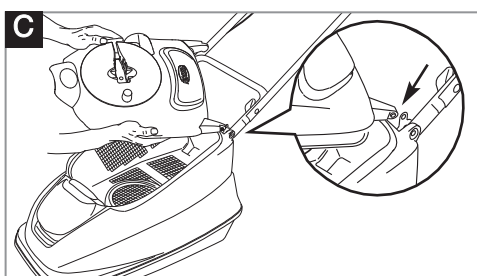
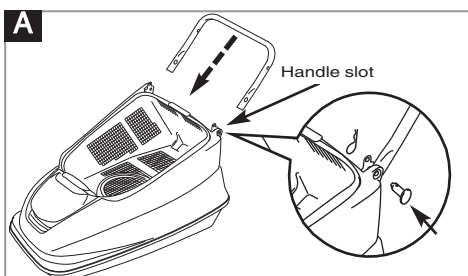
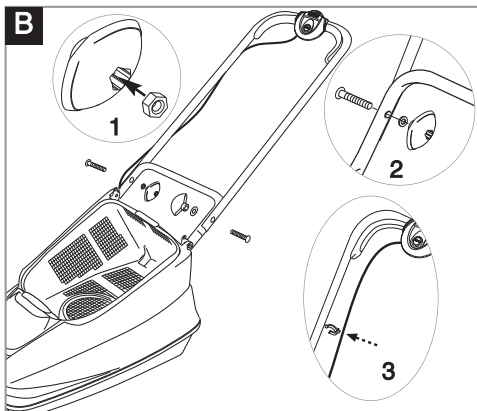

Starting and Stopping

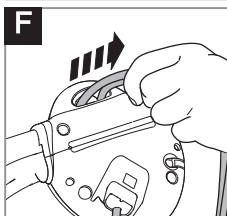
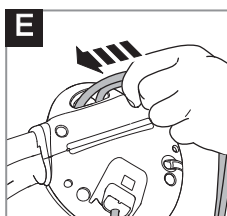
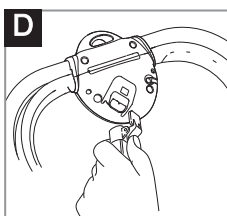

To Start your Lawnmower

The Flymo Vision Compact uses an advanced belt drive system, between the motor and the blade which improves cutting power and flotation in all conditions. Due to the high turning force (Torque) which this motor develops a light squeak may be heard when the machine is started, this is quite normal and will not affect the performance of the product

1. Connect female extension cable connector to the back of the switchbox. **(D)**
2. Form loop in mains cable and push the loop through the slot as illustrated in picture **(E)**
3. To secure, position loop over the hook and pull the cable back through the slot as illustrated in picture **(F)**.
4. Connect plug to mains and switch on.
5. To prevent a ring being cut in your lawn and to clear any residual grass in the collection chute, tilt your lawnmower slightly **(G)**.

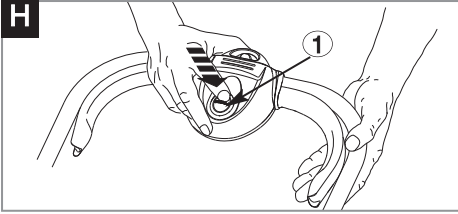

The switchbox is provided with a lock-off button (H1) to prevent accidental starting.

6. Press and hold the lock-off button (H) on the switchbox, then squeeze one of the Start/Stop levers towards the upper handle (J).
7. Continue to squeeze the start/stop lever towards the upper handle and release the lock-off button.
8. When the lawnmower has reached full speed gently lower it onto the lawn.

NOTE: There are two start/stop levers fitted. Either one can be used for starting the lawnmower.

IMPORTANT: Do not use the start/stop levers intermittently

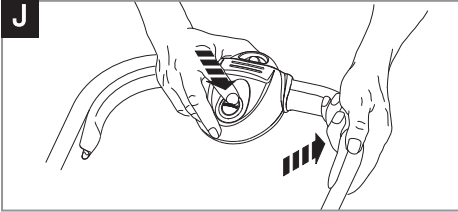

To Stop your Lawnmower

1. To prevent a ring being cut in your lawn and to clear any residual grass in the collection chute, tilt your lawnmower slightly (H).
2. Release the pressure on the Start/Stop lever.

How to Mow

1. Start mowing the edge of the lawn nearest to the power point so the cable is laid out on the lawn you have already cut.
2. Mow twice a week during the growing season, your lawn will suffer if more than a third of its length is cut at one time and this may also result in poor collection.

Do Not Overload Your Mower

Mowing long thick grass may cause the motor speed

to drop, you will hear a change in the motor sound. If the motor speed drops you may overload your lawnmower which may cause damage. When mowing in long thick grass a first cut with the cutting height set higher will help reduce the load. See Adjusting the Cutting Height.

REMEMBER: For best grass collection always mow in a straight line, do not swing the lawnmower from side to side.

Adjusting the Cutting Height

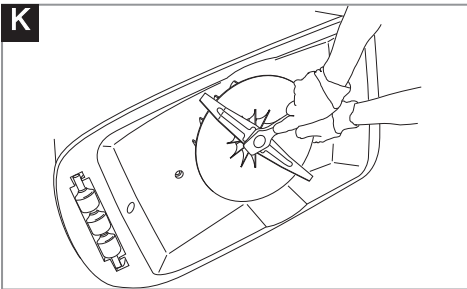

Always handle the blade with care - sharp edges could cause injury. **USE GLOVES.** Never use more than 3 Cutting Height Spacers. Spacers must only be fitted between the blade and the fan and **NEVER** between the blade and the bolt.

1. Remove the blade bolt, and blade as described in **Removing the Blade and Fan.**
2. **For a Lower Cut** - Add spacers to a maximum of 3.
3. **For a Higher Cut** - Take spacers away.
4. Refit the blade as described in **Fitting the Blade and Fan.**

Removing and fitting the Blade and Fan

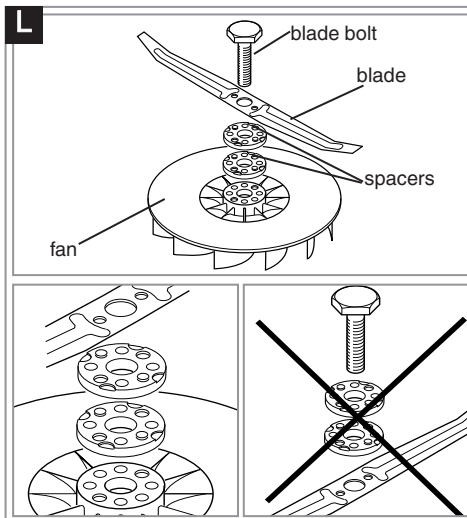

Removing the Blade and Fan

1. To remove the blade bolt, hold the fan firmly and with the spanner provided loosen the blade bolt by turning it anti-clockwise (K).
2. Remove the blade bolt, blade, spacers and fan. (L)
3. Inspect for damage and clean as necessary.
 - **Renew your metal blade after 50 hours mowing or 2 years whichever is the sooner - regardless of condition.**
 - **If the blade is cracked or damaged replace it with a new one.**
 - **Never use a blade bolt if the insulated head is damaged cracked or missing.**

Fitting the Blade and Fan

1. Ensure the fan is located correctly. (L)
2. Place the spacers onto the fan ensuring the pegs have located into the holes. (L)
3. Place the blade onto the spacers ensuring the pegs have located into the holes on the blade and ensuring the blades is positioned as illustrated in **Figure L**.
4. Place the blade bolt through the centre hole of the blade.
5. Tighten down clockwise by hand.
6. Hold the fan firmly and tighten the blade bolt with the spanner provided.

Removing, Emptying and Refitting the Grassbox

Grassbox Full

- As the grassbox fills up, grass will be clearly visible through the window in the lid (M).
- When the window is full it is time to empty the grassbox.

Emptying the Grassbox

- **Stop the lawnmower, as described in 'To Stop your Lawnmower' and wait until the blade has stopped rotating, BEFORE lifting the grassbox lid.**
1. Lift the grassbox lid and rest against the handles (N).
 2. Remove the grassbox using the moulded handle recesses as illustrated. (See Figure P).
 3. Empty grassbox.
 4. Replace grassbox and lid carefully.
- **Failure to fit the grassbox and grassbox lid correctly will cause poor collection of grass clippings.**

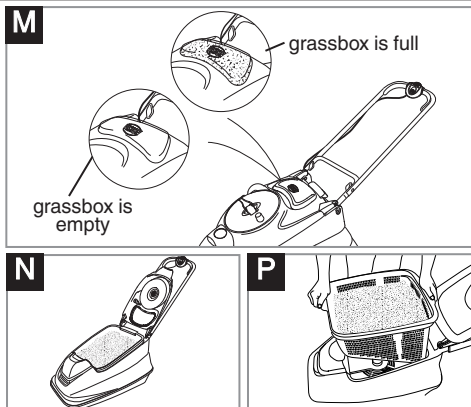

Easi-Reel Cable Winder

Storing your cable in the Easi-Reel cable winder

1. Insert the female connector into the top of the cable winder (R1)
2. Place the cable under the cable guide (R2)
3. Turn the cable winder (R3) until all of the cable is wound in. (R4)

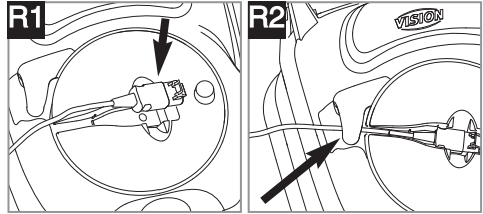

Warning:- When cable is fully wound, lid becomes heavy

Unwinding the cable before re-use

1. Pull the cable by the plug and unwind the cable fully.
- Ensure that the cable is released from the cable guide (R2) before using your machine.

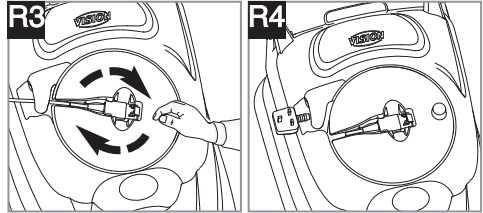

Caring for your Lawnmower

Cleaning

IMPORTANT: It is very important that you keep your lawnmower clean. Grass clippings left in any of the air intakes or under the hood could become a potential fire hazard. **USE GLOVES**

It is recommended that you clean your lawnmower straight after mowing while the grass is still wet.

1. Remove grass from under the hood with the spanner/scrapper tool. (S)
2. Remove the blade, see Figure L, to gain access to the fan and clean with a soft brush. (S)
3. Lever the roller out of position and clean with a soft brush. (S)
4. Remove grass clippings from:
 - all air intakes (T)
 - grassbox (U)
5. Thoroughly clean the inside of the window with a soft brush (V).
6. Wipe over the surface of your lawnmower with a dry cloth. (W)

• IMPORTANT

Never use water for cleaning your lawnmower. Do not clean with chemicals, including petrol, or solvents - some can destroy critical plastic parts.

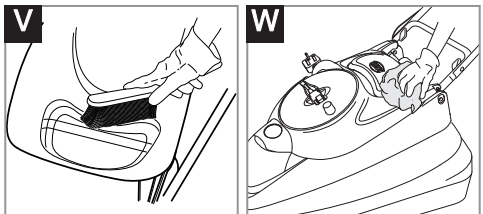
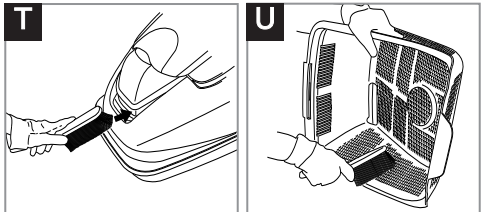
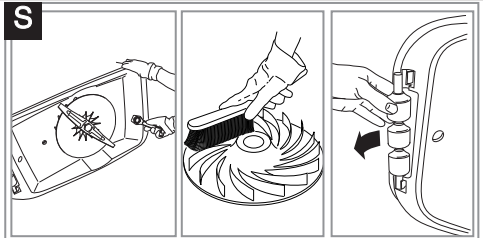

Cleaning the Easi-Reel cable winder

1. Lift grassbox lid, squeeze together the two catches (X1) and remove the cable winder.
2. Clean the cable winder and the area it was located with a soft brush (X2 & X3)
3. Replace the cable winder, ensuring it clicks into place.

At the End of the Mowing Season

1. Replace blade, bolts, nuts or screws, if necessary.
2. Clean your lawnmower thoroughly.
3. Ask your local Service Centre to clean the air filter thoroughly and carry out any service or repairs required.
4. Make sure that the electric cable is wound properly.

Transporting and Storing the lawnmower

The handles can be folded to take up the minimum of space (Y)

- Loosen the handle knobs.
- Fold the upper handle over the lawnmower.
- Ensure the switchbox cable is not trapped.
- The Vision Compact lawnmower may be transported on its roller (Z)
- Store in a dry place where your lawnmower is protected from damage.

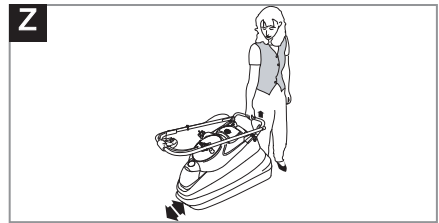
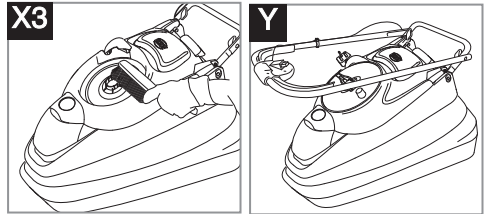
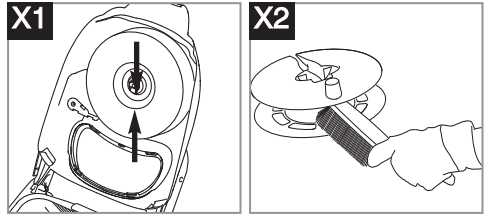

Fault Finding Hints

Fails to Operate

1. Is the correct Starting procedure being followed?
See 'To Start your Lawnmower'
2. Is the Power Turned On?
3. Check the fuse in the plug, if blown replace.
4. Fuse continues to blow?
Immediately disconnect from the mains electricity supply and consult your local approved Service Centre.

Poor Flotation

1. Disconnect from the mains electricity supply.
2. Clean the underside of the hood and the fan blades.
3. Raise to a higher height of cut. See 'Adjusting the Cutting Height'.
4. If poor flotation persists?
Disconnect from the mains electricity supply and consult your local approved Service Centre.

Poor Collection

1. Is the grassbox lid firmly closed?
2. Is the grassbox fitted correctly?
3. Are you mowing correctly?
4. Check all air vents and openings are not obstructed.
5. Raise to a higher height of cut. See 'Adjusting the Cutting Height'.
6. If poor collection persists.
Disconnect from the mains electricity supply and consult your local approved Service Centre.

Excessive Vibration

1. Disconnect from the mains electricity supply.
2. Check that the blade is fitted correctly?
3. If the blade is damaged or worn, replace it with a new one.
4. If vibration persists?
Immediately disconnect from the mains electricity supply and consult your local approved Service Centre.

Replacement Parts

Blade

330	Reference no.:	FLY007	Part no.:	511835790
350	Reference no.:	FLY008	Part no.:	512733490
380	Reference no.:	FLY009	Part no.:	511843690

Guarantee & Guarantee Policy

If any part is found to be defective due to faulty manufacture within the guarantee period, Husqvarna UK Ltd., through its Authorised Service Repairers will effect the repair or replacement to the customer free of charge providing:

- (a) The fault is reported directly to the Authorised Repairer.
- (b) Proof of purchase is provided.
- (c) The fault is not caused by misuse, neglect or faulty adjustment by the user.
- (d) The failure has not occurred through fair wear and tear.
- (e) The machine has not been serviced or repaired, taken apart or tampered with by any person not authorised by Husqvarna UK Ltd..
- (f) The machine has not been used for hire.
- (g) The machine is owned by the original purchaser.
- (h) The machine has not been used commercially.

* This guarantee is additional to, and in no way Failures due to the following are not covered, therefore it is important that you read the instructions contained in this Operator's Manual and understand how to operate and maintain your machine:

Failures not covered by guarantee

- * Replacing worn or damaged blades
- * Failures as a result of not reporting an initial fault.
- * Failures as a result of sudden impact.
- * Failures as a result of not using the product in accordance with the instructions and recommendations contained in this Operator's Manual.
- * Machines used for hire are not covered by this guarantee.
- * The following items listed are considered as wearing parts and their life is dependent on regular maintenance and are, therefore not normally subject to a valid warranty claim: Blade, Electric Mains cable, belt
- * **Caution!**
Husqvarna UK Ltd. does not accept liability under the warranty for defects caused in whole or part, directly or indirectly by the fitting of replacement parts or additional parts that are not either manufactured or approved by Husqvarna UK Ltd., or by the machine having been modified in any way.

Service Recommendations

1. We strongly recommend that your product is serviced at least every twelve months, more often in a professional application.
2. Always use genuine Flymo Spare Parts.
3. Prepacked spares are available from most Husqvarna UK Ltd. stockists.
4. Your product is uniquely identified by a silver and black product rating label
5. If you have a problem with your machine contact your local Approved Service Centre ensuring you have full details of your product as described on the product rating label.
6. **Should it be necessary for work to be carried out by your Service Centre, it is important to take your complete machine including cable and any extension cables used.**

A network of specialist dealers can be found in your local

Yellow Pages.

To obtain service on your Flymo product simply telephone or visit your local Service Centre.

Should you require service under the terms of our guarantee the Service Centre will require proof of purchase.

All of the centres listed stock genuine Flymo Spare Parts. NOTE: Our Service Repairers act on their own behalf and are not empowered to commit or legally bind Husqvarna UK Ltd. in any manner whatsoever.

Environmental Information

Husqvarna UK Ltd. are manufactured under an Environmental Management System (ISO 14001) using, where practical, components manufactured in the most environmentally responsible manner, according to company procedures, and with the potential for recycling at the end of the products' life.

- Packaging is recyclable and plastic components have been labelled (where practical) for categorised recycling.
- Awareness of the environment must be considered when disposing of 'end-of-life' product.
- If necessary, contact your local authority for disposal information.



The symbol  on the product or on its packaging indicates that this product may not be treated as household waste. Instead it shall be handed over to the applicable collection point for the recycling of electrical and electronic equipment.

By ensuring this product is disposed of correctly, you will help prevent potential negative consequences for the environment and human health, which could otherwise be caused by inappropriate waste handling of this product.

For more detailed information about recycling of this product, please contact your local council office, your household waste disposal service or the shop where you purchased the product.

EC Declaration of Conformity

Husqvarna AB, 561 82, Huskvarna, Sweden
 Declare under our sole responsibility that the product(s);

Category..... **Electric Rotary Lawnmower**
 Model(s)..... **VC330, VC350, VC380**
 Identification of Series..... **See Product Rating Label**
 Year of Construction..... **See Product Rating Label**

Complies with the essential requirements & provisions of the following EC Directives:
98/37/EC (until 28.12.09), 2006/42/EC (from 29.12.09), 2004/108/EC, 2000/14/EC
 based on the following EU harmonized standards applied:

EN60335-1, EN60335-2-77, EN836, EN55014-1, EN61000-3-2, EN61000-3-3, EN50366

The maximum A weighted sound pressure level L_{pA} at the operator's position, recorded on a sample of the above product(s) corresponds to the **Level** given in the table.

The maximum hand / arm vibration weighted value measured according to EN ISO 5349 on a sample of the above product(s) corresponds to the **Value a_h** given in the table.

2000/14/EC: The Measured Sound Power L_{WA} & Guaranteed Sound Power L_{WA} values are according to the tabulated figures.

Conformity Assessment Procedure..... Annex VI
 Notified Body..... Intertek, Cleeve Road
 Leatherhead, Surrey
 KT22 7SB, England

Newton Aycliffe, 25/11/2009
 M. Bowden,
 Research & Development Director
 Husqvarna UK Ltd.
 Keeper of technical documentation



Type	VC330	VC350	VC380
Width of Cut (cm)	33	35	38
Speed of Rotation of Cutting Device (RPM)	4,300	4,300	4,350
Power (kW)	1.5	1.55	1.7
Measured Sound Power LWA (dB(A))	92	91	89
Guaranteed Sound Power LWA (dB(A))	93	94	90
Level (dB(A))	78.8	78.8	79.1
Value a_h (m/s ²)	1.64	1.64	2.97
Uncertainty K of a_h (m/s ²)	1.5	1.5	1.5
Weight (Kg)	10.5	10.5	11

Our policy of continuous improvement means that the specification of products may be altered from time to time without prior notice.
 Copyright © 2008 Flymo S.A. All rights reserved. Flymo® and other product and feature names are registered or unregistered trademarks of Flymo S.A.

Husqvarna AB
 561 82
 Huskvarna
 Sweden

5119593-06

