



EasiCut 420/EasiCut 450/
EasiCut 500/EasiCut 510
EasiCut 600XT



Original Instructions

EasiCut 420/450/500/510

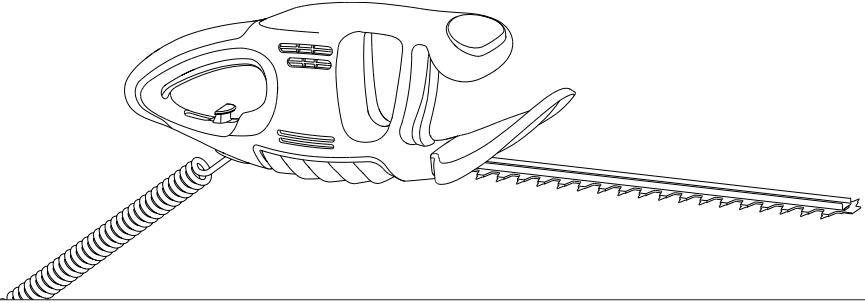

EasiCut 600XT

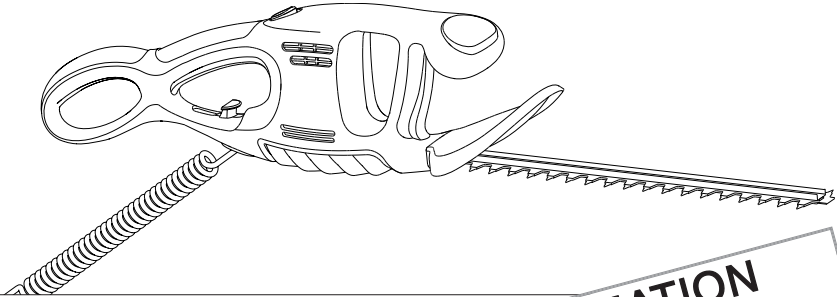

IMPORTANT INFORMATION
Read before use
& retain for future reference

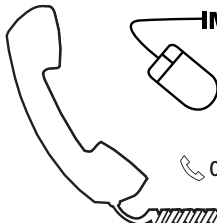

IMPORTANT Please register your product warranty on line.

To register your warranty and for all your parts requirements please visit

www.flymo.com

For all other enquiries

☎ 0844 844 4558 **UK** 1800 882 350 **ROI**

✉ customer.services@husqvarna.co.uk

Carton Contents

EasiCut 420/450/500/510

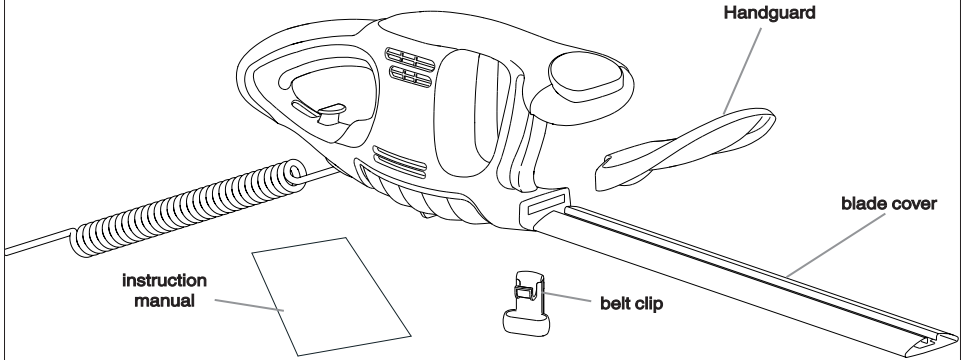

EasiCut 600XT

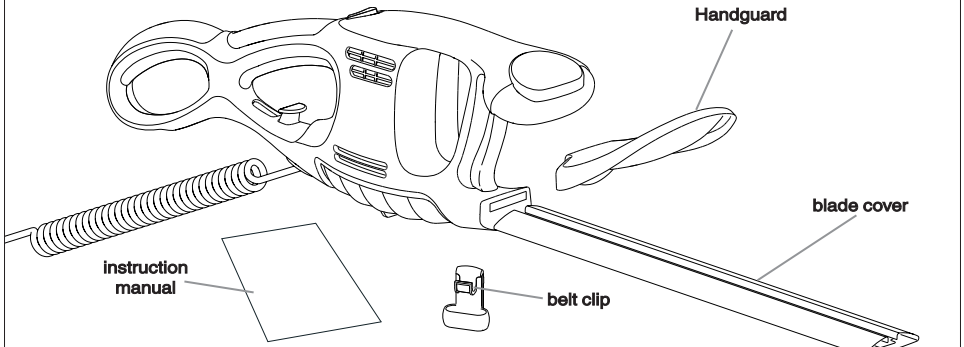
**IMPORTANT!**

Please check the contents of the carton are correct **BEFORE** assembling your new product.

IF ANY PARTS ARE MISSING CONTACT:-

Husqvarna UK Ltd. Customer Service Department direct

Telephone : 0844 844 4558 UK 1800 882 350 ROI Fax : 01325 302530

Safety



If not used properly this product can be dangerous! This product can cause serious injury to the operator and others, the warnings and safety instructions must be followed to ensure reasonable safety and efficiency in using this product. The operator is responsible for following the warning and safety instructions in this manual and on the product.

Explanation of Symbols on your product



Warning.



Read the user instructions carefully to make sure you understand all the controls and what they do.



Remove plug from the mains immediately if the cable is damaged or cut.



Do not expose to rain.
Do not leave the product outdoors while it is raining.



The use of eye protection is recommended.

General Power Tool Safety Warnings

WARNING Read all safety warnings and all instructions. Failure to follow the warnings and instructions may result in electric shock, fire and/or serious injury.

Save all warnings and instructions for future reference. The term "power tool" in the warnings refers to your mains-operated (corded) power tool or battery-operated (cordless) power tool.

1) Work area safety

- Keep work area clean and well lit. Cluttered or dark areas invite accidents.
- Do not operate power tools in explosive atmospheres, such as in the presence of flammable liquids, gases or dust. Power tools create sparks which may ignite the dust or fumes.
- Keep children and bystanders away while operating a power tool. Distractions can cause you to lose control.

2) Electrical safety

- Power tool plugs must match the outlet. Never modify the plug in any way. Do not use any adaptor plugs with earthed (grounded) power tools. Unmodified plugs and matching outlets will reduce risk of electric shock.
- Avoid body contact with earthed or grounded surfaces, such as pipes, radiators, ranges and refrigerators. There is an increased risk of electric shock if your body is earthed or grounded.
- Do not expose power tools to rain or wet conditions. Water entering a power tool will increase the risk electric shock.
- Do not abuse the cord. Never use the cord for carrying, pulling or unplugging the power tool. Keep cord away from heat, oil, sharp edges or moving parts. Damaged or entangled cords increase the risk of electric shock.
- When operating a power tool outdoors, use an extension cord suitable for outdoor use. Use of a cord suitable for outdoor use reduces the risk of electric shock.
- If operating a power tool in a damp location is unavoidable, use a residual current device (RCD) protected supply. Use of an RCD reduces the risk of electric shock.

3) Personal safety

- Stay alert, watch what you are doing and use common sense when operating a power tool. Do not use a power tool while you are tired or under the influence of drugs, alcohol or medication. A moment of inattention while operating power tools may result in serious personal injury.
- Use personal protective equipment. Always wear eye protection. Protective equipment such as dust mask, non-skid safety shoes, hard hat, or

hearing protection used for appropriate conditions will reduce personal injuries.

- Prevent unintentional starting. Ensure the switch is in the off-position before connecting to power source and/or battery pack, picking up or carrying the tool. Carrying power tools with your finger on the switch or energising power tools that have the switch on invites accidents.
 - Remove any adjusting key or wrench before turning the power tool on. A wrench or a key left attached to a rotating part of the power tools may result in personal injury.
 - Do not overreach. Keep proper footing and balance at all times. This enables better control of the power tool in unexpected situations.
 - Dress properly. Do not wear loose clothing or jewellery. Keep your hair, clothing and gloves away from moving parts. Loose clothes, jewellery or long hair can be caught in moving parts.
 - If devices are provided for the connection of dust extraction and collection facilities, ensure these are connected and properly used. Use of dust collection can reduce dust-related hazards.
- ### 4) Power tool use and care
- Do not force the power tool. Use the correct power tool for your application. The correct power tool will do the job better and safer at the rate for which it was designed.
 - Do not use the power tool if the switch does not turn it on and off. Any power tool that cannot be controlled with the switch is dangerous and must be repaired.
 - Disconnect the plug from the power source and/or the battery pack from the power tool before making any adjustments, changing accessories, or storing power tools. Such preventive safety measures reduce the risk of starting the power tool accidentally.
 - Store idle power tools out of the reach of children and do not allow persons unfamiliar with the power tool or these instructions to operate the power tool. Power tools are dangerous in the hands of untrained users.
 - Maintain power tools. Check for misalignment or binding of moving parts, breakage of parts and any other condition that may affect the power tool's operation. If damaged, have the power tool repaired before use. Many accidents are caused by poorly maintained power tools.
 - Keep cutting tools sharp and clean. Properly maintained cutting tools with sharp cutting edges are less likely to bind and are easier to control.
 - Use the power tool, accessories and tool bits etc. in accordance with these instructions, taking into account the working conditions

Safety cont'

and the work to be performed. *Use of the power tool for operations different from those intended could result in a hazardous situation.*

5. Service

- a) **Have your power tool serviced by a qualified repair person using only identical replacement parts.** *This will ensure that the safety of the power tool is maintained.*

Hedge trimmer safety warnings:

- **Keep all parts of the body away from the cutter blade. Do not remove cut material or hold material to be cut when blades are moving. Make sure the switch is off when clearing jammed material.** *A moment of inattention while operating the hedge trimmer may result in serious personal injury.*
- **Carry the hedge trimmer by the handle with the cutter blade stopped. When transporting or storing the hedge trimmer always fit the cutting device cover.** *Proper handling of the hedge trimmer will reduce possible personal injury from the cutter blades.*
- **Hold the power tool by insulated gripping surfaces only, because the cutter blade may contact hidden wiring or its own cord.** *Cutter blades contacting a "live" wire may make exposed metal parts of the power tool "live" and could give the operator an electric shock.*
- **Keep cable away from the cutting area.** *During operation the cable may be hidden in shrubs and can be accidentally cut by the blade.*

Additional Safety Recommendations

Work area safety

1. Never allow children or people unfamiliar with these instructions to use the hedge trimmer. Local regulations may restrict the age of the operator.
2. Only use the hedge trimmer in the manner and for the functions described in these instructions.
3. The operator or user is responsible for accidents or hazards occurring to other people or their property.

Electrical safety

1. It is recommended that you use a Residual Current Device (R.C.D.) with a tripping current of not more than 30mA. Even with a R.C.D. installed 100% safety cannot be guaranteed and safe working practice must be followed at all times. Check your R.C.D. every time you use it.
2. Before use, examine the cable for signs of damage or ageing. If the cable is found to be defective, take the product to an Authorised Service Centre and have the cable replaced.
3. Do not use the hedge trimmer if the electric cables are damaged or worn.
4. Immediately disconnect from the mains electricity supply if the cable is cut, or the insulation is damaged. Do not touch the electric cable until the electrical supply is disconnected. Do not repair a cut or damaged cable, replace it with a new one. If replacement of the cable is necessary, this must only be done by an Approved Service Centre in order to

avoid a safety hazard.

5. Your electric cable must be untangled, tangled cables can overheat and reduce the efficiency of your hedge trimmer.
6. Always switch off at the mains before disconnecting any plug, cable connector or extension cable.
7. Switch off, remove plug from mains and examine electric supply cable for damage or ageing **before** winding cable for storage.
8. Always wind cable carefully, avoiding kinking.
9. Use only on AC mains supply voltage shown on the product rating label.
10. Our products are double insulated to EN60745. Under no circumstances should an earth be connected to any part of the product.

Personal safety

1. Always wear suitable clothing, gloves, and stout shoes.
2. Thoroughly inspect the area where the hedge trimmer is to be used and remove all wires and other foreign objects.
3. Before using the machine and after any impact, check for signs of wear or damage and repair as necessary.
4. Always ensure the hand guard supplied is fitted before using the hedge trimmer. Never attempt to use an incomplete hedge trimmer or one with an unauthorised modification.

Power tool use and care

1. Know how to stop the hedge trimmer quickly in an emergency.
2. Never hold the hedge trimmer by the guard.
3. Never operate the hedge trimmer with damaged guards or without guards in place.
4. Do not use stepladders whilst operating the hedge trimmer.
5. Remove the plug from the mains :-
 - before leaving the hedge trimmer unattended for any period;
 - before clearing a blockage;
 - before checking, cleaning or working on the appliance;
 - if you hit an object. Do not use your hedge trimmer until you are sure that the entire hedge trimmer is in a safe operating condition;
 - if the hedge trimmer starts to vibrate abnormally. Check immediately. Excessive vibration can cause injury.
 - before passing to another person.

Maintenance and storage

1. Keep all nuts, bolts and screws secure to be sure the hedge trimmer is in safe working condition.
2. Replace worn or damaged parts for safety.
3. Be careful during adjustment of the hedge trimmer to prevent entrapment of the fingers between moving blades and fixed parts of the machine.
4. Store in a cool dry place and out of reach of children. Do not store outdoors.
5. Allow the product to cool for at least 30 minutes before storing.

Cables

CABLES IMPORTANT

If you want to use an extension cable when operating your product, only the following cable dimensions should be used.

- 1.0 mm² : max length 40m
- 1.5 mm² : max length 60m
- 2.5 mm² : max length 100m

Minimum rating :

1.00mm² size cable, 10 amps 250 volts AC.

• YOUR HEDGE TRIMMER IS SUPPLIED WITH CABLE WIRED DIRECTLY INTO THE PRODUCT.

1. If the supply cord is damaged, it must be replaced by your local Husqvarna UK Ltd. Approved Service Centre or similarly qualified persons in order to avoid a hazard.
2. Flymo Extension Cables are available from your local Husqvarna UK Ltd. Approved Service Centre.
3. Do not wire an extension cable directly to your product yourself. Please contact your local Husqvarna UK Ltd. Approved Service Centre for further information on the connectors and kits available.
4. Only use extension cables specifically designed for outdoor use and which conform to one of the following specifications: Ordinary rubber (60245 IEC 53), Ordinary PVC (60227 IEC 53) or Ordinary PCP (60245 IEC 57)

CONNECTORS

IMPORTANT

- Connectors are suitable for use with 2 core cable only. Under no circumstances should these connectors be used for earthed products.
- All connectors and cables are of splashproof construction. They are not waterproof and must not be left outside permanently nor should they be submerged or immersed in water. Do not let cable lay or

trail through pools of water or splashed with water from hose pipes.

MAINS PLUG REPLACEMENT - IMPORTANT

- **If the plug supplied is cut off it should be destroyed. There is an electric shock hazard if a cut off plug is inserted into a 13 amp socket.**
1. **No earth required.** Our products are double insulated to EN60745 and under no circumstances should an earth be connected to any part of the product.
 2. **Ensure the mains voltage suits your product**
 3. **IMPORTANT!**
The wires in the mains lead are coloured in accordance with the following code:
BLUE - NEUTRAL
BROWN - LIVE
The wire which is coloured BLUE must be connected to the Terminal which is marked with the letter 'N' or coloured BLACK.
The wire which is coloured BROWN must be connected to the Terminal which is marked with the letter 'L' or coloured RED.
 4. It is important that the outer sheath is clamped correctly into the 3-pin plug.
 5. If in doubt consult your local Service Repairer or qualified electrician before the machine is used.
 6. **A 13 Amp fuse must be fitted to the Mains Plug.**
 7. The normal plug fuse and household fuse only protect the electrical equipment and are not a safeguard against electrocution.

If your product is hard wired i.e. non-detachable mains electric cable, a conversion kit and extension cable is available from all Approved Service Centres which can be found in your local Yellow Pages.

Assembly

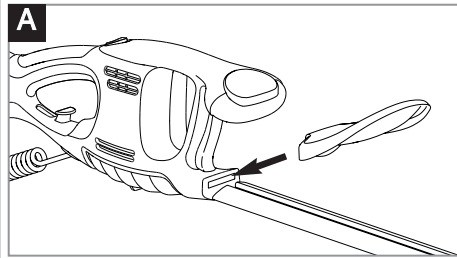

Assembly of Handguard.

1. Insert Handguard into slot as illustrated in **figure A**, ensuring that it is securely located.
DO NOT USE THE PRODUCT WITHOUT FITTING THE HANDGUARD

Before Use

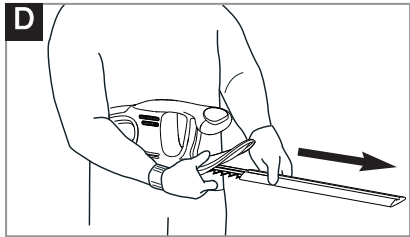
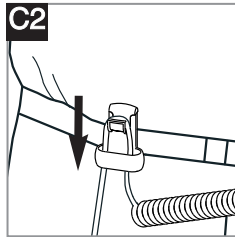
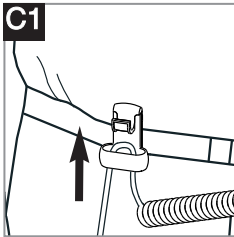
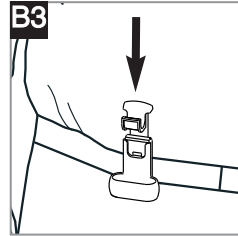
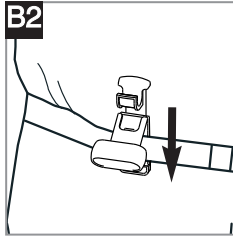
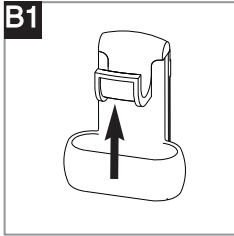

Before starting your hedge trimmer.

- **Securing the cable in the Belt Clip helps keep the cable away from blade.**

1. Push up the hook on the Belt Clip (**B1**)
2. Place the rear section of the Belt Clip behind your belt (**B2**)
3. Push down the hook on the Belt Clip to secure it onto your belt (**B3**)
4. Form a loop in the mains cable and push the loop through the hole in the Belt Clip (**C1**) ensuring the coil in the cable is close to the clip.
5. To secure, position the loop over the hook and pull back (**C2**).
6. Connect to mains and switch on
7. Remove blade cover (**D**).

Starting and Stopping

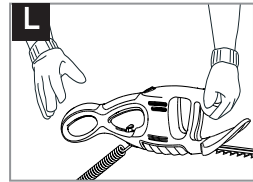
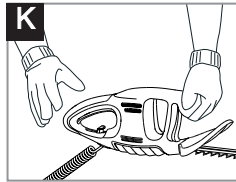
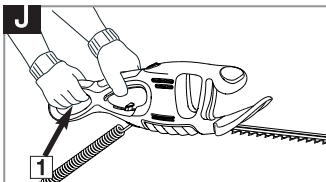
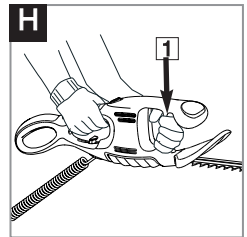
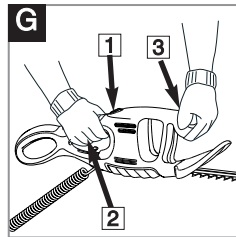
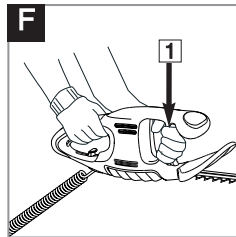
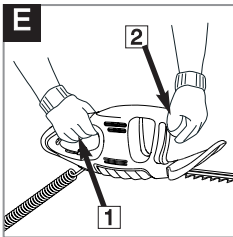

To start your hedge trimmer

EasiCut 420/450/510

1. There are three switch levers fitted to your Hedge trimmer.
2. Main switch lever (**E1**) and one other switch lever need to be held in the operating position (**E2** or **F1**) for the product to start.

2. To start, push forward the lock-off button (**G1**), squeeze the main switch lever (**G2**), release lock-off button.
3. Main switch lever (**G2**) and one other need to be held in the operating position (**G3**, **H1** or **J1**) for the product to start.

To start your hedge trimmer

EasiCut 600XT

1. There are four switch levers fitted to your hedge trimmer.

To stop your hedge trimmer

- Move hedge trimmer away from cutting area before stopping.

1. To stop, release any switch lever. (**K**, **L**)

How to Use

How to Use your hedge trimmer

1. Inspect area to be cut before each use - remove objects which can be thrown or become entangled in the cutting blades.
2. Always keep the hedge trimmer in front of your body. Hold handle firmly with both hands and stand in a secure and stable position.
3. Allow the cutting blades to reach full speed before entering the material to be cut.
4. Always work going away from people and solid objects such as walls, large stones, trees, vehicles etc.
5. If blade stalls, immediately stop the hedge trimmer. Disconnect the hedge trimmer from the power source and clear jammed debris from the cutting blades. Inspect blades and repair or replace as needed.

Top Cutting

Use a wide sweeping motion. **(M)** A slight downward tilt of the cutting blades in the direction of motion gives the best cutting results.

Side Cutting

When trimming the sides of the hedge, begin at the bottom and cut upwards **(N)**, tapering the hedge inward at the top. This shape will expose more of the hedge, resulting in more uniform growth.

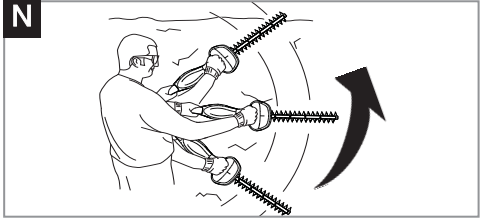
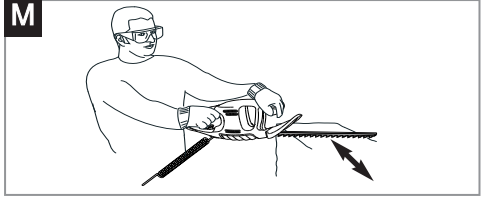

Caring for your Hedgetrimmer

- **WARNING**
Disconnect from the mains electricity supply, before attempting any maintenance or adjustment.

Cleaning (P)

1. Using a soft brush - remove debris from all air intakes and cutting blade.
2. Wipe over surface of your hedge trimmer with a dry cloth.

- **IMPORTANT**

Never use water for cleaning your hedge trimmer. Do not clean with chemicals, including petrol, or solvents - some can destroy critical plastic parts.

Lubricating the Cutting Blade

For easier operation and longer life, lubricate the cutter blades before and after use. Apply the oil so that it runs between the two blades. **(R)**.

At the end of the Cutting Season.

1. Clean your hedge trimmer thoroughly.
2. Check that all nuts and bolts are secure.
3. Visually inspect the hedge trimmer for any worn or damaged parts, contact your local Service Centre if any parts require replacement.

To store your hedge trimmer

- Ensure the blade cover is fitted before storage.
- Store in a dry place where your hedge trimmer is protected from damage.

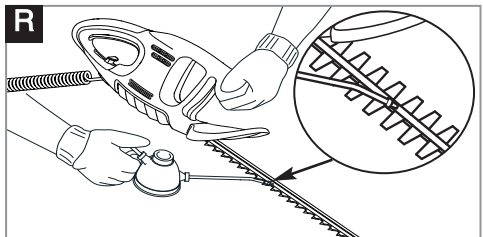
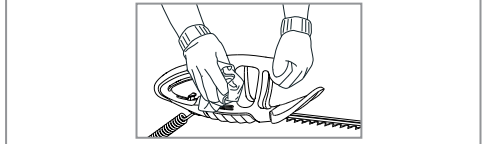
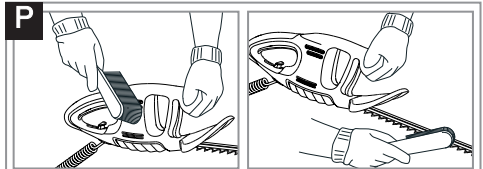

Fault Finding Hints

Fails to Operate

1. Is the Power Turned On?
2. Check the fuse in the plug, if blown replace.
3. Fuse continues to blow?

Immediately disconnect from the mains electricity supply and consult your local approved Service Centre.

Cutting blade stops under load

1. Cut at a slower pace.
2. If cutting blade still stops under load?

Disconnect from the mains electricity supply and consult your local approved Service Centre.

Fails to stop when one switch lever is released.

Immediately disconnect from the mains electricity supply and consult your local approved Service Centre.

Poor cut quality

1. Ensure the product is being used correctly (see How

to Use)

2. Ensure blades are free from trapped debris
3. Damaged Blades?

Immediately disconnect from the mains electricity supply and consult your local approved Service Centre.

Excessive Vibration

Immediately disconnect from the mains electricity supply and consult your local approved Service Centre.

Environmental Information

- Awareness of the environment must be considered when disposing of 'end-of-life' product.
- If necessary, contact your local authority for disposal information.



The symbol  on the product or on its packaging indicates that this product may not be treated as household waste. Instead it shall be handed over to the applicable collection point for the recycling of electrical and elec-

tronic equipment. By ensuring this product is disposed of correctly, you will help prevent potential negative consequences for the environment and human health, which could otherwise be caused by inappropriate waste handling of this product. For more detailed information about recycling of this product, please contact your local council office, your household waste disposal service or the shop where you purchased the product.

Guarantee & Guarantee Policy

If any part is found to be defective due to faulty manufacture within the guarantee period, Husqvarna UK Ltd., through its Authorised Service Repairers will effect the repair or replacement to the customer free of charge providing:

- (a) The fault is reported directly to the Authorised Repairer.
 - (b) Proof of purchase is provided.
 - (c) The fault is not caused by misuse, neglect or faulty adjustment by the user.
 - (d) The failure has not occurred through fair wear and tear.
 - (e) The machine has not been serviced or repaired, taken apart or tampered with by any person not authorised by Husqvarna UK Ltd.
 - (f) The machine has not been used for hire.
 - (g) The machine is owned by the original purchaser.
 - (h) The machine has not been used outside of the country for which it was specified.
 - (i) The machine has not been used commercially.
- * This guarantee is additional to, and in no way diminishes the customers statutory rights.

Failures due to the following are not covered, therefore it is important that you read the instructions contained in

this Operator's Manual and understand how to operate and maintain your machine:

Failures not covered by guarantee

- * Replacing worn or damaged blades
- * Failures as a result of not reporting an initial fault.
- * Failures as a result of sudden impact.
- * Failures as a result of not using the product in accordance with the instructions and recommendations contained in this Operator's Manual.
- * Machines used for hire are not covered by this guarantee.
- * The following items listed are considered as wearing parts and their life is dependent on regular maintenance and are, therefore not normally subject to a valid warranty claim: Blades, Electric Mains cable.
- * **Caution!** Husqvarna UK Ltd. does not accept liability under the warranty for defects caused in whole or part, directly or indirectly by the fitting of replacement parts or additional parts that are not either manufactured or approved by Husqvarna UK Ltd., or by the machine having been modified in any way

Service Recommendations

1. We strongly recommend that your product is serviced at least every twelve months, more often in a professional application.
2. Always use genuine Flymo Spare Parts.
3. Pre-packed spares are available from most Flymo Approved stockists.
4. Your product is uniquely identified by a silver and black product rating label
5. If you have a problem with your machine contact your local Approved Service Centre ensuring you have full details of your product as described on the product rating label.

6. **Should it be necessary for work to be carried out by your Service Centre, it is important to take your complete machine including cable and any extension cables used.**

A network of specialist dealers can be found in your local Yellow Pages. To obtain service on your product simply telephone or visit your local Service Centre. Should you require service under the terms of our guarantee the Service Centre will require proof of purchase.

All of the centres listed stock genuine Flymo Spare Parts.

NOTE: Our Service Repairers act on their own behalf and are not empowered to commit or legally bind Husqvarna UK Ltd. in any manner whatsoever.

EC Declaration of Conformity

Husqvarna AB, S-561 82 Huskvarna, Sweden

Declare under our sole responsibility that the product(s);

Designation.....**Hedge-trimmer**
 Designation of Type(s).....**EC420, EC450, EC500, EC510, EC600**
 Identification of Series.....**See Product Rating Label**
 Year of Construction.....**See Product Rating Label**

Conforms to the essential requirements & provisions of the following EC Directives:

2006/42/EC, 2004/108/EC, 2000/14/EC, 2011/65/EU

based on the following EU harmonized standards applied:

EN60745-1, EN60745-2-15, EN50366, EN55014-1, EN61000-3-2, EN61000-3-3

The maximum A weighted sound pressure level L_{pA} at the workstation, measured according to EN60745-2-15 is given in the table.

The maximum hand / arm vibration weighted value $a_{h,}$ measured according to EN60745-2-15, on a sample of the above product(s) is given in the table

The declared vibration tool value has been measured in accordance with a standard test method and may be used for comparing one tool with another.

The declared vibration total value may also be used in a preliminary assessment of exposure.

Warning:

The vibration emission during actual use of the power tool can differ from the declared total value depending on the ways in which the tool is used.

Operators should identify safety measures to protect themselves that are based on an estimation of exposure in the actual conditions of use (taking account of all parts of the operating cycle such as the times when the tool is switched off and when it is running idle in addition to the trigger time).

2000/14/EC: The Measured Sound Power L_{WA} & Guaranteed Sound Power L_{WA} values are according to the tabulated figures.

Conformity Assessment Procedure..... Annex V

Huskvarna 17/02/2012

A. Rangert
 Global R & D Director - Hand held
 Keeper of technical documentation



Type	EC420	EC450	EC500	EC510	EC600
Blade length (cm)	42	45	51	51	60
Power (kW)	0.42	0.45	0.45	0.50	0.50
Measured Sound Power L_{WA} (dB(A))	97	97	99	99	96
Guaranteed Sound Power L_{WA} (dB(A))	99	106	104	106	97
Sound Pressure L_{pA} (dB(A))	86	86	88	88	85
Uncertainty K_{pA} (dB(A))	2.5	2.5	2.5	2.5	2.5
Hand / arm vibration $a_{h,}$ (m/s ²)	5.56	5.53	5.22	2.23	3.30
Uncertainty $K_{a,}$ (m/s ²)	1.5	1.5	1.5	1.5	1.5
Weight (Kg)	2.8	2.8	2.8	2.9	3.0

Husqvarna AB
 S-561 82
 Huskvarna
 Sweden

Our policy of continuous improvement means that the specification of products may be altered from time to time without prior notice.
 Copyright © 2012 FLYMO S.A. All rights reserved. FLYMO® and other product and feature names are registered or unregistered trademarks of FLYMO S.A.

5054534-05

