**Art. 4273/4274**

D	Gebrauchsanweisung lightline Transformatoren ST 30/1 – ST 60/2 – ST 100/2 – Leuchten
GB	Operating Instructions lightline Transformers ST 30/1 – ST 60/2 – ST 100/2 – Lamps
F	Mode d'emploi Transformateurs lightline ST 30/1 – ST 60/2 – ST 100/2 – Luminaires
NL	Gebruiksaanwijzing lightline Transformatoren ST 30/1 – ST 60/2 – ST 100/2 – Lampen
S	Bruksanvisning lightline Transformatorer ST 30/1 – ST 60/2 – ST 100/2 – Lampor
FI	Käyttöohje lightline Muuntajat ST 30/1 – ST 60/2 – ST 100/2 – Valaisimet
I	Istruzioni per l'uso lightline Trasformatore ST 30/1 – ST 60/2 – ST 100/2 – Lampade
E	Manual de instrucciones lightline Transformadores ST 30/1 – ST 60/2 – ST 100/2 – Faroles
P	Instruções de manejo lightline Transformadores ST 30/1 – ST 60/2 – ST 100/2 – Lampiões
TR	Kullanma Talimatı lightline Transformatörler ST 30/1 – ST 60/2 – ST 100/2 – Lambalar
GR	Οδηγίες χρήσης lightline Μετασχηματιστές ST 30/1 – ST 60/2 – ST 100/2 – φωτιστικά
DK	Bruksanvisning lightline Transformere ST 30/1 – ST 60/2 – ST 100/2 – Lamper
N	Bruksanvisning lightline Transformatorer ST 30/1 – ST 60/2 – ST 100/2 – Lamper

Abb. A



Abb. A 1



Abb. A 2

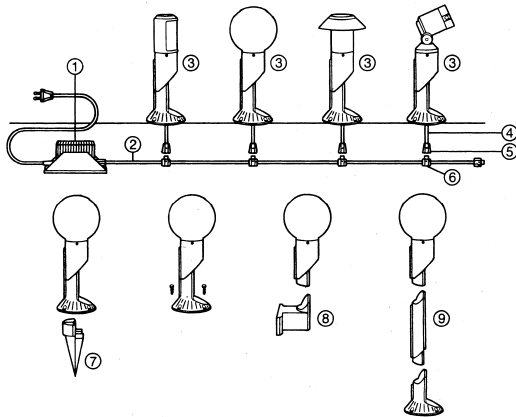

Abb. A 3

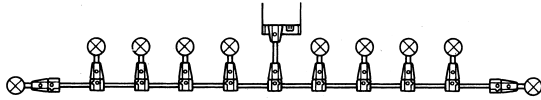

Abb. B

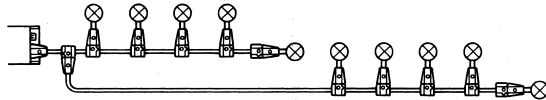

Abb. C

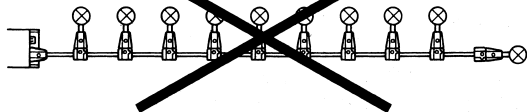

Abb. D



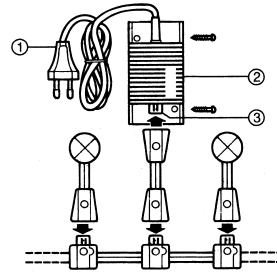

GARDENA® *lightline*

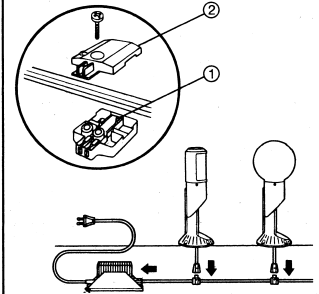
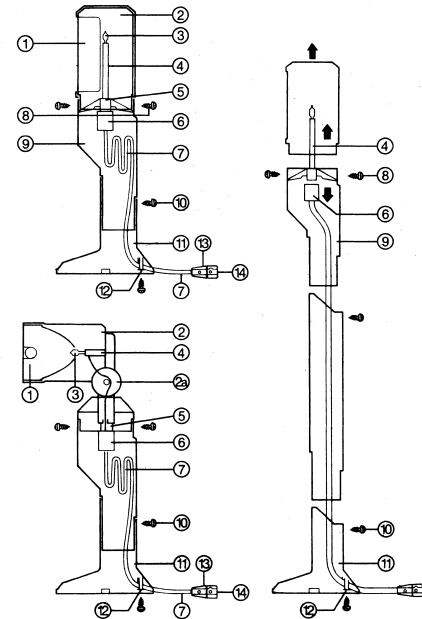
Transformers

ST 30/1 (Art. No. 4273)

ST 60/2 (Art. No. 4274)

ST 100/2 (Art. No. 4275)

Lamps

**(Art. No. 4200, 4202,
4204, 4206, 4208)**

Operating Instructions

Contents

1. General comments on the operating instructions
2. Proper use
3. System units
4. Installation and initial operation
5. Transformers
 - 5.1. Technical data
 - 5.2. Operating parts
 - 5.3. Connecting capacity
 - 5.4. Maintenance and care
6. *lightline* lamps
 - 6.1. Technical data
 - 6.2. Operating parts
 - 6.3. Extending the lamps
 - 6.4. Changing bulbs
 - 6.5. Maintenance and care
7. Troubleshooting
8. Safety and operating instructions
9. Guarantee

1. General comments on the operating instructions

These instructions will help you to put your system into operation easily, quickly and correctly.

Please read these instructions carefully to make yourself familiar with the products and the safety instructions.

2. Proper use

GARDENA *lightline* is a 12 V low-voltage system for illuminating your garden and terrace.

 **Attention! The GARDENA *lightline* lamps, cables, control units and connectors are only manufactured for use with 12 V low voltage. Connection to 240 V can cause fatal injuries.**

3. System units (Ill. A)

1. Transformers (ST 30/1, ST 60/2, ST 100/2)
2. Installation cable 15 m (49 ft.)/ 25 m (82 ft.), fitted with plug and socket
3. Lamps
4. Connection cable for lamps
5. Plug for connection cable
6. Socket
7. Spike
8. Lamp wall holder (accessories)
9. Extension (accessories)

4. Installation and initial operation

Before installing your GARDENA *lightline* system you should make a sketch in which you mark the area to be illuminated. For optimal installation please see examples (Ill. A 1, A 2).

- If possible, locate the transformer in the middle of the cable run (Ill. A 1).
- Avoid long cable runs (Ill. A 3); and branch off the installation cable, are preferable (Ill. A 2).
- Due to voltage drop it is not recommended that you group several lamps at the end of the cable.
- Whilst planning the different lamps to be used, take into account that using different types means achieving different light effects.
- When planning the installation, please consider the different lamp fixing options:
 - with screws on solid ground (wood, concrete, etc.)
 - with spike (Art. No. 4317) directly into the soil
 - on the wall with special Lamp Wall Holder (Art. No. 4313).
- To ensure adequate cable elasticity, we recommend to install the GARDENA *lightline* system only at temperatures above 0° C.

Transformer installation (Ill. B)
GARDENA *lightline* transformers are suitable for outdoor use.

- Transformers can be installed on the ground or on the wall.
- When mounting on the wall please make sure that connection socket (3) points downwards.
- When mounting on the ground please make sure that the transformer is not exposed to direct rain or mechanical dangers.

Do not expose transformers to direct sunlight.

When using Transformers ST 60/2 + ST 100/2 it is possible to connect 1 or 2 cable lines. If necessary, installation cable can be branched off, as shown in ill. B.

- Now, lay installation cable.
- Install the lamps so that the connection cable of the lamp reaches the installation cable.

Connection of lamps to the installation cable (Ill. C)

- Release coupling's connection socket from plug and unscrew socket.
- Locate and press down installation cable on both cutting contacts (1). As the GARDENA *lightline* system operates with alternating current the cable can be inserted in the socket on either side.
- Press firmly and screw socket cover back up.
- Now, connect the plug of the lamp cable to the socket of the installation cable.

Proceed the same way when installing the other lamps.

Cable can be installed above and below ground.

After finishing the installation insert the plug of the installation cable into the socket of the transformer. Then, connect power plug to the mains.

5. Transformers

5.1 Technical data

Transformers ST 30/1, ST 60/2 and ST 100/2 are sealed

low-voltage, safety transformers with integrad thermal relay for protection against damage caused by overloading or short circuit.

	ST 30/1	ST 60/2	ST 100/2
Voltage:	240 V/12 V, 50 Hz	240 V/12 V, 50 Hz	240 V/12 V, 50 Hz
Power:	30 W	60 W	100 W
No. of low-voltage outputs:	1	2	2
Max. Surrounding temperature:	+ 40° C	+ 40° C	+ 40° C
Safety class:	II	II	II
Mains calbe:	2 m H 05 RNF	2 m H 05 RNF	2 m H 05 RNF
Area of use:	for indoor and outdoor installation	for indoor and outdoor installation	for indoor and outdoor installation
Max. connectable cable length:	30 m	50 m	1 lane: max. 100 m 2 lanes: max. 100 m in total

5.2. Operating parts

1. 2 m mains cable
2. Sealed housing
3. Connection socket for installation cable

the transformer, the power demand of the lamps and the cable length.

GARDENA *lightline* lamps are fitted with a 10 W halogen bulb, Spotlight 50 W (Art. No. 4208) with a 50 W halogen bulb, GARDENA *lightline* Path Lights with a 3 W light bulb.

5.3. Connecting capacity

The connecting capacity depends on the performance of

Examples of calculation:

Transformer	ST 30/1	ST 60/2	ST 100/2
Power:	30 W	60 W	100 W
Max. no. of connectable			
50 W spotlights:	-	1	2

Examples of calculation:

Transformer	ST 30/1	ST 60/2	ST 100/2
10 W lamps:	3	6	10
3 W path lights:	10	20	33
Max. cable length:	30 m	50 m	100 m
Examples for combinations of GARDENA <i>lightline</i> -lamp types:	1 x 10 W 5 x 3 W total 25 W	3 x 10 W 10 x 3 W total 60 W or 3 x 10 W 5 x 3 W total 45 W	7 x 10 W 10 x 3 W total 100 W or 8 x 10 W 5 x 3 W total 95 W or 1 x 50 W 5 x 10 W total 100 W

Rate the number of max. connectable lamps by simply adding the Watt values.

⚠ Attention! The total Watt value of the lamps to be connected must not exceed the total Watt value of the transformer.

The lights are fully fitted with bulb, plug, socket and connection cable.

6.2. Operating parts (III. D)

- 1) Lampshade or reflector
- 2) Half shade or reflector head
- 2a) Pivot for adjustable reflector head
- 3) 10 W/50 W halogen bulb
- 4) Lamp holder
- 5) Plug
- 6) Connection socket
- 7) 90 cm connection cable
- 8) Screws for fixing lampshade
- 9) Shade receptacle
- 10) Screw for fixing shade receptacle
- 11) Lamp stand
- 12) Cable clamp
- 13) Plug
- 14) Socket for connection to GARDENA installation cable

5.4. Maintenance and care

Your GARDENA *lightline* transformer is maintenance-free.

Check the connection of the transformer output/installation cable regularly for dirt accumulations and clean, if necessary.

6. *lightline* Lamps

6.1. Technical data

Voltage: 12 V
Halogen bulbs:
10 W with G 4 base or
50 W with GY 6,35 base
(only Spotlight, Art. No. 4208)

6.3. Extending the lamps (III. D)

The lights can be extended by means of GARDENA Extension (Art. No. 4311).

Procedure holding:

- Release screws (8) the lampshade.
- Remove lampshade.
- Take off lamp holder (4) and disconnect connection socket (6).
- Release screw (10) from lamp stand (11).
- Pass cable through extension.
- Plug extension onto lamp stand (11).
- Screw extension on lamp stand.
- Pull cable through shade receptacle.
- Insert shade receptacle into extension and secure.
- If necessary release cable clamp (12) and tighten up cable as required.
- Fit connection socket (6) on lamp holder (4).
- Insert lamp holder into shade receptacle and screw up lampshade.

Mounting with spike

With the accessory 4317 you have the choice of fixing the lights directly into the ground.

Proceed as follows:

Stick the spike into the lamp stand and insert the connection cable into the cable run. Fasten spike on to the lamp stand with the screw supplied.

6.4. Changing bulbs (III. D)

The GARDENA *lightline* lamps are provided with common 10 W or 50 W halogen bulbs. See point 6.1.

Defective halogen bulbs are replaced by first releasing screws (8) and then removing lampshade (1). Now take the defective bulb off the lamp holder (4) and replace it with a new halogen bulb. Ask your dealer for GARDENA Replacement Bulbs.

⚠ Make sure that only bulbs with max. 12 Volt/10 W are used. (Except for Art. No. 4208 where a 12 Volt/50 W bulb is required).

⚠ Do not touch the halogen bulbs with your bare hands. Do not expose the halogen bulbs to dirt or moisture before installation.

⚠ Make sure that the bulb socket is located correctly in the lamp holder.

⚠ Do not touch lighted halogen bulbs as they can inflict serious burns.

6.5 Maintenance and care

The GARDENA *lightline* lamps are maintenance-free.

In summer insects may gather on the lamp shades and produce dirt. If so, please clean your lamps regularly with a damp cloth. Do not use corrosive or scouring cleansing agents.

7. Troubleshooting

Problem	Possible Cause	Remedy
Complete lighting system fails, that means that the thermal relay of the transformer has been activated due to overload.	Too many lamps are connected	Disconnect power plug from the mains and reduce number of lamps. The total Watt value of connected lights must not exceed the total Watt value of the transformer.
	Transformer has been exposed to intense sunlight.	Disconnect power plug from the mains and let transformer cool down before new operation.
	Short circuit, caused by defective cable, defective halogen bulb or improperly installed connections.	Disconnect power plug from the mains and, starting with the transformer, check all couplings, connections and halogen bulbs to locate the source of the short circuit.

After rectification connect power plug again to the mains.

With all other malfunctions, please contact a GARDENA service centre or a dealer authorized by GARDENA.

8. Safety and operating instructions

⚠ The GARDENA *lightline* system is proof against water jets and frost-resistant. It can be installed outside the whole year round.

⚠ Only use Original GARDENA *lightline* parts, otherwise we cannot guarantee sound operation.

⚠ Check mains cable and power plug regularly for defects. Plug and cable may only be used if they are in perfect condition. If the power cable is faulty, disconnect it immediately from the mains.

⚠ In sealed transformers it is not possible to replace defective mains cables.

⚠ Use all GARDENA *lightline* products exclusively for 12 volt low voltage. Connection to 240 V would be very dangerous and may cause fatal injuries.

⚠ For safety reasons supply each *lightline* system with one transformer only. A parallel connection of two transformers is inadmissible!

⚠ Damaged power cables cannot be exchanged.

We expressly point out that, in accordance with the product liability law, we are not liable for any damage caused by our units if it is due to improper repair or if parts exchanged are not original GARDENA parts or parts approved by us, and, if the repairs were not carried out by a GARDENA Service Centre or an authorised specialist. The same applies to spare parts and accessories.

EU Certificate of Conformity

The undersigned

GARDENA Manufacturing GmbH · Hans-Lorenser-Str. 40 · 89079 Ulm

hereby certifies that, when leaving our factory, the units indicated below are in accordance with the harmonised EU guidelines, EU standards of safety and product specific standards.

This certificate becomes void if the units are modified without our approval.

Description of the units: Transformers
Types: ST 60/2 ; ST 30/1; ST 100/2
Art. No.: 4274; 4273; 4275
EU directives: Electromagnetic Compatibility
2004/108/EC
Low Voltage Directive 2006/95/EC
Directive 93/68/EC

Year of CE marking: 1994

Ulm, 1. 7. 1999



Thomas Heini
Technical Dept. Manager

Disposal:
(in accordance with
directive 2002/96/EC)



Unit may not be disposed of with normal household waste but must be disposed of in accordance with environmental regulations.

9. Guarantee

GARDENA grants a 10 year guarantee for these products (from the date of purchase). This guarantee refers to all significant defects of the unit which can be proven to be caused by material or manufacturing flaws. Illuminants (bulbs) are excluded from this regulation. We would like to point out that the GARDENA *lightline* products may fade if exposed to intense sunlight. This also applies to the lampshade or reflector. But this in no way affects the function of the products and is, therefore, not part of the standard warranty.

This guarantee covers, within our discretion, either replacement delivery of a unit in perfect working order or repair of the unit sent in, if the following prerequisites have been fulfilled:

- The unit has been operated properly and according to the recommendations in the instructions. Neither the buyer nor a third party has tried to repair the unit.
- The guarantee becomes void unless – in case of exchange or in need of supplementary parts and accessories – Original GARDENA units were used.
- The unit is sent directly to one of the GARDENA service centres with paid postage along with the attached, completely filled out guarantee card or invoice.

This manufacturer's guarantee does not affect the existing claim to guarantee against the dealer/seller and does not affect in any way the buyer's statutory rights.

D

Im Reklamationsfall die Garantiekarte ausschneiden und mit dem Gerät einsenden.

GB

In case of claim cut out the warranty card and send it together with the unit to the GARDENA Service Centre.

F

En cas de réclamation, découpez la carte de garantie et retournez-la avec l'appareil au Service Après-Vente de GARDENA France.

NL

In geval van reclamatie de garantie-kaart uitknippen en tezamen met het apparaat opsturen.

S

Klipp ut garantikort et och sänd det tillsammans med produkten till GARDENA Service.

FIN

Mikäli kyseessä on takuutoimenpide, täytä takuukortti ja lähetä se laitteen kanssa maahantuojalle.

I

In caso di reclamo ritagliare il certificato di garanzia e spedirlo insieme al prodotto.

E

En el caso de reclamación, rogamos enviar la presente Tarjeta de Garantía con el aparato.

P

Em caso de reclamação destaque a carta de garantia e envie-a junto com o aparelho.

TR

Bir şikayetiniz olduđu takdirde aleti garanti kartı ile birlikte yetkili GARDENA servisine gönderiniz.

GR

Σε περίπτωση βλάβης εντός του χρόνου της εγγύησης, κόψτε την κάρτα εγγύησης και φέρτε τη πλήρως συμπληρωμένη μαζί με το είδος στο σέρβις της GARDENA.

DK

Vær venlig i tilfælde af reklamation at klippe garantikortet ud og sende den ind sammen med produktet.

N

I tilfelle reklamasjon, vær vennlig og klipp ut garantikortet, og send det sammen med produktet til GARDENA Norge A/S.

Beanstandung:
Reasons for complaint:
Défaut constaté :
Klacht:
Reklamation:
Vaatimus:
Reclamo:
Reclamación:
Motivo de reclamação:
Sikayet Sebebi:
Vian selvitys:
Πρόβλημα:
Reklamation:
Reklamasjon:



Garantiekarte
Warranty Card
Carte de garantie
Garantiekaart
Garantikort

Takuukortti
Certificato di garanzia
Tarjeta de garantía
Carta de garantía
Garanti korti

Κάρτα Εγγύησης
Garantibevis
Garantibevis

<i>lightline</i> Transformatoren	ST 30/1 – ST 60/2 – ST 100/2 – Leuchten
<i>lightline</i> Transformers	ST 30/1 – ST 60/2 – ST 100/2 – Lamps
<i>lightline</i> Transformateurs	ST 30/1 – ST 60/2 – ST 100/2 – Luminaires
<i>lightline</i> Transformators	ST 30/1 – ST 60/2 – ST 100/2 – Lampen
<i>lightline</i> Transformatorer	ST 30/1 – ST 60/2 – ST 100/2 – Lamper
<i>lightline</i> Muuntajat	ST 30/1 – ST 60/2 – ST 100/2 – Valaisimet
<i>lightline</i> Trasformatori	ST 30/1 – ST 60/2 – ST 100/2 – Lampade
<i>lightline</i> Transformadores	ST 30/1 – ST 60/2 – ST 100/2 – Faroles
<i>lightline</i> Transformadores	ST 30/1 – ST 60/2 – ST 100/2 – Lampiões
<i>lightline</i> Transformatörer	ST 30/1 – ST 60/2 – ST 100/2 – Lambalar
<i>lightline</i> Μετασχηματιστές	ST 30/1 – ST 60/2 – ST 100/2 – Φωτιστικά
<i>lightline</i> Transformere	ST 30/1 – ST 60/2 – ST 100/2 – Lamper
<i>lightline</i> Transformatorer	ST 30/1 – ST 60/2 – ST 100/2 – Lamper

Wurde gekauft am:

Was purchased on:

Acheté le (date et lieu d'achat) :

Werd gekocht op:

Försäljningsdatum:

Ostopäivämäärä:

Data di acquisto:

Se vendió el:

Comprado em:

Satin Alma Tarihi:

Αγοράστηκε την:

Blev købt den:

Ble kjøpt hos:

Händlerstempel:

Dealer's stamp / Receipt:

Cachet du revendeur :

Stempel van de handelaar:

Återförsäljarens stämpel:

Jälleenmyyjän leima:

Timbro del rivenditore:

Sello del comerciante:

Carimbo do vendedor:

Alicinin imzası:

Σφραγίδα καταστήματος:

Forhandlers stempel:

Forhandlerstempel:



Service

Deutschland / Germany

GARDENA GmbH
Central Service
Hans-Lorenser-Straße 40
D-89079 Ulm
Produktfragen:
(+49) 731 490-123
Reparaturen:
(+49) 731 490-290
service@gardena.com

Albania

COBALT Sh.p.k.
Rr. Siri Kodra
1000 Tirana

Argentina

Husqvarna Argentina S.A.
Av.dei Libertador 5954 -
Piso 11 - Torre B
(C1428ARP) Buenos Aires
Phone: (+54) 11 5194 5000
info.gardena@
achusqvarna.com

Armenia

Garden Land Ltd.
61 Tigran Mets
0005 Yerevan

Australia

Husqvarna Australia Pty. Ltd.
Locked Bag 5
Central Coast BC
NSW 2252
Phone: (+61) (0) 2 4352 7400
customer.service@
husqvarna.com.au

Austria / Österreich

Husqvarna Austria GmbH
Consumer Products
Industriezeile 36
4010 Linz
Tel.: (+43) 732 77 01 01 - 90
consumerservice@husqvarna.at

Azerbaijan

Firm Progress
a. Aliyev Str. 26A
1052 Baku

Belgium

GARDENA Belgium NV/SA
Sterrebeekstraat 163
1930 Zaventem
Phone: (+32) 2 7 20 92 12
Mail: info@gardena.be

Bosnia / Herzegovina

SILK TRADE d.o.o.
Industrijska zona Bukva bb
74260 Tešanj

Brazil

Husqvarna do Brasil Ltda
Av. Francisco Matarazzo,
1400 - 19º andar
São Paulo - SP
CEP: 05001-903
Tel: 0800-112252
marketing.br.husqvarna@
husqvarna.com.br

Bulgaria

Хускварна България ЕООД
Бул. „Андрей Ляпчев“ № 72
1799 София
Tel.: (+359) 02/9753076
www.husqvarna.bg

Canada / USA

GARDENA Canada Ltd.
100 Summerlea Road
Brampton, Ontario L6T 4X3
Phone: (+1) 905 792 93 30
info@gardenacanada.com

Chile

Maquinarias Agroforestales
Ltda. (Maga Ltda.)
Santiago, Chile
Avda. Chesterton
8355 comuna Las Condes
Phone: (+56) 2 202 4417
Dalton@maga.cl
Zipcode: 7560330

Temuco, Chile

Avda. Valparaíso # 01466
Phone: (+56) 45 222 126
Zipcode: 4780441

China

Husqvarna (China) Machinery
Manufacturing Co., Ltd.
No. 1355, Jia Xin Rd.,
Ma Lu Zhen, Jia Ding Dist.,
Shanghai
201801
Phone: (+86) 21 59159629
Domestic Sales
www.gardena.com.cn

Colombia

Husqvarna Colombia S.A.
Calle 18 No. 68 D-31, zona
Industrial de Montevideo
Bogotá, Cundinamarca
Tel. 571 2922700 ext. 105
jairo.salazar@
husqvarna.com.co

Costa Rica

Compania Exim
Euroberoamericana S.A.
Los Colegios, Moravia,
200 metros al Sur del Colegio
Saint Francis - San José
Phone: (+506) 297 68 83
exim_euro@racsa.co.cr

Croatia

SILK ADRIA d.o.o.
Josipa Lončara 3
10090 Zagreb
Phone: (+385) 1 3794 580
silk.adria@zg.t-com.hr

Cyprus

Med Marketing
17 Digeni Akritia Ave
P.O. Box 27017
1641 Nicosia

Czech Republic

Husqvarna Česko s.r.o.
Türkova 2319/5b
149 00 Praha 4 – Chodov
Bezplatná infolinka :
800 100 425
servis@cz.husqvarna.com

Denmark

GARDENA / Husqvarna
Consumer Outdoor Products
Salgsafdelning Danmark
Box 9003
S-200 39 Malmö
info@gardena.dk

Dominican Republic

BOSQUESA, S.R.L
Carretera Santiago Licey
Km. 5 ½
Esquina Copal II.
Santiago, Dominican Republic
Phone: (+809) 736-0333
joserbosquesa@claro.net.do

Ecuador

Husqvarna Ecuador S.A.
Arupos E1-181 y 10 de Agosto
Quito, Pichincha
Tel. (+593) 22800739
francisco.jacome@
husqvarna.com.ec

Estonia

Husqvarna Eesti OÜ
Consumer Outdoor Products
Keskk tee 10, Aaviku küla
Rae vald
Harju maakond
75305 Estonia
kontakt.etj@husqvarna.ee

Finland

Oy Husqvarna Ab
Consumer Outdoor Products
Lautatarhankatu 8 B / PL 3
00581 HELSINKI
info@gardena.fi

France

GARDENA France
Immeuble Exposital
9-11 allée des Pierres Mayettes
ZAC des Barbanniers, B.P.99
-F- 92232 GENNEVILLIERS cedex
Tel. (+33) 01 40 85 30 40
service.consommateurs@
gardena.fr

Georgia

ALD Group
Beliashvili 8
1159 Tbilisi

Great Britain

Husqvarna UK Ltd
Preston Road
Aycliffe Industrial Park
Newton Aycliffe
County Durham
DL5 6UP
info.gardena@
husqvarna.co.uk

Greece

HUSQVARNA ΕΛΛΑΣ Α.Ε.Β.Ε.
Υπ. για Ηρώστου 33Α
Β. Π.ε. Κρωπίου
194 00 Κρωπί Αττικής
V.A.T. EL094094640
Phone: (+30) 210 66 20 225
info@husqvarna-consumer.gr

Hungary

Husqvarna Magyarorszag Kft.
Ezred u. 1- 3
1044 Budapest
Telefon: (+36) 1 251-4161
vevooszogalat.husqvarna@
husqvarna.hu

Iceland

Ó. Johnson & Kaaber
Tunguhalsi 1
110 Reykjavik
ooj@ojk.is

Ireland

Husqvarna UK Ltd
Preston Road
Aycliffe Industrial Park
Newton Aycliffe
County Durham
DL5 6UP
info.gardena@
husqvarna.co.uk

Service

Italy

Husqvarna Italia S.p.A.
Via Como 72
23868 VALMADRERA (LC)
Phone: (+39) 0341.203.111
info@gardenaitalia.it

Japan

KAKUICHI Co. Ltd.
Sumitomo Realty &
Development Kojimachi
BLDG., 8F
5 - 1 Nibanncyo
Chiyoda-ku
Tokyo 102-0084
Phone: (+81) 33 264 4721
m_ishihara@kaku-ichi.co.jp

Kazakhstan

LAMED Ltd.
155/1, Tazhibayevoi Str.
050060 Almaty
IP Schmidt
Abayavenue 3B
110 005 Kostanay

Kyrgyzstan

Alye Maki
av. Moladaya Guardir J 3
720014 Bishkek

Latvia

Husqvarna Latvija
Consumer Outdoor Products
Bakužu iela 6
LV-1024 Riga
info@husqvarna.lv

Lithuania

UAB Husqvarna Lietuva
Consumer Outdoor Products
Ateities pl. 77C
LT-52104 Kaunas
centras@husqvarna.lt

Luxembourg

Magasins Jules Neuberg
39, rue Jacques Stas
Luxembourg-Gasperich 2549
Case Postale No. 12
Luxembourg 2010
Phone: (+352) 40 14 01
api@neuberg.lu

Mexico

AFOSA
Av. Lopez Mateos Sur # 5019
Col. La Calma 45070
Zapopan, Jalisco
Mexico
Phone: (+52) 33 3818-3434
icornejo@afosa.com.mx
Moldova
Convel S.R.L.
290A Muncestri Str.
2002 Chisinau

Netherlands

GARDENA Nederland B.V.
Postbus 50176
1305 AD ALMERE
Phone: (+31) 36 521 00 00
info@gardena.nl

Neth. Antilles

Jonka Enterprises N.V.
Sta. Rosa Weg 196
PO. Box 8200

Curaçao

Phone: (+599) 9 767 66 55
pgm@jonka.com

New Zealand

Husqvarna New Zealand Ltd.
PO Box 76-437
Manukau City 2241
Phone: (+64) (0) 9 9202410
support.nz@husqvarna.co.nz

Norway

GARDENA
Husqvarna Consumer
Outdoor Products
Salgskontor Norge
Klevertveien 6
1540 Vestby
info@gardena.no

Peru

Husqvarna Perú S.A.
Jr. Ramón Cárcamo 710
Lima 1
Tel: (+51) 1 3320400 ext. 416
juan.remuzgo@
husqvarna.com

Poland

Husqvarna Poland Spółka z o.o.
ul. Wysockiego 15 b
03-371 Warszawa
Phone: (+48) 22 330 96 00
gardena@gardena.pl

Portugal

Husqvarna Portugal, SA
Lagoa - Albarraque
2635 - 595 Rio de Mouro
Tel.: (+351) 21 922 85 30
Fax : (+351) 21 922 85 36
info@gardena.pt

Romania

Madex International Srl
Soseava Odaii 117- 123,
RO 013603
București, S1
Phone: (+40) 21 352.76.03
madex@ines.ro

Russia

ООО „Хускварна“
141400, Московская обл.,
г. Химки,
улица Ленинградская,
владение 39, стр.6
Бизнес Центр
„Химки Бизнес Парк“,
помещение ОВ02_04

Serbia

Domel d.o.o.
Autoput za Novi Sad bb
11273 Belgrade
Phone: (+381) 118488812
miroslav.jejina@domel.rs

Singapore

Hy-Ray PRIVATE LIMITED
40 Jalan Pemimpin
#02-08 Tat Ann Building
Singapore 577185
Phone: (+65) 6253 2277
shiyng@hyray.com.sg

Slovak Republic

Husqvarna Česko s.r.o.
Türkova 2319/5b
149 00 Praha 4 – Chodov
Bezplatná infolinka:
800 154 044
servis@sk.husqvarna.com

Slovenia

Husqvarna Austria GmbH
Consumer Products
Industriezeile 36
4010 Linz
Tel. : (+43) 732 77 01 01- 90
consumer.service@
husqvarna.at

South Africa

Husqvarna
South Africa (Pty) Ltd
Postnet Suite 250
Private Bag X6,
Cascades, 3202
South Africa
Phone: (+27) 33 846 9700
info@gardena.co.za

Spain

Husqvarna España S.A.
C/ Basauri, nº 6
La Florida
28023 Madrid
Phone: (+34) 91 708 05 00
atencioncliente@gardena.es

Suriname

Agrofix n.v.
Verlengde Hogestraat #22
Phone: (+597) 472426
agrofix@sr.net
Pobox : 2006
Paramaribo
Suriname-South America

Sweden

Husqvarna AB
S-561 82 Huskvarna
info@gardena.se

Switzerland / Schweiz

Husqvarna Schweiz AG
Consumer Products
Industriestrasse 10
5506 Mägenwil
Phone: (+ 41) (0) 848 800 464
info@gardena.ch

Turkey

GARDENA Dost Dış Ticaret
Müessesilik A.Ş.
Sanayi Çad. Adil Sokak
No: 1/B Kartal
34873 Istanbul
Phone: (+90) 216 38 93 939
info@gardena-dost.com.tr

Ukraine / Україна

ТОВ «Хусварна Україна»
вул. Васильківська, 34,
офіс 204-г
03022, Київ
Тел. (+38) 044 498 39 02
info@gardena.ua

Uruguay

FELI SA
Entre Rios 1083 CP 11800
Montevideo - Uruguay
Tel : (+598) 22 03 18 44
info@felisa.com.uy

Venezuela

Corporación Casa y Jardín C.A.
Av. Caroní, Edif. Trezmen, PB.
Colinas de Bello Monte.
1050 Caracas.
Tif: (+58) 212 992 33 22
info@casayjardin.net.ve

4273-20.960.08/1211
© GARDENA Manufacturing GmbH
D-89070 Ulm
http://www.gardena.com