

# **Operator's manual Rider Battery**



Please read the operator's manual carefully and make sure you understand the instructions before using the machine.

**English**

---

# CONTENTS

---

## Contents

<b>CONTENTS</b>	
Contents .....	2
<b>INTRODUCTION</b>	
Dear Customer, .....	3
Driving and transport on public roads .....	3
Use .....	3
Good service .....	3
<b>Service journal</b>	
Pre-delivery service .....	4
<b>KEY TO SYMBOLS</b>	
Symbols .....	5
<b>SAFETY INSTRUCTIONS</b>	
Safety instructions .....	6
Driving on slopes .....	7
Children .....	7
Maintenance .....	8
Transport .....	8
Battery .....	8
<b>WHAT IS WHAT?</b>	
Location of the controls .....	9
<b>PRESENTATION</b>	
Presentation .....	10
Cutting unit .....	10
Seat .....	11
Battery .....	11
Warning light .....	12
<b>Driving</b>	
Before starting .....	13
Turn on the machine. ....	13
Driving the Rider .....	13
Cutting tips .....	14
Stopping .....	14
<b>Maintenance</b>	
Maintenance schedule .....	15
Cleaning .....	16
Removing of the machine hoods .....	16
Checking and adjusting the steering wires .....	17
Checking the brake .....	17
Check the level of the battery acid .....	17
Charging the batteries .....	17
Checking the tyre pressure .....	18
Fuses .....	18
Check the safety system .....	19
Removing the cutting unit .....	19
Checking the cutting unit's parallelism .....	20
Checking the blades .....	20
Removing the BioClip plug .....	21
Lubrication of drive chain .....	21
General lubrication .....	21
<b>Troubleshooting schedule</b>	
<b>Storage</b>	
Winter storage .....	23
Guard .....	23
Service .....	23
<b>TECHNICAL DATA</b>	

EC-declaration of conformity .....	26
------------------------------------	----

---

# INTRODUCTION

---

## Dear Customer,

Thank you for choosing a Husqvarna Rider. Husqvarna Riders are built to a unique design with a front-mounted cutting unit and a patented articulated steering. Riders are designed for maximum efficiency even in small or confined areas. Collected controls and a transmission controlled by pedals also contribute to the machine's performance.

This operator's manual is a valuable document. By following its instructions (on operation, service, maintenance, etc.) you will significantly extend the life of the machine and even its second-hand value.

When you sell your Rider, make sure you pass on the operator's manual to the new owner. Make sure that all service work and repairs are recorded. A well-documented service history reduces the costs of seasonal maintenance and influences the second-hand value of the machine. Bring the operator's manual with the Rider when bringing it to a workshop for service procedures.

## Driving and transport on public roads

Check the relevant road traffic regulations before driving the machine on a public road. If transporting the machine on another vehicle always use approved securing devices and make sure that the machine is securely held.

## Use

This ride-on mower is designed to mow grass on open and level ground surfaces. In addition, there is a number of accessories recommended by the manufacturer that broadens the application area. Please contact your dealer for more information about which accessories are available. The machine may only be used with the equipment recommended by the manufacturer. All other types of use are incorrect. Compliance with and strict adherence to the conditions of operation, service and repair as specified by the manufacturer also constitute essential elements of the intended use.

This machine should be operated, serviced and repaired only by persons who are familiar with its particular characteristics and who are acquainted with the relevant safety procedures.

Accident prevention regulations, all other generally recognised regulations on safety and occupational medicine, and all road traffic regulations must be observed at all times.

Any arbitrary modifications carried out to this machine may relieve the manufacturer of liability for any resulting damage or injury.

## Good service

Husqvarna products are sold all over the world and ensures that you, the customer, get the best support and service. For example, before this machine was delivered it was inspected and adjusted by your dealer. See the certificate in the Service Journal in this manual.

When you need spare parts or advice on service issues, warranty terms, etc., contact:

This Operator's Manual belongs to machine with serial number:	Engine	Transmission

On the machine's rating plate you will find the following information:

- The machine's type designation.
- The manufacturer's type number.
- The machine's serial number.

State the type designation and serial number when ordering spare parts.

---

# Service journal

---

## Pre-delivery service

- 1 Fit steering wheel, seat and any optional equipment.
- 2 Check and adjust tyre pressure. (60 kPa, 0.6 bar, 9 psi).
- 3 Attach the cutting unit to the machine, see Attaching the cutting unit.
- 4 Adjust cutting unit:  
Adjust cutting unit so that rear edge is about 5-7 mm / (1/5-1/4") higher than front edge.
- 5 Check the acid level in the batteries and top up with distilled water if necessary.
- 6 Connect battery.
- 7 Charge the battery using the battery charger supplied. See the "Charging the batteries" section.
- 8 Start the machine and check that it does not move in neutral.
- 9 Check:  
Forward drive.   
Reverse drive.   
Operation of blades.   
Seat safety switch.   
Lif lever safety switch.   
Safety switch for parking brake.   
The safety switch for the cutting deck
- 10 Tell customer about:  
Needs and benefits of following the service schedule.   
Servicing and the influence of this journal on the second-hand value of the machine.   
Range of applications for BioClip.   
Complete proof of sale etc.

Pre-delivery service carried out. No outstanding problems. Certified:

---

Date, mileage, stamp, signature

# KEY TO SYMBOLS

## Symbols

These symbols are on the machine and in the instructions.

**WARNING!** Careless or incorrect use can result in serious or fatal injury to the operator or others.



Please read the operator's manual carefully and make sure you understand the instructions before using the machine.



Use hearing protection



This product is in accordance with applicable EC directives.



Reverse



Neutral



Fast



Slow



Indicates battery status



Cutting height



Backwards



Forwards



**Warning:** rotating parts. Keep hands and feet clear.



Clutch in



Clutch out



Parking brake



Noise emission to the environment according to the European Community's Directive. The machine's emission is specified in the Technical data chapter and on the label.



Rotary blades Keep hands and feet away from under the hood when the engine is running



Never drive across a slope



Never use the machine if persons, especially children, or animals, are in the vicinity



Never carry passengers on the machine or equipment



Drive very slowly if no cutting unit is fitted



The cutting deck must be fitted at full speed.



Remove the ignition key before carrying out repair work or maintenance.

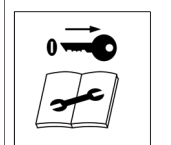

Battery-saving function



# SAFETY INSTRUCTIONS

## Safety instructions

These instructions are for your safety. Read them carefully.

### Insure your Rider

- Check the insurance coverage for your new Rider.
- Contact your insurance company.
- You should have fully comprehensive insurance including: third party, fire, damage, theft and liability

### General use

- Read all the instructions in this operator's manual and on the machine before you start it. Ensure you understand them and then observe them.



**WARNING! Always turn off the machine and remove the ignition key when:**

**the mowing area is cleared of foreign objects.**

**inspection, service, maintenance or repair work is carried out on the machine.**

**the machine begins to vibrate strongly.  
you are driving over foreign objects.**



**WARNING! This machine produces an electromagnetic field during operation. This field may under some circumstances interfere with active or passive medical implants. To reduce the risk of serious or fatal injury, we recommend persons with medical implants to consult their physician and the medical implant manufacturer before operating this machine.**

- Learn how to use the machine and its controls safely and learn to how to stop quickly. Also learn to recognize the safety decals.
- Only allow the machine to be used by adults who are familiar with its use.
- Make sure nobody else is in the vicinity of the machine when you start the engine, engage the drive or drive off.
- Clear the area of objects such as stones, toys, wires, etc. that may become caught in the blades and be thrown out.



- Turn off the machine before cleaning the cutting deck.
- Remember that the driver is responsible for dangers or accidents.

- Never carry passengers. The machine is only intended to be used by one person.



- Always look downwards and backwards before and while reversing. Keep watch for both large and small obstacles.
- Slow before cornering.
- Switch off the blades when you are not mowing.
- Take care when rounding a fixed object, so that the blades do not hit it. Never run the machine over foreign objects.



**WARNING! This machine can sever hands and feet as well as throw objects. Failure to observe the safety instructions can result in serious injuries.**

- Only use the machine in daylight or in other well-lit conditions. Keep the machine at a safe distance from holes or other irregularities in the ground. Pay attention to other possible risks.
- Never use the machine if you are tired, if you have consumed alcohol, or if you are taking other drugs or medication that can affect your vision, judgement or coordination.
- Keep an eye on the traffic when working close to a road or when crossing it.
- Never leave the machine unattended when it is running. Always disengage the blades, engage the parking brake and remove the ignition key before leaving the machine.
- Never allow children or other persons not trained in the use of the machine to use or service it. Local laws may regulate the age of the user.



**WARNING! You must use approved personal protective equipment whenever you use the machine. Personal protective equipment cannot eliminate the risk of injury but it will reduce the degree of injury if an accident does happen. Ask your dealer for help in choosing the right equipment. Never wear loose clothing or jewellery.**

# SAFETY INSTRUCTIONS

- Use hearing protection to minimise the risk of hearing impairment.



- Never wear loose-fitting clothing, jewellery or similar that can get caught in moving parts.
- Never use the machine when barefoot. Always wear protective shoes or protective boots, preferably with steel toes.



- Make sure that you have first aid equipment close at hand when using the machine.

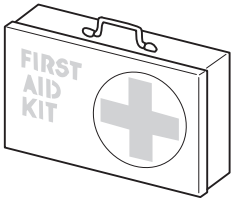

## Driving on slopes

Driving on slopes is one of the operations where the risk of the driver losing control of the machine or of it overturning is the greatest; this can result in serious injury or death. All slopes demand extra care. If you cannot reverse up a slope or if you feel unsure, do not mow it.

### IMPORTANT INFORMATION

Do not drive down slopes with the unit raised.

### This is what you do

- Remove obstacles such as stones, branches, etc.
- Mow upwards and downwards, not sideways.

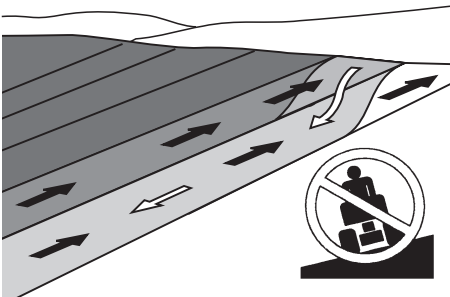

- Do not use the machine on ground that slopes more than 10°.
- Take extra care if any attachments are fitted that can change the stability of the machine.
- Avoid starting or stopping on a slope. If the tyres start to slip, stop the blades and drive slowly down the slope.

- Always drive smoothly and slowly on slopes.
- Do not make any sudden changes in speed or direction.
- Avoid unnecessary turns on slopes, if necessary, turn slowly and gradually downwards if possible. Drive slowly. Do not turn the wheel sharply.
- Watch out for and avoid driving over furrows, holes and bumps. It is easier for the machine to overturn on uneven ground. Tall grass can hide obstacles.

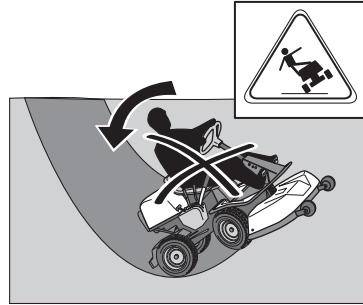

- Do not mow too close to edges, ditches or banks. The machine can suddenly overturn if one wheel comes over the edge of a steep slope or a ditch, or if an edge gives way.
- Do not mow wet grass. It is slippery, and tyres can lose their grip so that the machine skids.
- Do not try to stabilize the machine by putting your foot on the ground.
- When cleaning the chassis, the machine may never be driven near verges or ditches.
- When mowing, keep away from bushes and other materials in order to avoid a heating effect.

## Children

- Serious accidents may occur if you fail to be on your guard for children in the vicinity of the machine. Children are often attracted to the machine and mowing. Never assume that children will remain where you last saw them.
- Keep children away from the area to be mowed and under close supervision by another adult.
- Keep an eye out and shut off the machine if children enter the work area.
- Before and during reversing procedures, look behind you and down for small children.
- Never allow children to ride along. They can fall off and seriously injure themselves or be in the way for safe manoeuvring of the machine.
- Never allow children to operate the machine.

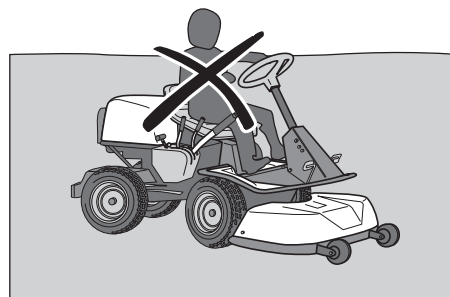

- Be particularly careful near corners, bushes, trees or other objects that block your view.

# SAFETY INSTRUCTIONS

## Maintenance

- Before carrying out repair work, cleaning or inspection, the machine must be in standstill and turned off. Remove the ignition key.
- Electrical shocks can cause injuries. Do not touch cables or contacts when the machine is running.
- Never wear jewellery, watches or similar when cleaning, carrying out repair work on or inspecting the machine.
- Make sure all nuts and bolts are tightened correctly and that the equipment is in good condition.
- Do not modify safety equipment. Check regularly to be sure it works properly. The machine must not be driven if protective plates, protective covers, safety switches or other protective devices are not fitted or are defective.
- Observe the risk of injury caused by moving or hot parts if the engine is started with the engine cover open or protective cowlings removed.
- Stop and inspect the equipment if you run over or into anything. If necessary, make repairs before starting.
- Never make adjustments with the machine running. Turn the ignition key to the "0" position and remove the ignition cable from the battery terminal.
- The machine is tested and approved only with the equipment originally provided or recommended by the manufacturer.
- The blades are sharp and can cause cuts. Wrap the blades or wear protective gloves when handling them.
- Check regularly that the parking brake works. Adjust and maintain as required.
- Reduce the risk of fire by removing grass, leaves and other debris that may have fastened on the machine. Allow the machine to cool before putting it in storage.

## Transport

### IMPORTANT INFORMATION

The parking brake is not sufficient to lock the machine during transport. Ensure you secure the machine firmly to the transporting vehicle.

- The machine is heavy and can cause serious crush injuries. Take extra care when loading it onto or off a vehicle or trailer.
- Use an approved trailer to transport the machine.  
To secure the machine on the trailer, two approved tension belts and four wedge shaped wheel blocks should be used.  
Engage the parking brake and tie the tension belts around stable parts on the machine, e.g. frame or rear wagon. Secure the machine by tensioning the belts towards the back and the front of the trailer respectively.  
Place the wheel blocks in front of and behind the rear wheels.
- Check and observe local road traffic regulations before transporting or driving the machine on roads.

## Battery



**WARNING! Be especially careful when handling battery acid. Acid on the skin can cause serious corrosive injuries. In the event of spillage on the skin wash immediately with water.**

**Batteries emit explosive gas. Sparks, flames and cigarettes must absolutely not be brought into the vicinity of the battery.**



**WARNING! The battery contains lead and lead pollutants, chemicals that are considered to cause cancer, birth defects or other reproductive impairment. Wash your hands after touching the battery.**



**WARNING! Never connect the battery terminal to keys, coins, screws or other metal as this may short-circuit the battery. Unused batteries must be kept away from metal objects such as nails, coins, jewellery.**

- Acid in the eyes can cause blindness. Rinse immediately with plenty of water for at least 20 minutes and contact a doctor immediately.
- Be especially careful when handling battery acid. Acid on the skin can cause serious corrosive injuries. In the event of spillage on the skin wash immediately with water.
- Battery acid fumes which are inhaled cause damage to mucous membranes and other organs. Contact a doctor if acid fumes are inhaled.
- A damaged battery must always be replaced. Battery replacement must only be performed by an authorized servicing dealer.
- Faulty or old batteries must not be disposed of with the rubbish. Contact the local authorities for correct waste management.
- Take care with battery maintenance. Explosive gases form in the battery. Never perform maintenance on the battery while smoking or in the vicinity of open flames or sparks. This can cause the battery to explode and cause serious injuries.

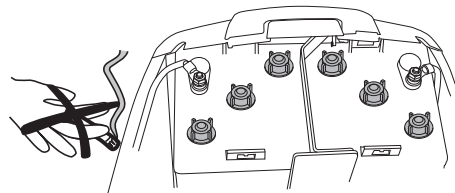



# WHAT IS WHAT?

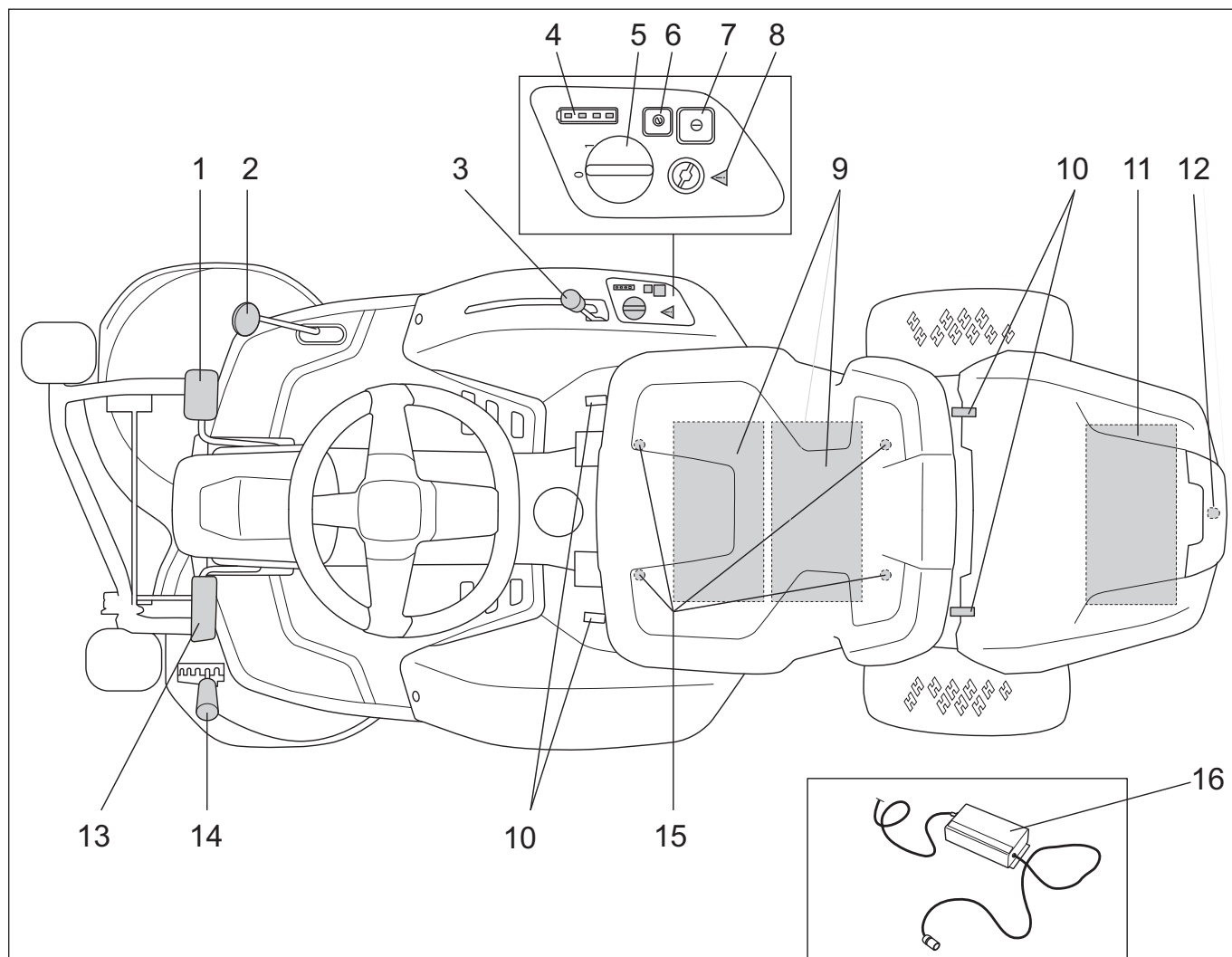

## Location of the controls

- |                                      |  |
|--------------------------------------|--|
| 1 Speed limiter for driving forward  | 9 Front batteries                            |
| 2 Speed limiter for reversing        | 10 Cover lock                                |
| 3 Lifting lever for the cutting unit | 11 Rear battery                              |
| 4 Battery status                     | 12 Socket for connecting the battery charger |
| 5 Ignition key                       | 13 Parking brake                             |
| 6 Battery saving function (SavE)     | 14 Cutting height adjustment lever           |
| 7 Start button                       | 15 Seat adjustment                           |
| 8 Warning light                      | 16 Battery charger                           |

# PRESENTATION

## Presentation

Congratulations on your choice of an excellent quality product that will give you great pleasure for many years.

The Rider Battery is a battery-powered ride-on mower. The engines are powered by 3 batteries connected in series.

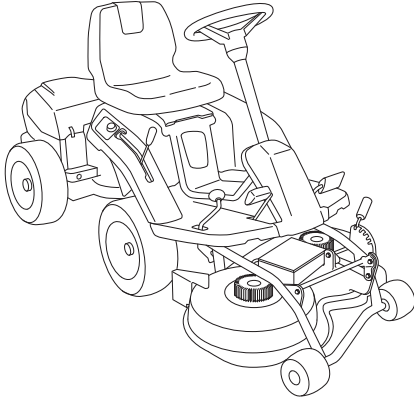

## Brake pedal / Parking brake

The brake pedal engages a disc brake that is located on the drive engine and stops the drive wheels.

### Parking brake

The parking brake is applied as follows:

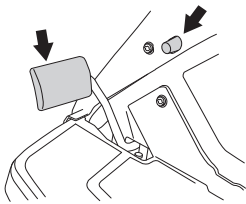

- 1 Press down the parking brake pedal.
- 2 Press in the lock button on the steering column.
- 3 Release the parking brake pedal while keeping the button pressed in.

The parking brake lock disengages automatically when the brake pedal is pressed.

## Speed limiter

The speed of the machine is steplessly regulated with two pedals. Pedal (1) is used to drive forwards, and pedal (2) to drive backwards.

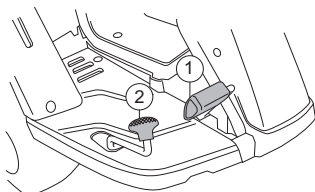

Pressing down both pedals stops the machine. Release both pedals and then press down the required pedal.



**WARNING! Make sure that branches do not obstruct the pedals when mowing under bushes. Otherwise there is a risk you may lose control.**

## Cutting unit

The machines are equipped with a 2-blade BioClip cutting deck. The BioClip plug finely chops the cuttings to fertiliser. Without the BioClip-plug the unit works in the same way as a rear ejection unit.

The blades are run by two electric motors which are attached to the cutting deck.

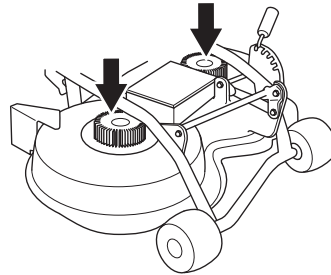

**WARNING! Rotary blades Never touch the blades before the machine is turned off, the ignition key is removed and the blades have stopped rotating.**

## Lifting lever for the cutting unit

The lift lever is used to set the cutting unit in transport or mowing position.

If the lever is pulled backwards the unit is raised and the blades automatically stop rotating (transport position).

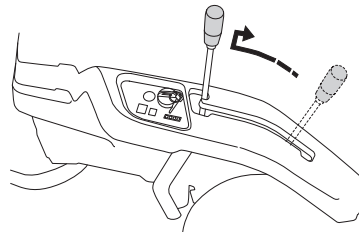

If the lever is moved forwards, the cutting deck will be lowered and the blades will automatically start to rotate (mowing position).

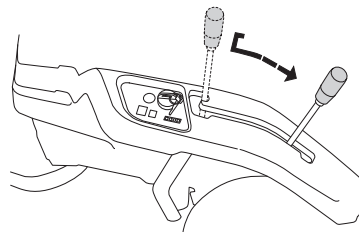

The lever can also be used to temporarily regulate the cutting height, e.g. for a small mound in the lawn.

# PRESENTATION

## Cutting height adjustment lever

The cutting height can be adjusted to 5 different positions with the cutting height lever.

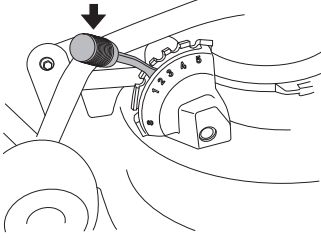

Lift up the cutting unit before adjusting the height.

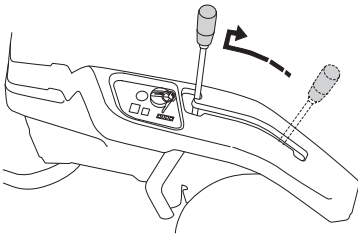

## Seat

The seat has a jointed attachment on the front edge and can be tipped forward.

The seat can also be adjusted lengthways.

Loosen the bolts under the seat and adjust it forwards or backwards to the desired position.

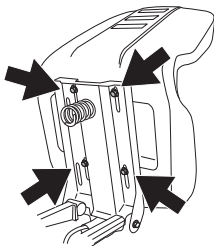

Tighten the bolts after adjusting.

## Battery

The batteries must be recharged using the battery charger supplied.

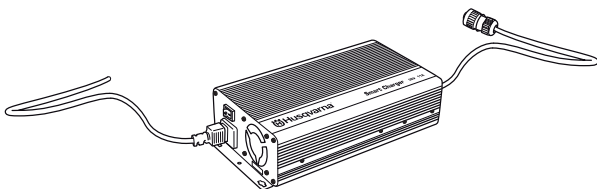

If the battery is flat, it takes around 16 hours to fully charge it.

Always charge the batteries when the Rider is not in use. In this way the batteries are always fully charged when the machine is to be used.

The charger is plugged into the charging socket at the rear of the machine under the charging cover.

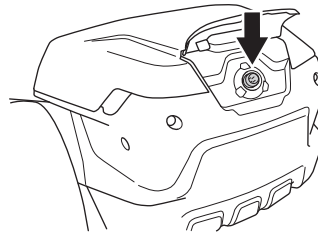

When the battery is fully charged, the charger goes into maintenance charging mode.

The machine cannot be used when it is connected to the charger.

Store the charger in a dry area when it is not being used. When charging, the charger must be placed in a well ventilated area and under a roof to keep out moisture.

The instrument panel has a battery indicator which indicates battery status.

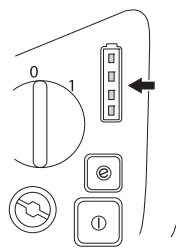

When all LEDs are lit the battery is fully charged.

LED lights	Battery status
All LEDs are lit	Battery is 75%-100% charged
3 LEDs are lit	The battery is 50%-75% charged.
2 LEDs are lit	The battery is 25%-50% charged.
1 LED is lit	The battery is 0%-25% charged.

When the battery is low a red lamp lights up, and the blades stop rotating to save power. When the red lamp is lit on the battery indicator, the machine has to be driven to the charging station.

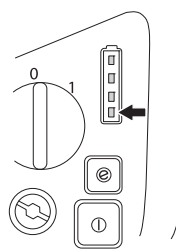

If the machine stops and has to be pushed to the charging station, the freewheel fuse in the rear carriage must be removed. Do not forget to put the fuse back in place before charging the battery.

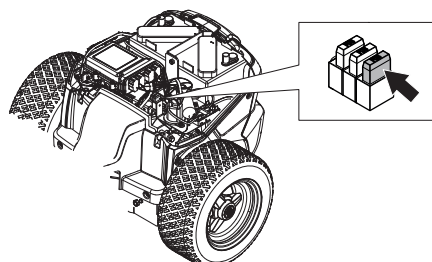

## Battery saving function (SavE)

The machine is equipped with a battery saving function which reduces propulsion speed.

Activate the saving function by pressing the saveE button. The savE button is lit solid green when the function is activated.

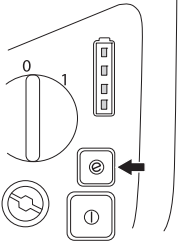

## Warning light

The warning lamp is fitted in the control panel.

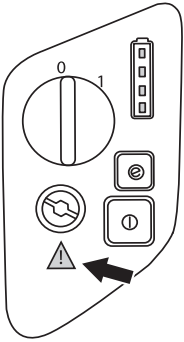

If a fault occurs in the machine, the lamp lights up red or flashes red.

If the warning symbol flashes, either the blades are blocked or the engine is overheated.

### Steps

- Inspect the blades from underneath. See the "Checking the blades" section.
- Turn off the machine and let it cool down.

When this does not help, contact an authorised service workshop.

If the warning symbol lights up solid red, there is a serious fault with engine control.

### Steps

- Contact an authorized servicing dealer.

# Driving

## Before starting

- Read the safety instructions and information concerning the placement of controls and functions before starting.
- Perform daily maintenance before starting as set out in the Maintenance schedule.
- Adjust the seat to the required position.
- Select the required cutting height (1-5) using the cutting height lever.

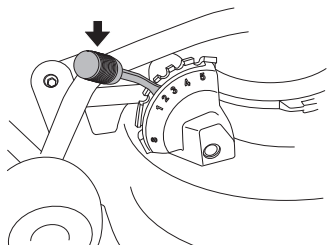

It is important that the air pressure in both front wheels is equal, 60 kPa / 0,6 bar / 8.5 PSI, to produce an even cutting height.

## Turn on the machine.

- 1 Disconnect the charging cable.

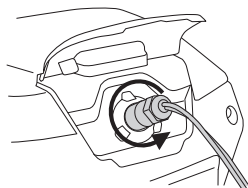

- 2 Sit on the seat.
- 3 Lift up the cutting unit by pulling the lever backwards to its locked position.

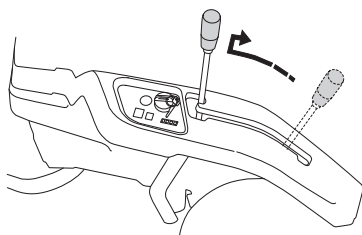

- 4 Activate the parking brake. This is done as follows:

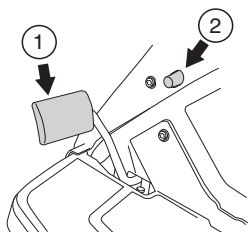

- Press down the parking brake pedal (1).
- Press in the lock button (2) on the steering column.
- Release the brake pedal while holding the button pressed.

The parking brake lock disengages automatically when the brake pedal is pressed.

The engine cannot be started unless the parking brake is pressed down.

- 5 Turn the ignition key to position 1. The start button then begins flashing green.

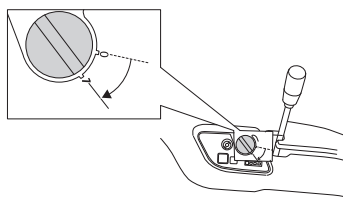

- 6 Push the start button. The start button lamp is solid green when the machine is running.

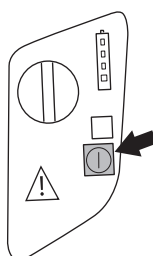

## Driving the Rider

- 1 Release the parking brake by first pressing down the parking brake pedal and then releasing it.

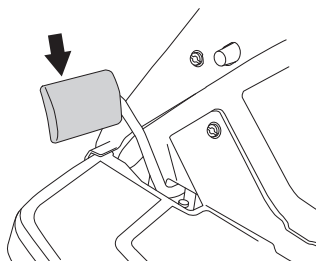

- 2 Lower the cutting unit.

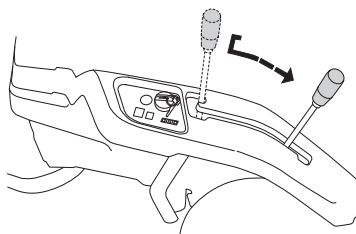

- 3 Carefully press down one of the pedals until the required speed is obtained. Pedal (1) is used to drive forwards, and pedal (2) to drive backwards.

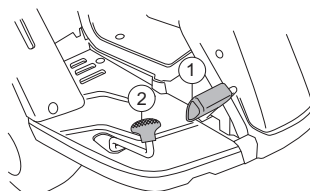

# Driving

## Cutting tips

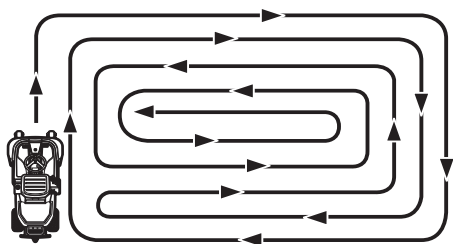

**WARNING! Clear the lawn from stones and other objects which can be thrown out by the blades.**

- Localise and mark stones and other fixed objects to avoid collision.
- Start with a high cutting height and reduce down until the required mowing results are obtained. If the grass is not too high and thick, the driving speed can be increased without noticeably depreciating the mowing result.
- The best lawns are achieved if the grass is cut often. Mowing becomes more uniform and the grass cuttings become more evenly distributed over the surface. The total time consumption is not greater since it is possible to select a higher driving speed without inferior mowing results.
- Avoid mowing a wet lawn.
- Hose down the cutting unit with water underneath each time it is used.
- When the BioClip function is used, it is very important that the mowing interval is not too long.



**WARNING! Do not use the machine on ground that slopes more than 10°. Mow slopes upwards and downwards, never across. Avoid sudden changes in direction.**

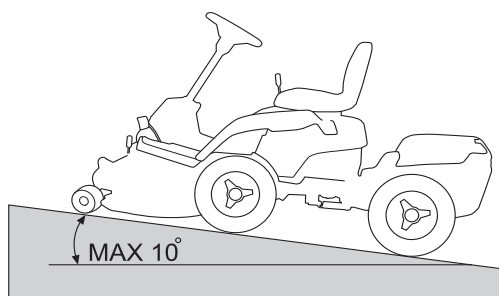

## Stopping

- 1 Lift up the cutting unit by pulling the lever backwards to its locked position.

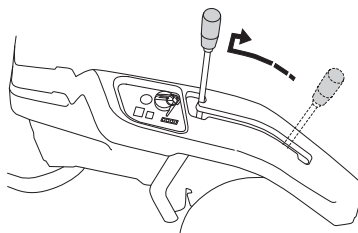

- 2 When the Rider is at a standstill, press down the parking brake and push in the locking button.

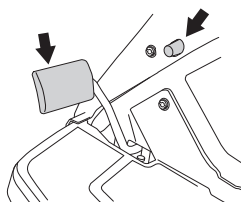

- 3 Turn off the machine by turning the ignition key to the "0" position.

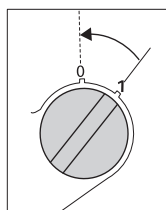

# Maintenance

## Maintenance schedule

The following is a list of the maintenance which should be conducted on the machine. For those points not described in this manual, visit an authorised service workshop.

Maintenance	Daily maintenance before starting	At least once a year	Maintenance interval in hours			
			25	50	100	200
Cleaning	X					
Check the steering wires	X					
Check the brakes	X					
Check the battery acid level and condition.	X					
Check the safety system	X					
Check nuts and screws	O					
Check the electrical cables and connections.			O			
Check the cutting deck			X			
Check the tyre pressures.			X			
Lubricate joints, shafts and chain			X			
Check/adjust parking brake				X		

X = Described in this operator's manual

O = Not described in this operator's manual



**WARNING! No service procedures must be conducted on the engine or cutting unit unless:**

**The machine is turned off**

**The ignition key has been removed from the ignition and the electrical cable is disconnected from the battery terminal.**

**The parking brake is applied.**



**WARNING! Never wear jewellery, watches or similar when cleaning, carrying out repair work on or inspecting the machine.**

# Maintenance

## Cleaning

Clean the machine directly after use. It is much easier to wash off grass cuttings before they dry.



Oily dirt can be removed using a cold degreasing agent. Spray on a thin layer.

Rinse at normal water pressure. Do not use a high pressure washer to clean the machine.

Do not direct the jet towards electrical components or bearings.

Hose down the cutting unit with water underneath each time it is used. It is recommended that you start the machine and run the cutting deck for a short period after cleaning, so that any remaining water is blown off.

Lubricate the machine if necessary after cleaning. Carry out extra lubrication when the bearings have been exposed to a degreaser or a water jet.

**IMPORTANT!** Do not use a high pressure washer to clean the machine. There is a major risk of water penetrating into bearings and electrical connections. Corrosion attack can result, which will lead to running problems. Cleaning additives generally aggravate the damage.

## Removing of the machine hoods

### Battery covers

The batteries are accessible for service when the battery covers are removed.

The two front batteries are located under the seat.

Loosen the two snap locks, fold back the seat and remove the cover.

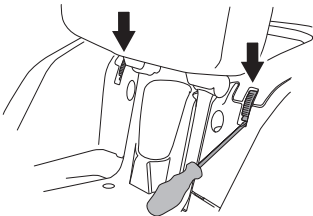

When fitting the cover, its hooks must be inserted into the rear slots.

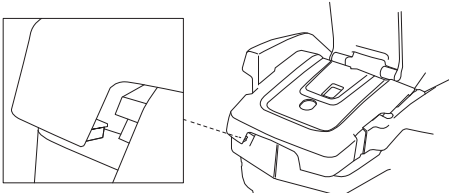

One battery is stored in the rear carriage.

Loosen the snap locks (one on each side) and remove the cover entirely.

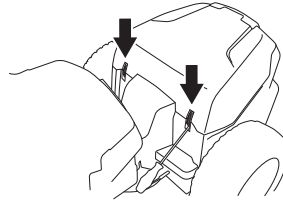

When fitting the cover, its hooks must be inserted into the rear slots.

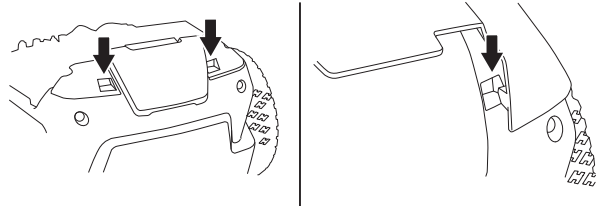

Make sure the cover's guide pins align with the slots and then close the snap locks.

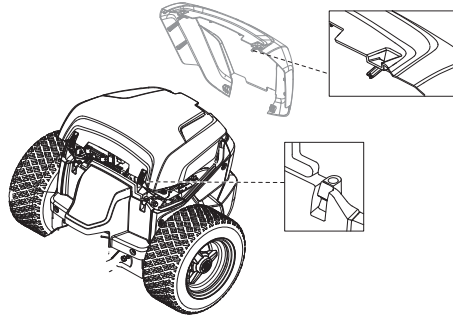

### Right-hand fender

Remove the screws and the back pedal knob, and lift off the cover.

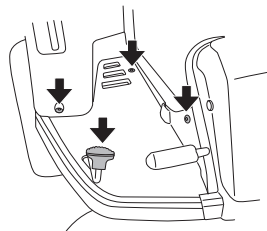

### Left-hand fender

Loosen the screws holding the wing cover and lift off the cover.

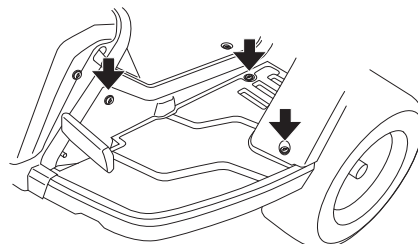



# Maintenance

## Checking and adjusting the steering wires

The steering is controlled by means of wires. These can in time become slack, which implies that the adjustment of the steering becomes altered.

Check and adjust the steering as follows:

- 1 Remove the frame plate by loosening the screws.

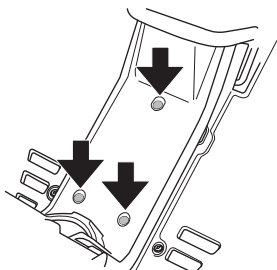

- 2 Check the tension of the steering wires by squeezing them together by the arrows as illustrated.

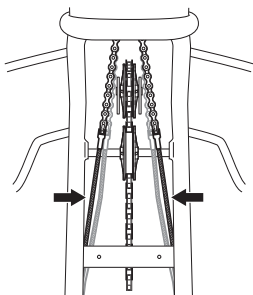

- 3 If necessary, the wires can be adjusted by tightening the adjuster nuts on each side of the steering collar. Do not over tighten the cables; they should only be drawn in towards the steering collar.

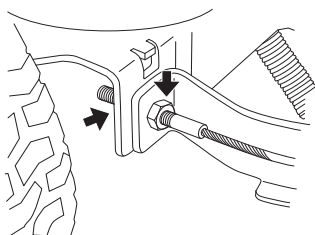

Hold the cable, for example using an adjustable wrench, so that it does not twist.

If you only tension one side the steering wheel's centre position may change.

Check the wire tension on completion of the adjustment as per item 2.

## Checking the brake

The brake is a disc brake and is attached to the drive motor.

Check that the brake is correctly adjusted by placing the machine on a slight downhill slope and engaging the brake.

If the machine does not stand still, the brake must be adjusted by an authorised servicing dealer.

## Check the level of the battery acid



**WARNING! Be especially careful when handling battery acid. Acid on the skin can cause serious corrosive injuries. In the event of spillage on the skin wash immediately with water.**

**Batteries emit explosive gas. Sparks, flames and cigarettes must absolutely not be brought into the vicinity of the battery.**

The machine has three batteries connected in series. One battery is located in the rear carriage and two batteries are located under the seat.

Loosen the snap lock and lift off the battery covers.

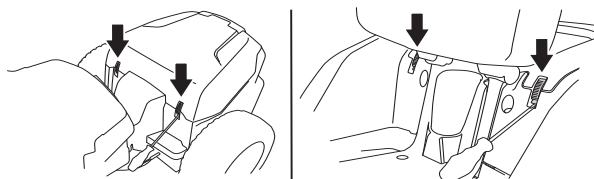

Unscrew the battery lids and check that the battery acid just covers the battery cells.

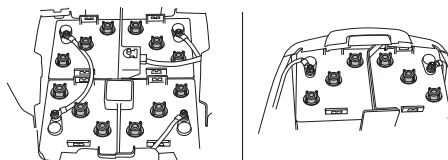

Check that the battery acid level reaches up to the level pin.

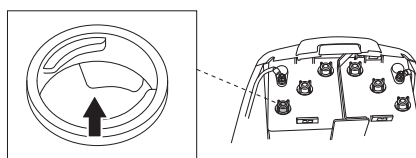

Top up the cells with distilled water only.

## Charging the batteries

Make a habit of always charging the battery when the machine is not in use. In this way the machine is always ready to use. When the battery is fully charged, the charger goes into maintenance charging mode.

Improperly used, broken or a faulty battery charger can cause an electric shock, overheating or battery acid leakage.

The batteries must be recharged using the battery charger supplied.

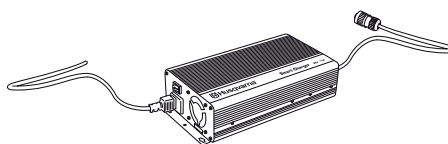

- Charging should be carried out in the ideal surrounding temperature from 0 to 40°C
- Do not charge at temperatures below 0° C.
- Do not charge the battery in direct sunlight.
- Keep the charger out of reach of children.

# Maintenance

- 1 Make sure that the power switch is in the 0 position.

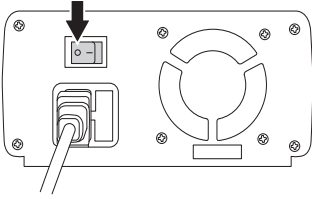

- 2 Connect the battery charger to the voltage and frequency specified on the charger's type plate. When the battery charger is connected to the grid, a green lamp lights up on the battery charger.

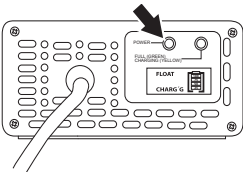

- 3 Open the charging cover.

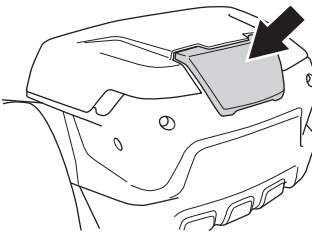

- 4 Connect the charger to the battery socket. The plug and socket fit only one way. Press in the plug and lock it in place.

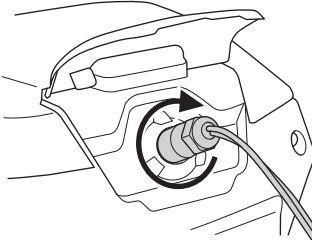

Turn on the charger by pressing the power switch.

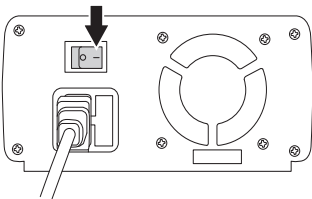

The display on the battery charger indicates how much the battery is charged.

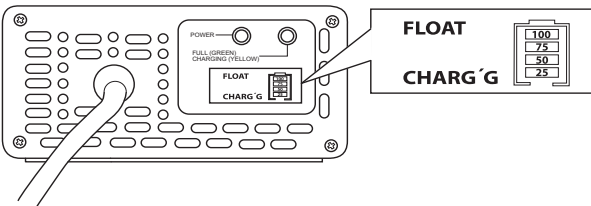

The acid level in the float battery must be checked after charging and topped up with distilled water if necessary. See the "Checking the battery acid level" section.

## Checking the tyre pressure

The tyre pressure should be 60 kPa / 0.6 bar / 9 PSI on all wheels. In order to improve drive power, the pressure in the rear tyres can be reduced to 40 kPa / 0.4 bar / 6 PSI.

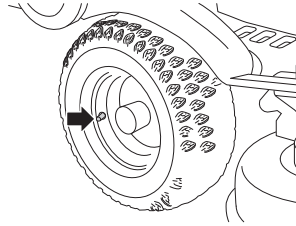

**IMPORTANT INFORMATION** Different tyre pressures on the front tyres will result in the blades cutting the grass at different heights.

## Fuses

The main fuse is located under the rear battery cover.

The fuse is a 150 A melt fuse.

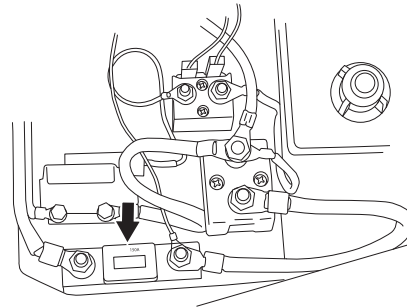

The fuse holder also houses three other fuses.

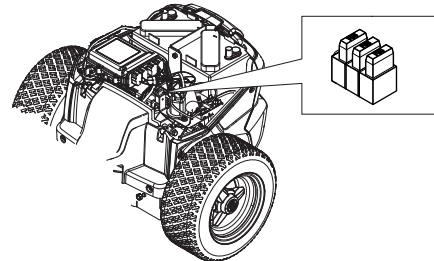

- One for the charging circuit.
- One for the freewheel circuit.
- One for the cutting deck.

Do not use any other type of fuse when replacing.

A blown fuse is indicated by a burnt connector. Pull the fuse from the holder when replacing.

The fuse is there to protect the electrical system. If it blows again shortly after replacement, it is due to a short circuit, which must be fixed before the machine can be put into operation again.

### Fuse on the battery charger.

A glass fuse is fitted to the battery charger.

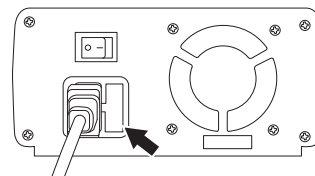

# Maintenance

## Check the safety system

The machine is equipped with a safety system that prevents starting or driving under the following conditions.

The machine can only be started when:

- The parking brake is depressed and the operator sits on the seat.

The engine must stop when:

- The cutting deck is lowered and the driver rises from the seat.
- The cutting deck is in its raised position, the parking brake is not applied and the driver rises from the seat.

Check daily to ensure that the safety system works by attempting to start the engine when one of the conditions above is not met. Change the conditions and try again.

## Removing the cutting unit

The cutting deck can be removed in order to facilitate cleaning and servicing.

To remove the cutting deck proceed as follows:

- 1 Position the machine on flat ground.
- 2 Turn off the machine and remove the ignition key.
- 3 Apply and lock the parking brake.

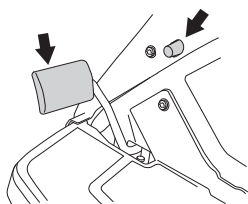

- 4 Check that the lever for setting the cutting height is in the S position.

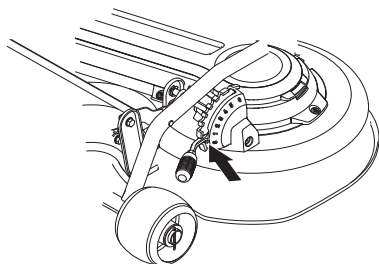

- 5 Lower the cutting unit.

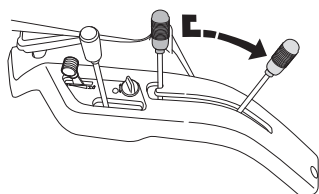

- 6 Loosen the snap lock for the covers on the cutting deck and loosen the cables. There are 2 for each motor.

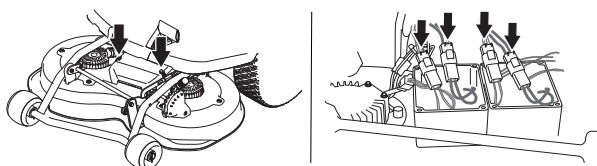

- 7 Grasp the upper pipe framework in the cutting deck and the cutting deck lock at the same time, and pull out the cutting deck.

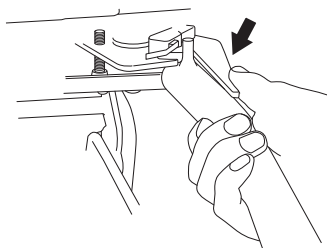

- 8 Lift off the deck and lean it against the machine or a wall.

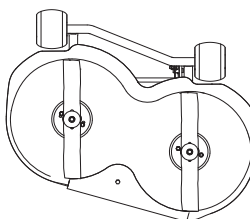

## Fitting the cutting head

- 1 Push the cutting deck in and make sure the guide bolts fit into the grooves on the deck frame, one on each side.

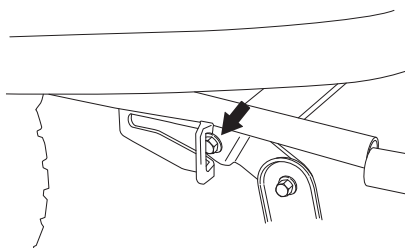

- 2 Fit the cutting deck's pipe together with the deck frame's pipe.

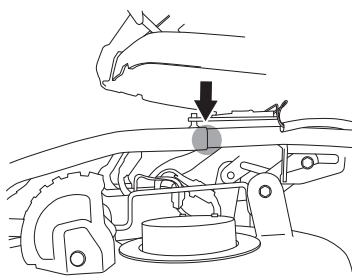

- 3 Press in the lock, grasp the pipes and slide in the cutting deck.

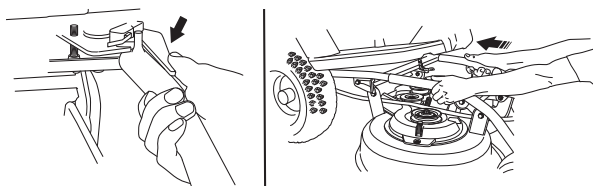

- 4 Push the deck until you feel the pipes touch bottom.

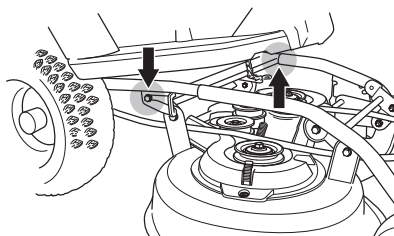

# Maintenance

- 5 Connect the cables and fit the cover.

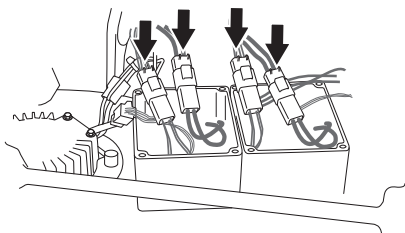

- 6 Set the cutting deck height control in any of the positions 1-5.

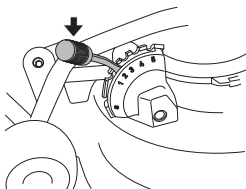

## Checking the cutting unit's parallelism

Check the cutting unit's parallelism as follows:

- 1 Check the air pressure in the tyres 60 kPa / 0.6 bar / 9 PSI.
- 2 Place the machine on a flat surface.
- 3 Measure the distance between the ground and the front and rear edges of the cutting unit hood.

The cutting deck must have a slight tilt, with the rear edge 5-7 mm (1/5-1/4") higher than the front edge.

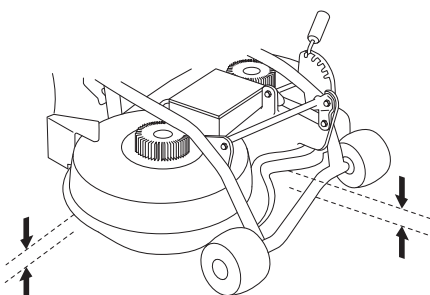

## Adjusting the parallelism of the cutting unit

- 1 Check the air pressure in the tyres 60 kPa / 0.6 bar / 9 PSI.
- 2 Loosen the parallelism stay's nuts, the inner nut has a left-hand thread.

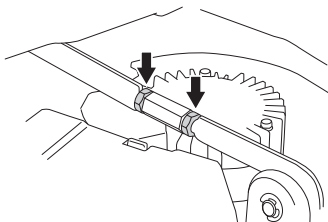

- 3 Screw out (extend) the strut to lower the rear edge of the cover.

Screw in (shorten) the strut to raise the rear edge of the cover.

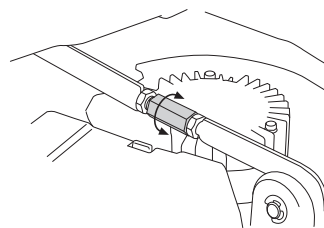

- 4 Tighten the nuts after adjustment.
- 5 On completion of the adjustment the unit's parallelism should be re-checked.

## Checking the blades

To achieve the best mowing results it is important that the blades are undamaged and well-sharpened.

Excessive vibration in the machine may be caused by damaged or loose blades.

- Remove the cutting deck. See the "Removing the Cutting Deck" section.
- Check that the blades' attachment screws are tight.
- Check that the blades are intact and not damaged.

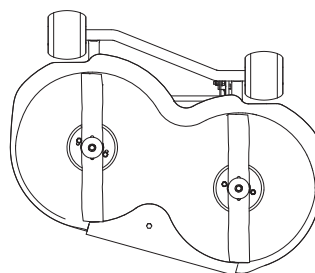

Damaged blades should be replaced when hitting obstacles that result in a breakdown. Let the service centre assess whether the blade can be sharpened or must be replaced.

The blades should be balanced after sharpening.

### IMPORTANT INFORMATION

Replacing or sharpening the blades should be conducted by an authorised service workshop.



**WARNING!** If the blades are cracked, whether caused by poor repair or other damage, they could break while being used. The risk increases if the blades are poorly balanced.

---

# Maintenance

---

## Removing the BioClip plug

To change a BioClip deck from the BioClip function to a cutting deck with rear ejection, remove the BioClip plug, which is located under the cutting deck, attached with a screw.

- 1 Remove the cutting deck. See the "Removing the Cutting Deck" section.
- 2 Loosen the screw holding the plug and remove it.

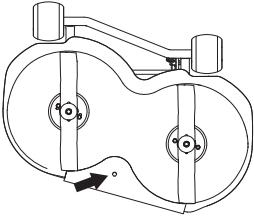

- 3 Fit cutting unit.
- 4 Fit the BioClip plug in the reverse order.

## Lubrication of drive chain

Remove the cover. It is secured with four screws. Two on each side.

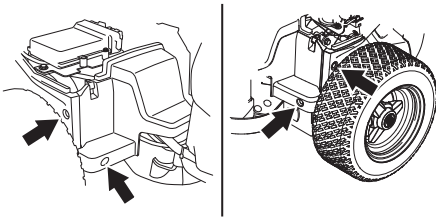

Lubricate the chain with engine oil or other good quality oil.

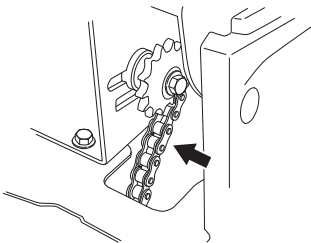

## General lubrication

All joints and bearings are lubricated using molybdenum disulphide grease during manufacture. Continue to lubricate using the same type of grease \*. Lubricate the steering and control wires using engine oil.

Carry out this lubrication regularly.

\*Grease from well-known brand names (petrochemical companies, etc.) usually maintains a good quality.

---

# Troubleshooting schedule

---

<b>Problem</b>	<b>Procedure</b>
<b>Warning lamp on the control panel lights up solid red.</b>	Contact an authorized servicing dealer.
<b>Warning lamp on the control panel flashes red.</b>	The blades are blocked: Remove the cutting deck and check that the blades move freely. Engine overheated: Turn off the machine and wait until the motor has cooled down.
<b>The machine cannot be started</b>	The batteries are not charged enough. The switches are not engaged (P-brake and seat switch). Forward/back pedal depressed. The charging socket is in the machine. Main fuse blown (150 A). Operator panel broken (bring to servicing dealer) The switch in the ignition is faulty (bring to servicing dealer) CCU or contacts are faulty (bring to servicing dealer)
<b>The operator panel does not light up when the key is turned</b>	The batteries are not charged enough. Blown 5 A fuse Main fuse blown (150 A). CCU or contacts are faulty (bring to servicing dealer) The switch in the ignition is faulty (bring to servicing dealer) Operator panel broken (bring to servicing dealer)
<b>The cutting deck does not work</b>	Check that the bottom of the cutting deck is clean (not full of grass). Check that the blades can rotate freely (disconnect the machine from power, remove battery terminals) The batteries are not charged enough. The cutting deck fuse is blown (80 A). Check the cables between the machine and the cutting deck. Check that the safety switch by the equipment frame is engaged (pressed in) Check the safety switch by the lifting lever. The cutting deck motor is faulty. The cutting deck motor control is faulty.
<b>The machine does not charge</b>	The charger is not connected correctly. The charger is faulty Blown fuse (15 A) Low battery acid level One or more battery cells faulty Poor contact with battery terminal cable connectors.
<b>Turned off machine with disengaged P-brake rolls easily</b>	Blown fuse (30 A)
<b>Machine vibrates</b>	Blades are loose A cutting deck motor is loose. One or more blades unbalanced, caused by damage or poor balancing after sharpening
<b>Uneven mowing</b>	Blades blunt Long or wet grass Cutting unit set incorrectly, check parallelism. Grass blockage under hood Different tyre pressures on right and left sides Driving speed too high - activate savE Cutting height too low

---

# Storage

---

## Winter storage

At the end of the season, or if the machine is going to stand idle for more than 30 days, it should immediately be made ready for storage.

To prepare the machine for storage follow these instructions:

- 1 Carefully clean the machine, especially under the cutting unit. Touch-up paint damage to avoid rust.
- 2 Inspect the machine for worn or damaged parts and tighten loose screws and nuts.
- 3 Lubricate all joints and shafts.
- 4 Clean and maintenance charge the battery.
- 5 Store the ride-on mower in a frost-free, clean, dry place and cover it for extra protection.

## Guard

There is a cover to protect your machine during storage or transport. Contact your dealer for a demonstration

## Service

Low season is the most suitable time to perform a service or overhaul of the machine in order to ensure high function safety during high season.

When ordering spare parts state your machine's purchase year, model, type, and serial number.

Always use genuine parts.

An annual check-up by an authorised servicing dealer is a good way to ensure that your ride-on mower performs at its best the following season.

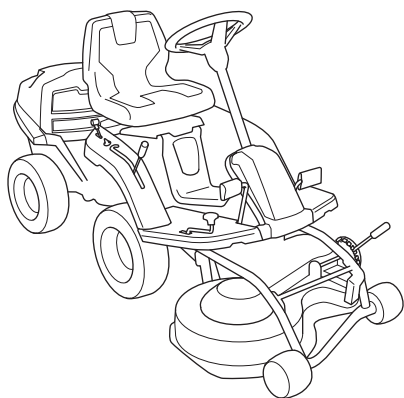



# TECHNICAL DATA

	Rider Battery
<b>Dimensions</b>	
Length without cutting unit, cm/in	174/5.7
Length with cutting unit, cm/ft	208/6.8
Width without cutting unit, cm/in	79/2.6
Width with cutting unit, cm/ft	89 / 2,92
Height, cm/ft	106/3.5
Operating weight with cutting deck, kg/lb	270/595
Wheel base, cm/ft	80/2.62
Tyre dimensions	155/50-8
Air pressure, rear - front, kPa / bar / PSI	60 (0,6/8,5)
<b>Drive motor</b>	
Engine type	Brushless DC engine
Voltage, V	36
Nominal engine output, kW	1.5
Max.motor speed, r/min	3000
<b>Blade motors</b>	
Engine type	Brushless DC engine
Voltage, V	36
Nominal engine output, kW	0.8
Max.motor speed, r/min	3600
<b>Electrical system</b>	
Type	36 V, negative grounded
Main fuse, A	150
Cutting deck fuse, A	80
Charging fuse, A	15
Key switch fuse, A	5
Freewheel fuse, A	25
<b>Battery</b>	
Type of battery	Open lead acid
Voltage, V/Ah	3x (12 V/135 Ah)
Weight, kg/pce.	40
<b>Noise emissions and cutting width</b>	
(see note 1)	
Sound power level, measured dB (A)	93
Sound power level, guaranteed dB(A)	95
Cutting width, cm/inch	85/33,5
<b>Sound levels</b>	
(see note 2)	
Sound pressure level at the operators ear, dB(A)	82
<b>Vibration levels</b>	
(see note 3)	
Vibration level on the steering wheel, m/s <sup>2</sup>	0,4
Vibration level in the seat, m/s <sup>2</sup>	0,1
<b>Transmission</b>	
Brand	Topec T7100
Lubricant	SAE 80W-90
Forward speed, km/h.	0-8
Reverse speed, km/h	0-5
<b>Cutting unit</b>	
Type	BioClip unit
Cutting heights, 5 positions, mm/inch	25-70 / 1-2 3/4
Blade length, mm/inch	430/17

Note 1: Noise emissions in the environment measured as sound power ( $L_{WA}$ ) in conformity with EC directive 2000/14/EC.

Note 2: Noise pressure level according to EN 836. Reported data for noise pressure level has a typical statistical dispersion (standard deviation) of 1.2 dB(A).

Note 3: Vibration level according to EN 836. Reported data for vibration level has a typical statistical dispersion (standard deviation) of 0.2 m/s<sup>2</sup> (steering wheel) and 0.8 m/s<sup>2</sup> (seat).



---

## TECHNICAL DATA

---

**IMPORTANT INFORMATION** When the service life of this product has been served and it is no longer used it should be returned to the dealer or to an applicable station for recycling.

**IMPORTANT INFORMATION** We reserve the right to change specifications and designs without prior notice so as to implement improvements. Note that no legal claims are valid on the basis of information in this manual. Use only genuine parts for repairs. The warranty is not valid if non genuine parts are used.

---

# TECHNICAL DATA

---

## EC-declaration of conformity (Applies to Europe only)

Husqvarna AB, SE-561 82 Huskvarna, Sweden, tel.: +46 (0) 36 14 65 00, declares that the ride-on mower, Husqvarna Rider Battery, from 2012's serial numbers and onwards (the year is clearly stated on the rating plate followed by the serial number), complies with the requirements of THE COUNCIL'S DIRECTIVE:

of May 17, 2006 "relating to machinery" **2006/42/EC**

of December 15, 2004 "relating to electromagnetic compatibility" **2004/108/EC**.

of May 8, 2000 "relating to the noise emissions in the environment" **2000/14/EC**.

Information regarding noise emissions and the mowing width, see Technical data

The following harmonised standards have been applied: **EN ISO 12100-2, EN-836, EN ISO 14982 6.1, 6.2.**

**0404, SMP Svensk Maskinprovning AB**, Fyrisborgsgatan 3, SE-754 50 Uppsala, has issued reports regarding the assessment of conformity according to annex VI of the COUNCIL'S DIRECTIVE of May 8, 2000 "relating to the noise emissions in the environment" 2000/14/EC.

The certificates have the numbers: 01/901/158

Huskvarna January 18, 2012



Claes Losdahl, Development Manager/Garden Products (Authorized representative for Husqvarna AB and responsible for technical documentation.)



**Original instructions**  
**1154892-26**



**2012-04-02**