

Operator's manual
R 418Ts
R 418Ts AWD

Please read the operator's manual carefully and make sure you understand the instructions before using the machine.



English

CONTENTS

Contents

CONTENTS	
Contents	2
Service journal	
Pre-delivery service	3
After the first 8 hours	3
INTRODUCTION	
Dear Customer,	4
Driving and transport on public roads	4
Towing	4
Use	4
Good service	4
KEY TO SYMBOLS	
Symbols	5
WHAT IS WHAT?	
Location of the controls	7
SAFETY INSTRUCTIONS	
Safety instructions	8
Driving on slopes	9
Children	10
Maintenance	10
Transport	11
PRESENTATION	
Presentation	12
Throttle trigger	12
Choke control	12
Speed limiter	12
Counter	12
Parking brake	12
Cutting unit	13
Lever for hydraulic lift of attachments	13
Mechanical Lifting Lever for Cutting Unit	13
Cutting height adjustment lever	13
Seat	14
Fueling	14
Lights and power outlet	14
Release lever	15
Driving	
Cutting tips	16
Before starting	16
Start the engine	16
Starting the engine with a weak battery	17
Driving the Rider	18
Braking	19
Stop the engine	19
Maintenance	
Maintenance schedule	20
Cleaning	22
Removing of the machine hoods	22
Checking and adjusting the steering wires	23
Adjusting the parking brake	23
Adjusting the parking brake	23
Checking and adjusting of throttle wire	24
Checking and adjusting the choke wire	24
Replacement of fuel filter	24
Checking the fuel pump's air filter	24
Checking the transmission's air intake	25
Replacing the air filter	25
Ignition system	25
Cleaning the engine and muffler	26
Check the safety system	26
Replacing the light bulbs	26
Main fuse	26
Checking the tyre pressure	27
Checking the engine's cooling air intake	27
Replacing the rear drive belt R 418Ts	27
Replacing the hydraulic pump's drive belt R 418Ts AWD	28
Replacing the centre belt	29
Replacing the front belt	30
Fitting the cutting head	30
Removing the cutting unit	31
Checking and adjustment of the cutting unit's ground pressure	31
Checking the cutting unit's parallelism	31
Adjusting the parallelism of the cutting unit	32
Replacing the cutting unit belts	32
Service position for the cutting unit	33
Checking the blades	34
Removing the BioClip plug	34
Lubrication	
General	35
Accessories	35
Lubricating the cables	35
Chains in the frame tunnel	35
Links and joints in the cutting adjustment	35
Driver seat	36
Throttle and choke cables, lever bearings	36
Lubricating the belt adjuster	36
Checking the engine's oil level.	36
Lubricate the hydrostatic cable with links	37
Changing the oil filter	37
Hydraulic oil filter change	38
Lubricate the parking brake wire	38
Checking the transmission oil level	38
Troubleshooting schedule	
ELECTRICAL AND HYDRAULIC SYSTEMS	
.....	40
Hydraulic System	41
Storage	
Winter storage	42
Guard	42
Service	42
Technical data	
EC-declaration of conformity	45

Service journal

Pre-delivery service

- 1 Charge the battery for 4 hours at max. 3 amp.
- 2 Fit steering wheel, seat and any optional equipment.
- 3 Check and adjust tyre pressure. (60 kPa, 0.6 bar, 9 psi).
- 4 Adjust cutting unit:

Adjust lift springs (effective weight of cutting unit should be 12-15kg / 26.5-33 lb).

Adjust cutting unit so that rear edge is about 2-4 mm / 1/8" higher than front edge.

Adjust the cutting unit's cutting height setting so that the connection rod is tensed at the lowest cutting height.
- 5 Check that the right amount of oil is in the engine.
- 6 Check that there is oil in the transmission's oil tank.
- 7 Connect battery.
- 8 Fill with fuel and start engine.
- 9 Check that machine does not move in neutral.
- 10 Check:

Forward drive.

Reverse drive.

Operation of blades.

Seat safety switch.

Lif lever safety switch.

The safety switch for the hydrostat pedals.

11 Tell customer about:

Needs and benefits of following the service schedule.

Servicing and the influence of this journal on the second-hand value of the machine.

The transmission guarantee is only valid if the synchronisation of the front and rear wheels has been checked and adjusted in compliance with the service schedule. The system will be damaged if synchronisation is not carried out.

Range of applications for BioClip.

Complete proof of sale etc.

Pre-delivery service carried out. No outstanding problems. Certified:

Date, mileage, stamp, signature

After the first 8 hours

- 1 Change engine oil
- 2 Changing the gearbox oil (Only AWD-machines)

INTRODUCTION

Dear Customer,

Thank you for choosing a Husqvarna Rider. Husqvarna Riders are built to a unique design with a front-mounted cutting unit and a patented articulated steering. Riders are designed for maximum efficiency even in small or confined areas. The closely grouped controls and pedal-operated hydrostatic transmission also contribute to the performance of this machine.

This operator's manual is a valuable document. By following its instructions (on operation, service, maintenance, etc.) you will significantly extend the life of the machine and even its second-hand value.

When you sell your Rider, make sure you pass on the operator's manual to the new owner.

The last chapter in the operator's manual consists of a Service Journal. Make sure that all service work and repairs are recorded. A well-documented service history reduces the costs of seasonal maintenance and influences the second-hand value of the machine. Bring the operator's manual with the Rider when bringing it to a workshop for service procedures.

Driving and transport on public roads

Check the relevant road traffic regulations before driving the machine on a public road. If transporting the machine on another vehicle always use approved securing devices and make sure that the machine is securely held.

Towing

When your machine is equipped with a hydrostatic transmission you should only tow the machine over short distances and at a low speed, otherwise there is a risk of damaging the transmission.

The transmission must be disengaged when towing, see instructions under the heading Bypass valves.

Use

This ride-on mower is designed to mow grass on open and level ground surfaces. In addition, there is a number of accessories recommended by the manufacturer that broadens the application area. Please contact your dealer for more information about which accessories are available. The machine may only be used with the equipment recommended by the manufacturer. All other types of use are incorrect. Compliance with and strict adherence to the conditions of operation, service and repair as specified by the manufacturer also constitute essential elements of the intended use.

IMPORTANT INFORMATION The transmission guarantee is only valid if the synchronisation of the front and rear wheels has been checked and adjusted in compliance with the service schedule. The system will be damaged if synchronisation is not carried out.

This machine should be operated, serviced and repaired only by persons who are familiar with its particular characteristics and who are acquainted with the relevant safety procedures.

Accident prevention regulations, all other generally recognised regulations on safety and occupational medicine, and all road traffic regulations must be observed at all times.

Any arbitrary modifications carried out to this machine may relieve the manufacturer of liability for any resulting damage or injury.

Good service

Husqvarna products are sold all over the world and ensures that you, the customer, get the best support and service. For example, before this machine was delivered it was inspected and adjusted by your dealer. See the certificate in the Service Journal in this manual.

When you need spare parts or advice on service issues, warranty terms, etc., contact:

This Operator's Manual belongs to machine with serial number:	Engine	Transmission

On the machine's rating plate you will find the following information:

- The machine's type designation.
- The manufacturer's type number.
- The machine's serial number.

State the type designation and serial number when ordering spare parts.

KEY TO SYMBOLS

Symbols

These symbols are on the machine and in the instructions.

WARNING! Careless or incorrect use can result in serious or fatal injury to the operator or others.



Please read the operator's manual carefully and make sure you understand the instructions before using the machine.



Always wear:

- Approved hearing protection



This product is in accordance with applicable EC directives.



Fast



Slow



Stop the engine.



Choke.



Fuel



Oil level



Cutting height



Backwards



Forwards



Ignition



Hydrostatic freewheel

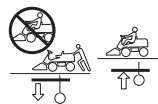

Parking brake



Noise emission to the environment according to the European Community's Directive. The machine's emission is specified in the Technical data chapter and on the label.



Clutch in



Clutch out



Hot surface.



Cover lock



Warning: rotating parts. Keep hands and feet clear.

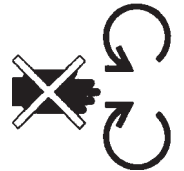

Rotary blades Keep hands and feet away from under the hood when the engine is running



Risk that the machine will tip over



Never drive across a slope



Never use the machine if persons, especially children, or animals, are in the vicinity



Never carry passengers on the machine or equipment



Drive very slowly if no cutting unit is fitted



Before and during reversing procedures, look behind you.

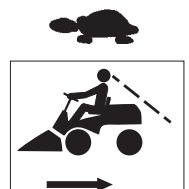

KEY TO SYMBOLS

Switch off the engine and take off the ignition cable before repairs or maintenance



Brake



Starting instructions

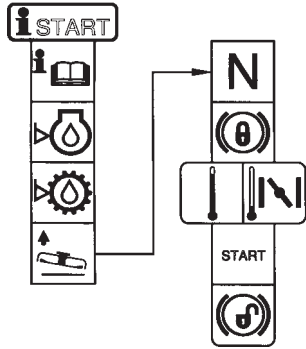

Check the engine's oil level



Check transmission oil level

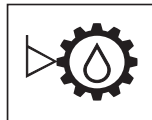

Lift up the cutting unit



Apply the parking brake.



If the engine is cold, use the choke

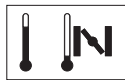

Release the parking brake before driving



WHAT IS WHAT?

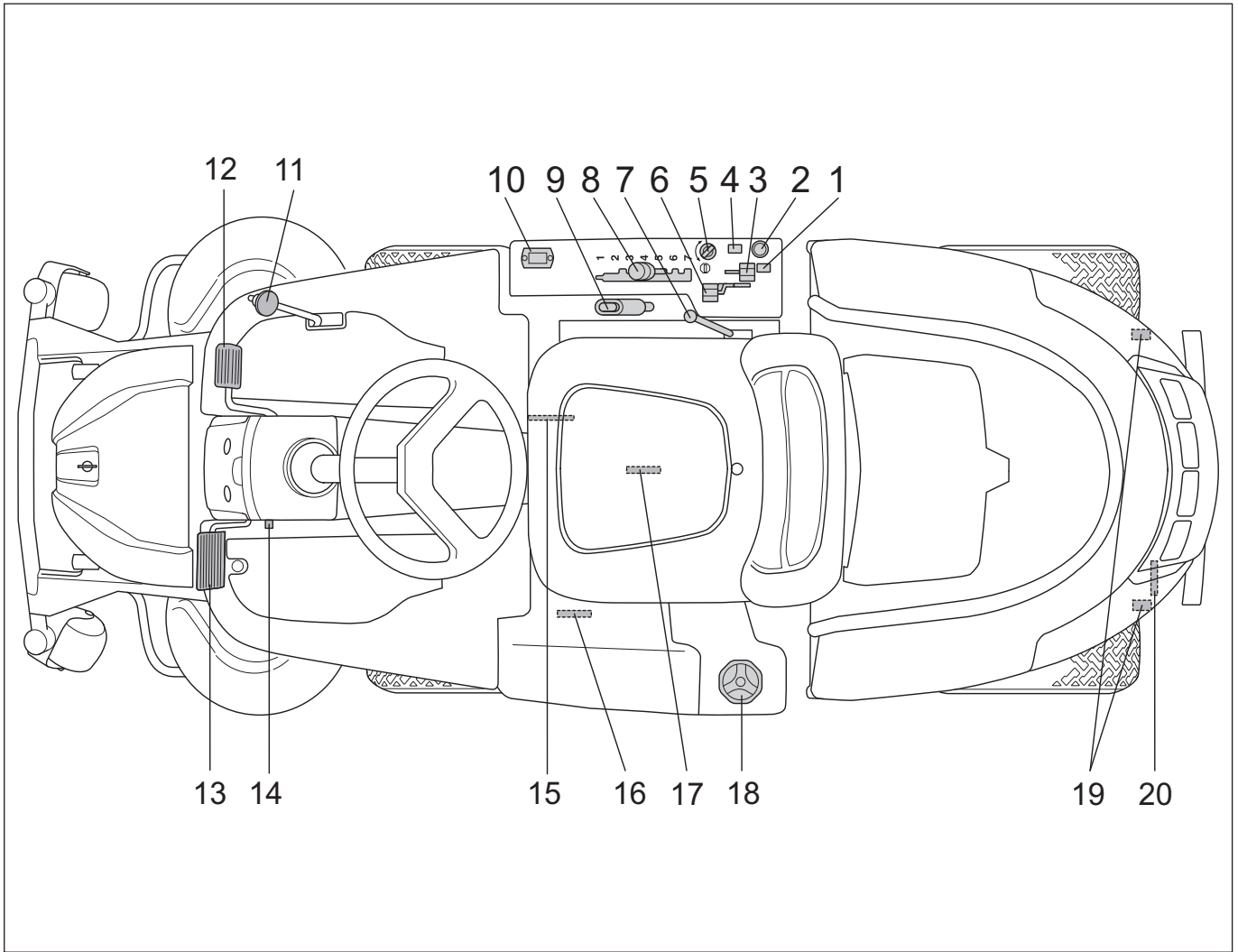

Location of the controls

- | | |
|---|--|
| 1 Switch for the power outlet | 11 Speed limiter for reversing |
| 2 Power outlet | 12 Speed limiter for driving forward |
| 3 Throttle trigger | 13 Parking brake |
| 4 Switch for the lights | 14 Lock button for parking brake |
| 5 Ignition lock | 15 Seat adjustment. |
| 6 Choke control | 16 Lever to disengage the driving front axle (Only AWD-machines) |
| 7 Lever for hydraulic lift of attachments | 17 Product and serial number plate |
| 8 Cutting height adjustment lever | 18 Fuel cap |
| 9 Mechanical Lifting Lever for Cutting Unit | 19 Cover lock |
| 10 Counter | 20 Lever to disengage the driving rear axle |

SAFETY INSTRUCTIONS

Safety instructions

These instructions are for your safety. Read them carefully.

Insure your Rider

- Check the insurance coverage for your new Rider.
- Contact your insurance company.
- You should have fully comprehensive insurance including: third party, fire, damage, theft and liability

General use

- Read all the instructions in this operator's manual and on the machine before you start it. Ensure you understand them and then observe them.

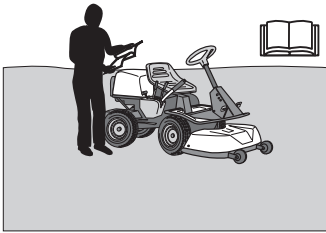

WARNING! This machine produces an electromagnetic field during operation. This field may under some circumstances interfere with active or passive medical implants. To reduce the risk of serious or fatal injury, we recommend persons with medical implants to consult their physician and the medical implant manufacturer before operating this machine.

- Learn how to use the machine and its controls safely and learn to how to stop quickly. Also learn to recognize the safety decals.
- Only allow the machine to be used by adults who are familiar with its use.
- Make sure nobody else is in the vicinity of the machine when you start the engine, engage the drive or drive off.
- Clear the area of objects such as stones, toys, wires, etc. that may become caught in the blades and be thrown out.



- Stop the engine and prevent the engine from being started until you have cleaned the outlet channel.
- Look out for the ejector and do not direct it towards anyone.
- Stop the engine and prevent it from starting before you clean the cutting unit.

- Remember that the driver is responsible for dangers or accidents.
- Never carry passengers. The machine is only intended to be used by one person.



- Always look downwards and backwards before and while reversing. Keep watch for both large and small obstacles.
- Slow before cornering.
- Switch off the blades when you are not mowing.
- Take care when rounding a fixed object, so that the blades do not hit it. Never run the machine over foreign objects.



WARNING! This machine can sever hands and feet as well as throw objects. Failure to observe the safety instructions can result in serious injuries.



WARNING! The inside of the muffler contain chemicals that may be carcinogenic. Avoid contact with these elements in the event of a damaged muffler.



WARNING! The engine emits carbon monoxide, which is a colourless, poisonous gas. Do not use the machine in enclosed spaces.

- Only use the machine in daylight or in other well-lit conditions. Keep the machine at a safe distance from holes or other irregularities in the ground. Pay attention to other possible risks.
- Never use the machine if you are tired, if you have consumed alcohol, or if you are taking other drugs or medication that can affect your vision, judgement or coordination.
- Keep an eye on the traffic when working close to a road or when crossing it.
- Never leave the machine unsupervised with the engine running. Always stop the blades, apply the parking brake, stop the engine and remove the keys before leaving the machine.

SAFETY INSTRUCTIONS

- Never allow children or other persons not trained in the use of the machine to use or service it. Local laws may regulate the age of the user.



WARNING! You must use approved personal protective equipment whenever you use the machine. Personal protective equipment cannot eliminate the risk of injury but it will reduce the degree of injury if an accident does happen. Ask your dealer for help in choosing the right equipment.

- Use hearing protection to minimise the risk of hearing impairment.



- Never wear loose-fitting clothing, jewellery or similar that can get caught in moving parts.
- Never use the machine when barefoot. Always wear protective shoes or protective boots, preferably with steel toes.



- Make sure that you have first aid equipment close at hand when using the machine.



Driving on slopes

Driving on slopes is one of the operations where the risk of the driver losing control of the machine or of it overturning is the greatest; this can result in serious injury or death. All slopes demand extra care. If you cannot reverse up a slope or if you feel unsure, do not mow it.

IMPORTANT INFORMATION

Do not drive down slopes with the cutting deck raised.

This is what you do

- Remove obstacles such as stones, branches, etc.
- Mow upwards and downwards, not sideways.

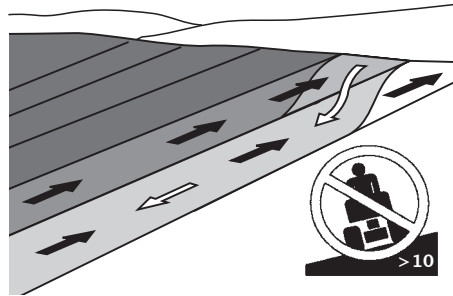

- Do not use the machine on ground that slopes more than 10°.
- Take extra care if any attachments are fitted that can change the stability of the machine.
- Avoid starting or stopping on a slope. If the tyres start to slip, stop the blades and drive slowly down the slope.
- Always drive smoothly and slowly on slopes.
- Do not make any sudden changes in speed or direction.
- Avoid unnecessary turns on slopes, if necessary, turn slowly and gradually downwards if possible. Drive slowly. Do not turn the wheel sharply.
- Watch out for and avoid driving over furrows, holes and bumps. It is easier for the machine to overturn on uneven ground. Tall grass can hide obstacles.

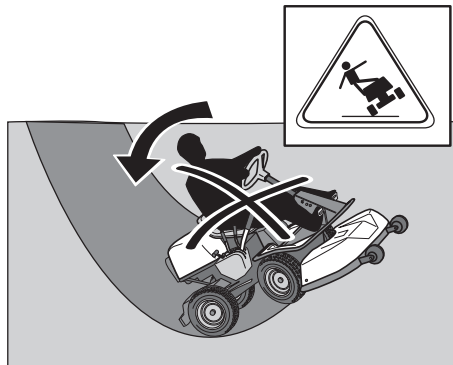

- Do not mow too close to edges, ditches or banks. The machine can suddenly overturn if one wheel comes over the edge of a steep slope or a ditch, or if an edge gives way.
- Do not mow wet grass. It is slippery, and tyres can lose their grip so that the machine skids.
- Do not try to stabilize the machine by putting your foot on the ground.
- When cleaning the chassis, the machine may never be driven near verges or ditches.
- When mowing, keep away from bushes and other objects.

SAFETY INSTRUCTIONS

- Follow the manufacturer's recommendations regarding wheel weights or counterbalance weights to increase machine stability.

IMPORTANT INFORMATION

Wheel weights fitted on the rear wheels are recommended when driving on slopes for safer steering and improved manoeuvrability. Consult your dealer concerning the use of wheel weights if you are unsure. Wheel weights can not be used on AWD-machines. Use counterweights.

Children

- Serious accidents may occur if you fail to be on your guard for children in the vicinity of the machine. Children are often attracted to the machine and mowing. Never assume that children will remain where you last saw them.
- Keep children away from the area to be mowed and under close supervision by another adult.
- Keep an eye out and shut off the machine if children enter the work area.
- Before and during reversing procedures, look behind you and down for small children.
- Never allow children to ride along. They can fall off and seriously injure themselves or be in the way for safe maneuvering of the machine.
- Never allow children to operate the machine.

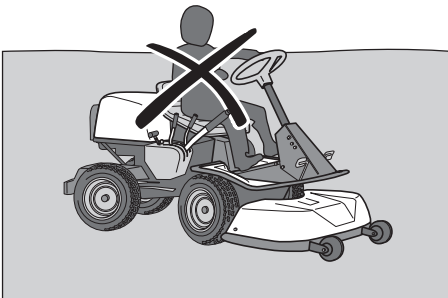

- Be particularly careful near corners, bushes, trees or other objects that block your view.

Maintenance

- Stop the engine. Prevent starting by removing the ignition cable from the spark plug or remove the ignition key before making any adjustments or carrying out maintenance.
- Never fill the fuel tank indoors.



- Petrol and petrol fumes are poisonous and extremely flammable. Be especially careful when handling petrol, as carelessness can result in personal injury or fire.
- Only store fuel in containers approved for the purpose.
- Never remove the fuel cap and fill the fuel tank when the engine is running.
- Allow the engine to cool before refuelling. Do not smoke. Do not fill with fuel in the vicinity of sparks or naked flames.
- Handle oil, oil filters, fuel and the battery carefully, of environmental considerations. Follow the local recycling requirements.
- Electrical shocks can cause injuries. Do not touch cables when the engine is running. Do not test the ignition system with your fingers.



WARNING! The engine and the exhaust system become very hot during operation. Risk of burn injuries if touched. When mowing, keep away from bushes and other materials in order to avoid a heating effect.

- If leaks arise in the fuel system, the engine must not be started until the problem has been resolved.
- Store the machine and fuel in such a way that there is no risk that leaking fuel or fumes can cause any damage.
- Check the fuel level before each use and leave space for the fuel to expand, because the heat from the engine and the sun may otherwise cause the fuel to expand and overflow.
- Avoid overfilling. If you spill petrol on the machine, wipe up the spill and wait until it has evaporated before starting the engine. If you spill on your clothing, change your clothing.
- Allow the machine to cool before performing any actions in the engine compartment.
- Take care with battery maintenance. Explosive gases form in the battery. Never perform maintenance on the battery while smoking or in the vicinity of open flames or sparks. This can cause the battery to explode and cause serious injuries.

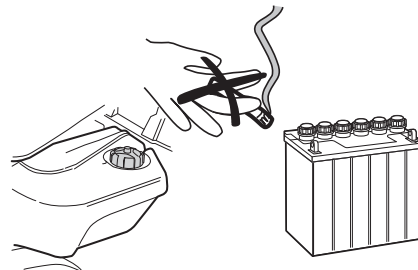

- Make sure all nuts and bolts are tightened correctly and that the equipment is in good condition.
- Do not modify safety equipment. Check regularly to be sure it works properly. The machine must not be driven if protective plates, protective covers, safety switches or other protective devices are not fitted or are defective.
- Observe the risk of injury caused by moving or hot parts if the engine is started with the engine cover open or protective cowlings removed.

SAFETY INSTRUCTIONS

- Do not change the setting of governors. If you run too fast, you risk damaging the machine components. See chapter on Technical data for highest permitted engine speed.
- Never use the machine indoors or in spaces lacking proper ventilation. Exhaust fumes contain carbon monoxide, an odourless, poisonous and highly dangerous gas.

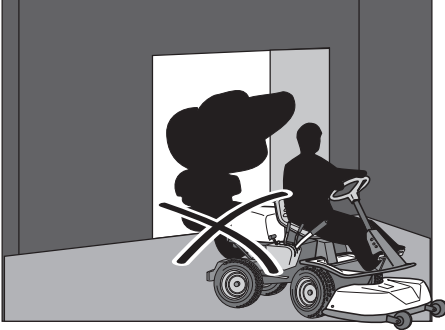

- Stop and inspect the equipment if you run over or into anything. If necessary, make repairs before starting.
- Never make adjustments with the engine running.
- The machine is tested and approved only with the equipment originally provided or recommended by the manufacturer.
- The blades are sharp and can cause cuts. Wrap the blades or wear protective gloves when handling them.
- Check regularly that the parking brake works. Adjust and maintain as required.
- Reduce the risk of fire by removing grass, leaves and other debris that may have fastened on the machine. Allow the machine to cool before putting it in storage.

Transport

IMPORTANT INFORMATION

The parking brake is not sufficient to lock the machine during transport. Ensure you secure the machine firmly to the transporting vehicle.

- The machine is heavy and can cause serious crush injuries. Take extra care when loading it onto or off a vehicle or trailer.
- Use an approved trailer to transport the machine.
- To secure the machine on the trailer, two approved tension belts and four wedge shaped wheel blocks should be used.

Engage the parking brake and tie the tension belts around stable parts on the machine, e.g. frame or rear wagon. Secure the machine by tensioning the belts towards the back and the front of the trailer respectively.

Place the wheel blocks in front of and behind the rear wheels.

- Check and observe local road traffic regulations before transporting or driving the machine on roads.

PRESENTATION

Presentation

Congratulations on your choice of an excellent quality product that will give you great pleasure for many years. This operator's manual describes R 418 Ts and R 418 Ts AWD. The machines are equipped with a four-stroke V-Twin engine from Kawasaki.

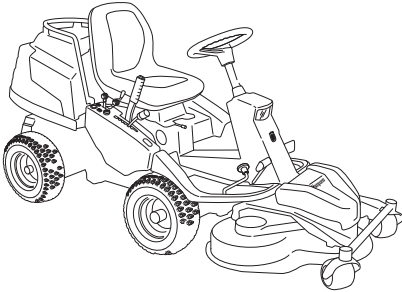

The machines are equipped with power steering and hydraulic lifts. R 418 Ts AWD also have all wheel drive.

The power transmission from the engine is handled by a hydrostatic transmission, which allows variable variation of the speed by using the pedals. One pedal for driving forward and one for reverse.

Throttle trigger

The throttle control regulates the engine speed, and thereby also the rotation speed of the blades.

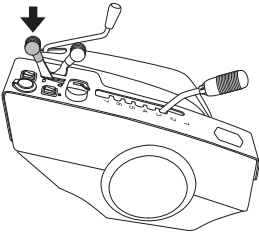

To increase or reduce the engine speed the control is moved forwards or backwards.

Avoid idling the engine for long periods, as there is a risk of carbon build-up on the spark plugs.

Choke control

The choke lever is used for cold starting and to give the engine a richer fuel mixture.

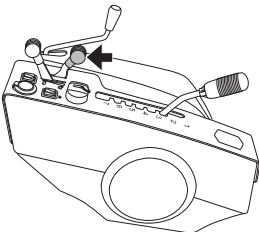

For cold starting the lever is moved backwards to its end position.

Speed limiter

The speed of the machine is steplessly regulated with two pedals. Pedal (1) is used to drive forwards, and pedal (2) to drive backwards.

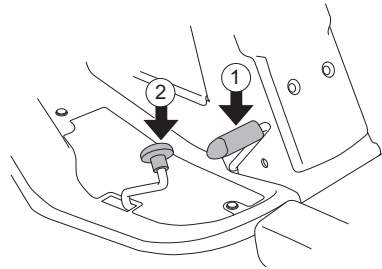

WARNING! Make sure that branches do not obstruct the pedals when mowing under bushes. Otherwise there is a risk you may lose control.

Counter

The chronometer shows how many hours the engine has been running.

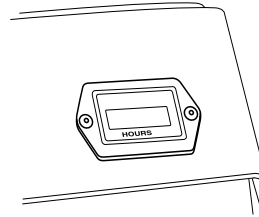

Any time when the engine is not running but the ignition is switched on is not registered. The last digit shows tenths of an hour (6 minutes).

Parking brake

The parking brake is applied as follows:

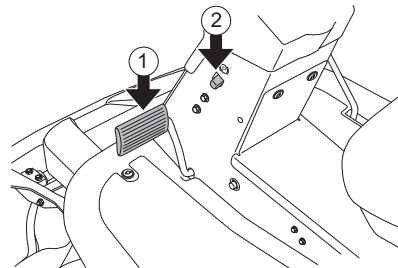

- 1 Press down the parking brake pedal (1).
- 2 Press in the lock button (2) on the steering column.
- 3 Release the parking brake pedal while keeping the button pressed in.

The parking brake lock disengages automatically when the brake pedal is pressed.

PRESENTATION

Cutting unit

R 418 Ts and R 418 Ts AWD can be equipped with three different cutting units. Combi 94, Combi 103, Combi 112

The Combi-unit, equipped with a BioClip-plug, finely chops the cuttings to fertiliser. Without the BioClip-plug the unit works in the same way as a rear ejection unit. The rear ejector ejects the clippings behind the unit without finely chopping them.

Lever for hydraulic lift of attachments

The lifting lever is used to put the cutting unit in either the transport or mowing position when hydraulic pressure is available.

When the lever is moved to the transport position, the blade brake is automatically activated so that the blades stop within about 5 seconds.

Lifting the Cutting Unit (Transport Position)

Pull the lever backwards to engage the transport position. The cutting unit will lift up and the blades stop rotating.

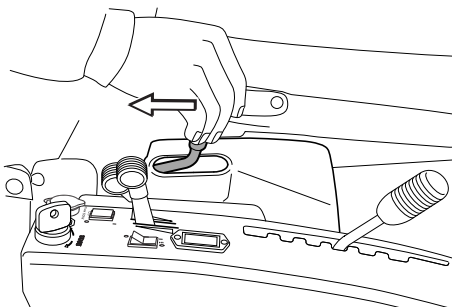

Secure the cutting unit if necessary using the mechanical lifting lever.

Lowering the Unit (Mowing Position)

If the cutting unit is secured in the transport position using the mechanical lifting lever, move the mechanical lifting lever to the cutting position.

Move the hydraulic lifting lever forwards to engage the cutting position. The unit is lowered and the blades begin to rotate.

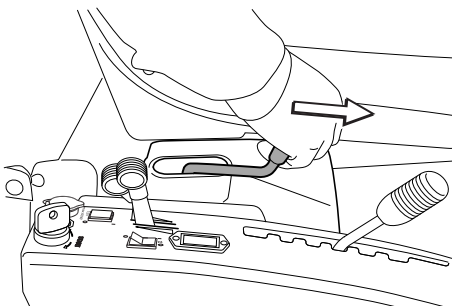

In order to ensure that the hydraulic cylinder is in the outer position, hold the lever in the forward position for a half to one second.

Mechanical Lifting Lever for Cutting Unit

The lever is used as a backup lever to put the cutting unit in either the transport or mowing position when hydraulic pressure is unavailable. It can also be used to mechanically secure the cutting unit in the transport position.

The lever must be used when starting the engine, if the engine stopped with the unit in the mowing position, in order to raise the unit so that the start lock circuit is disengaged.

When the lever is moved to the transport position, the blade brake is automatically activated so that the blades stop within about 5 seconds.

Transport position

If the lever is pulled backwards the unit is raised and the blades automatically stop rotating (transport position).

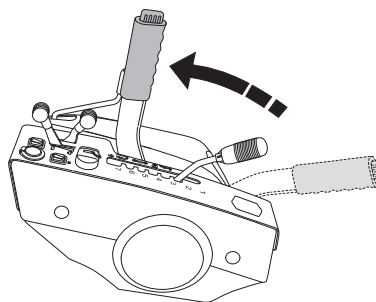

Mowing Position

If the lock button is pressed in and the lever is moved forwards the unit will be lowered and the blades will automatically start to rotate (mowing position).

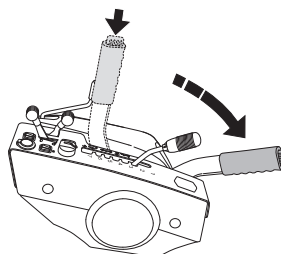

If this does not happen it is probably because the unit has been lifted with the hydraulic lifting lever. Lower the unit to the mowing position with the lever for the hydraulic lift.

Cutting height adjustment lever

The cutting height can be adjusted to 7 different positions with the cutting height lever.

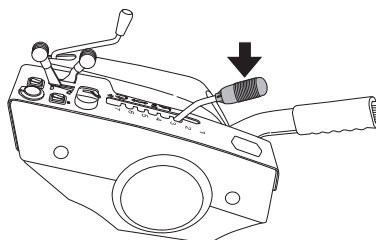

It is important that the air pressure in both front wheels is equal, 60 kPa/8.5 PSI, to produce an even cutting height.

PRESENTATION

Seat

The seat has a jointed attachment on the front edge and can be tipped forward.

The seat can also be adjusted lengthways.

To adjust move the lever under the front edge of the seat to the left, so that the seat can be moved forward or backwards to the required position.

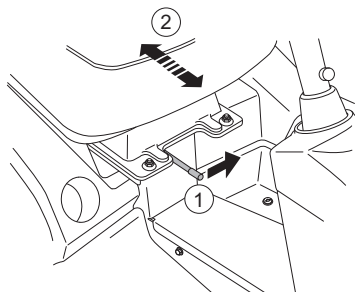

The seat springing can be adjusted by moving the rubber stops in their mountings on the underside of the seat. Place both stops in the front, middle or rear.

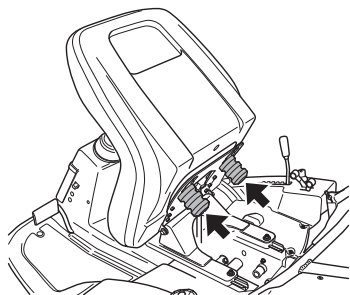

Fueling

The engine runs on unleaded petrol with a minimum octane rating of 87 (not mixed with oil). We recommend the use of biodegradable alkylate petrol. (max. methanol 5%, max. ethanol 10%, max. MTBE 15%)

Do not fill the tank completely, leave an expansion area of at least 2.5 cm (1").

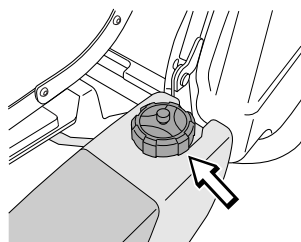

WARNING! Petrol is highly inflammable. Exercise care and refuel outdoors (see safety instructions).

IMPORTANT!

Do not use the fuel tank as a support area.

Lights and power outlet

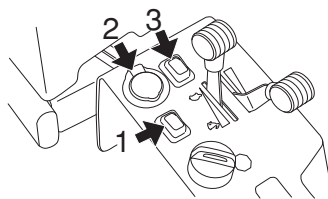

The lights are switched on and off using the power switch (1) on the control panel.

A seat heater or mobile phone charger are examples of articles that can be connected to the power socket (2).

The power outlet is switched on and off using power switch (3) on the control panel.

The voltage is 12 V.

The power outlet is fuse protected by its own fuse, which is located below the ignition switch.

Release lever

The release control must be pulled out in order for the machine to be moved when the engine is shutoff.

Should you attempt to drive the machine with the clutch controls pulled out it will not move. The drive on the axle is disengaged when one of the controls is pulled out.

Pull the controls to the end positions, do not use an intermediate position.

Release lever R 418Ts AWD

R 418 Ts AWD have one control for the front axle and one control for the rear axle.

IMPORTANT! Always drive the machine with both clutch controls pressed in.

- Clutch control, rear axle

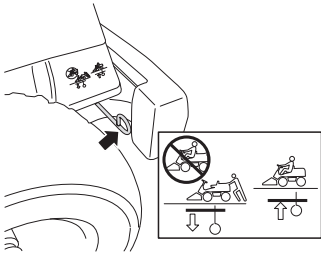

- Control drawn out, drive system disengaged.
- Control depressed, drive system engaged.

- Clutch control, front axle

The control is positioned on the inside of the left front wheel.

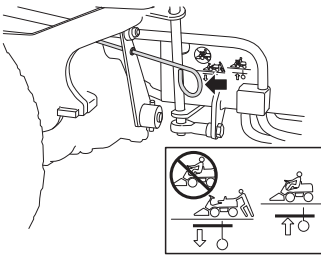

- Rear control (pulled out), drive system disengaged.
- Front control (pushed in), drive system engaged.

Release lever R 418Ts

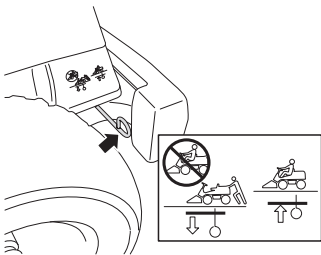

- Pull out the control to disengage the drive system.
- Push in the control to engage to the drive system.

Driving

Cutting tips

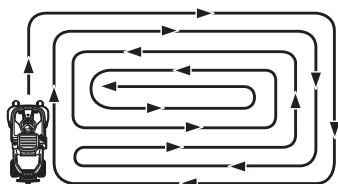

WARNING! Clear the lawn from stones and other objects which can be thrown out by the blades.

- Localise and mark stones and other fixed objects to avoid collision.
- Start with a high cutting height and reduce down until the required mowing results are obtained.
- The mowing result will be best with the highest permitted engine speed, see technical data, (the blades rotate rapidly) and low speed (the Mower moves slowly). If the grass is not too high and thick, the driving speed can be increased without noticeably depreciating the mowing result.
- The best lawns are achieved if the grass is cut often. Mowing becomes more uniform and the grass cuttings become more evenly distributed over the surface. The total time consumption is not greater since it is possible to select a higher driving speed without inferior mowing results.
- Avoid mowing a wet lawn. The mowing results are inferior since the wheels sink down into the soft lawn.
- Hose down the cutting unit with water underneath each time it is used. The cutting unit should then be put in the service position.
- When the BioClip function is used, it is very important that the mowing interval is not too long.



WARNING! Do not use the machine on ground that slopes more than 10°. Mow slopes upwards and downwards, never across. Avoid sudden changes in direction.

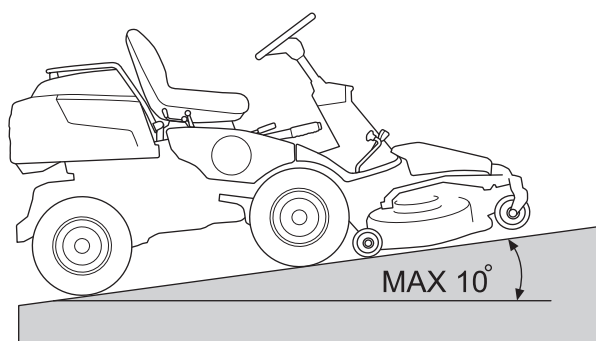

Before starting

- Read the safety instructions and information concerning the placement of controls and functions before starting.
- Perform daily maintenance before starting as set out in the Maintenance schedule.

IMPORTANT INFORMATION

The air intake grille in the engine cover behind the driver's seat must not be blocked by, for example, clothing, leaves, grass or dirt. Impaired cooling of the engine. Risk of major engine damage.

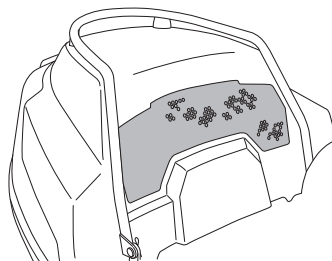

Start the engine

- 1 Make sure that the clutch control is depressed. R 418 Ts AWD have one control for the front axle and one control for the rear axle.

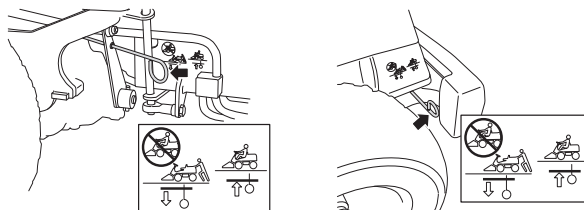

- 2 Lift up the cutting unit by pulling the lever backwards to locked position (transport position) and apply the parking brake.

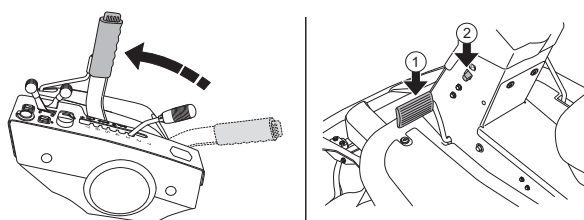

The engine can not be started if the parking brake is not pressed down.

- 3 Move the throttle control to the middle position.

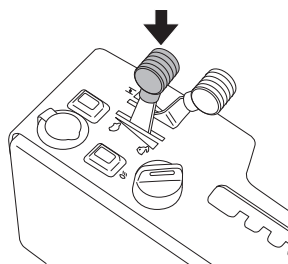

Driving

- 4 If the engine is cold move the choke lever backwards to its end position.

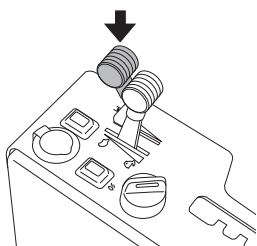

- 5 Turn the ignition key to the start position.

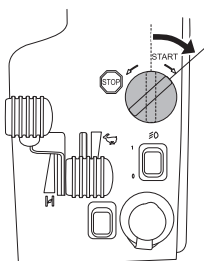

- 6 When the engine starts release the ignition key immediately back to neutral position.

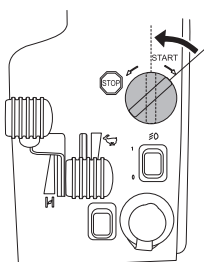

IMPORTANT INFORMATION

Do not run the starter for more than about 5 seconds at a time. If the engine does not start, wait about 15 seconds before trying again.

- 7 Push the choke lever gradually forward when the engine has started.

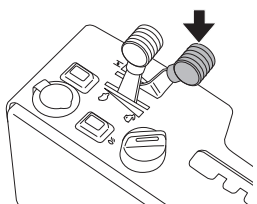

- 8 Let the engine run at moderate speed or half throttle for 3-5 minutes before subjecting it to heavy load.

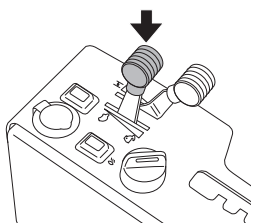

- 9 Set the required engine speed with the throttle control.



WARNING! Never run the engine indoors, in enclosed or poorly ventilated areas. The exhaust fumes contain toxic carbon monoxide.

Starting the engine with a weak battery



WARNING! Lead-acid batteries produce explosive gases. Avoid sparks, open flames and smoking close to batteries. Always wear protective glasses in the vicinity of batteries.

If the battery is too weak to start the engine, it should be recharged.

When jump leads are used for emergency starting, follow the procedure below:

IMPORTANT INFORMATION Your Rider is equipped with a 12-volt system with negative earth. The other vehicle must also have a 12-volt system with negative earth. Do not use your Rider battery to start other vehicles.

Connecting the jump leads

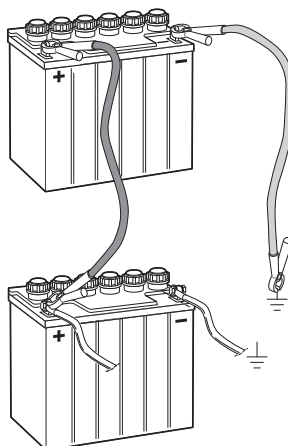

- Connect each end of the red cable to the POSITIVE pole (+) on each battery, exercise care not to short circuit any of the ends against the chassis.
- Connect one end of the black cable to the NEGATIVE pole (-) on the fully charged battery.
- Connect the other end of the black cable to a good CHASSIS EARTH, away from the fuel tank and the battery.

Remove the cables in the reverse order

- The BLACK cable is removed from the chassis and then the fully charged battery.
- Finally the RED cable from both batteries.

IMPORTANT INFORMATION

Never use a boost charger/start booster.

Use only conventional battery chargers. Always disconnect the charger before starting the engine. So called boost chargers/start boosters must never be used. These will often increase the voltage (instead of the current) to generate the power needed to start the engine. This increase in voltage will damage the electrical system.

Driving

Driving the Rider

- 1 Release the parking brake by first pressing down the parking brake pedal and then releasing it.

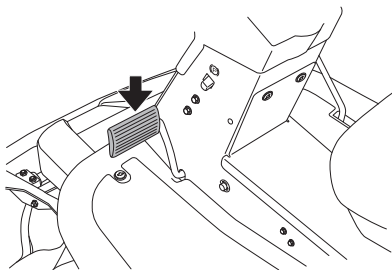

- 2 Carefully press down one of the pedals until the required speed is obtained. Pedal (1) is used to drive forwards, and pedal (2) to drive backwards.

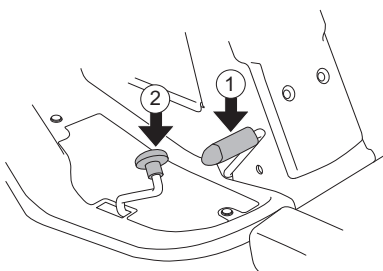

- 3 Press in the lock button on the mechanical lifting lever and lower the cutting unit.

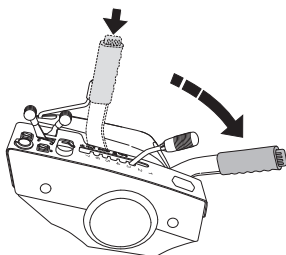

If the cutting unit does not lower completely, or if the blades do not rotate, lower the cutting unit completely using the hydraulic lifting lever. In order to ensure that the hydraulic cylinder is in the outer position, hold the lever in the forward position for a half to one second.

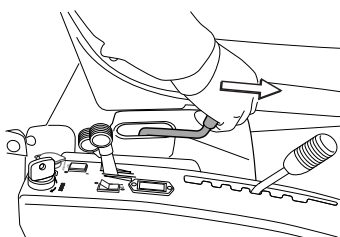

- 4 Select the required cutting height (1-10) with the cutting height lever.

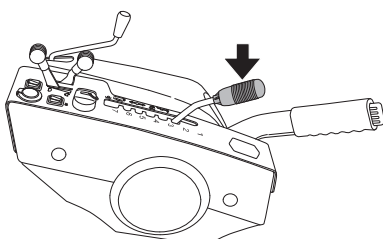

It is important that the air pressure in both front wheels is equal, 60 kPa / 0,6 bar / 8.7 PSI, to produce an even cutting height.

IMPORTANT INFORMATION

The life span of the drive belts is increased significantly if the engine runs at a low speed when the blades are engaged. Therefore apply full throttle first when the cutting unit has been moved to the mowing position.

Driving

Braking

Release the drive pedals. The machine slows and is stopped by the drive system. Do not use the parking brake as the drive brake.

Quicker braking is possible if you press down the drive pedal for the opposite direction.

Stop the engine

Preferably allow the engine to idle for a minute to obtain normal working temperature before stopping it if it has been working hard. Avoid idling the engine for long periods, as there is a risk of carbon build-up on the spark plugs.

- 1 Lift the cutting unit with the hydraulic lifting lever.

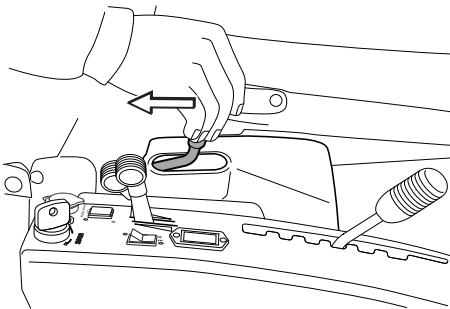

The unit can then be secured in the raised position if necessary by moving the mechanical lifting lever backwards to the lock position.

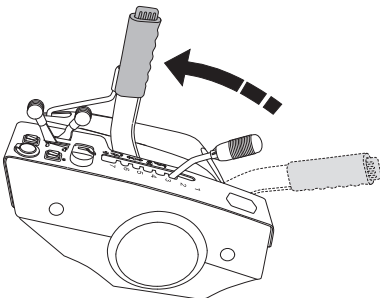

If the cutting unit is left in the lower position, the start lock circuit will prevent engine starts.

- 2 Move the throttle control to the MIN. position. Turn the ignition key to the "STOP".

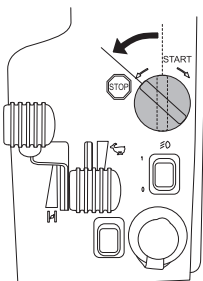

- 3 When the Rider is at a standstill, press down the parking brake and push in the locking button.

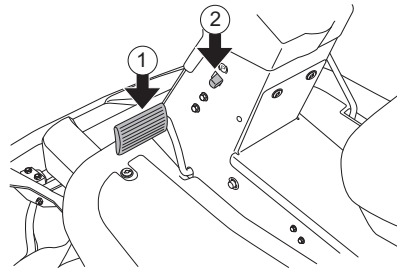

Maintenance

Maintenance schedule

The following is a list of the maintenance which should be conducted on the machine. For those points not described in this manual, visit an authorised service workshop.

Maintenance	Daily maintenance before starting	Weekly maintenance ³⁾	At least once a year	Maintenance interval in hours			
				25	50	100	250
Cleaning	X						
Check the engine's oil level	X						
Check the engine's cooling air intake	X						
Check the fuel pump air filter	X						
Check the steering wires	X						
Check the level of the battery acid	X						
Check the safety system	X						
Check nuts and screws	O						
Check for fuel and oil leakage.	O						
Clean around the silencer	O						
Start engine and blades, listen for noise	O						
Clean transmission air intake	X			X			
Change engine oil ¹⁾			X		X ¹⁾	X ¹⁾	
Check the cutting deck	X			X			
Checking the blades	X						
Clean underside of cutting unit	X						
Check the air pressure in the tyres, 60 kPa/8.5 PSI.				X			
Lubricate belt tensioner (nipple)		X		X			
Lubricate the driver's seat		X					
Lubricate all wires		X					
Lubricate bearing surfaces on cutting unit		X					
Clean inside frame tunnel		X					
Lubricate the pedal system in the frame tunnel		X					
Lubricate the hydrostatic cable with links		X					
Check the parking brake	X						
Lubricate the parking brake wire		X					
Lubricate throttle control		X					
Lubricate choke control		X					
Lubricate the chain in the frame tunnel		X					
Check steering chain inside frame tunnel		X					
Check for damage to wire guide at articulated joint		O					
Clean thoroughly around engine		X					
Clean thoroughly around transmission		X					
Check the V-belts					O		
Check the cooling fins on the hydrostatic transmission			X			X	
Checking the transmission oil level		X					

Maintenance

Maintenance	Daily maintenance before starting	Weekly maintenance ³⁾	At least once a year	Maintenance interval in hours			
				25	50	100	250
Checking and adjusting the choke wire					X		
Tighten the nuts and screws						O	
Checking and adjusting of throttle wire					X		
Clean the air filter.			X	X			
Check/adjust cutting height setting			X		X		
Check/adjust parking brake			X		X		
Clean the cooling fins on the engine and hydrostatic transmission ²⁾					O		
Replace the air filter.							X
Replace the fuel filter						X	
Replace the spark plug.						X	
Check to see whether the oil ^{4,5)} or the filter ^{4,5)} needs changing in the gear box			O				
Replace the engine oil filter			X			X	
Replace the suction filter in the hydraulic tank ⁴⁾			O				
Check the synchronisation between the front and rear wheels.			O	O			
Carry out 300 hour service ⁴⁾							O

¹⁾First change after 8 hours. When operating with a heavy load or at high ambient temperatures, replace every 50 hours. ²⁾Maintenance and replacement are required more often in dusty conditions. ³⁾If the machine is used daily it should be lubricated twice a week. ⁴⁾Conducted by authorised service workshop. ⁵⁾Only R 418Ts AWD first change after 8 hours

X = Described in this operator's manual

O = Not described in this operator's manual



WARNING! No service procedures must be conducted on the engine or cutting unit unless:

- The engine is switched off.**
- The parking brake is applied.**
- The ignition key is removed.**
- The cutting unit is disengaged.**
- The ignition cables are removed from the plugs.**

Maintenance

Cleaning

Clean the machine directly after use. It is much easier to wash off grass cuttings before they dry.



Oily dirt can be removed using a cold degreasing agent. Spray on a thin layer.

Rinse at normal water pressure.

Do not direct the jet towards electrical components or bearings.

Do not rinse hot surfaces such as the engine and exhaust system.

It is recommended that you start the engine and run the mower for a short period after cleaning, so that any remaining water is blown off.

Lubricate the machine if necessary after cleaning. Carry out extra lubrication when the bearings have been exposed to a degreaser or a water jet.

IMPORTANT INFORMATION

Avoid using a high pressure washer or a steam cleaner.

There is a major risk of water penetrating into bearings and electrical connections. Corrosion attack can result, which will lead to running problems. Cleaning additives generally aggravate the damage.

Removing of the machine hoods

Engine cover

Pull the seat forward to its foremost position. Fold up the seat.

Pull the snap catches on the engine cover backwards. The snap catches are located on the inside of the engine frame.

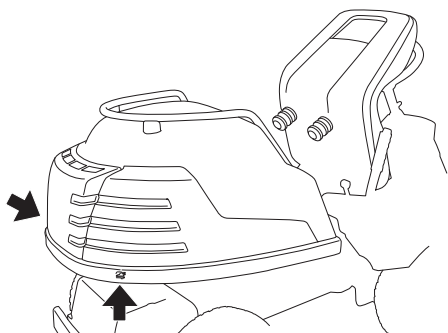

Open the engine cover forwards.

Front cover

Release the clip on the front hood and lift off the fender.

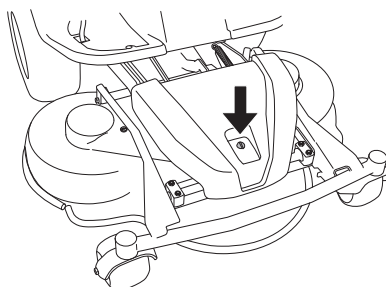

The front cover is secured to the unit frame with two hooks.

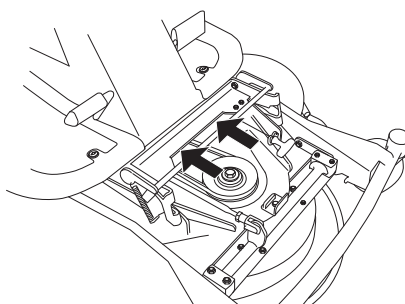

Right-hand fender

Remove the accelerator knob (1), screws (2 and 3), and remove the cover.

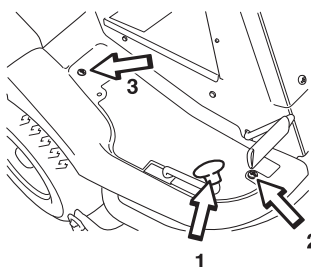

Left-hand fender

Remove the screws holding the wing cover (2) and lift off the cover.

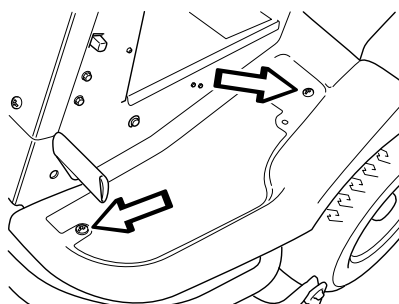

Transmission cover

Undo the two screws (one on each side) and lift off the transmission cover.

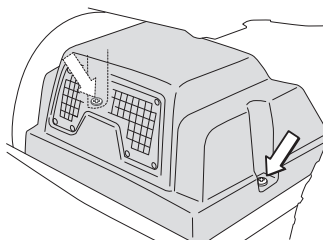

Maintenance

Checking and adjusting the steering wires

The steering is controlled by means of wires.

These can in time become slack, which implies that the adjustment of the steering becomes altered.

Check and adjust the steering as follows:

- 1 Remove the frame plate by loosening the screws (2) and lift the frame plate by the rear edge.

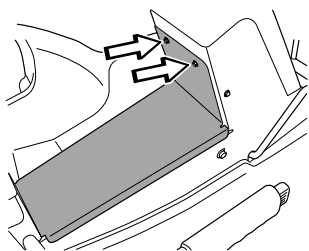

- 2 Check the tension of the steering wires by squeezing them together by the arrows as illustrated. It should be possible to push them together so that the distance between them is half as much, without using unnecessary force.

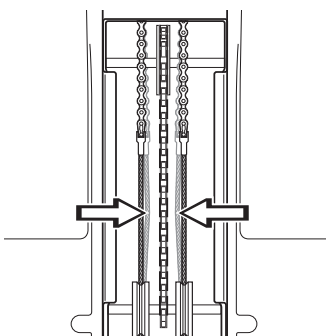

- 3 If necessary, the wires can be adjusted by tightening the adjuster nuts on each side of the steering collar. Do not over tighten the cables; they should only be drawn in towards the steering collar.

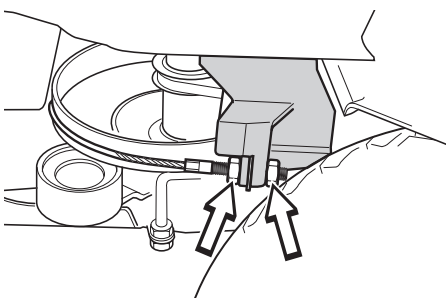

Hold the cable, for example using an adjustable wrench, so that it does not twist.

If the adjustment is only made on one side, the middle position of the steering will be affected.

Check the wire tension on completion of the adjustment as per item 2.

Adjusting the parking brake R 418Ts

Check that the parking brake is adjusted correctly by placing the machine on a slope with the front and rear axles disengaged.

Apply and lock the parking brake.

When the machine does not stand still, the parking brake should be adjusted according to the following.

- 1 Position the machine on flat ground.
- 2 Remove the transmission cover.
- 3 Unhook the spring (A) from the screw (B).

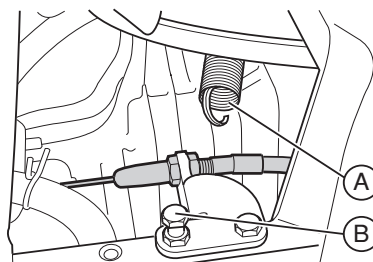

- 4 Make sure the parking brake is released.
- 5 Adjust so there is 1 mm play between the outer cable and the adjuster screw when you pull the outer cable.

Adjust the adjuster screw using the nuts.

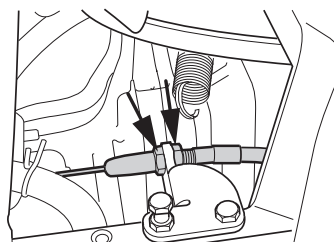

- 6 Tighten the nuts carefully to prevent damaging the adjuster screw.
- 7 Refit the spring (A).
- 8 The parking brake should be checked again after the adjustment has been made.



WARNING! A poorly adjusted parking brake can result in reduced braking ability.

Adjusting the parking brake R 418Ts AWD

Check that the parking brake is adjusted correctly by placing the machine on a slope with the front and rear axles disengaged.

Apply and lock the parking brake. When the machine does not stand still, the parking brake should be adjusted according to the following.

- 1 Position the machine on flat ground.
- 2 Make sure the parking brake is released.

Maintenance

- 3 Remove the left-hand wing cover.

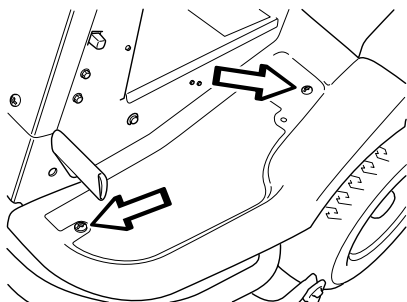

- 4 Loosen the locking nuts.
- 5 Adjust the play between the casing and the adjustment screw to 1 mm (0.040") when one pulls the casing. This gives a play on the pedal of approximately 40 mm.

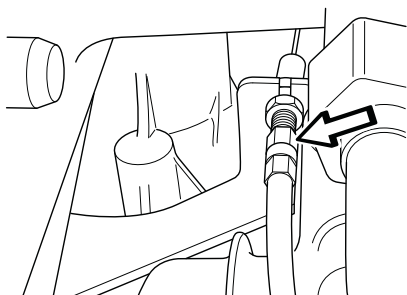

- 6 Tighten the nuts carefully to prevent damaging the adjuster screw.
- 7 The brake should be checked again after adjustment
- 8 Assemble the left-hand wing cover.



WARNING! A poorly adjusted parking brake can result in reduced braking ability.

Checking and adjusting of throttle wire

Check that the engine responds to the throttle control and that the correct engine speed is achieved at full throttle.

If doubts arise, contact your service representative.

If adjustment is necessary, adjust the lower wire as follows:

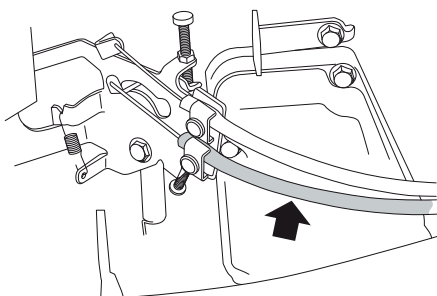

- 1 Loosen the clamping screw for the cable's outer casing and move the throttle to the full throttle position.
- 2 Check that the throttle wire is attached to the correct hole in the lower lever, see diagram.
- 3 Pull the throttle wire casing to the far left and tighten the clamping screw.

Checking and adjusting the choke wire

If the engine is producing black smoke or is difficult to start then the choke wire (upper wire) may be incorrectly adjusted.

If doubts arise, contact your service representative.

If it is necessary to adjust the choke, proceed as follows:

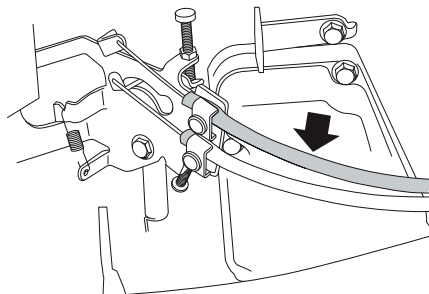

- 1 Release the clamping screw that secures the wire casing and set the choke control to maximum choke.
- 2 Check that the throttle wire is attached to the upper lever, see diagram.
- 3 Pull the choke wire casing to the far right and tighten the clamping screw.

Replacement of fuel filter

Replace the fuel filter every 100 running hours (once per season) or more frequently if it is clogged.

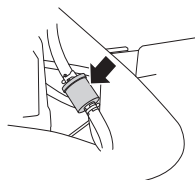

Replace the filter as follows:

- 1 Open the engine cover.
- 2 Move the hose clips away from the filter. Use a pair of flat pliers.
- 3 Pull off the filter from the hose ends.
- 4 Press the new filter into the ends of the hoses. If necessary apply liquid detergent to the ends of the filter to facilitate connection.
- 5 Push the hose clips back on the filter and tighten.

Checking the fuel pump's air filter

Check regularly that the fuel pump's air filter is free from dirt.

The filter can when necessary be cleaned with a brush.

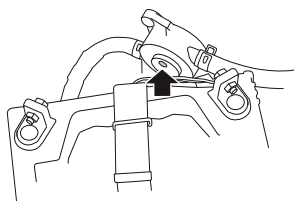

Maintenance

Checking the transmission's air intake

Check that the transmission's air intake is not blocked.

Remove the transmission cover and clean any grass cuttings from the transmission's cooling fins if necessary.

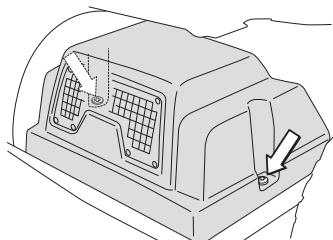

Cooling is impaired if the air intakes are blocked or the transmission housing is dirty, this can result in damage to the transmission.

Replacing the air filter



WARNING! The exhaust system is hot. Let it cool before starting to replace the air filter.

If the engine seems to lack power or does not run smoothly this may be because the air filter is clogged. It is therefore important to replace the air filter at regular intervals (see Maintenance/Maintenance Schedule for the correct service interval).

Replace the air filter as follows:

- 1 Open the engine cover.
- 2 Loosen the knobs holding the filter cover in place and remove it.

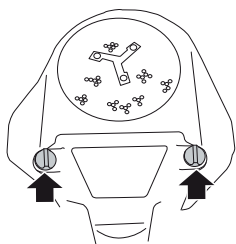

IMPORTANT INFORMATION

Never run the engine without the air filter fitted.

The filters must not be oiled. They must be fitted dry.

- 3 Pull up the filter at one edge and lift it out.

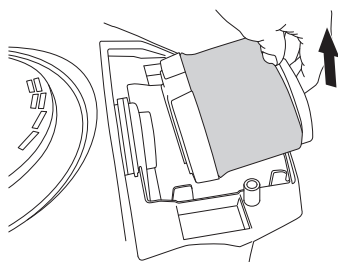

- 4 Remove the foam rubber prefilter which is placed around the filter cartridge and clean using a mild detergent. Squeeze it dry in a clean cloth.

Clean the filter by knocking it with care against a hard surface. Do not use compressed air to clean the filter. Replace the air filter if it is still dirty. If the paper filter is still dirty it should be replaced with a new one.

- 5 Refit the pre-filter on the paper filter.
- 6 Put the filter cartridge back in place. Make sure the filter cartridge is correctly fitted in the filter housing.

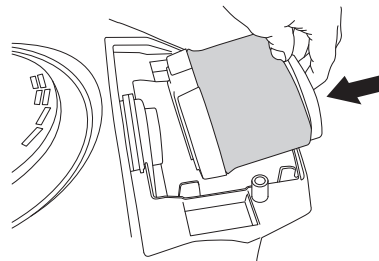

- 7 Refit the air filter cover.

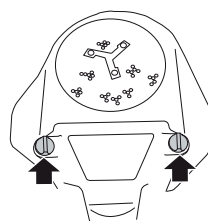

Ignition system

The engine is equipped with an electronic ignition system. Only the spark plug requires maintenance.

For recommended spark plug, see Technical data.

IMPORTANT INFORMATION

Fitting the wrong spark plug type can damage the engine.

Replacing the spark plug

- 1 Remove the ignition cable shoe and clean around the spark plug.
- 2 Remove the spark plug with a 3/4" (19 mm) spark plug socket wrench.
- 3 Check the spark plug. Replace the spark plug if the electrodes are burned or if the insulation is cracked or damaged. Clean the spark plug with a steel brush if it is to be reused.
- 4 Measure the electrode gap with a gapping tool. The gap should be 0.75 mm/0.030". Adjust as necessary by bending the side electrode.
- 5 Reinsert the spark plug, turning by hand to avoid damaging the threads.
- 6 Tighten the spark plug, once it touches the seating, with the spark plug spanner. Tighten the spark plug so that the washer is compressed. A used spark plug should be turned 1/8 of a turn from the seated position. A new spark plug should be turned a 1/4 turn from the seated position.
- 7 Replace the ignition cable shoe.

IMPORTANT INFORMATION

Inadequately tightened spark plugs can cause overheating and damage the engine. Tightening the spark plug too much can damage the threads in the cylinder head.

Maintenance

Cleaning the engine and muffler

Keep the engine and muffler free from grass cuttings and dirt. Grass cuttings steeped in petrol or oil on the engine can increase the fire risk and impair cooling.

Allow the engine to cool before cleaning. If the dirt is mixed with oil, remove it using a degreasing agent otherwise just water and a brush.

Grass cuttings around the muffler dry quickly and constitute a fire risk. Brush or wash them off when the muffler is cold.

Check the safety system

The machine is equipped with a safety system that prevents starting or driving under the following conditions.

The engine must only be possible to start when the following conditions are met:

- The cutting unit is in raised position.
- The parking brake is applied.

The engine must stop under any of the following conditions:

- The cutting deck is lowered and the driver rises from the seat.
- The cutting deck is in its raised position, the parking brake is not applied and the driver rises from the seat.

Check daily to ensure that the safety system works by attempting to start the engine when one of the conditions above is not met. Change the conditions and try again.

Replacing the light bulbs

For information about the bulb type, see Technical Data.

- 1 Unscrew the two screws holding the cover on the power servo housing.

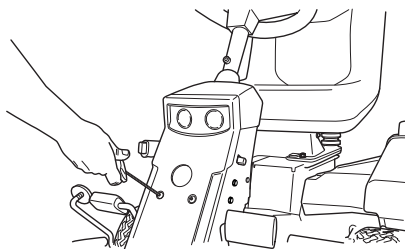

- 2 Lift up the cover and turn it around the steering shaft.
- 3 Unscrew the two screws holding the lamp insert.

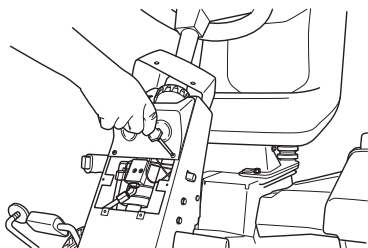

- 4 Lift out the lamp insert.

- 5 Disconnect the cables from the bulbs.

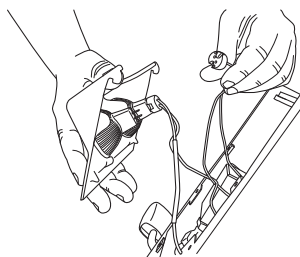

- 6 Lift out the bulbs from the insert.
- 7 Insert the new bulbs. Make sure you use your thumb to support the front.

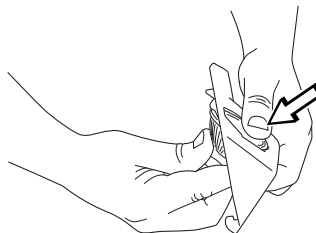

- 8 Refit the cables, lamp insert and the cover on the power servo housing.

Main fuse

The main fuse is placed in a detachable holder under the battery case's cover, in front of the battery. Type: Flat pin, 15 A.

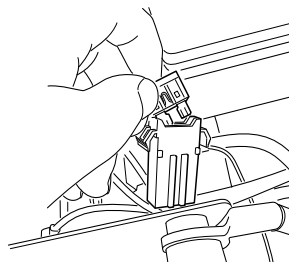

The fuse for the power outlet is placed under the ignition switch, behind the side plate on the control panel. Type: Flat pin, 7,5 A.

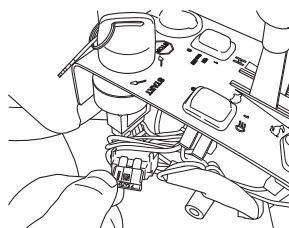

Do not use any other type of fuse when replacing.

A blown fuse is indicated by a burnt connector. Pull the fuse from the holder when replacing.

The fuse is there to protect the electrical system. If it blows again shortly after replacement, it is due to a short circuit, which must be fixed before the machine can be put into operation again.

Maintenance

Checking the tyre pressure

The tyre pressure should be 60 kPa (0.6 bar / 9 PSI) all round. To improve driving the pressure on the rear tyres can be reduced to 40 kPa (0.4 bar/5.6 PSI). The maximum tyre pressure is 100 kPa (1,0 bar/14 PSI).

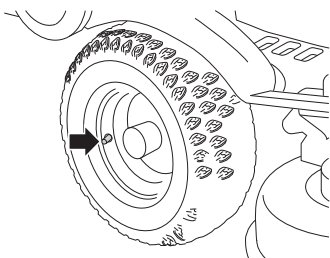

IMPORTANT INFORMATION

Different tyre pressures on the front tyres will result in the blades cutting the grass at different heights.

Checking the engine's cooling air intake

Clean the air intake grille in the engine cover behind the driver's seat.

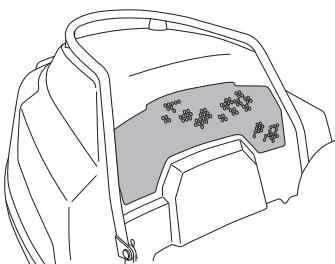

Open the engine cover.

Check that the cooling intake is free from leaves, grass and dirt.

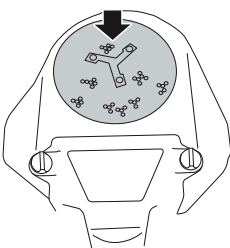

A blocked cooling intake will interfere with the cooling of the engine, which can damage the engine.



WARNING! The cooling air intake rotates when the engine is running. Mind your fingers.

Replacing the rear drive belt R 418Ts

Removal

- 1 Lift up the cutting unit
- 2 Remove the transmission cover.

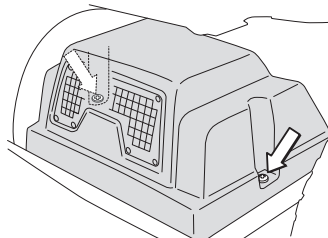

- 3 Unhook the spring (A) from the screw (B).

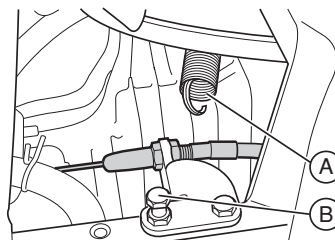

- 4 Remove the hose holder in the middle and the belt guide for the centre belt.

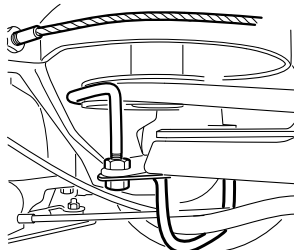

- 5 Pull off the centre belt from the engine's pulley and pull out the rear section.

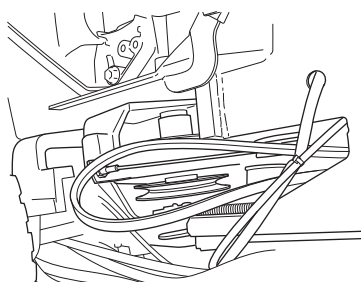

- 6 Remove the cooling fan, it is held in place by a nut.

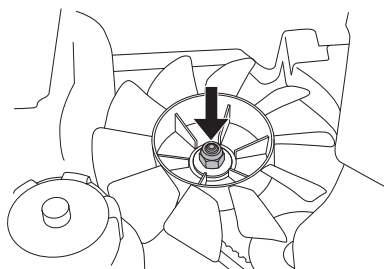

- 7 Remove the belt from the hydrostatic transmission pulley.

Maintenance

- 8 Pull the belt off of the engine's pulley and move it under the engine belt pulleys.

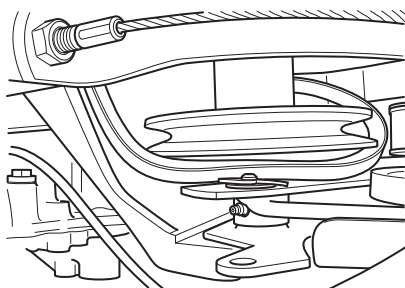

- 9 Pull out the belt through the opening under the pivot bearing and past the belt tensioner's disc.

Assembly

- 1 Pull the belt through the opening under the pivot bearing and on the outside past the belt tensioner's disc.
- 2 Pull the belt under the engine belt pulleys and fit it on the engine belt pulley.

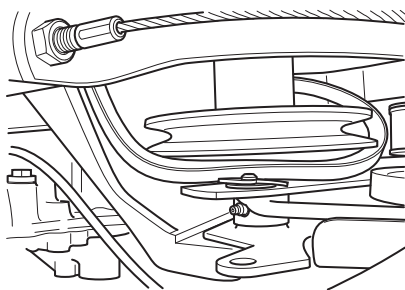

- 3 Fit the belt on the hydrostatic transmission pulley.
- 4 Fit the cooling fan.

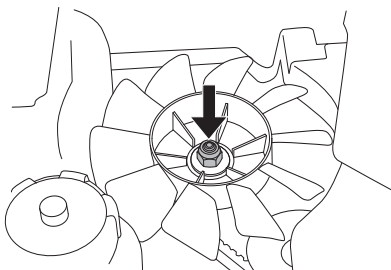

- 5 Check that the centre belt is fitted correctly on its front pulley and fit the centre belt on the engine's pulley.

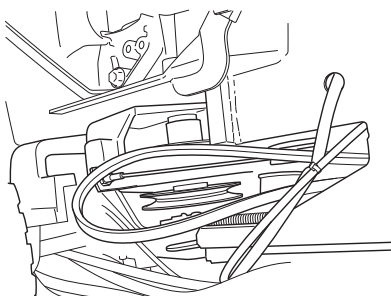

- 6 Fit the hose holder in the middle and the belt guide for the centre belt.

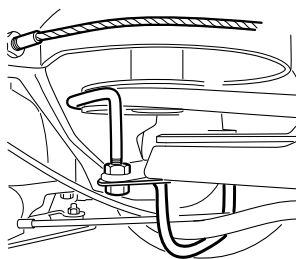

Refit the spring (A).

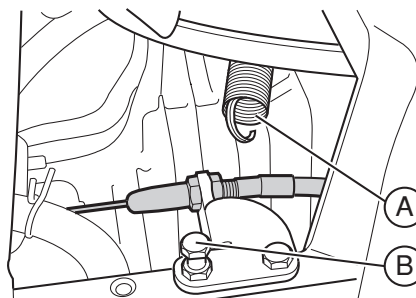

Replacing the hydraulic pump's drive belt R 418Ts AWD

- 1 Remove the transmission cover.
- 2 Unhook the spring on the belt tensioner

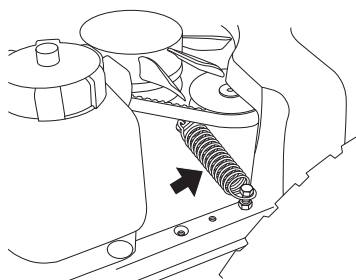

- 3 Remove the belt guide for the centre belt.

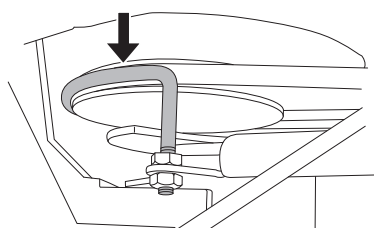

- 4 Pull off the centre belt from the engine's pulley and pull out the rear section.

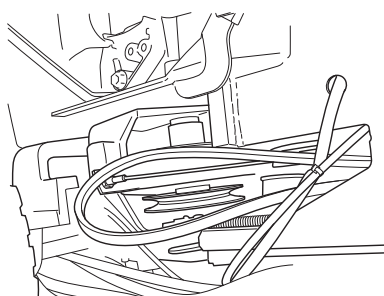

Maintenance

- 5 Remove the cooling fan, it is held in place by a nut.

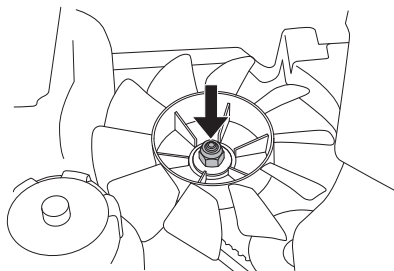

- 6 Pull the belt off of the pump's pulley.
7 Pull the belt off of the engine's pulley and move it under the engine belt pulleys.

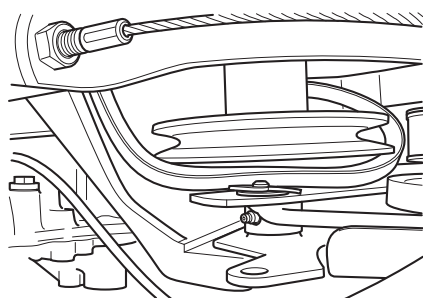

- 8 Pull out the belt through the opening under the pivot bearing and past the belt tensioner's disc.

Assembly

- 1 Pull the belt through the opening under the pivot bearing and on the outside past the belt tensioner's disc.
2 Pull the belt under the engine belt pulleys and fit it on the engine belt pulley.

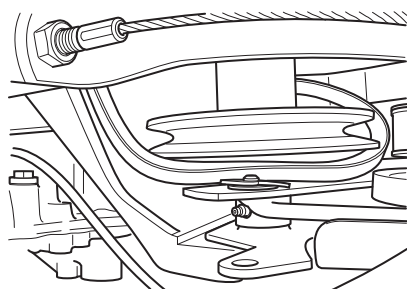

- 3 Fit the belt on the pump's pulley.
4 Fit the cooling fan.

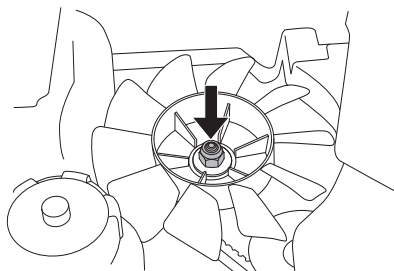

- 5 Check that the centre belt is fitted correctly on its front pulley and fit the centre belt on the engine's pulley.

- 6 Fit the belt guide for the centre belt.

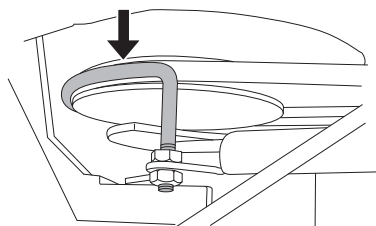

- 7 Fit the spring on the belt tensioner.

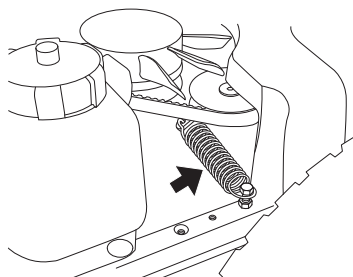

Replacing the centre belt

Remove the belt guide for the centre belt.

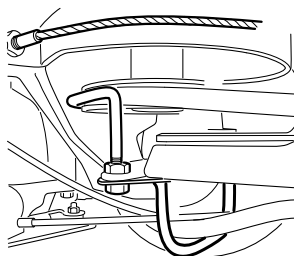

Remove the centre belt and mount a new belt.

Fit and adjust the belt guide with the lower belt on the engine belt pulley.

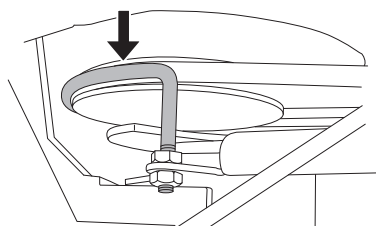

Check and adjust the belt tensioner. This is especially important when fitting a new belt.

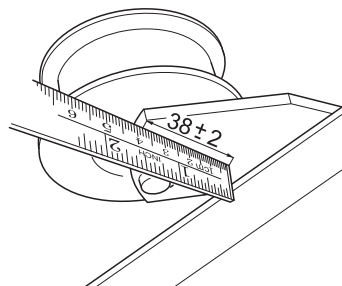

Maintenance

Replacing the front belt

The entire belt is removed according to the following when a snow blade is to be attached to the machine.

- 1 Put the unit in the service position, see Service position for the cutting unit.

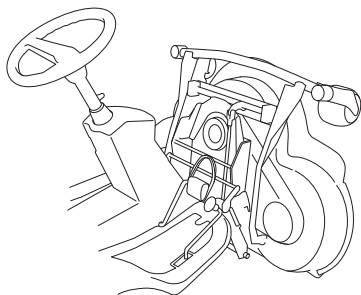

- 2 Pull the centre belt off of the centre pulley. The belt becomes slack when the cutting unit is lifted.
- 3 Take off the front belt from the centre pulley and remove the belt.

Assembly

- 1 Fit the front belt on the centre pulley. Pull it on the outside of the runner wheel and on the inside of the idler pulley.

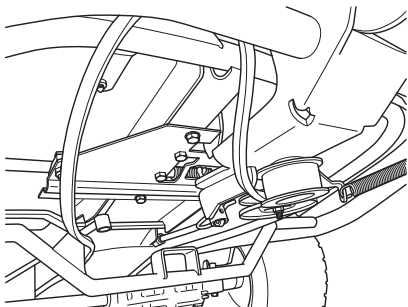

- 2 Fit the centre belt on the centre pulley.

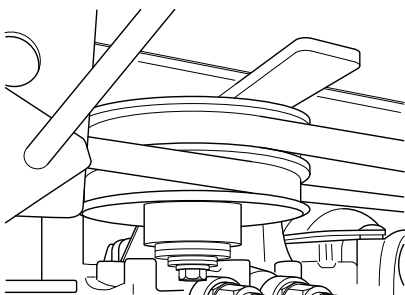

- 3 Reset the cutting unit from service position to mowing position.

Fitting the cutting head



WARNING! Wear protective glasses when fitting the cutting unit. The spring which tensions up the belt may break and cause personal injury.

- 1 Place the machine on a flat surface and apply the parking brake. Check that the lever for setting the cutting height is in the lowest position.

- 2 Push the equipment frame down and place the catch against the frame.

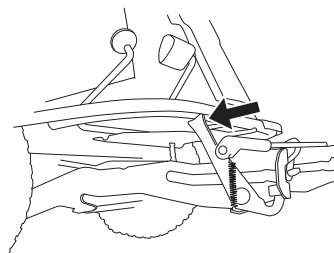

- 3 Remove the drive belt and place it in the belt holder.

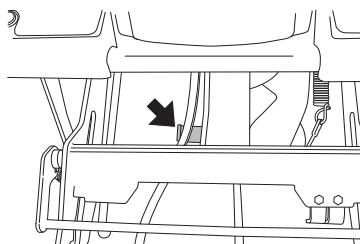

- 4 Push the deck in and put the front guide plugs in the grooves on the equipment frame, one on each side.

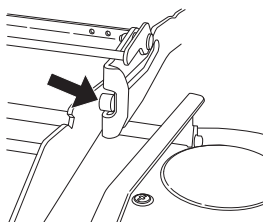

WARNING! Observe caution to avoid trapping your hand.

- 5 Push the unit in so that the interior plugs touch the bottom of the equipment frame's grooves.

- 6 Lift up the cutting unit

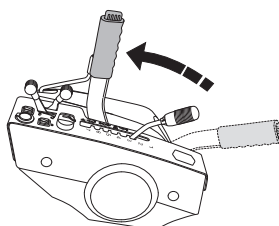

- 7 Fit the drive belt around the drive wheels of the cutting unit. Hook up the height adjustment strut.

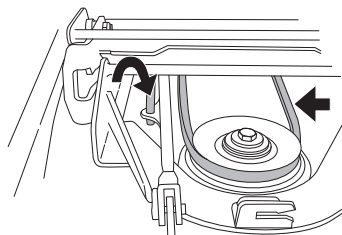

Maintenance

- Secure the collet spring.

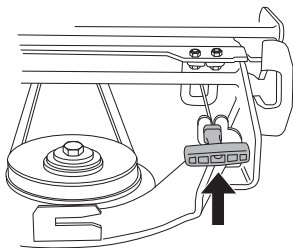

Fit the front cover.

Removing the cutting unit



WARNING! Wear protective glasses when dismantling the cutting unit. The spring which tensions up the belt may break and cause personal injury.

- Carry out points 1-6 to put the cutting unit in the service position, see Service position for the cutting unit.
- Lower the cutting unit.

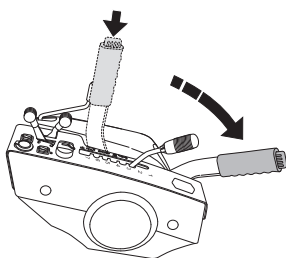

- Open the unit catch.

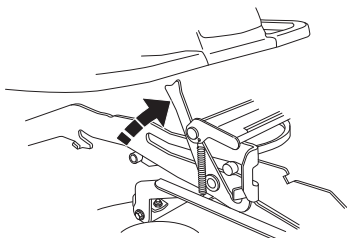

- Pull out the cutting unit.

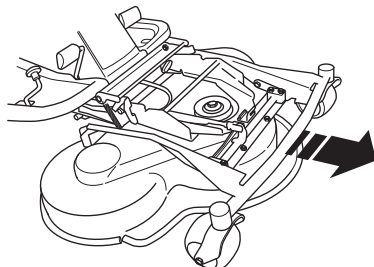

WARNING! Observe caution to avoid trapping your hand.

Checking and adjustment of the cutting unit's ground pressure

To achieve the best cutting results the cutting unit should follow the underlying surface without pressing too hard against it.

Pressure is adjusted using a screw and spring on each side of the Rider.

- Check the air pressure in the tyres 60 kPa / 0.6 bar / 9 PSI.
- Place the machine on a flat surface.
- Put the lifting lever in the mowing position.
- Place a set of bathroom scales under the cutting unit's frame (front edge) so that it rests on the scales. If necessary a block can be placed between the frame and scales so that the support wheels do not bear any weight.

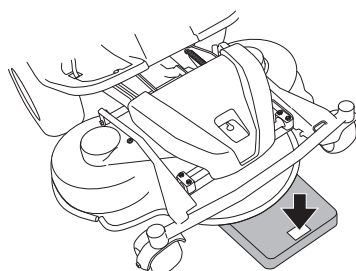

- Adjust the unit's ground pressure by screwing in or out the adjusting screws located behind the front wheels on both sides. The ground pressure should be between 12 and 15 kg (26.5-33 lb).

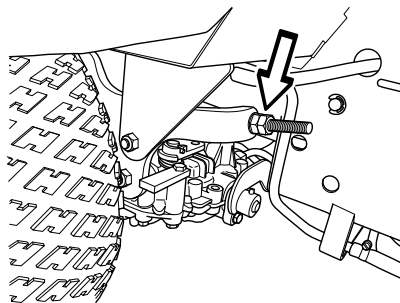

Checking the cutting unit's parallelism

Check the cutting unit's parallelism as follows:

- Check the air pressure in the tyres 60 kPa / 0.6 bar / 9 PSI.
- Place the machine on a flat surface.
- Put the lifting lever in the mowing position.
- Measure the distance between the ground and the front and rear edges of the cutting unit hood. The cutting unit should have a slight slant, with the rear edge 2-4 mm (1/8") higher than the front edge.

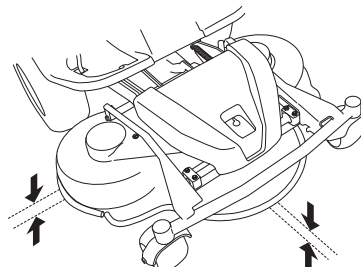

Maintenance

Adjusting the parallelism of the cutting unit

- 1 Remove the front hood and right-hand fender.
- 2 Undo the nuts on the lift strut.

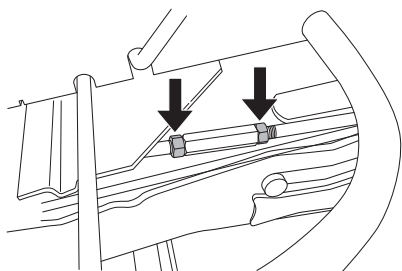

- 3 Screw out (extend) the stay to raise the rear edge of the cover.

Screw in (shorten) the stay to lower the rear edge of the cover.

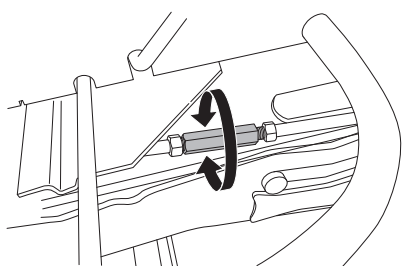

- 4 Tighten the nuts after adjustment.
- 5 On completion of the adjustment the unit's parallelism should be re-checked.
- 6 Fit the right-hand fender and the front hood.

Replacing the cutting unit belts



WARNING! Wear gloves to protect your hands when working with the blades.

There is a risk of crush injuries when working with the belt.

On these cutting units with collision-proof blades, the blades are driven by one V-belt. Do as follows to change the V-belt:

- 1 Remove the cutting unit.
- 2 Open the lock for the track rod bolt.

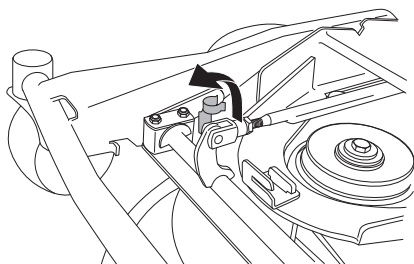

Remove the bolt so the track rod is released in one end.

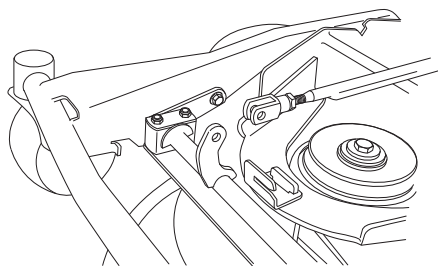

- 3 Unscrew the bolt holding the unit frame bracket.

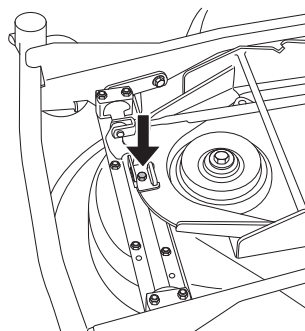

- 4 Remove the lock and pass the unit frame out.

- 5 Remove the two bolts on the unit frame.

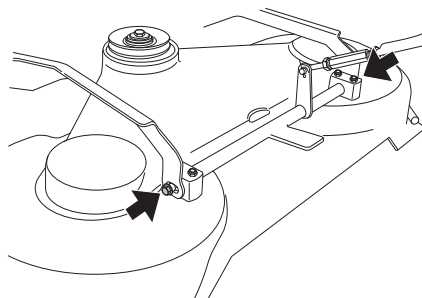

- 6 Remove the screws on the cutting cover. Lift the unit frame and remove the cutting unit cover.

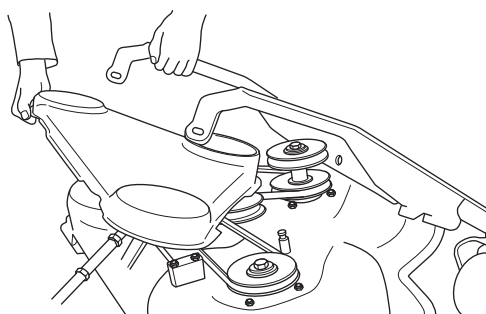

- 7 Loosen the spring that tensions the V-belt and pry off the belt.

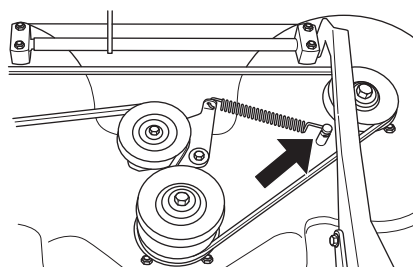

Simply reverse the procedure to fit the new belt.

Maintenance

Service position for the cutting unit

The cutting head can be placed in the service position to provide easy access for cleaning, repairs and servicing. In the service position the cutting unit is raised and locked in the vertical position.

Placing in the service position

- 1 Position the machine on flat ground. Apply the parking brake.
- 2 Set the cutting height control in the lowest position and lift up the cutting unit.

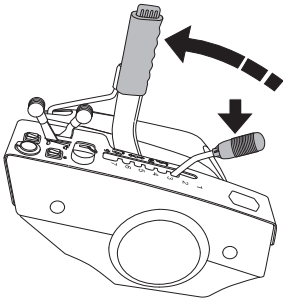

- 3 Remove the front hood by removing the pin. (There are complete instructions on using the service position inside the front hood).

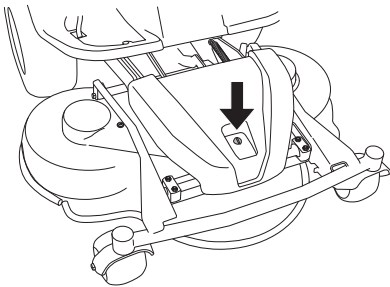

WARNING! Wear protective glasses when dismantling the cutting unit. The spring which tensions up the belt may break and cause personal injury.

- 4 Disengage the spring for the drive belt tensioning wheel.

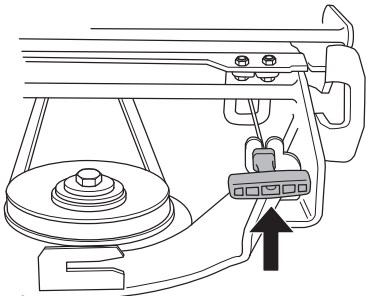

Loosen on the cutting height stay and place in the holder.

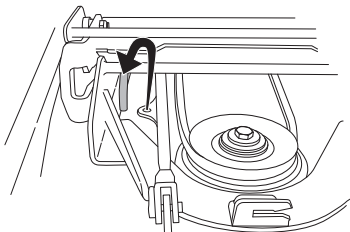

WARNING! Observe caution to avoid trapping your hand.

- 5 Remove the drive belt and place it in the belt holder.

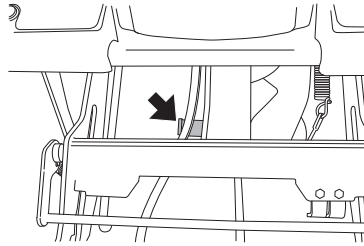

- 6 Grip the front edge of the unit and pull forwards until it stops.

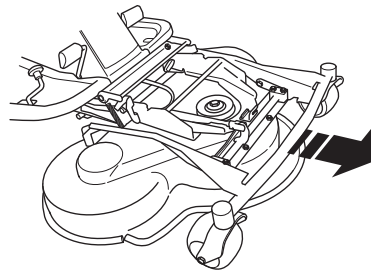

- 7 Lift the unit until it stops and a clicking sound is heard. The unit locks automatically in the vertical position.

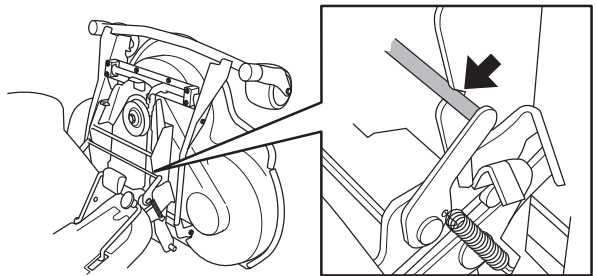

Restoring from service position

- 1 Grip the front edge of the unit and loosen the lock, fold down and slide in the unit.
- 2 Replace the cutting height stay and the belt.

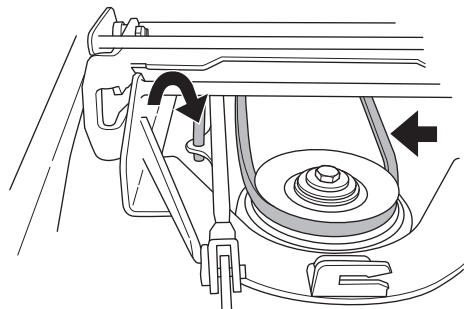

- 3 Tension the belt with the belt adjuster.
- 4 Fit the front cover.

Checking the blades

To achieve the best mowing results it is important that the blades are undamaged and well-sharpened.

Check that the blades' attachment screws are tight.

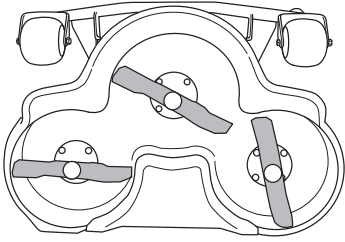

If the blades hit a foreign body such as a stone, they should be inspected before using them again.

IMPORTANT INFORMATION Replacing or sharpening the blades should be conducted by an authorised service workshop.

The blades should be balanced after sharpening. Let the service centre assess whether the blade can be sharpened or must be replaced.

Removing the BioClip plug

To change a Combi unit from BioClip function to cutting unit with rear ejection, remove the BioClip plug located under the unit with three screws.

- 1 Put the unit in the service position, see Placing in the service position.
- 2 Remove the three screws holding the BioClip plug, and remove the plug.

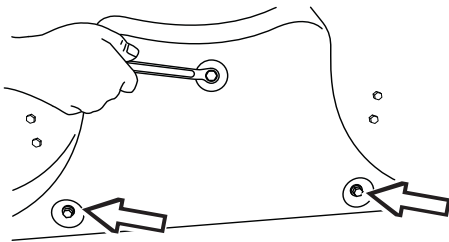

- 3 Tip: Fit three full-thread screws M8x15 mm in the screw holes to protect the threads.
 - 4 Replace the unit in normal position.
- Fit the BioClip plug in the reverse order.

Lubrication

General

Remove the ignition key to prevent unintentional movements during lubrication.

When lubricating with an oilcan, it ought to be filled with engine oil.

When lubricating with grease, unless otherwise stated, grease 503 98 96-01 or another chassis or ball bearing grease offering good corrosion protection shall be used.

If the machine is used daily it should be lubricated twice a week.

Wipe away excess grease after lubrication.

It is important to avoid getting lubricant on the belts or the drive surfaces on the belt pulleys. Should this happen, attempt to clean them with spirits. If the belt continues to slip after cleaning with spirits, it must be replaced.

Petrol or other petroleum products must not be used to clean belts.

Accessories

Lubrication or other maintenance of optional equipment or accessories is not described in this manual. This equipment too, naturally, requires maintenance. See the manuals for the respective accessories for instructions.

Lubricating the cables

Grease both ends of the cables and move the controls to end stop positions when lubricating.

Re-attach the rubber covers on the cables after lubrication.

Cables with sheaths will jam if they are not lubricated regularly. A jammed cable may cause malfunction, such as the parking braking being applied. If a cable binds, remove the cable and hang it vertically. Lubricate it with thin engine oil until the oil begins to escape from the bottom.

A tip: Fill a small plastic bag with oil and tape it so that it seals against the casing and allow the cable to hang vertically from the bag overnight. If you do not succeed in lubricating the cable, it must be replaced.

Cutting unit

Remove the front cover.

Lubricate with oil.

- Joints and bearings

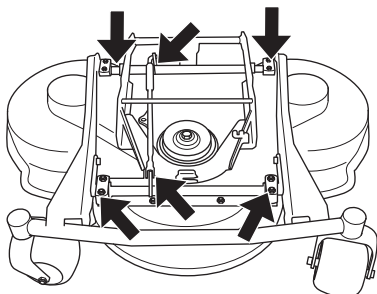

Pedal system in the frame tunnel

Lubricate the pedal system in the frame tunnel.

- Remove the cover of the frame tunnel by loosening the screws (two on the steering servo housing).

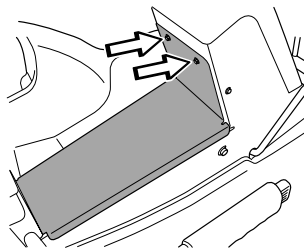

- Work the pedals and lubricate the moving parts with oil. Lubricate the cables for the brake and drive pedals with oil.

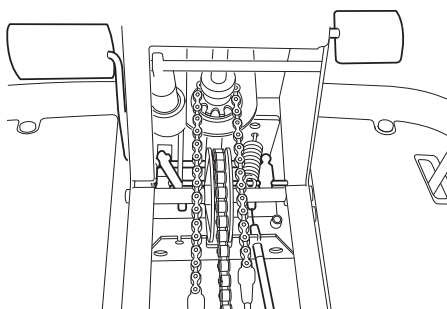

Chains in the frame tunnel

Remove the frame plate by loosening the two screws.

Lubricate the chains in the frame tunnel with oil or chain lubricant spray. Lubricate the steering cable pulley axle with grease.

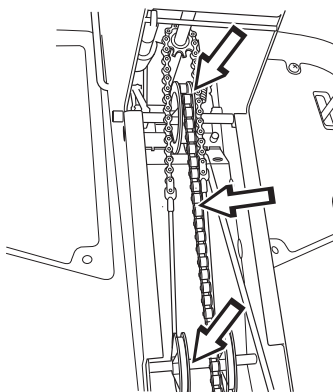

Links and joints in the cutting adjustment

Lubricate the links and the joints for the cutting height adjustment stay behind the right front wheel. Lubricate with oil.

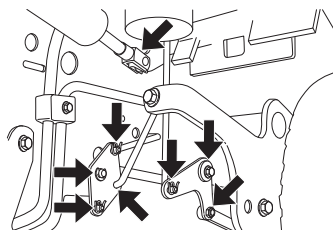

Lubrication

Driver seat

Fold up the seat.

Lubricate the lengthways adjustment runners with oilcan.

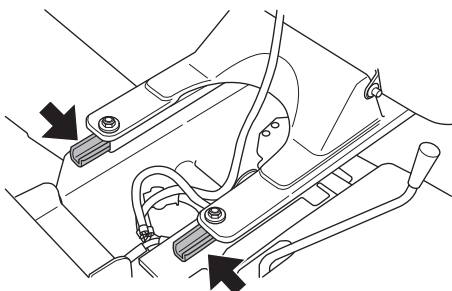

Throttle and choke cables, lever bearings

- Remove the right side cover on the lever housing (3 screws) and open the engine cover.
- Lubricate the cables' free ends with the oilcan, even those by the engine.
- Move the controls to the end points and lubricate again.

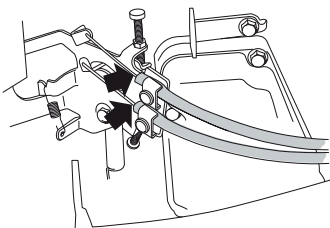

- Lubricate the joints, catches, and bearings for the cutting unit's control levers with oil.

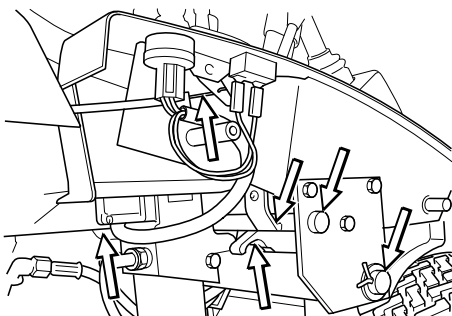

Replace the lever housing's side cover.

Lubricating the belt adjuster

Lubricate using a grease gun, 1 nipple from the right-hand side under the engine's lower belt pulley, until grease is forced out.

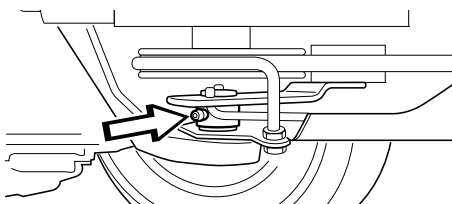

Use only good quality molybdenum disulphide grease.

Grease from well-known brand names (petrochemical companies, etc.) usually maintains a good quality.

Checking the engine's oil level.

Check the oil level in the engine when the Rider stands horizontal with the engine switched off. Do not check the oil with the engine running.

Open the engine cover.

Loosen the dipstick, pull it up and wipe it off.

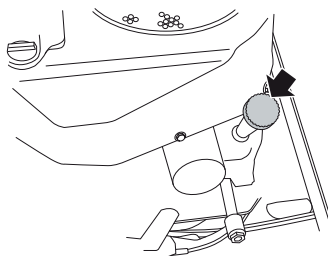

Now insert the dipstick again, **without tightening it**.

Pull the dipstick out again and read the oil level.

The oil level should be between the markings on the dipstick. If the level is approaching the ADD mark, top up the oil to the FULL mark on the dipstick.

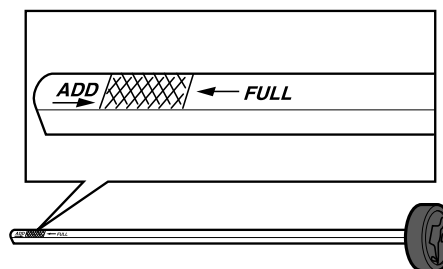

The oil is topped up through the hole the dipstick sits in. Fill the oil slowly.

Tighten the dipstick correctly before starting the engine. Start and run the engine at idling speed for approx. 30 seconds. Turn off the motor. Wait 30 seconds and check the oil level. If necessary fill so that the oil comes up to the FULL mark on the dipstick.

The following oil classes are recommended:

- API Service Class: SF, SG, SH and SJ

Choose an oil with viscosity according to the temperature ranges in the figure:

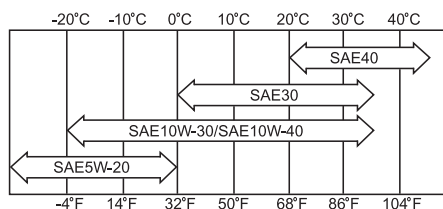

Do not mix different types of oil.

Caution when using oils such as 5W-20, 10W-30 and 10W-40 the engine's oil consumption increases. If these oils must be used, check the oil level frequently.

Lubrication

Replacing the engine oil

Open the engine cover.

The engine oil should be changed the first time after 8 hours running time. It should then be changed after every 100 hours of running time.

When operating with a heavy load or at high ambient temperatures, replace every 50 hours.



WARNING! Engine oil can be very hot if it is drained directly after stopping the engine. Allow the engine to cool somewhat first.

- 1 Place a container underneath the engine oil drain plug.

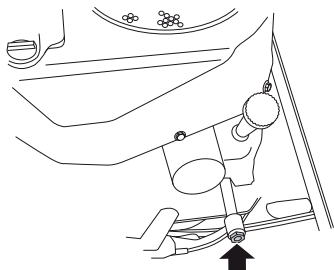

- 2 Remove the dipstick. Remove the drain plug from the engine's left side.
- 3 Let the oil run out into the container.
- 4 Fit the drain plug and tighten it.
- 5 If necessary fill so that the oil comes up to the FULL mark on the dipstick. The oil is topped up through the hole the dipstick sits in.
- 6 Run the engine warm, then check that there is no leakage from the oil plug.

Check the engine oil level and top up if necessary.

IMPORTANT INFORMATION

Used engine oil, antifreeze etc. is a health hazard and must not be disposed of on the ground or in nature; it should always be disposed of at a workshop or appropriate disposal location.

Avoid skin contact; wash with soap and water in case of spills.

Lubricate the hydrostatic cable with links

Remove the transmission cover.

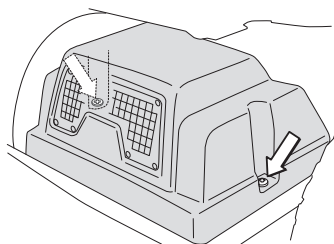

Lubricate the joints and bearings on the left side with oil.

Remove the rubber casing and lubricate the hydrostatic transmission cable with oil.

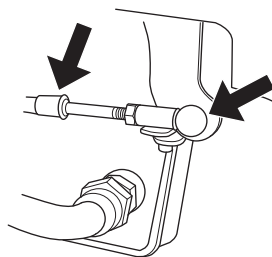

Press the pedal a few times, lubricate again and refit the rubber casing.

Replace the transmission cover.

Changing the oil filter



WARNING! Engine oil can be very hot if it is drained directly after stopping the engine. Allow the engine to cool somewhat first.

- Open the engine cover.
- Turn the old oil filter anti-clockwise to remove. If necessary, use a filter remover.

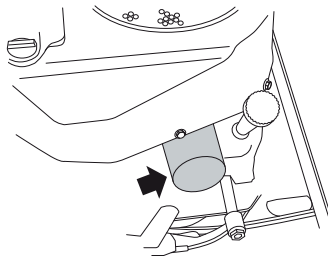

- Lightly lubricate the rubber seal on the new oil filter using new oil.
- Fit the oil filter by turning clockwise. Turn by hand until the rubber seal is seated. Now tighten a further half turn.
- Start the engine and let it idle for about 3 minutes. Now stop it and check for signs of leakage.
- Check the engine oil level and top up if necessary.

IMPORTANT!

Used engine oil and transmission oil is hazardous to health and must not be disposed of in the ground or out of doors.

Replaced filters must be handed in to the workshop or other allotted place for disposal.

Avoid skin contact; wash with soap and water in case of spills.

Lubrication

Hydraulic oil filter change

- Turn the old oil filter anti-clockwise to remove. If necessary, use a filter remover.

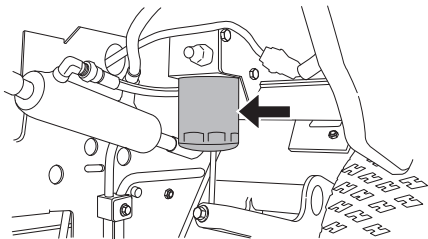

- Lightly lubricate the rubber seal on the new oil filter using new oil.
- Tighten the filter by hand until you feel it make contact, then tighten a further 3/4 turn. Remove the transmission cover and fill the transmission's oil tank, about 0.3 l oil. Be observant when running the engine as described below and fill so that the tank is not emptied.

Run the engine warm, manipulate the servo steering, and then check that there are no leaks around the oil filter seal.

- Check the oil level in the transmission, top up if necessary. The oil filter holds 0.3 litres of oil.
- Replace the transmission cover.

Lubricate the parking brake wire

R 418Ts

- Remove the transmission cover.
- Unhook the spring (A) from the screw (B).

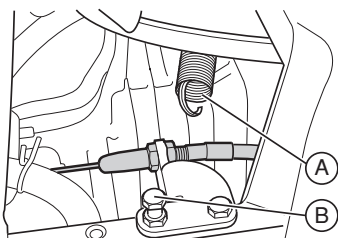

- Remove the cable's rubber casing when lubricating.
- Lubricate the cable with oil, press the brake pedal a few times and lubricate again.
- Refit the spring (A) and the transmission cover.

R 418Ts AWD

- Remove the frame plate by loosening the two screws.

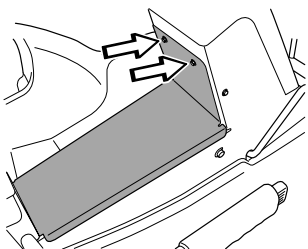

- Remove the left-hand wing cover.

- Lubricate both ends of the cable.

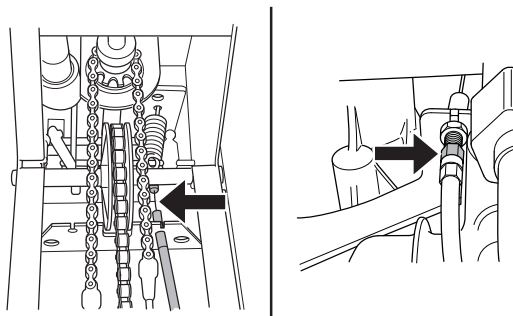

- Remove the cable's rubber casing when lubricating.
- Lubricate the cable with oil, press the parking brake pedal a few times and lubricate again.
- Refit the frame plate and wing cover.

Checking the transmission oil level

- Remove the transmission cover. Undo the two screws (one on each side) and lift off the transmission cover.

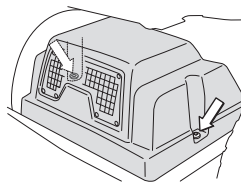

- Check that there is oil in the transmission's oil tank.

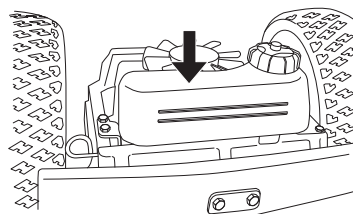

R 418Ts Fill if necessary with engine oil SAE 10W/40 (class SF-CC).

R 418Ts AWD Fill if necessary with oil Synthetic 10W/50

- Replace the transmission cover.

The oil and filter should be changed by an authorised service representative, as described in the Workshop Manual. Work on the system entails particular demands on cleanliness and the system must be vented before the machine is used.

Troubleshooting schedule

Problem	Cause
Engine does not start	There is no fuel in the fuel tank
	Spark plug defective
	Faulty spark plug connections or interchanged cables
	Dirt in the carburettor or fuel line
	Starter motor does not turn over the engine
Starter motor does not turn over the engine	Battery flat
	Bad contact between the cable and battery
	Lift lever for cutting unit in wrong position
	Main fuse blown.
	Ignition lock faulty
	Brake not activated.
	Faulty starter motor
Engine does not run smoothly	Faulty spark plug.
	Carburettor incorrectly set
	Air filter clogged
	Fuel tank vent blocked
	Ignition key defective
	Dirt in the carburettor or fuel line
	Choking or incorrectly adjusted throttle cable
Engine seems to have no power	Air filter clogged
	Spark plug defective
	Dirt in the carburettor or fuel line
	Carburettor incorrectly set
	Choking or incorrectly adjusted throttle cable
Engine overheats	Engine overloaded
	Spark plug defective
	Air intake or cooling flanges blocked
	Fan damaged
	Too little or no oil in engine
	Ignition defective
Battery does not charge	One or more battery cells faulty
	Poor contact on the battery terminal cable connectors
Machine vibrates	Blades are loose
	Engine is loose
	One or more blades unbalanced, caused by damage or poor balancing after sharpening
Uneven mowing	Blades blunt
	Long or wet grass
	Cutting unit skew
	Grass blockage under hood
	Different tyre pressures on right and left sides
	Over-speeding
	Engine speed too low
	Drive belt slipping

ELECTRICAL AND HYDRAULIC SYSTEMS

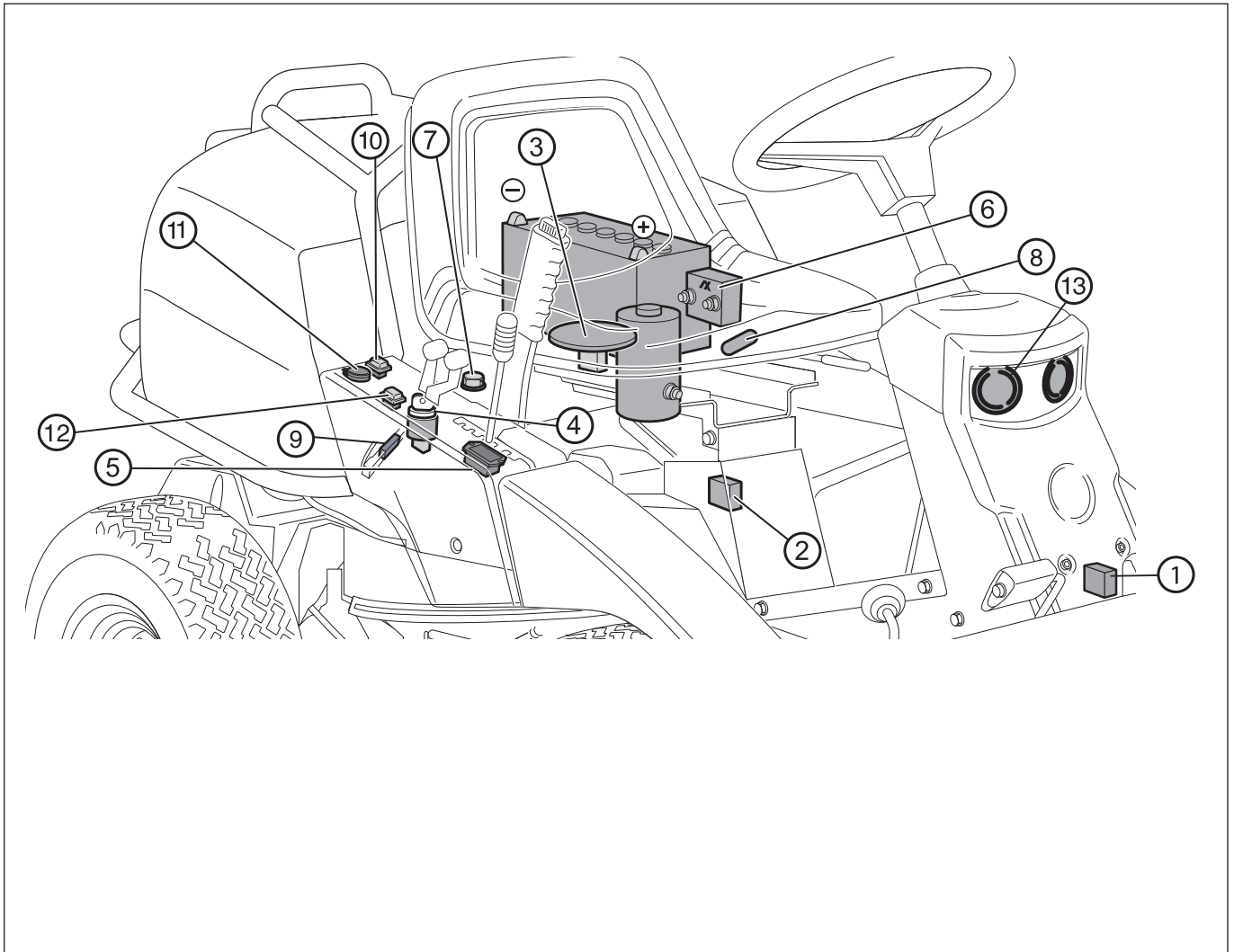

Numbers correspond to:

- | | | | |
|---|---------------------------------------|----|-----------------------------|
| 1 | Microswitch, hydrostatic transmission | 7 | Engine connectors |
| 2 | Microswitch, cutting unit | 8 | Main fuse 15 A |
| 3 | Microswitch, seat | 9 | Fuse 7.5 A |
| 4 | Ignition lock | 10 | Switch for the power outlet |
| 5 | Counter | 11 | Power outlet |
| 6 | Start relay | 12 | Switch for the lights |
| | | 13 | Lights |

Hydraulic System

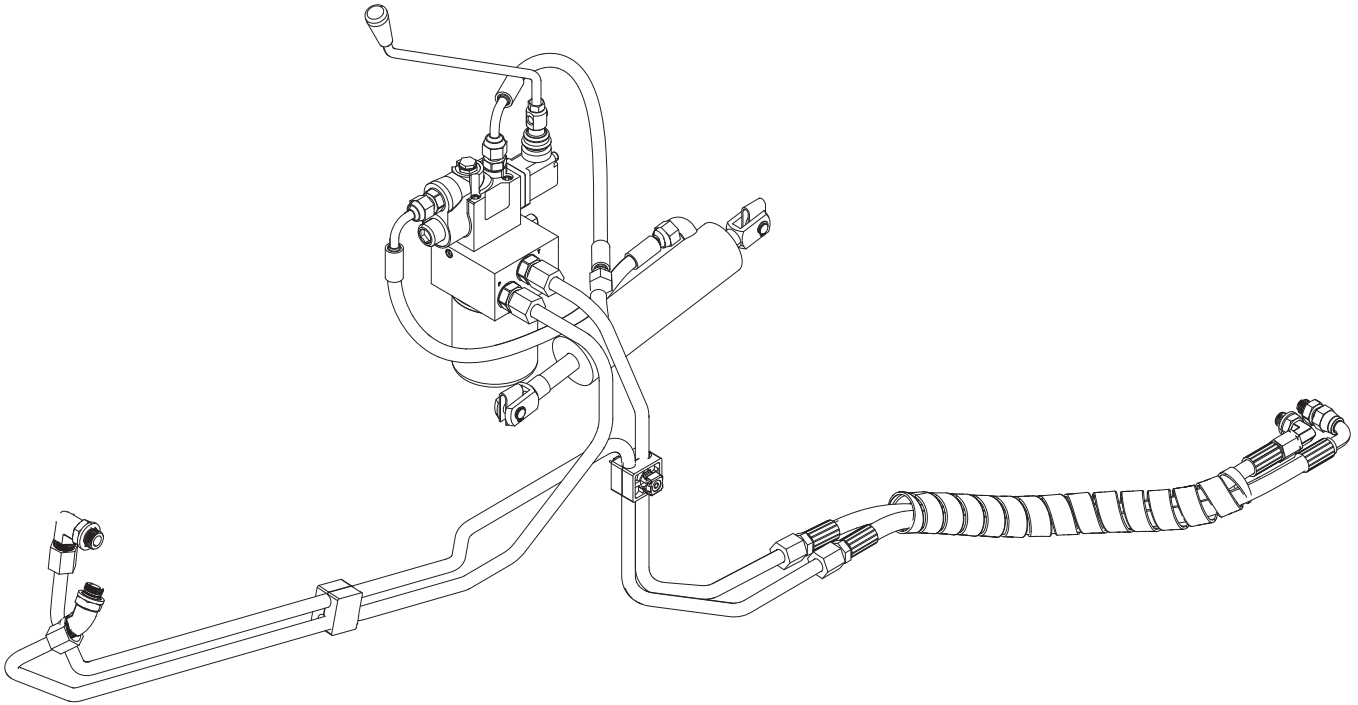

Keep the hydraulic system clean. Bear in mind that:

- Thoroughly clean before the top-up cap is opened or any connector loosened.
- Use clean containers when topping up the oil.
- Only use pure oil that has been stored in a sealed container.
- Do not reuse drained oil.
- Change the oil and filter according to the intervals specified in Maintenance Schedule.

In order for a hydraulic system to function without problem, it must be free from foreign objects. When used, the system produces particles, which can cause both wear and abnormal function. In order to remove these particles, the system contains filters. The filters are sized so as to capture the produced particles, but if contaminants are introduced from outside the system, the filters can quickly become clogged and fail to function as intended. If there are contaminants in the system, further contamination will be produced in a self-propagating cycle. The result will be operating disruptions and much work to clean the system.

Storage

Winter storage

At the end of the season, or if the machine is going to stand idle for more than 30 days, it should immediately be made ready for storage. Fuel which is left to stand for long periods (30 days or more) can leave tacky deposits which can block the carburettor and interfere with the engine.

Fuel stabiliser is an acceptable alternative to avoid tacky deposits during storage. If alkylate petrol (Aspen) is used stabiliser is not necessary since this fuel is stable. However, one should avoid changing from standard to alkylate petrol since sensitive rubber parts can harden. Add stabiliser to the fuel in the tank or the storage container. Always use the mixing ratios indicated by the manufacturer. Run the engine for at least 10 minutes after adding the stabiliser so that it will reach the carburettor. Do not empty the fuel tank and carburettor if stabiliser has been added.



WARNING! Never store a machine with fuel in the tank indoors or in poorly ventilated spaces where fuel vapour can come in contact with open flames, sparks, or a pilot light such as in a boiler, hot water tank, clothes drier, etc. Exercise caution when handling fuel. It is highly inflammable, and careless use can cause serious injury and damage to property. Drain off the fuel in an approved container outdoors and well clear of naked flames. Never use petrol for cleaning purposes. Use degreasing agents and hot water instead.

To prepare the machine for storage follow these instructions:

- 1 Carefully clean the machine, especially under the cutting unit. Touch-up paint damage to avoid rust.
- 2 Inspect the machine for worn or damaged parts and tighten loose screws and nuts.
- 3 Change the engine oil, and take care of the waste oil.
- 4 Empty the fuel tank. Start the engine and run it until the carburettor is emptied of fuel.
- 5 Remove the plugs and pour about a tablespoon of engine oil into each cylinder. Pull round the engine to distribute the oil and screw the plugs back on.
- 6 Grease all grease nipples, joints and axles.
- 7 Remove the battery. Clean it, charge it, and store it in a cool place.
- 8 Store the machine in a clean and dry place and cover it over for extra protection.

Guard

There is a cover to protect your machine during storage or transport. Contact your dealer for a demonstration

Service

Low season is the most suitable time to perform a service or overhaul of the machine in order to ensure high function safety during high season.

When ordering spare parts state your machine's purchase year, model, type, and serial number.

Always use genuine parts.

An annual check-up by an authorised servicing dealer is a good way to ensure that your ride-on mower performs at its best the following season.

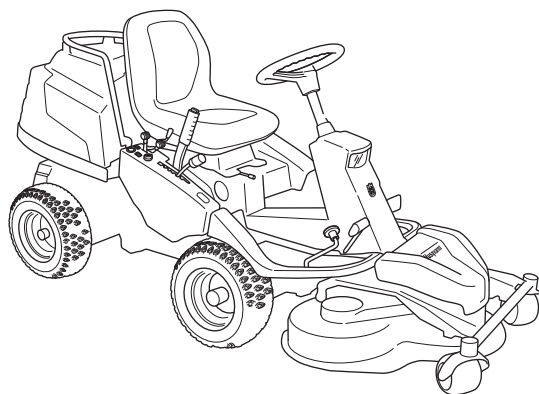

Technical data

	R 418Ts	R 418Ts AWD
Dimensions		
Length without cutting unit, cm/in	202 / 79,5	202 / 79,5
Width without cutting unit, cm/in	90 / 35,4	90 / 35,4
Height, cm/in	113 / 44,5	113 / 44,5
Unladen weight excluding cutting unit, kg/lb	288 / 634,9	299 / 651,2
Wheel base, cm/in	87 / 34,3	87 / 34,3
Track width, front, mm/ft	713 / 2,3	713 / 2,3
Track width, rear, mm/ft	710 / 2,3	710 / 2,3
Tyre dimensions	16 x 6,50 x 8	16 x 6,50 x 8
Air pressure, rear - front, kPa / bar / PSI	60 (0,6/8,5)	60 (0,6/8,5)
Max. gradient	10	10
Engine		
Brand / Model	Kawasaki / FS541V	Kawasaki / FS541V
Nominal engine output, kW (see note 1)	10,6	10,6
Displacement, cm ³ /cu.in	603/36,8	603/36,8
Oil, class SC-SH	SAE 30 or SAE 10W/30, SAE 10W/40	SAE 30 or SAE 10W/30, SAE 10W/40
Oil volume incl. filter	1,9/2.0	1,9/2.0
Oil volume excl. filter, litres/USqt	1,7/1,8	1,7/1,8
Starting	Electric starter	Electric starter
Max.motor speed, r/min	2900 ± 100	2900 ± 100
Fuel, minimum octane grade lead-free	87 (max. methanol 5%, max. ethanol 10%, max. MTBE 15%)	87 (max. methanol 5%, max. ethanol 10%, max. MTBE 15%)
Tank volume, litres/USqt	17/18	17/18
Electrical system		
Type	12 V, negative earthed	12 V, negative earthed
Battery	12 V, 24 Ah	12 V, 24 Ah
Spark plug	NGK BPR4ES	NGK BPR4ES
Electrode gap, mm/inch	0,75/0,030	0,75/0,030
Main fuse	Flat pin, 15 A.	Flat pin, 15 A.
Bulbs, halogen	2x12V 20W	2x12V 20W
Transmission		
Front axle make	-	KTM 10 SA
Rear axle make	Tuff Torq K 66	Tuff Torq K 664
Oil, class SF-CC	SAE 10W/40	SAE 10W/50 Synthetic
Oil volume, total, litres	3,2	3,2
Cutting unit		
Model	Combi 94 Combi 103 Combi 112	Combi 94 Combi 103 Combi 112

Note 1: The power rating of the engine indicated is the average net output (at specified rpm) of a typical production engine for the engine model measured to SAE standard J1349/ISO1585. Mass production engines may differ from this value. Actual power output for the engine installed on the final machine will depend on the operating speed, environmental conditions and other values.

Technical data

Technical data concerning the cutting unit			
Cutting unit	Combi 94	Combi 103	Combi 112
Cutting width, mm/inch	940/37	1030 / 41	1120 / 44.1
Cutting heights, 7 positions, mm/inch	25-75/0.98-2.95	25-75/0.98-2.95	25-75/0.98-2.95
Blade length, mm/inch	358/14.09	388/15.28	420 / 16,5
Width, mm	1030mm/41"	1120 / 44.1	1220 / 48

Technical specifications for sound and vibration levels						
	R 418Ts			R 418Ts AWD		
	Combi 94	Combi 103	Combi 112	Combi 94	Combi 103	Combi 112
Noise emissions (see note 2)						
Sound power level, measured dB (A)	97	97	97	97	97	97
Sound power level, guaranteed dB(A)	98	98	98	98	98	98
Sound levels (see note 3)						
Sound pressure level at the operators ear, dB(A)	83	83	83	83	83	83
Vibration levels (see note 4)						
Vibration level on the steering wheel, m/s ²	3,5	3,5	3,5	3,5	3.5	3.5
Vibration level in the seat, m/s ²	0,7	0,7	0,7	0,7	0,7	0,7

Note 2: Noise emissions in the environment measured as sound power (L_{WA}) in conformity with EC directive 2000/14/EC.

Note 3: Noise pressure level according to EN 836. Reported data for noise pressure level has a typical statistical dispersion (standard deviation) of 1.2 dB(A).

Note 4: Vibration level according to EN 836. Reported data for vibration level has a typical statistical dispersion (standard deviation) of 0.2 m/s² (steering wheel) and 0.8 m/s² (seat).

IMPORTANT INFORMATION When the service life of this product has been served and it is no longer used it should be returned to the dealer or to an applicable station for recycling.

IMPORTANT INFORMATION We reserve the right to change specifications and designs without prior notice so as to implement improvements.

Note that no legal claims are valid on the basis of information in this manual.

Use only genuine parts for repairs. The warranty is not valid if non genuine parts are used.

Technical data

EC-declaration of conformity (Applies to Europe only)

Husqvarna AB, SE-561 82 Huskvarna, Sweden, tel.: +46-36-146500, hereby declares that Husqvarna R 418Ts and R 418Ts AWD from 2013's serial numbers and onwards (the year is clearly stated in plain text on the rating plate with subsequent serial number), complies with the requirements of the COUNCIL'S DIRECTIVE:

of May 17, 2006 "relating to machinery" **2006/42/EC**

of December 15, 2004 "relating to electromagnetic compatibility" **2004/108/EC**.

of May 8, 2000 "relating to the noise emissions in the environment" **2000/14/EC**.

The following harmonised standards have been applied: **EN ISO 12100-2, EN-836**.

Notified body: **0404, SMP Svensk Maskinprovning AB**, Fyrisborgsgatan 3, SE-754 50 Uppsala, has issued reports regarding the assessment of conformity according to annex VI of the COUNCIL'S DIRECTIVE of May 8, 2000 "relating to the noise emissions in the environment" 2000/14/EC.

The certificates have the numbers: **01 / 901 / 203**

Huskvarna December 5, 2012



Claes Losdahl, Development Manager/Garden Products (Authorized representative for Husqvarna AB and responsible for technical documentation.)



Original instructions

1155354-26



2012-12-18