

THS 500/48 Art. 8883

GB Operation Instructions

Telescopic Hedge Trimmer

D Betriebsanleitung

Teleskop-Heckenschere

F Mode d'emploi

Taille-haies télescopique

NL Gebruiksaanwijzing

Telescoop-heggenschaar

S Bruksanvisning

Teleskophäcksax

DK Brugsanvisning

Teleskopisk hækkeklipper

FI Käyttöohje

Teleskooppivarrellinen pensasleikkuri

N Bruksanvisning

Teleskop hekksaks

I Istruzioni per l'uso

Tagliasiepi telescopica

E Instrucciones de empleo

Recortasetos telescópico

P Manual de instruções

Corta sebes telescópico

PL Instrukcja obsługi

Nożyce do żywopłotu z trzonkiem teleskopowym

H Használati utasítás

Teleszkópos sövénynyíró

CZ Návod k obsluze

Teleskopické nůžky na živý plot

SK Návod na obsluhu

Teleskopické nožnice na živý plot

GR Οδηγίες χρήσης

Τηλεσκοπικό μπουρντουροψάλιδο

RUS Инструкция по эксплуатации

Телескопические ножницы для живой изгороди

SLO Navodilo za uporabo

Teleskopske škarje za živo mejo

HR Upute za uporabu

Teleskopske škare za živicu

SRB Uputstvo za rad

Teleskopske makaze za živicu

UA Інструкція з експлуатації

Телескопічний кущоріз

RO Instrucțiuni de utilizare

Trimmer telescopic pentru gard

TR Kullanma Kılavuzu

Teleskopik çit budayıcısı

BG Инструкция за експлоатация

Телескопична ножица за жив плет

AL Manual përdorimi

Prerëse ligustrash teleskop

EST Kasutusjuhend

Teleskoop-hekilõikur

LT Eksploatavimo instrukcija

Teleskopinės gyvatvorių žirkklės

LV Lietošanas instrukcija

Teleskopiskās dzīvžoga šķēres

GARDENA Telescopic Hedge Trimmer

THS 500/48

Original instructions.



This unit is not intended for use by persons (including children) with reduced physical, sensory or mental capabilities, or lack of experience and knowledge, unless they have been given supervision or instruction concerning use of the unit by a person responsible for their safety. Children should be supervised to ensure that they do not play with the unit.

Intended use:

This GARDENA Telescopic Hedge Trimmer is used to cut hedges, shrubs and grass coverings in private domestic gardens and allotments.

DANGER! Risk of injury! Do not use the unit to cut lawns/ lawn edges, to chop up material or to make compost.

Table of Contents:

1. SAFETY	2
2. ASSEMBLY	6
3. OPERATION	6
4. MAINTENANCE	8
5. STORAGE	9
6. TROUBLESHOOTING	9
7. TECHNICAL DATA	9
8. ACCESSORIES	10
9. SERVICE/WARRANTY	10

1. SAFETY

If not used properly this product can be dangerous. The warnings and safety instructions must be followed to ensure reasonable safety and efficiency in using this product. The operator is responsible for following the warnings and instructions in this manual and on the product. Never use the product unless the guards provided by the manufacturer are in the correct position.

Symbols on the unit:



Read operator's manual.



Wear safety glasses and ear protection.



Do not let the unit become wet with rain or other moisture. Do not leave the unit outdoors while it is raining.



Disconnect the mains cable if the cable becomes damaged or cut.



Risk of fatal injury due to electric shock!
Keep at least 10 m away from electricity lines.

General Power Tool Safety Warnings



WARNING! Read all safety warnings and all instructions. Failure to follow the warnings and instructions may result in electric shock, fire and / or serious injury.

Save all warnings and instructions for future reference. The term "power tool" in the warnings refers to your mains operated (corded) power tool or battery operated (cordless) power tool.

1) Work area safety

- a) **Keep work area clean and well lit.**
Cluttered or dark areas invite accidents.
- b) **Do not operate power tools in explosive atmospheres, such as in the presence of flammable liquids, gases or dust.**
Power tools create sparks which may ignite the dust or fumes.
- c) **Keep children and bystanders away while operating a power tool.**
Distractions can cause you to lose control.

2) Electrical safety

- a) **Power tool plugs must match the outlet. Never modify the plug in any way. Do not use any adaptor plugs with earthed (grounded) power tools.**
Unmodified plugs and matching outlets will reduce risk of electric shock.
- b) **Avoid body contact with earthed or grounded surfaces, such as pipes, radiators, ranges and refrigerators.**
There is an increased risk of electric shock if your body is earthed or grounded.
- c) **Do not expose power tools to rain or wet conditions.** *Water entering a power tool will increase the risk of electric shock.*
- d) **Do not abuse the cord. Never use the cord for carrying, pulling or unplugging the power tool. Keep cord away from heat, oil, sharp edges or moving parts.**
Damaged or entangled cords increase the risk of electric shock.
- e) **When operating a power tool outdoors, use an extension cord suitable for outdoor use.**

Use of a cord suitable for outdoor use reduces the risk of electric shock.

- f) **If operating a power tool in a damp location is unavoidable, use a residual current device (RCD) protected supply.** *Use of an RCD reduces the risk of electric shock.*

3) Personal safety

- a) **Stay alert, watch what you are doing and use common sense when operating a power tool. Do not use a power tool while you are tired or under the influence of drugs, alcohol or medication.**
A moment of inattention while operating power tools may result in serious personal injury.
 - b) **Use personal protective equipment. Always wear eye protection.** *Protective equipment such as dust mask, non-skid safety shoes, hard hat, or hearing protection used for appropriate conditions will reduce personal injuries.*
 - c) **Prevent unintentional starting. Ensure the switch is in the off-position before connecting to power source and/or battery pack, picking up or carrying the tool.**
Carrying power tools with your finger on the switch or energising power tools that have the switch on invites accidents.
 - d) **Remove any adjusting key or wrench before turning the power tool on.** *A wrench or a key left attached to a rotating part of the power tools may result in personal injury.*
 - e) **Do not overreach. Keep proper footing and balance at all times.** *This enables better control of the power tool in unexpected situations.*
 - f) **Dress properly. Do not wear loose clothing or jewellery. Keep your hair, clothing and gloves away from moving parts.**
Loose clothes, jewellery or long hair can be caught in moving parts.
 - g) **If devices are provided for the connection of dust extraction and collection facilities, ensure these are connected and properly used.** *Use of dust collection can reduce dust-related hazards.*
- #### 4) Power tool use and care
- a) **Do not force the power tool. Use the correct power tool for your application.**
The correct power tool will do the job better and safer at the rate for which it was designed.
 - b) **Do not use the power tool if the switch does not turn it on and off.**
Any power tool that cannot be controlled with the switch is dangerous and must be repaired.

- c) **Disconnect the plug from the power source and/or the battery pack from the power tool before making any adjustments, changing accessories, or storing power tools.** *Such preventive safety measures reduce the risk of starting the power tool accidentally.*
- d) **Store idle power tools out of the reach of children and do not allow persons unfamiliar with the power tool or these instructions to operate the power tool.** *Power tools are dangerous in the hands of untrained users.*
- e) **Maintain power tools. Check for misalignment or binding of moving parts, breakage of parts and any other condition that may affect the power tool's operation. If damaged, have the power tool repaired before use.** *Many accidents are caused by poorly maintained power tools.*
- f) **Keep cutting tools sharp and clean.** *Properly maintained cutting tools with sharp cutting edges are less likely to bind and are easier to control.*
- g) **Use the power tool, accessories and tool bits etc. in accordance with these instructions, taking into account the working conditions and the work to be performed.** *Use of the power tool for operations different from those intended could result in a hazardous situation.*

5) Service

Have your power tool serviced by a qualified repair person using only identical replacement parts. *This will ensure that the safety of the power tool is maintained.*

Hedge trimmer safety warnings:

- **Keep all parts of the body away from the cutter blade. Do not remove cut material or hold material to be cut when blades are moving. Make sure the switch is off when clearing jammed material.** *A moment of inattention while operating the hedge trimmer may result in serious personal injury.*
- **Carry the hedge trimmer by the handle with the cutter blade stopped. When transporting or storing the hedge trimmer always fit the cutting device cover.** *Proper handling of the hedge trimmer will reduce possible personal injury from the cutter blades.*
- **Hold the power tool by insulated gripping surfaces only, because the cutter blade may contact hidden wiring or its own cord.** *Cutter blades contacting a "live" wire may make exposed metal parts of the power tool "live" and could give the operator an electric shock.*

- **Keep cable away from the cutting area.** *During operation the cable may be hidden in shrubs and can be accidentally cut by the blade.*

Additional Safety Recommendations

Warning! Keep toddlers away when you assemble the unit.

Small parts can be easily swallowed. There is also a risk that the polybag can suffocate toddlers.

Work area safety

Only use the unit in the manner and for the functions described in these instructions.

The operator or user is responsible for accidents or hazards occurring to other people or their property.

While operation and transport pay special attention to the hazard for third parties posed by the increased working radius when the telescopic tube is extended.

Risk of stumbling. While operation pay attention to the cable.

Warning! When wearing hearing protection, and due to the noise produced by the unit, the operator may not notice persons approaching.

Do not use the unit when a thunderstorm is approaching.

Do not use the unit nearby a water.

Electrical safety

The British Standards Institute recommend the use of a Residual Current Device (R.C.D.) with a tripping current of not more than 30 mA. Check your R.C.D. every time you use it.

Before use, examine cable for damage, replace it if there are signs of damage or ageing.

If the replacement of the supply cord is necessary, this has to be done by the manufacturer or his agent in order to avoid a safety hazard.

Do not use the unit if the electric cables are damaged or worn.

Immediately disconnect from the mains electricity supply if the cable is cut, or the insulation is damaged. Do not touch the electric cable until the electrical supply has been disconnected.

Your electric cable must be untangled, tangled cables can overheat and reduce the efficiency of your unit.

Always disconnect the mains cable before disconnecting any plug, cable connector or extension cable.

Switch off, remove plug from mains and examine electric supply cable for damage or ageing before

winding cable for storage. Do not repair a damaged cable, send the unit to the next GARDENA service Center or dealer authorised by GARDENA.

Always wind cable carefully, avoiding kinking.

Use only on AC mains supply voltage shown on the product rating label.

Under no circumstances should an earth be connected to any part of the unit.

If the unit starts unintentionally when the mains plug is connected, disconnect the mains at once. Contact GARDENA Service to check the unit.

Warning! This unit makes an electromagnetic field while it operates. This field may under some conditions interfere with active or passive medical implants. To decrease the risk of conditions that can possibly injure or kill, we recommend persons with medical implants to speak with their physician and the medical implant manufacturer before operating.

Cables

Use only permitted extension cables as per HD 516.

→ Ask your electrical specialist.

Personal safety

Always wear suitable clothing, protective gloves, and stout shoes.

Avoid contact to the oil of the blade in particular when you react allergic with it.

Thoroughly inspect the area where the unit is to be used and remove all wires and other foreign objects.

All adjustments (inclining the blade head, altering the length of the telescopic tube) have to be made with the sheath in place, and the unit must not rest on the blade in the process.

Always hold the unit properly with both hands on both handles (A) and (B).

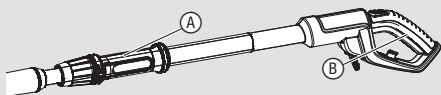

Before using the unit and after any impact, check for signs of wear or damage and repair as necessary.

Never attempt to use an incomplete unit or one with an unauthorised modification.

Power tool use and care

Know how to stop the unit quickly in an emergency.

Never hold the unit by the guard.

Do not use the unit if the protection equipments (protection cover, quick blade-stop) are damaged.

Do not use ladders whilst operating the unit.

Disconnect the mains cable:

- before leaving the unit unattended for any period;
 - before clearing a blockage;
 - before checking, cleaning or working on the appliance;
 - if you hit an object. Do not use your unit until you are sure that the entire unit is in a safe operating condition;
 - if the unit starts to vibrate abnormally. Check immediately. Excessive vibration can cause injury.
 - before passing to another person.
- Only use the unit between 0 – 40 °C.

Maintenance and storage



RISK OF INJURY!

Do not touch blades.

→ When finishing or interrupting work push up protection cover.

Keep all nuts, bolts and screws secure to be sure the unit is in safe working condition.

If the unit got hot during operation, let it cool down before storage.

2. ASSEMBLY

The hedger, blade, protective cover and the operation instructions are included in the scope of delivery.



DANGER! Risk of physical injury!

Cut injury when the unit starts accidentally.

→ Before you assemble the unit, make sure that the mains cable is disconnected and the protective cover ① is slid over the blade ②.



To assemble the telescopic handle:

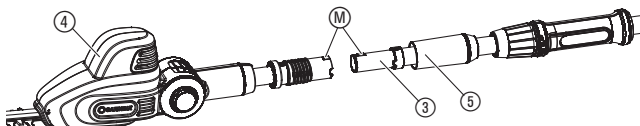
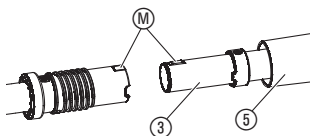

1. Slide the telescopic pipe ③ into the motor unit ④ until you reach the stop position. Ensure that the two markings M face each other.
2. Tighten the grey nut ⑤.

3. OPERATION



To connect the hedge trimmer:

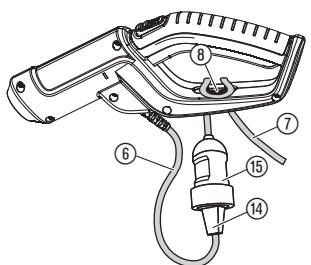

DANGER! Risk of physical injury!

Cut injury when the unit starts accidentally.

→ Before you connect, adjust or transport the unit, disconnect the mains cable and slide the protective cover ① over the blade ②.



DANGER! Risk of electric shock!

To avoid damage to the mains cable ⑥ the extension cable ⑦ must be inserted into the cable lock ⑧.

→ Before you operate the unit insert the extension cable ⑦ into the cable lock ⑧.

→ Never take hold of the protective cover ① when connecting the unit.

1. Loop the extension cable ⑦, insert the loop into the cable lock ⑧ and pull tight.
2. Connect the plug ⑭ of the unit into the socket ⑮ of the extension cable.
3. Connect the extension cable ⑦ into a 230 V mains socket.

Work positions:

The unit can be operated in 4 positions (illustration similar).



Side trimming:
Telescopic pipe retracted



Vertical trimming at high level:
Telescopic tube extended



Horizontal trimming at high level:
Motor unit tilted by 75°, telescopic pipe extended



Trimming at low level:
Motor unit tilted by -60°, telescopic pipe extended

To start the hedge trimmer:**DANGER! Risk of physical injury!**

Risk of injury if the unit does not stop when you release the start button.

→ **Do not bypass the safety devices or switches. For example do not attach the starting lock-out ⑪ or start button ⑬ to the handle.**

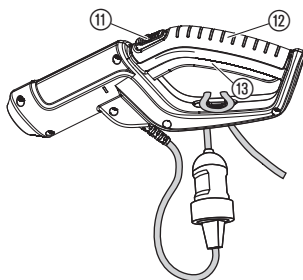
**To start:**

The unit is fitted with a starting lock-out ⑪ to prevent the unit from being turned on by accident.

1. Remove the protective cover ① from the blade ②.
2. Hold the telescopic pipe of the unit with one hand and the handle ⑫ with the other hand.
3. Push the starting lock-out ⑪ forwards and push the start button ⑬.

The unit will start.

4. Release the starting lock-out ⑪.

To stop:

1. Release the start button ⑬.
2. Slide the protective cover ① over the blade ②.

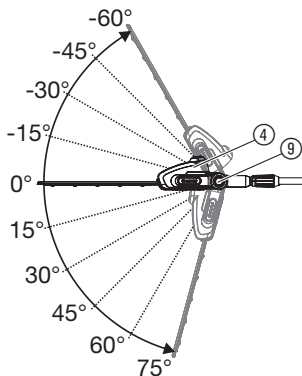
To tilt the motor unit:

For cutting at high and low level, the motor unit (4) can be tilted at an angle of 75° to -60° in 15° increments.

1. Keep the orange button (9) pressed.
2. Tilt the motor unit (4) in the required direction.
3. Release the orange button (9) and allow the motor unit (4) to engage.

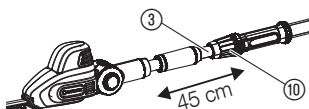
To extend the telescopic pipe:

For cutting at high and low heights, the telescopic pipe (3) can be continuously extended by up to 45 cm.

1. Loosen the orange nut (10).
2. Extend the telescopic pipe (3) to the required length.
3. Tighten the orange nut (10) again.

4. MAINTENANCE

**To clean the hedge trimmer:**

DANGER! Risk of physical injury!

Cut injury when the unit starts accidentally.

→ **Before you maintain the unit, make sure that the mains cable is disconnected and the protective cover (1) is slid over the blade (2).**



DANGER! Electric shock!

Risk of injury and risk of damage to property.

→ **Do not clean the unit with water or with a water jet (in particular high-pressure water jet).**

1. Clean the unit with a damp cloth.
2. Clean the airflow slots with a soft brush (do not use a screwdriver).
3. Lubricate the blade (2) with a low viscosity oil (e. g. GARDENA spray-oil Art. 2366). Avoid contact with the plastic parts.

5. STORAGE

To put into storage:



Disposal:
(in accordance with
RL2012/19/EC)



The unit must be stowed away from children.

1. Disconnect the mains cable.
2. Clean the unit (see 4. MAINTENANCE) and slide the protective cover ① over the blade ②.
3. Stow the unit in a dry area where it has protection from frost.

The unit must not be added to usual household waste. Refer to local environmental laws for discarding.

→ Important: Make sure that the unit is discarded through your municipal recycling collection centre.

6. TROUBLESHOOTING



DANGER! Risk of physical injury!

Cut injury when the unit starts accidentally.

→ Before you troubleshoot the unit, make sure that the mains cable is disconnected and the protective cover ① is slid over the blade ②.

Problem	Possible Cause	Remedy
Unit does not start	Extension cable not connected or damaged.	→ Connect the extension cable or if necessary replace it.
	Blade blocked.	→ Remove obstacle.
Unit can no longer be stopped	Start button is stuck.	→ Disconnect the mains cable and loosen start button.
Hedge is not cleanly cut	Blade blunt or damaged.	→ Have blade replaced by GARDENA Service.



For any other malfunctions please contact the GARDENA service department. Repairs must only be done by GARDENA service departments or specialist dealers approved by GARDENA.

7. TECHNICAL DATA

Telescopic Hedge Trimmer	THS 500/48 (Art. 8883)
Motor power consumption	500 W
Mains voltage/Mains frequency	230 V / 50 Hz
Strokes	1,600/min.
Length of blade	48 cm
Tooth gap of blade	25 mm
Range of extension of telescopic tube	0 – 45 cm

Weight	approx. 4.1 kg
Sound pressure level L_{PA}¹⁾ Uncertainty k_{PA}	86 dB (A) 2.5 dB (A)
Sound power level L_{WA}²⁾ Uncertainty k_{WA}	measured 96 dB (A) / guaranteed 98 dB (A) 2.5 dB (A)
Hand/arm vibration a_{vhw}³⁾	< 2.5 m/s ²

Measuring process complying with ¹⁾ DIN EN ISO 22868 ²⁾ RL 2000/14/EC ³⁾ DIN EN ISO 22867.



The stated vibration emission value has been measured according to a standardized test procedure and can be used for comparison of one electric power tool with another. It can also be used for preliminary evaluation of exposure. The vibration emission value can vary during actual use of the electric power tool.

8. ACCESSORIES

GARDENA Maintenance Oil

Extends the life of the blade.

Art. 2366

9. SERVICE/WARRANTY

Service:

Please contact the address on the back page.

Guarantee:

GARDENA guarantees this unit for 2 years (from date of purchase). This guarantee includes all important defects of the unit that can be proved to be material or manufacturing faults. Under warranty we will replace the unit or repair it for no cost if these conditions are applicable:

- The unit must have been used properly and in keeping with the requirements of the operation instructions.
- Neither the purchaser or a not approved third party have tried to repair the unit.

The blade and excentric drive are consumables and are not included in the guarantee.

This manufacturer's guarantee does not have an effect on the user's existing warranty claims against the dealer/seller.

If you have problems with this unit, please contact our Service or send the defective unit together with a short description of the problem – if there is a guarantee, with a copy of the receipt – post-age paid to one of the GARDENA Service Centers listed on the back of this leaflet.

GB Product Liability

We expressly point out that, in accordance with the product liability law, we are not liable for any damage caused by our units if it is because of improper repair or if parts replaced are not original GARDENA parts or approved parts, and, if the repairs were not done by a GARDENA Service Centre or an approved specialist. The same applies to spare parts and accessories.

D Produkthaftung

Wir weisen ausdrücklich darauf hin, dass wir nach dem Produkthaftungsgesetz nicht für durch unsere Geräte hervorgerufene Schäden einzustehen haben, sofern diese durch unsachgemäße Reparatur verursacht oder bei einem Teileaustausch nicht unsere originale GARDENA Teile oder von uns freigegebene Teile verwendet wurden und die Reparatur nicht vom GARDENA Service oder dem autorisierten Fachmann durchgeführt wird. Entsprechendes gilt für Ergänzungsstücke und Zubehör.

F Responsabilité

Nous vous signalons expressément que GARDENA n'est pas responsable des dommages causés par ses appareils, dans la mesure où ces dommages seraient causés suite à une réparation non conforme, dans la mesure où, lors d'un échange de pièces, les pièces d'origine GARDENA n'auraient pas été utilisées, ou si la réparation n'a pas été effectuée par le Service Après-Vente GARDENA ou l'un des Centres SAV agréés GARDENA. Ceci est également valable pour tout ajout de pièces et d'accessoires autres que ceux préconisés par GARDENA.

NL Productaansprakelijkheid

Wij wijzen er nadrukkelijk op, dat wij op grond van de wet aansprakelijkheid voor producten niet aansprakelijk zijn voor schade ontstaan door onze apparaten, indien deze door onvakkundige reparatie veroorzaakt zijn, of er bij het uitwisselen van onderdelen geen gebruik gemaakt werd van onze originele GARDENA onderdelen of door ons vrijgegeven onderdelen en de reparatie niet door de GARDENA technische dienst of de bevoegde vakman uitgevoerd werd. Ditzelfde geldt voor extra-onderdelen en accessoires.

S Produktansvar

Tillverkaren är inte ansvarig för skada som orsakats av produkten om skadan beror på att produkten har reparerats felaktigt eller om, vid reparation eller utbyte, andra än Original GARDENA reservdelar har använts. Samma sak gäller för kompletteringsdelar och tillbehör.

DK Produktansvar

Vi gør udtrykkeligt opmærksom på, at vi i henhold til produktansvarsloven ikke er ansvarlige for skader forårsaget af vores udstyr, såfremt det sker på grund af uautoriserede reparationer eller hvis dele er skiftet ud og der ikke er anvendt originale GARDENA dele eller dele godkendt af os, eller hvis reparationerne ikke er udført af GARDENA-service eller en autoriseret fagmand. Det samme gælder for ekstra udstyr og tilbehør.

FI Tuotevastuu

Korostamme nimenomaan, että tuotevastuulain nojalla emme ole vastuussa laitteistamme johtuneista vahingoista, mikäli nämä ovat aiheutuneet epäasianmukaisesta korjauksesta tai osia vaihdettaessa ei ole käytetty alkuperäisiä GARDENA-varaosia tai hyväksymiämme osia ja korjauksen on suorittanut muu kuin GARDENA-huoltokeskus tai valtuuttamamme ammattihenkilö. Tämä pätee myös lisäosiin ja lisävarusteisiin.

I Responsabilità del prodotto

Si rende espressamente noto che, conformemente alla legislazione sulla responsabilità del prodotto, non si risponde di danni causati da nostri articoli se originati da riparazioni eseguite non correttamente o da sostituzioni di parti effettuate con materiale non originale GARDENA o comunque da noi non approvato e, in ogni caso, qualora l'intervento non venga eseguito da un centro assistenza GARDENA o da personale specializzato autorizzato. Lo stesso vale per le parti complementari e gli accessori.

E Responsabilidad de productos

Advertimos que conforme a la ley de responsabilidad de productos no nos responsabilizamos de daños causados por nuestros aparatos, siempre y cuando dichos daños hayan sido originados por arreglos o reparaciones indebidas, por recambios con piezas que no sean piezas originales GARDENA o bien piezas no autorizadas por nosotros, así como en aquellos casos en que la reparación no haya sido efectuada por un Servicio Técnico GARDENA o por un técnico autorizado. Lo mismo es aplicable para las piezas complementarias y accesorios.

P Responsabilidade sobre o produto

Queremos salientar que segundo a lei da responsabilidade do fabricante, nós não nos responsabilizaremos por danos causados pelo nosso equipamento, quando estes ocorrerem em decorrência de reparações inadequadas ou da substituição de peças por peças não originais da GARDENA, ou peças não autorizadas.

A responsabilidade tornar-se-á nula também depois de reparações realizadas por oficinas não autorizadas pela GARDENA. Esta restrição valerá também para peças adicionais e acessórios.

PL Odpowiedzialność za produkt

Zwracamy Państwa uwagę, że nie ponosimy odpowiedzialności za uszkodzenia naszych maszyn, bądź szkody spowodowane ich wadliwym funkcjonowaniem, powstałe na skutek nieprawidłowo przeprowadzonych napraw lub użycia nieoryginalnych części zamiennych. Naprawy winny być przeprowadzane tylko przez punkty serwisowe Husqvarna lub autoryzowane serwisy. Dotyczy to również części uzupełniających i oprzyrządowania.

H Termékszavatosság

Nyomatékosan utalunk arra a tényre, hogy a termékszavatossági törvény szerint nem kell jótállást vállalnunk azokra a károokra, amelyeket nem a mi készülékeink okoztak, ha ezeket szakszerűtlen javítás okozta vagy egy alkatrész kicserélésénél nem a mi eredeti GARDENA alkatrészeinket vagy általunk engedélyezett alkatrészeket használták fel és a javítást nem a GARDENA szerviz vagy egy erre felhatalmazott szakember végezte. Hasonlóképpen érvényes ez a kiegészítő alkatrészekre és tartozékokra is.

CZ Odpovědnost za výrobek

Výslovně upozorňujeme na to, že podle zákona o odpovědnosti za výrobek neneseme odpovědnost za škody způsobené našimi přístroji, pokud byly způsobené neodbornou opravou nebo použitím jiných než našich originálních náhradních dílů GARDENA nebo námi schválených dílů a neprovedením opravy servisem GARDENA nebo autorizovaným odborníkem. Odpovídající platí i pro doplňkové díly a příslušenství.

SK Predmet záruky

Upozorňujeme dôrazne na to, že podľa zákona o poskytovaní záruk nezodpovedáme za škody spôsobené našimi výrobkami, v prípade, že boli boli vyvolané neodbornými opravami, výmenou dielcov, ktoré nepatria k originálnym dielom GARDENA alebo neboli nami schválené rovnako boli spôsobené servisnými zásahmi, ktoré neboli vykonané servisom GARDENA alebo autorizovaným odborníkom. Rovnako to platí pre doplnky a príslušenstvo.

GR Ευθύνη για το προϊόν

Σας υπενθυμίζουμε ρητά, ότι σύμφωνα με το νόμο περί ευθύνης για τα προϊόντα δεν ευθυνόμαστε για ενδεχόμενες βλάβες που προκαλούνται από τις συσκευές μας, εφόσον οφείλονται σε μία ακατάλληλη επισκευή ή σε μια αντικατάσταση τμημάτων για την οποία δεν έχουν χρησιμοποιηθεί τα πρωτότυπα ανταλλακτικά της GARDENA ή τα από μας συγκεκριμένα ανταλλακτικά και σε περίπτωση που δεν εκτελείται η επισκευή από το Τμήμα Εξυπηρέτησης Πελατών της GARDENA ή από έναν εξουσιοδοτημένο εξειδικευμένο τεχνίτη. Το ίδιο ισχύει για εξαρτήματα και συμπληρωματικά τμήματα.

SLO Jamstvo za izdelek

Pismo poudarjamo, da po zakonu jamstva za izdelek nismo odgovorni za škodo, ki bi nastala zaradi uporabe našega izdelka, prav tako tudi ne za škodo ki bi nastala zaradi nepravilnega popravila izdelka ali pri napačni zamenjavi delov, ki niso originalni deli GARDENA ali pri uporabi z naše strani potrjenih delov, ki pa niso bili vgrajeni v servisu GARDENA ali v naši pooblašteni servisni službi. Enako velja tudi za nadomestne dele in opremo.

HR Odgovornost za proizvod

Izričito napominjemo da u skladu sa Zakonom o odgovornosti za proizvode nismo odgovorni za štete uzrokovane našim uređajima ako su one izazvane nestručnim popravkom ili u slučaju zamjene dijelova nisu korišteni originalni GARDENA dijelovi ili dijelovi koje smo odobrili i popravak nije izvršio GARDENA servis ili ovlašteni stručnjak. Isto vrijedi i za dodatne dijelove i pribor.

RO Responsabilitatea legala a produsului

Mentionam în mod expres ca, în concordanță cu responsabilitatea legală a produsului, nu suntem răspunzători de nici un accident provocat de produsele noastre dacă se datorează reparării necorespunzătoare sau dacă piesele de schimb nu sunt originale GARDENA sau aprobate de GARDENA, sau dacă reparațiile nu au fost efectuate de un Centru de Serviciu GARDENA sau un specialist autorizat. Aceleași prevederi se aplică și pieselor de schimb și accesoriilor.

BG Отговорност за качество

Изрично подчертаваме, че съгласно закона за отговорност за качество, ние не носим отговорност за вредите причинени от нашите уреди, ако същите са причинени от неправилен ремонт или при подмяната на части не са използвани оригинални части на GARDENA или части одобрени от нас и ремонта не е извършен от сервиз на GARDENA или оторизиран специалист. Същото важи за допълнителните части и принадлежности.

EST Tootevastutus

Juhime teie tähelepanu sellele, et tootevastutusseaduse kohaselt ei vastuta me meie seadmete poolt põhjustatud kahjude eest, kui need on tekkinud asjatundmatu paranduse tagajärjel või kui detaili vahetamisel ei kasutatud GARDENA originaalvaruosi ega meie poolt kasutatada lubatud varuosi ja kui parandustööd ei ole teinud GARDENA klienditeenindusspetsialistid ega meie volitatud spetsialistid. Sama kehtib lisetailide ja tarvikute kohta.

LT Atsakomybė už produkciją

Nurodome, kad remdamiesi Atsakomybės už produkciją įstatymu, neatsakome už nuostolius, sukeltus mūsų prietaisų, jei jie atsirado dėl netinkamo remonto, arba, jei keičiant dalis, buvo naudojamos neoriginalios GARDENA dalys arba dalys, kurių mes neleidome naudoti, o remontą atliko ne GARDENA servisas arba neįgaliotasis specialistas. Tas pats galioja papildomoms dalims ir priedams.

LV Produkta atbildība

Mēs skaidri norādām uz to, ka saskaņā ar Produktu atbildības likumu, mēs neatbildam par mūsu iekārtu radītiem zaudējumiem, ciktāl tos ir izraisījis neatbilstošs remonts vai daļu nomaiņa ar neoriginālām GARDENA daļām vai ne ar mūsu norādītajām detaļām un remontu nav veicis GARDENA serviss vai pilnvarots speciālists. Tas pats attiecas uz papildinošajām daļām un piederumiem.

<p>GB CE Declaration</p> <p>The undersigned Husqvarna AB, 561 82 Huskvarna, Sweden hereby certifies that, when leaving our factory, the units indicated below are in accordance with the harmonised EU guidelines, EU standards of safety and product specific standards. This certificate becomes void if the units are modified without our approval.</p>	<p>H EU-Megfelelőeségi nyilatkozat</p> <p>Alulírott, a Husqvarna AB, 561 82 Huskvarna, Sweden igazolja azt, hogy az alábbiakban megnevezett készülékek, az általunk forgalomba hozott kivitelben teljesítik a harmonizációs EU-irányelvek, az EU biztonsági szabványok és a termékre jellemző szabványok követelményeit.</p> <p>Ha a készülékeken a mi beleegyezésünk nélkül változtatást végeznek, akkor ez a nyilatkozat érvényét veszti.</p>
<p>D CE-Konformitätserklärung</p> <p>Der Unterzeichnete Husqvarna AB, 561 82 Huskvarna, Sweden bestätigt, dass die nachfolgende bezeichneten Geräte in der von uns in Verkehr gebrachten Ausführung die Anforderungen der harmonisierten EU-Richtlinien, EU-Sicherheitsstandards und produktspezifischen Standards erfüllen. Bei einer nicht mit uns abgestimmten Änderung der Geräte verliert diese Erklärung ihre Gültigkeit.</p>	<p>CZ Prohlášení o shodě EU</p> <p>Podepsaný Husqvarna AB, 561 82 Huskvarna, Sweden potvrzuje, že dále uvedené přístroje v rámci do provozu uvedeném provedení splňují požadavky harmonizačních směrnic EU, bezpečnostních norem EU a norem specifických pro výrobek. Při námi neschválené změně přístroje ztrácí toto prohlášení platnost.</p>
<p>F Certificat de conformité aux directives européennes</p> <p>Le constructeur, soussigné : Husqvarna AB, 561 82 Huskvarna, Sweden déclare que à la sortie de ses usines le matériel neuf désigné ci-dessous était conforme aux prescriptions des directives européennes énoncées ci-après et conforme aux règles de sécurité et autres règles qui lui sont applicables dans le cadre de l'Union européenne.</p> <p>Toute modification portée sur ce produit sans l'accord express de GARDENA supprime la validité de ce certificat.</p>	<p>SK EU-Vyhlasenie o zhode</p> <p>Nižšie uvedené firma Husqvarna AB, 561 82 Huskvarna, Sweden vyhlasuje, že uvedené zariadenia, ktoré uviedla na trh v tomto vyhotovení, spĺňajú požiadavky harmonizačných smerníc EU, bezpečnostných noriem EU a noriem špecifických pre výrobok.</p> <p>Pri zmene zariadenia, ktorá nebola odsúhlasená výrobcom stráca toto vyhlásenie platnosť.</p>
<p>NL EU-overeenstemmingsverklaring</p> <p>Ondergetekende Husqvarna AB, 561 82 Huskvarna, Sweden bevestigt, dat de volgende genoemde apparaten in de door ons in de handel gebrachte uitvoering voldoen aan de eis van, en in overeenstemming zijn met de EU-richtlijnen, de EU-veiligheidsstandaard en de voor het product specifieke standaard. Bij een niet met ons afgestemde verandering aan de apparaten verliest deze verklaring haar geldigheid.</p>	<p>GR Δήλωση Συμμόρφωσης προς τις Οδηγίες της ΕΕ</p> <p>Η υπογράφουσα Husqvarna AB, 561 82 Huskvarna, Sweden δηλώνει, ότι τα εξής αναφερόμενα εκδιδόμενα από την εταιρία μας προϊόντα ανταποκρίνονται σε όλες τις αναφορουμενες προδιαγραφές της ΕΕ, στα πρότυπα ασφαλείας της ΕΕ και στα ειδικά για το προϊόν πρότυπα.</p> <p>Σε μία μη συμφωνημένη με την εταιρία μας τροποποίηση των συσκευών αυτή η δήλωση χάνει την ισχύ της.</p>
<p>S EU Tillverkarintyg</p> <p>Undertecknad firma Husqvarna AB, 561 82 Huskvarna, Sweden intygar härmed att nedan nämnda produkter överensstämmer med EU:s direktiv, EU:s säkerhetsstandard och produktspecifikation.</p> <p>Detta intyg upphör att gälla om produkten ändras utan vårt tillstånd.</p>	<p>SLO EU-izjava o skladnosti</p> <p>Podpisani proizvajalec »Husqvarna AB, 561 82 Huskvarna, Sweden« s podpisom potrjuje, da sledeče opisana naprava, ki smo jo poslali na tržišče izpolnjuje zahteve harmoniziranih standardov ES-smernic, ES-varnostnih standardov in izdelku specifičnih standardov.</p> <p>V primeru spremembe na napravi brez našega pisnega dovoljenja ta izjava izgubi svoj pomen in veljavnost.</p>
<p>DK EU Overensstemmelse certifikat</p> <p>Undertegnede Husqvarna AB, 561 82 Huskvarna, Sweden bekræfter hermed, at enheder listede herunder, ved afsendelse fra fabrikken, er i overensstemmelse med harmoniserede EU retningslinier, EU sikkerheds standarder og produkt specifikations standarder. Dette certifikat træder ud af kraft hvis enhederne er ændret uden vor godkendelse.</p>	<p>HR Izjava o sukladnosti EU-a</p> <p>Dolje potpisana tvrtka Husqvarna AB, 561 82 Huskvarna, Sweden ovime potvrđuje da dolje navedeni uređaji u izvedbi plasirajući na tržište ispunjavaju zahtjeve harmoniziranih EU smjernica, EU sigurnosnih normi i normi za određene proizvode. Ova izjava postaje ništavna u slučaju izmjene uređaja koje nismo odobrili.</p>
<p>FI EU-yhdenmukaisuusvakuutus</p> <p>Allekirjoittanut Husqvarna AB, 561 82 Huskvarna, Sweden vakuuttaa, että allamainitut laitteet täyttävät tehtaatilamme lähtöessään yhdenmukaistetujen EU-direktiivien, EU-turvallisuusstandardien ja tuotekohtaisten standardien vaatimukset.</p> <p>Laitteisiin tehdyt muutokset, joista ei ole sovittu kanssamme, johtavat tämän vakuutuksen raukaamiseen.</p>	<p>RO UE-Certificat de conformitate</p> <p>Prin prezenta Husqvarna AB, 561 82 Huskvarna, Sweden, certifica faptul ca, in momentul in care produsele mentionate mai jos ies din fabrica sunt in concordanta cu directivele UE, standardele de siguranta UE si standardele specifice ale produsului UE. Acest certificat devine nul in cazul modificarii aparatului fara aprobarea noastra.</p>
<p>I Dichiarazione di conformità alle norme UE</p> <p>La sottoscritta Husqvarna AB, 561 82 Huskvarna, Sweden certifica che il prodotto qui di seguito indicato, nei modelli da noi commercializzati, è conforme alle direttive armonizzate UE nonché agli standard di sicurezza e agli standard autorizzati di prodotto. Qualunque modifica apportata al prodotto senza nostra specifica autorizzazione invalida la presente dichiarazione.</p>	<p>BG ЕС-Декларация за съответствие</p> <p>Подписаната фирма Husqvarna AB, 561 82 Huskvarna, Sweden декларира, че описаните по-долу уреди, пуснати в продажба съгласно нашата спецификация, изпълняват изискванията на хармонизираните ЕС-директиви, ЕС-станданти за безопасност и специфичните производствени стандарти.</p> <p>При промяна на уреда, която не е съгласувана с нас, тази декларация губи своята валидност.</p>
<p>E Declaración de conformidad de la UE</p> <p>El que suscribe Husqvarna AB, 561 82 Huskvarna, Sweden declara que la presente mercancía, objeto de la presente declaración, cumple con todas las normas de la UE, en lo que a normas técnicas, de homologación y de seguridad se refiere. En caso de realizar cualquier modificación en la presente mercancía sin nuestra previa autorización, esta declaración pierde su validez.</p>	<p>EST ELI vastavusdeklaratsioon</p> <p>Allkirjutanu Husqvarna AB, 561 82 Huskvarna, Sweden kinnitab, et kirjeldatud seade vastab meie poole riiglesse viidud kujul ELi harmoniseeritud direktiividele, ELi ohutusstandarditele ja tootega seotud standarditele.</p> <p>Meiega kooskõlastamata muudatuse tegemise korral seadmel kaotab see deklaratsioon kehtivuse.</p>
<p>P Certificado de conformidade da UE</p> <p>Os abaixo mencionados Husqvarna AB, 561 82 Huskvarna, Sweden, por este meio certificam que ao sair da fábrica os aparelhos abaixo mencionados estão de acordo com as directrizes harmonizadas da UE, padrões de segurança e de produtos específicos.</p> <p>Este certificado ficará nulo se as unidades forem modificadas sem a nossa aprovação.</p>	<p>LT ES Atitikties deklaracija</p> <p>Pasirašanti įmonė Husqvarna AB, 561 82 Huskvarna, Sweden patvirtina, kad žemiau nurodyti prietaisai ir jų modeliai, kurie buvo pagaminti mūsų gamykloje atitinka ES direktyvas, ES saugumo standartus ir specifinius gaminių standartus.</p> <p>Atlikus bet kokį prietaiso pakeitimą, kuris nėra suderintas su mumis, ši deklaracija praranda galiojimą.</p>
<p>PL Deklaracja zgodności Unii Europejskiej</p> <p>Husqvarna AB, 561 82 Huskvarna, Sweden potwierdza, że poniżej określone urządzenia w wersji oferowanej przez nas do sprzedaży spełniają wymagania zharmonizowanych dyrektyw Unii Europejskiej, standardu bezpieczeństwa Unii Europejskiej i standardu specyficznego dla tego typu produktów.</p> <p>W przypadku zmiany urządzenia, która nie została z nami uzgodniona, niniejsza deklaracja traci moc obowiązującą.</p>	<p>LV ES-atbilstības deklaracija</p> <p>Parakstījies Husqvarna AB, 561 82 Huskvarna, Sweden, Vācija apstiprina, ka sekojoši apzīmētās iekārtas, kuras mēs izplātam, savā izpildījumā atbilst harmonizētajām ES direktīvām, ES drošības standartiem un produkta specifiskajiem standartiem.</p> <p>Ar mūsu neapstiprinātām izmaiņām iekārtā šī deklarācija zaudē savu derīgumu.</p>

<p>Description of the unit: Bezeichnung des Geräts: Désignation du matériel : Omschrijving van de apparaten: Produktbeskrivning: Beskrivelse af produktet: Laitteiden nimitys: Descrizione dei prodotti: Descripción de la mercancía: Descrição dos aparelhos: Nazwa urządzenia: A késztüelek megnevezése: Označení přístrojů: Označenie zariadenia: Ονομασία της συσκευής: Opis naprave: Oznaka uređaja: Descrierea articolelor: Обозначение на уредите: Seadmete nimetus: Prietaisų pavadinimas: Iekārtu apzīmējums:</p>	<p>Telescopic Hedge Trimmer Teleskop-Heckenschere Taille-haies télescopique Telescoop-heggenschaar Teleskophäckssax Teleskopisk hækkeklipper Teleskoopivarrellinen pensasleikkuri Tagliasiepi telescopica Recortasetos telescópico Corta sebes telescópico Nożyce do żywoplotu z trzonkiem teleskopowym Teleszkópos sövénynyíró Teleskopické nůžky na živý plot Teleskopické požnice na živý plot Τηλεσκοπικό μορντρουφιάλιο Teleskopske škarje za živo mejo Teleskopske škare za živicu Trimmer telescopic pentru gard Телескопична ножница за жив плет Teleskoop-hekilõikur Teleskopinis gyvatvorių žirklių Teleskopiskās dzīvzoga šķērēs</p>	<p>Noise level: Schall-Leistungspegel: Puissance acoustique : Geluidsniveau: Ljudnivá: Lyhdryksniveau: Melhru tehotaso: Livello rumorosità: Nível sonoro: Nível de ruído: Poziom natężenia dźwięku: Zajetjelisítény szint: Hluková hladina výkonu: Výkonová hladina hluku: Επίπεδο ισχύος ήχου: Nivo hrupa: Razina zvučne snage: Nível de putere acustică: Ниво на шума: Hellivõimsuse tase: Garso stiprumo lygis: Troksņu jaudas līmenis: measured/guaranteed gemessen/ garantiert mesurée/garantie gemeten/gegarandeerd uppmått/garanterad afmålt/garanti mitattu/ taattu testato/garantito medido/garantizado medido/garantido zmierzono/gwarantowane mért/garantált naměřeno/garantováno merand/garantovaná μετρήθηκαν/εγγυημένα izmerjeno/zagotovljeno izmereno/garantirano măsurat/garantat измерено/гарантирано môđedetud/garanteeritud išmatuotas/garantuotas izmērtais/garantētais</p>
<p>Product type: Typ-Bezeichnung: Désignation du modèle : Type-aanduiding: Typebetekening: Type-betegnelse: Typeypikuvaus: Tipologia: Designación del tipo: Designação do modelo: Oznaczenie typu:</p>	<p>Tipus megnevezése: Typové označení: Typ-označenie: Όνομασία τύπου: Neviz tipa: Oznaka tipa: Denumirea tipului: Тип-наименование: Típihi nimetus: Típo pavadinimas: Típa apzīmējums:</p>	<p>96 dB (A)/98 dB (A)</p> <p>Year of CE marking: Anbringningsjåhr der CE-Kennzeichnung: Année d'apposition du marquage CE : Installatiejaar van de CE-aanduiding: Mårkningår: CE-Mårkningår: CE-merkin kiinnitysvuosi: Anno di applicazione della certificazione CE: Colocación del distintivo CE: Ano de marcação pela CE: Rok nadania oznakowania CE: CE-jelzés elhelyezésének éve: Rok umístění značky CE:</p> <p>Rok udelenia značky CE: Έτος σήματος CE: Leto namestitve CE-oznake: Godina dobivanja CE oznake: Anul de marcarea CE: Година на поставяне на CE-маркировка: CE-mårgistuse paigaldamise aasta: Metali, kada pazyimeta CE-ženku: CE-marķējuma uzliškšanas gads:</p>
<p>CE-Directives: CE-Richtlinien: Directives CE : CE-richtlijnen: CE-direktiv: CE-direktiver: CE-merkinnåt: Direttive CE: Directivas CE: Diretivas CE: Dyrektywv CE: CE irányelvek: Směrnice CE: Označenie CE: Όδηγίες CE:</p>	<p>CE-direktive: CE smjernice: Directivele CE: CE-Директивы: CE direktiv: CE direktivos: CE direktivas: 2006/42/EC Machinery Directive 2004/108/EC (valid to 19.04.2016) 2014/30/EC (valid from 20.04.2016) 2000/14/EC 2011/65/EC</p>	<p>2015</p> <p>Authorized representative: Der Bevollmächtigte Le mandataire De gevolmachtigde Auktoriserad representant Autoriseret representant Valtuutettu edustaja Persona delegata La persona autorizada O reprezentante Pelnomocnik Meghatalmazott Zplnomocnenec Splnomocnený O εξουσιοδοτημένος Pooblaščenec Ovlaštena osoba Conducerea tehnică Упълномощен Volitatud esindaja Igalilottasis atstovavs Pilnvarotā persona</p>
<p>Harmonised EN: / Harmonisierte EN: EN 60745-1 EN 60745-2-15</p>	<p>EN ISO 12100 EN ISO 10517</p>	
<p>Deposited Documentation: GARDENA Technical Documentation, M. Kugler, 89079 Ulm Hinterlegte Dokumentation: GARDENA Technische Dokumentation, M. Kugler, 89079 Ulm Documentation déposée: Documentation technique GARDENA, M. Kugler, 89079 Ulm</p>	<p>Konformitätsbewertungsverfahren: Nach 2000/14/EG Art. 14 Anhang V Conformity Assessment according to: 2000/14/EC Procedure: art. 14 Annex V Procédure d'évaluation de la conformité: Selon 2000 /14 /CE art. 14 Annexe V</p>	<p>Ulm, 09.09.2015 Ulm, den 09.09.2015 Fait à Ulm, le 09.09.2015 Ulm, 09-09-2015 Ulm, 2015.09.09. Ulm, 09.09.2015</p> <p>Reinhard Pompe Reinhard Pompe (Vice President)</p>

Deutschland / Germany
GARDENA GmbH
Central Service
Hans-Lorenser-Straße 40
D-89079 Ulm
Produktfragen:
(+49) 731 490-123
Reparaturen:
(+49) 731 490-290
service@gardena.com

Albania
COBALT Sh.p.k.
Rr. Sirt Kodra
1000 Tirana

Argentina
Husqvarna Argentina S.A.
Av.del Libertador 5954 –
Piso 11 – Torre B
(C1428ARP) Buenos Aires
Phone: (+54) 11 5194 5000
info.gardena@
ar.husqvarna.com

Armenia
Garden Land Ltd.
61 Tigran Mets
0005 Yerevan

Australia
Husqvarna Australia Pty. Ltd.
Locked Bag 5
Central Coast BC
NSW 2252
Phone: (+61) (0) 2 4352 7400
customer.service@
husqvarna.com.au

Austria / Österreich
Husqvarna Austria GmbH
Industriezeile 36
4010 Linz
Tel.: (+43) 732 7701 01-485
service.gardena@
husqvarnagroup.com

Azerbaijan
Firm Progress
a. Aliyev Str. 26A
1052 Baku

Belgium
GARDENA Belgium NV/SA
Sterbeekstraat 163
1930 Zaventem
Phone: (+32) 2 70 92 12
Mail: info@gardena.be

Bosnia / Herzegovina
SILK TRADE d.o.o.
Industrijska zona Bukva bb
74260 Tešanj

Brazil
Husqvarna do Brasil Ltda
Av. Francisco Matarazzo,
1400 – 19º andar
São Paulo – SP
CEP: 05001-903
Tel: 0800-112252
marketing.br.husqvarna@
husqvarna.com.br

Bulgaria
Хускварна България ЕООД
Бул. „София Липчев“ № 72
1799 София
Тел.: (+359) 02/9753076
www.husqvarna.bg

Canada / USA
GARDENA Canada Ltd.
100 Summerlea Road
Brampton, Ontario L6T 4X3
Phone: (+1) 905 992 9330
info@gardena.canada.com

Chile
Maquinarias Agroforestales
Ltda. (Maga Ltda.)
Santiago, Chile
Avda. Chesterton
8355 comuna Las Condes
Phone: (+56) 2 202 4417
Dalton@мага.cl
Zipcode: 7560330
Temuco, Chile
Avda. Valparaíso # 01466
Phone: (+56) 45 222 126
Zipcode: 4780441

China
Husqvarna (China) Machinery
Manufacturing Co., Ltd.
No. 1355, Jia Xin Rd.,
Ma Lu Zhen, Jia Ding Dist.,
Shanghai
201801
Phone: (+86) 21 59159629
Domestic Sales
www.gardena.com.cn

Colombia
Husqvarna Colombia S.A.
Calle 18 No. 68 D-31, zona
Industrial de Montevideo
Bogotá, Cundinamarca
Tel. 571 2922700 ext. 105
jairo.salazar@
husqvarna.com.co

Costa Rica
Compania Exim
Euroiberoamericana S.A.
Los Colegios, Moravia,
200 metros al Sur del Colegio
Saint Francis – San José
Phone: (+506) 297 68 83
exim_euro@racsa.co.cr

Croatia
SILK ADRIA d.o.o.
Josipa Lončara 3
10090 Zagreb
Phone: (+385) 1 3794 580
silka.adria@zg.t-com.hr

Cyprus
Med Marketing
17 Digeni Akrita Ave
P.O. Box 27017
1641 Nicosia

Czech Republic
Husqvarna Česko s.r.o.
Türkova 2319/5b
149 00 Praha 4 – Chodov
Bezplatná infolinka:
800 100 425
servis@cz.husqvarna.com

Denmark
GARDENA / Husqvarna
Consumer Outdoor Products
Salgsafdelning Danmark
Box 9003
S-200 39 Malmö
info@gardena.dk

Dominican Republic
BOSQUESA, S.R.L
Carretera Santiago Licey
Km. 5 ½
Esquina Copal II.
Santiago
Dominican Republic
Phone: (+809) 736-0333
joserbosquesa@claro.net.do

Ecuador
Husqvarna Ecuador S.A.
Arupos E1-181 y 10 de
Agosto Quito, Pichincha
Tel: (+593) 22800739
francisco.jacome@
husqvarna.com.ec

Estonia
Husqvarna Eesti OÜ
Consumer Outdoor Products
Kesk tee 10, Aaviku küla
Rae vald
Harju maakond
75305 Estonia
kontakt.etj@husqvarna.ee

Finland
Oy Husqvarna Ab
Consumer Outdoor Products
Lautatarhankatu 8 / P L 3
00581 HELSINKI
info@gardena.fi

France
Husqvarna France
9/11 Allée des pierres mayettes
92635 Gennevilliers Cedex
France
http://www.gardena.com/fr
NF AZUR: 0 810 00 78 23
(Prix d'un appel local)

Georgia
ALD Group
Bellashvili 8
1159 Tbilisi

Great Britain
Husqvarna UK Ltd
Preston Road
Aycliffe Industrial Park
Newton Aycliffe
County Durham
DL5 6UP
info.gardena@
husqvarna.co.uk

Greece
Π.ΠΑΠΑΔΟΠΟΥΛΟΣ ΑΕΒΕ
Λεωφ. Αθηνών 92
Αθήνα
Τ.Κ.104 42
Ελλάδα
Τηλ. (+30) 210 51 93 100
info@papadopoulos.com.gr

Hungary
Husqvarna Magyarország Kft.
Ezred u. 1-3
1044 Budapest
Telefon: (+36) 1 251-4161
vevoszolgalat.husqvarna@
husqvarna.hu

Iceland
Ó. Johnson & Kaaber
Tunguhaltsí 1
110 Reykjavík
ooj@oik.is

Ireland
Husqvarna UK Ltd
Preston Road
Aycliffe Industrial Park
Newton Aycliffe
County Durham
DL5 6UP
info.gardena@
husqvarna.co.uk

Italy
Husqvarna Italia S.p.A.
Via Como 72
23866 VALMADRERA (LC)
Phone: (+39) 0341.203.111
info@gardenaitalia.it

Japan
KAKUICHI Co. Ltd.
Sumitomo Realty &
Development Kojimachi
BLDG., 8F
5-1 Nibancyo
Chiyoda-ku
Tokyo 102-0084
Phone: (+81) 33 264 4721
m_ishihara@kaku-ichi.co.jp

Kazakhstan
LAMED Ltd.
155/1, Tazhibayevoy Str.
050060 Almaty
IP Schmidt
Abayavenue 3B
110 005 Kostanay

Korea
Kyung Jin Trading CO.,LTD.
107-4, SunDuk Bld.,
YangJae-dong,
Seocho-gu,
Seoul, (zipcode: 137-891)
Phone: (+82) (0)2 574-6300

Kyrgyzstan
Alye Maki
ev. Molodaya Guardir J 3
720014
Bishkek

Latvia
Husqvarna Latvija
Consumer Outdoor Products
Bākižū iela 6
LV-1024 Rīga
info@husqvarna.lv

Lithuania
UAB Husqvarna Lietuva
Consumer Outdoor Products
Ateities pl. 77C
LT-52104 Kaunas
centras@husqvarna.lt

Luxembourg
Magasins Jules Neuberg
39, rue Jacques Stas
Luxembourg-Gasperich 259
Case Postale No. 12
Luxemburg 2010
Phone: (+352) 40 14 01
api@neuberg.lu

Mexico
AFOSA
Av. Lopez Mateos Sur # 5019
Col. La Calma 45070
Zapopan, Jalisco
Mexico
Phone: (+52) 33 3818-3434
icoimejo@afosa.com.mx

Moldova
Convel S.R.L.
290A Muncetti Str.
2002 Chisinau

Netherlands
GARDENA Nederland B.V.
Postbus 50176
1305 AD ALMERE
Phone: (+31) 36 521 00 00
info@gardena.nl

Neth. Antilles
Jonka Enterprises N.V.
Sta. Rosa Weg 196
P.O. Box 8200
Curaçao
Phone: (+599) 9 767 66 55
pgm@jonka.com

New Zealand
Husqvarna New Zealand Ltd.
PO Box 76-437
Manukau City 2241
Phone: (+64) (0) 9 9202410
support.nz@husqvarna.co.nz

Norway
GARDENA
Husqvarna Consumer
Outdoor Products
Salgskontor Norge
Kleiverveien 6
1540 Vestby
info@gardena.no

Peru
Husqvarna Perú S.A.
Jr. Ramón Cárcamo 710
Lima 1
Tel: (+51) 1 3320400 ext.416
juan.remuzgo@
husqvarna.com

Poland
Husqvarna
Poland Spółka z o.o.
ul. Wysockiego 15 b
03-371 Warszawa
Phone: (+48) 22 330 96 00
gardena@husqvarna.com.pl

Portugal
Husqvarna Portugal, SA
Lagaa – Albarraque
2635 – 595 Rio de Mouro
Tel.: (+351) 21 922 85 30
Fax : (+351) 21 922 85 36
info@gardena.pt

Romania
Madex International Srl
Soseaua Odaii 117-123,
RO 013603 Bucuresti, S1
Phone: (+40) 21 352.76.03
madex@ines.ro

Russia / Россия
ООО „Хускварна“
141400, Московская обл.,
г. Химки,
улица Ленинградская,
владение 39, стр.6
Бизнес Центр
„Химки Бизнес Парк“,
помещение 0802_04
http://www.gardena.ru

Serbia
Domel d.o.o.
Autoput za Novi Sad bb
11 273 Belgrade
Phone: (+381) 11 848 88 12
miroslav.jejina@domel.rs

Singapore
Hy-Ray PRIVATE LIMITED
40 Jalan Pemimpin
#02-08 Tat Ann Building
Singapore 577185
Phone: (+65) 6253 2277
shying@hyray.com.sg

Slovak Republic
Husqvarna Česko s.r.o.
Türkova 2319/5b
149 00 Praha 4 – Chodov
Bezplatná infolinka:
800 154 044
service@sk.husqvarna.com

Slovenia
Husqvarna Austria GmbH
Industriezeile 36
4010 Linz
Tel.: (+43) 732 77 01 01-485
service.gardena@
husqvarnagroup.com

South Africa
Husqvarna
Husqvarna (Pty) Ltd
Postnet Suite 250
Private Bag X6,
Cascades, 3202
South Africa
Phone: (+27) 33 846 9700
info@gardena.co.za

Spain
Husqvarna España S.A.
Calle de Rivas nº10
28052 Madrid
Phone: (+34) 91 708 05 00
atencioncliente@gardena.es

Suriname
Agrofix n.v.
Verlengde Hogestraat #22
Phone: (+597) 472426
agrofix@sr.net
Pobox : 2006
Paramaribo
Suriname – South America

Sweden
Husqvarna AB
S-561 82 Huskvarna
info@gardena.se

Switzerland / Schweiz
Husqvarna Schweiz AG
Consumer Products
Industriestrasse 10
5506 Mägenwil
Phone: (+41) (0) 62 887 37 90
info@gardena.ch

Turkey
GARDENA Dost Diş Ticaret
Müessesilik A.Ş.
Sanayi Cad. Adil Sokak
No: 1/B Kartal
34873 Istanbul
Phone: (+90) 216 38 93 939
info@gardena-dost.com.tr

Ukraine / Україна
ТОВ „Хускварна Україна“
вул. Васильківська, 34,
одіс 204-р
03022, Київ
Тел. (+38) 044 498 39 02
info@gardena.ua

Uruguay
FELI SA
Entre Rios 1083 CP 11800
Montevideo – Uruguay
Tel: (+598) 22 03 18 44
info@felisa.com.uy

Venezuela
Corporación Casa y Jardín C.A.
Av. Caroní, Edif. Trezmen, PB.
Colinas de Bello Monte.
1050 Caracas.
Tlf: (+58) 212 992 33 22
info@casayjardin.net.ve

8883-20.960.02/0915
© GARDENA
Manufacturing GmbH
D-89070 Ulm
http://www.gardena.com