

# INSTALLATION MANUAL

## GARDENA ROBOTIC LAWNMOWER

R38Li, R40Li, R45Li,  
R50Li, R70Li, R80Li

 **GARDENA®**





## **IMPORTANT INFORMATION!**

Keep in mind that the operator is responsible for accidents or hazards occurring to other people or their property.

Keep the Operator's manual in a safe way for future reference!

This appliance is not intended for use by persons (including children) with reduced physical, sensory or mental capabilities, or lack of experience and knowledge, unless they have been given supervision or instruction concerning use of the appliance by a person responsible for their safety. Children should be supervised to ensure that they do not play with the appliance.

This appliance can be used by children aged from 8 years and above and persons with reduced physical, sensory or mental capabilities or lack of experience and knowledge if they have been given supervision or instruction concerning use of the appliance in a safe way and understand the hazards involved.

Children shall not play with the appliance. Cleaning and user maintenance shall not be made by children without supervision.

Never connect the power supply to a outlet if plug or cord is damaged. Damaged or entangled cord increase the risk of electric shock.

Only charge the battery in the included charging station. Always use the original power supply unit. Incorrect use may result in electric shock, overheating or leaking of corrosive liquid from the battery. In the event of leakage of electrolyte flush with water/neutralizing agent, seek medical help if it comes in contact with the eyes.

Do not try to recharge non-rechargeable batteries.

The appliance must be disconnected from the supply mains when removing the battery.

---

# TABLE OF CONTENTS

---

<b>Introduction and safety</b> .....	<b>5</b>
Introduction .....	5
Symbols on the product .....	6
Symbols in the Operator s Manual .....	7
Safety Instructions .....	8
<b>Presentation</b> .....	<b>11</b>
What is what? .....	12
Package Contents .....	13
Function .....	14
Search method .....	16
<b>Installation</b> .....	<b>17</b>
Preparations .....	17
Installation of the charging station .....	18
Charging the battery .....	22
Installation of the boundary wire .....	23
Connecting the boundary wire .....	29
Installation of the guide wire .....	30
Checking the loop .....	34
First start-up and calibration .....	34
Test docking with the charging station .....	35
<b>Use</b> .....	<b>36</b>
Charging a flat battery .....	36
Using the timer .....	37
Starting .....	38
Stopping .....	38
Switching off .....	39
Adjusting the cutting height .....	39
<b>Control panel</b> .....	<b>40</b>
Operation selection .....	41
Multi-choice buttons .....	42
Numbers .....	42
Main switch .....	42
<b>Menu functions</b> .....	<b>43</b>
Main menu .....	43
Menu structure .....	44
Timer .....	46
Installation, R70Li, R80Li .....	49
Security .....	53
Settings .....	55
<b>Garden examples</b> .....	<b>59</b>
<b>Maintenance</b> .....	<b>63</b>
Winter storage .....	64
After winter storage .....	64
Cleaning .....	65
Transport and removal .....	66
In the event of a thunderstorm .....	66
Replacing the blades .....	67
Replacing the battery .....	67
<b>Troubleshooting</b> .....	<b>69</b>
Messages .....	69
Indicator lamp in the charging station .....	73
Symptoms .....	74
Finding breaks in the loop wire .....	76
<b>Technical Data</b> .....	<b>80</b>
<b>Guarantee terms</b> .....	<b>82</b>
<b>Environmental information</b> .....	<b>83</b>
<b>EU Declaration of Conformity</b> .....	<b>84</b>

---

# MEMO

---

**Serial number:** \_\_\_\_\_

**PIN code:** \_\_\_\_\_

**Product registration key:** \_\_\_\_\_

The Product Registration Key is a valuable document and must be stored in a safe place. This key is necessary for example to register the product on GARDENA's website or to unlock the robotic lawnmower in the event of a lost PIN code. The product registration key is provided in a separate document in the product packaging.

If the robotic lawnmower is stolen, it is important to notify GARDENA of this. Contact GARDENA Central Service and provide the robotic lawnmower's serial number and product registration key so that it can be registered as stolen in an international database. This is an important step in the robotic lawnmower's theft protection which reduces interest in the buying and selling of stolen mowers.

Always have the robotic lawnmower's serial number at hand when you contact GARDENA Central Service, as this will provide you with faster support.

**GARDENA Central Service**

**[www.gardena.com](http://www.gardena.com)**



## 1. Introduction and safety

### 1.1 Introduction

Congratulations on your choice of an exceptionally high quality product. To get the best results from your GARDENA robotic lawnmower requires knowledge of how it works. This Operator's Manual contains important information about the robotic lawnmower, how it must be installed and how to use it.

As a complement to this Operator's Manual, there is more information available on GARDENA's website, [www.gardena.com](http://www.gardena.com). Here you can find more help and guidance in the use of the robotic lawnmower.

[www.gardena.com](http://www.gardena.com)

The following system is used in the Operator's Manual to make it easier to use:

- Text written in *italics* is a text that is shown on the robotic lawnmower's display or is a reference to another section in the Operator's Manual.
- Words written in **bold** are one of the buttons on the robotic lawnmower's keypad.
- Words written in *UPPERCASE* and *italics* refer to the position of the main switch and the different operating modes available in the robotic lawnmower.

GARDENA has a policy of continuous product development and therefore reserves the right to modify the design and appearance and function of products without prior notice.

#### IMPORTANT INFORMATION

Please read the Operator's Manual carefully and make sure you understand the instructions before using your robotic lawnmower.



#### WARNING

The robotic lawnmower can be dangerous if incorrectly used.



#### WARNING

Never use the robotic lawnmower when persons, especially children, or pets, are in the cutting area.

---

# 1. INTRODUCTION AND SAFETY

---

## 1.2 Symbols on the product

These symbols can be found on the robotic lawnmower. Study them carefully.

- Please read the Operator's Manual carefully and make sure you understand the instructions before using your robotic lawnmower. The warnings and safety instructions in this Operator's Manual must be carefully followed if the mower is to be used safely and efficiently.



- The robotic lawnmower can only start when the main switch is set to 1 and the correct PIN code has been entered. Turn the main switch to 0 before carrying out any inspections and/or maintenance.



- Remain at a safe distance from the robotic lawnmower when it is running. Keep your hands and feet away from the rotating blades. Never put your hands or feet close to or under the body when the robotic lawnmower is running.

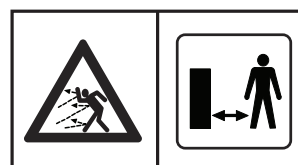

- Do not ride on the robotic lawnmower.



- This product conforms to the applicable EC Directives.



- Noise emission to surroundings. The product's emissions are set out in chapter 10, Technical data and on the rating plate.

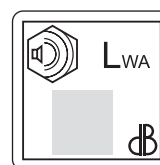

- It is not permitted to dispose of this product as normal household waste when it has reached the end of its useful life. Ensure that the product is recycled in accordance with local legal requirements.

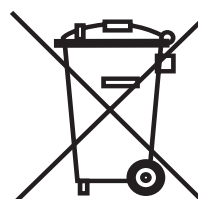

- Never use a high-pressure washer or even running water to clean the robotic lawnmower.

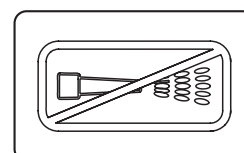



# 1. INTRODUCTION AND SAFETY

- The low voltage cable must not be shortened, extended or spliced.
- Do not use a trimmer nearby the low voltage cable. Be careful when trimming edges where the cables are placed.

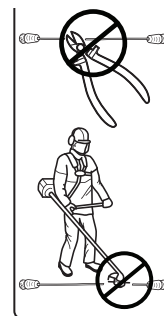

3012-1351

## 1.3 Symbols in the Operator s Manual

These symbols can be found in the Operator s Manual. Study them carefully.

- Turn the main switch to 0 before carrying out any inspections and/or maintenance.

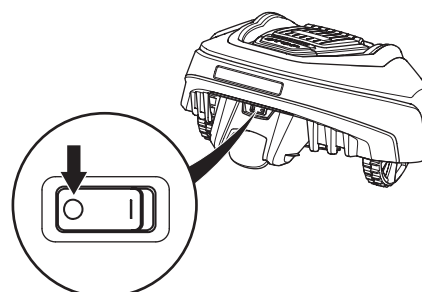

- Always wear protective gloves when working with the mower's chassis.



- Never use a high-pressure washer or even running water to clean the robotic lawnmower.

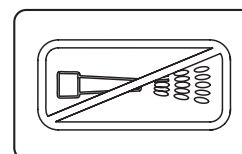

- A warning box indicates the risk of personal injury, especially if the instructions are not followed.

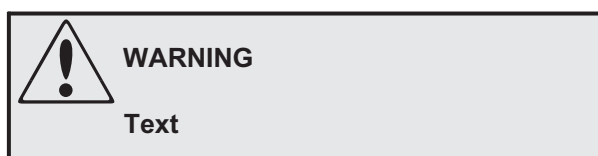

- An information box indicates the risk of material damage, especially if the instructions are not followed. The box is also used where there is a risk of user error.



---

# 1. INTRODUCTION AND SAFETY

---

## 1.4 Safety Instructions

### Use

- This robotic lawnmower is designed to mow grass in open and level ground areas. It may only be used with the equipment recommended by the manufacturer. All other types of use are incorrect. The manufacturer's instructions with regard to operation, maintenance and repair must be followed precisely.
- Never use the robotic lawnmower when persons, especially children, or pets, are in the cutting area. If there are persons, or pets, in the cutting area it is recommended that the lawnmower be programmed for use during hours when the area is free from persons, e.g. at night. See 6.3 Timer.
- The robotic lawnmower may only be operated, maintained, and repaired by persons that are fully conversant with its special characteristics and safety regulations. Please read the Operator's Manual carefully and make sure you understand the instructions before using the robotic lawnmower.
- It is not permitted to modify the original design of the robotic lawnmower. All modifications are made at your own risk.
- Check that there are no stones, branches, tools, toys or other objects on the lawn that can damage the blades and cause the mower to stop.
- Start the robotic lawnmower according to the instructions. When the main switch is in position 1, make sure you keep your hands and feet away from the rotating blades. Never put your hands and feet under the robotic lawnmower.
- Never lift up the robotic lawnmower or carry it around when the main switch is in position 1.
- Do not let persons who do not know how the robotic lawnmower works and behaves use the robotic lawnmower.
- The robotic lawnmower must never be allowed to collide with persons or other living creatures. If a person or other living creature comes in the lawnmower's way it shall be stopped immediately. See 4.4 Stopping.
- Do not put anything on top of the robotic lawnmower or its charging station.
- Do not allow the robotic lawnmower to be used with a defective blade disc or body. Neither should it be used with defective blades, screws, nuts or wires.
- Do not use the robotic lawnmower if the main switch does not work.
- Always switch off the robotic lawnmower using the main switch when the robotic lawnmower is not in

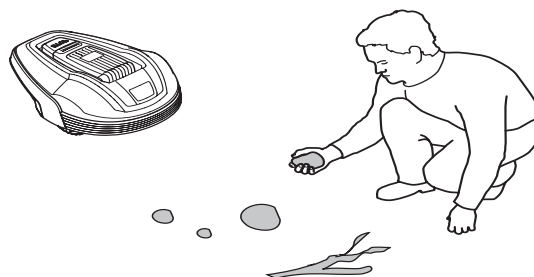



---

# 1. INTRODUCTION AND SAFETY

---

use. The robotic lawnmower can only start when the main switch is set to *1* and the correct PIN code has been entered.

- The robotic lawnmower must never be used at the same time as a sprinkler. In this case use the timer function (see *6.3 Timer* on page 46) so the mower and sprinkler never run simultaneously.
- The built-in alarm is very loud. Be careful, especially if the robotic lawnmower is handled indoors.
- Full compatibility cannot be guaranteed between the robotic lawnmower and other types of wireless systems such as remote controls, radio transmitters, hearing loops, buried electric animal fencing or similar.
- Metal objects in the ground (e.g. reinforced concrete or anti-mole nets) can result in a stoppage. The metal objects can cause interference with the loop signal which then can lead to a stoppage.

---

# 1. INTRODUCTION AND SAFETY

---

## Transport

The original packaging should be used when transporting the robotic lawnmower over long distances.

To safely move from or within the working area:

1. Press the **STOP** button to stop the robotic lawnmower. If security is set to the medium or high level (see 6.5 *Security* on page 53), the PIN code has to be entered. The PIN code contains four digits and is selected when you start the robotic lawnmower for the first time. See 3.8 *First start-up and calibration* on page 34.
2. Set the main switch in position 0.

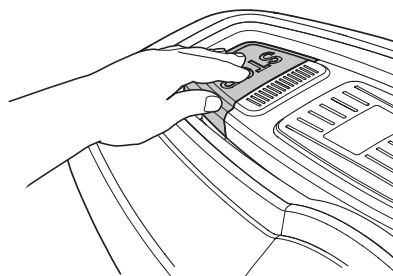

3. Carry the robotic lawnmower by the handle at the rear under the robotic lawnmower. Carry the robotic lawnmower with the blade disc away from the body.

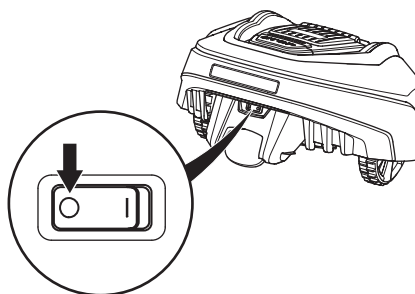

### IMPORTANT INFORMATION

**Do not lift the robotic lawnmower when it is parked in the charging station. This may damage the charging station and/or the robotic lawnmower. Open the cover and instead first pull the robotic lawnmower out of the charging station before lifting it.**

## Maintenance

- Inspect the robotic lawnmower each week and replace any damaged or worn parts.
- Check especially that the blades and blade disc are not damaged. Check also that the blades can pivot freely. Replace all blades and screws at the same time if necessary so that the rotating parts are kept balanced. See 8.6 *Replacing the blades* on page 67.



### IMPORTANT INFORMATION

**Never use a high-pressure washer or even running water to clean the robotic lawnmower. Never use solvents for cleaning.**



---

## 2. PRESENTATION

---

### 2. Presentation

This chapter contains information that is important to be aware of when planning the installation.

Installation of the robotic lawnmower involves four main components:

- A robotic lawnmower that mows the lawn by essentially operating in a random pattern. The robotic lawnmower is powered by a maintenance-free battery.

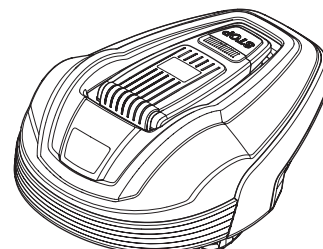

- A charging station, to where the robotic lawnmower returns when the charge level in the battery becomes too low.

The charging station has three functions:

- To send control signals along the boundary wire.
  - To send control signals in the guide wire so that the robotic lawnmower can find the charging station.
  - To charge the robotic lawnmower battery.
- A power supply, which is connected between the charging station and a 100-240V wall socket. The power supply is connected to the wall socket and to the charging station using a 10 m long low voltage cable. The low voltage cable must not be shortened or extended. A 20 meter low voltage cable is available to purchase as an accessory. Contact GARDENA Central Service for more information.

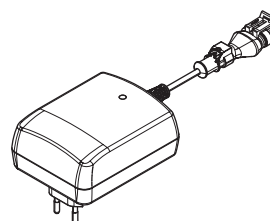
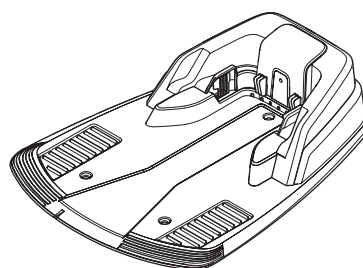

- Loop wire, laid in a loop around the robotic lawnmower's working area. The loop wire is laid around the edges of the lawn and around objects and plants that the robotic lawnmower must not run into. The loop wire is used both as a boundary wire and a guide wire.

The loop wire supplied for the installation is 200 m long (150 m for the GARDENA R38Li, R40Li, R45Li & R50Li). If it is not long enough, more loop wire can be purchased and spliced onto the existing loop wire with an original coupler.

The maximum permitted length for the loop wire is 400 m.

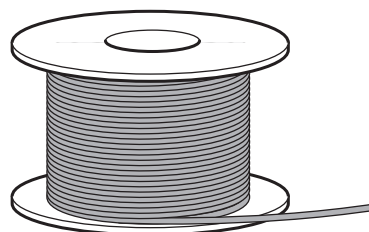

## 2. PRESENTATION

### 2.1 What is what?

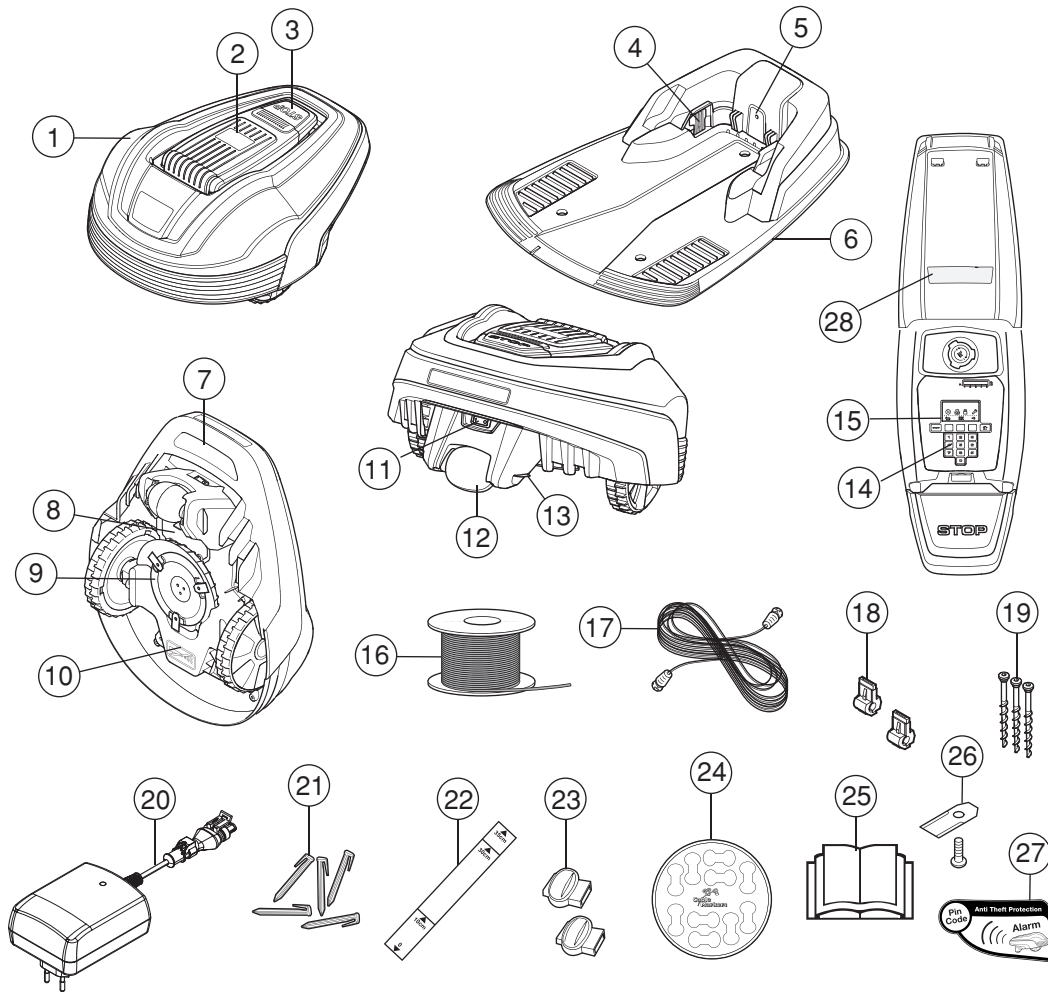

3018-169

The numbers in the illustration represent:

- |  |   |
|--|---|
| 1. Body  | 16. Loop wire for boundary loop and guide wire  |
| 2. Cover to display, keypad and cutting height adjustment                        | 17. Low voltage cable   |
| 3. Stop button/Catch to open the cover   | 18. Connector for connecting the loop wire to the charging station  |
| 4. Contact strips  | 19. Screws for securing the charging station  |
| 5. LED for operation check of the charging station, boundary wire and guide wire | 20. Power supply (the appearance of the power supply may differ depending on market)                                  |
| 6. Charging station  | 21. Staples   |
| 7. Carry handle  | 22. Measurement gauge for help when installing the boundary wire (the measurement gauge is broken loose from the box) |
| 8. Battery cover   | 23. Coupler for the loop wire   |
| 9. Blade disc  | 24. Cable markers   |
| 10. Chassis box with electronics, battery and motors                             | 25. Operator's Manual and Quick Guide   |
| 11. Main switch  | 26. Extra blades  |
| 12. Rear wheel   | 27. Alarm decal   |
| 13. Charging strip   | 28. Rating plate  |
| 14. Keypad   |   |
| 15. Display  |   |

---

## 2. PRESENTATION

---

### 2.2 Package Contents

Your Gardena® robotic mower package contains the following details.

	<b>Gardena® R38Li, R40Li, R45Li, R50Li</b>	<b>Gardena® R70Li, R80Li</b>
Robotic mower	√	√
Charging station	√	√
Power supply	√	√
Loop wire	150 m	200 m
Low voltage cable	√	√
Pegs	200 pcs	400 pcs
Connectors	5 pcs	5 pcs
Charging station screws	3 pcs	3 pcs
Allen key	√	√
Measurement gauge	√	√
Couplers	7 pcs	7 pcs
Operator's Manual and Quick Guide	√	√
Extra blades	3 pcs	3 pcs
Alarm decal	2 pcs	2 pcs

---

## 2. PRESENTATION

---

### 2.3 Function

#### Capacity

The robotic lawnmower is recommended for lawn sizes up to the maximum capacity listed in the technical data section.

How big an area the robotic lawnmower can keep cut depends primarily on the condition of the blades and the type, growth and moisture of the grass. The shape of the garden is also significant. If the garden mainly consists of open lawns, the robotic lawnmower can mow more in one hour than if the garden consists of several small lawns separated by many trees, flower beds and passages.

A fully charged robotic lawnmower mows for 60 to 80 minutes, depending on the age of the battery and how thick the grass is. Then the robotic lawnmower will charge for 50 to 60 minutes. The charging time can vary depending on, among other factors, the ambient temperature.

#### Mowing technique

The robotic lawnmower's mowing system is based on an efficient and energy saving principle. Unlike many standard lawnmowers, the robotic lawnmower cuts the grass instead of knocking it off.

It is recommended to allow the robotic lawnmower to mainly mow in dry weather to obtain the best possible result. The robotic lawnmower can also mow in the rain, however, wet grass easily sticks on the robotic lawnmower and there is a greater risk of slipping on steep slopes.

If there is risk for thunder, the power supply should be disconnected from the power and the boundary wire and the guide wire from the charging station.

The blades must be in good condition to obtain the best mowing result. In order to keep the blades sharp for as long as possible it is important to keep the lawn free from branches, small stones and other objects.

Replace the blades regularly for the best mowing result. It is very easy to replace the blades. See *8.6 Replacing the blades* on page 67.

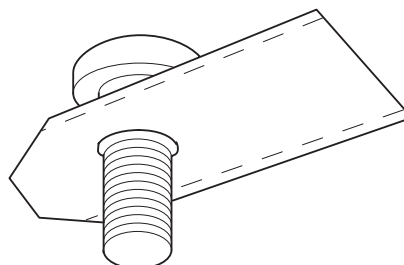
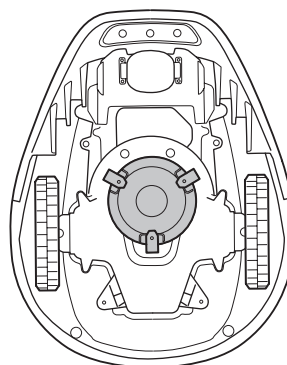



---

## 2. PRESENTATION

---

### Working method

The robotic lawnmower automatically mows the lawn. It continuously alternates between mowing and charging.

The robotic lawnmower starts to search for the charging station when the battery charge becomes too low. The robotic lawnmower does not mow when it is searching for the charging station.

When the robotic lawnmower searches for the charging station, it first searches irregularly for the guide wire. Then it follows the guide wire to the charging station, turns around just in front of the station and backs into it.

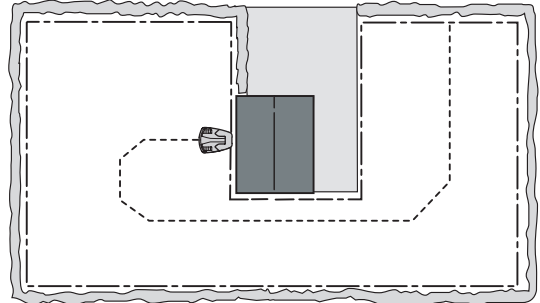

When the battery is fully charged, the robotic lawnmower leaves the charging station in a randomly selected direction within the 90°-270° exit sector.

To ensure an even cut, even in inaccessible parts of the garden, the robotic lawnmower can follow the guide wire out from the charging station to where the guide wire connects to the boundary wire to begin mowing there.

When the robotic lawnmower body hits an obstacle, the robotic lawnmower reverses and selects a new direction.

Two sensors, one on the front and one on the back of the robotic lawnmower, will sense when the robotic lawnmower is approaching the boundary wire. The robotic lawnmower overruns the wire by up to 28 centimetres before it turns back.

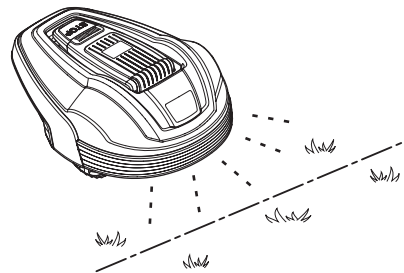
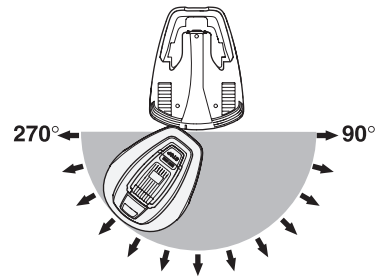

The **STOP** button on the top of the robotic lawnmower is mainly used to stop the robotic lawnmower when it is running. When the **STOP** button is pressed a cover opens, behind which there is a control panel. The **STOP** button remains pressed in until the cover is closed again. This acts as a start inhibitor.

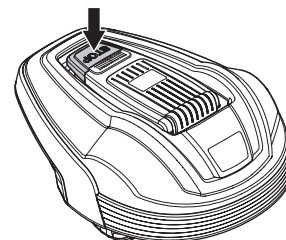

---

## 2. PRESENTATION

---

The control panel on the top of the robotic lawnmower is where you manage all the robotic lawnmower settings. Open the control panel cover by pressing down the **STOP** button.

When the main switch is set to position 1 for the first time, a start-up sequence begins which includes language selection, time format, date format and the four-digit PIN code and setting the time and date. See 3.8 *First start-up and calibration* on page 34.

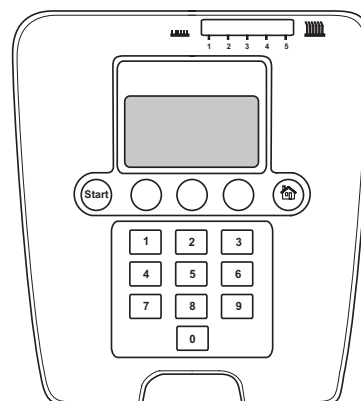

### Movement pattern

The robotic lawnmower's movement pattern is irregular and is determined by the robotic lawnmower itself. A movement pattern is never repeated. With the mowing system the lawn is mown equally without any mowing lines from the robotic lawnmower.

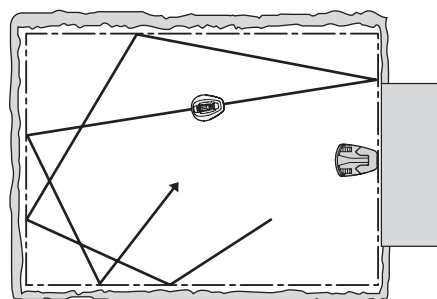

### 2.4 Search method

The robotic lawnmower runs irregularly until it reaches the guide wire. Then the robotic lawnmower follows the guide wire to the charging station.

The guide wire is a wire that is laid from the charging station towards, for instance, a remote part of the working area or through a narrow passage to be then connected with the boundary wire. For more information, see 3.6 *Installation of the guide wire* on page 34.

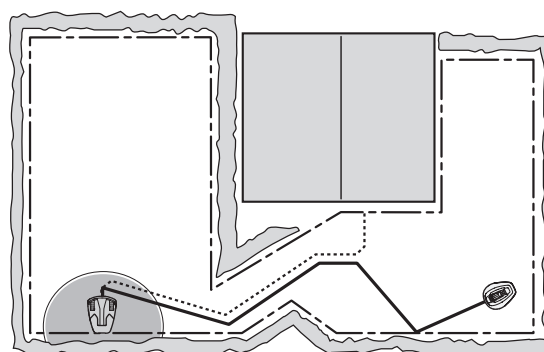

---

## 3. INSTALLATION

---

### 3. Installation

This chapter describes how you install the GARDENA robotic lawnmower. Before starting the installation read the previous chapter 2. *Presentation*.

Read also through this entire chapter before beginning the installation. How the installation is done also affects how well the robotic lawnmower works. It is therefore important to plan the installation carefully.

Planning is simplified if you make a sketch of the working area, including all obstacles. This makes it easier to see the ideal positions for the charging station, the boundary wire and the guide wire. Draw on the sketch where the boundary and guide wires should be routed.

See 7. *Garden examples* on page 59 for installation examples.

Visit also [www.gardena.com](http://www.gardena.com) for further descriptions and tips regarding installation.

#### **Carry out the installation in the following steps:**

- 3.1 Preparations.
- 3.2 Installation of the charging station.
- 3.3 Charging the battery.
- 3.4 Installation of the boundary wire.
- 3.5 Connecting the boundary wire.
- 3.6 Installation of the guide wire
- 3.7 Checking the loop.
- 3.8 First start-up and calibration
- 3.9 Test docking with the charging station

The charging station and boundary and guide wires must be connected to be able to carry out a complete start-up of the robotic lawnmower.

#### **3.1 Preparations**

1. If the lawn in the working area is longer than 10 cm, mow it using a standard lawnmower. Then collect the grass.
2. Read carefully through all the steps before the installation.
3. Check that all parts for the installation are included. The numbers in brackets refer to the component illustration 2.1 *What is what?*.
  - Robotic lawnmower
  - Charging station (6)
  - Loop wire for boundary wire and guide wire (16)
  - Power supply (20)



---

## 3. INSTALLATION

---

- Low voltage cable (17)
- Staples (21)
- Connector for connecting the loop wire to the charging station(18)
- Screws for the charging station (19)
- Measurement gauge (22)
- Couplers for the loop wire (23)

During installation you will also need:

- Hammer/plastic mallet (to simplify putting the staples in the ground)
- Combination pliers for cutting the boundary wire and pressing the connectors together.
- Polygrip (for pressing the couplers together).
- Edge cutter/straight spade if the boundary wire must be buried.

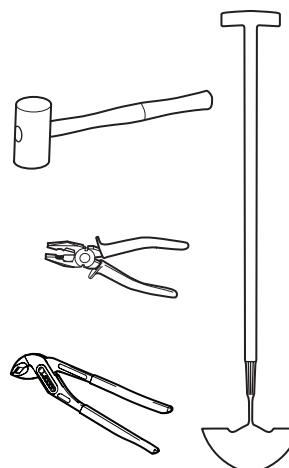

### 3.2 Installation of the charging station

#### Ideal position for the charging station

Take the following aspects into consideration when identifying the best location for the charging station:

- Allow for 3 metres of free space in front of the charging station
- It must be possible to lay at least 1.5 metres of boundary wire straight out to the right and left of the charging station
- It must be close to a wall socket The supplied low voltage cable is 10 metres long. A 20 meter low voltage cable is available to purchase as an accessory. Contact GARDENA Central Service for more information.
- A level surface to place the charging station on
- Protection from water spray for instance from irrigation
- Protection from direct sunlight
- Place in the lower part of a working area that has a major slope
- Possible requirement to keep the charging station out of sight for outsiders

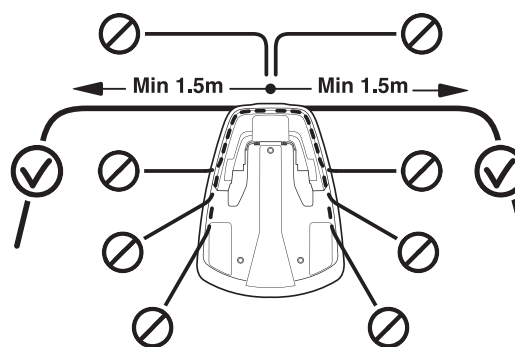

For an example of an ideal position of the charging station, see *7. Garden examples* on page 59.



### 3. INSTALLATION

The charging station must be positioned with a great deal of free space in front of it (at least 3 metres). It should also be centrally placed in the working area to make it easier for the robotic lawnmower to reach all areas in the working area.

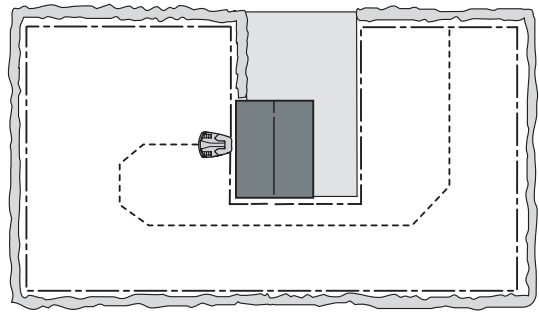

Do not put the charging station in confined spaces in the working area. There must be a straight boundary wire, at least 1.5 metres long, to the right and left of the charging station. The wire must be laid straight out from the rear end of the charging station. Any other locations can mean that the robotic lawnmower enters the charging station sideways and will have difficulty docking.

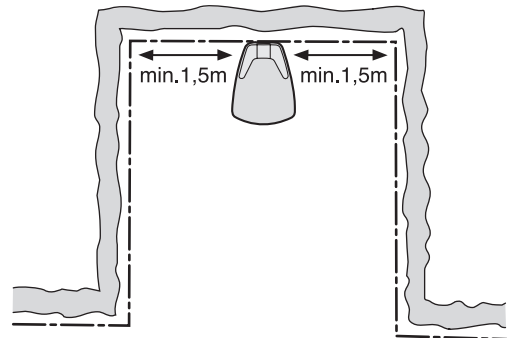

Do not put the charging station in a corner in the working area. There must be a straight boundary wire, at least 1.5 metres long, to the right and left of the charging station.

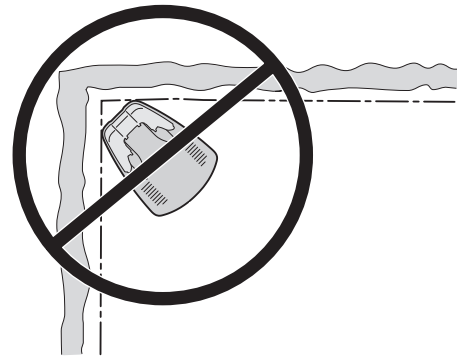

3020-043

The charging station must be positioned on relatively level ground. The front end of the charging station must be a maximum of 3 cm higher than the back end. The front end of the charging station must never be lower than the back end.

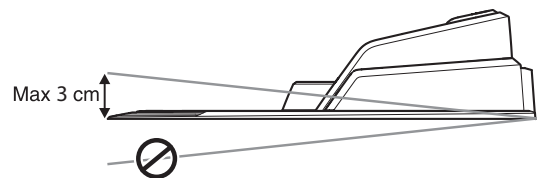

The charging station must not be positioned in a way that can bend its base plate.

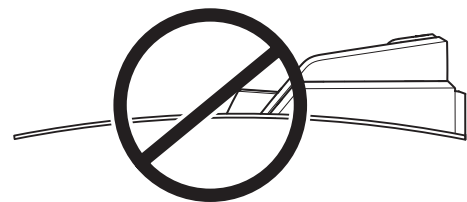

---

## 3. INSTALLATION

---

If the installation is done in a working area with a steep slope (such as around a house on a hill), the charging station should be placed in the area at the bottom of the slope. This makes it easier for the robotic lawnmower to follow the guide wire to the charging station.

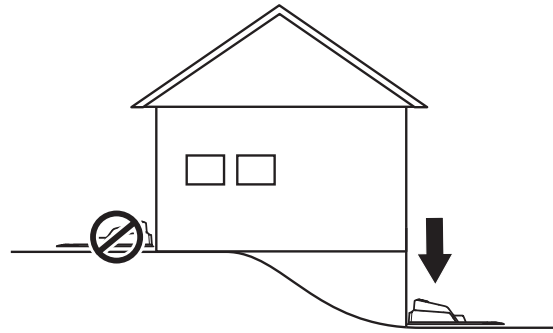

The charging station should not be placed on an island as this limits the laying of the guide wire in an optimal way. If the charging station has to be installed on an island, the guide wire also has to be connected to the island. See the illustration opposite. Read more about islands in chapter 3.4 *Installation of the boundary wire* on page 23.

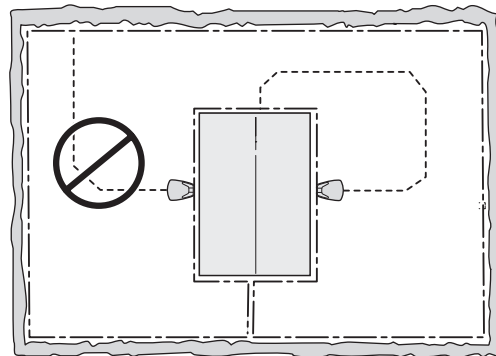

### Connecting the power supply

Take the following into consideration when planning where to place the power supply:

- Close to the charging station
- Protection from rain
- Protection from direct sunlight

If the power supply is connected to an electrical socket outdoors, this must be approved for outdoor use.

The low voltage cable for the power supply is 10 metres long, and may not be shortened or extended.

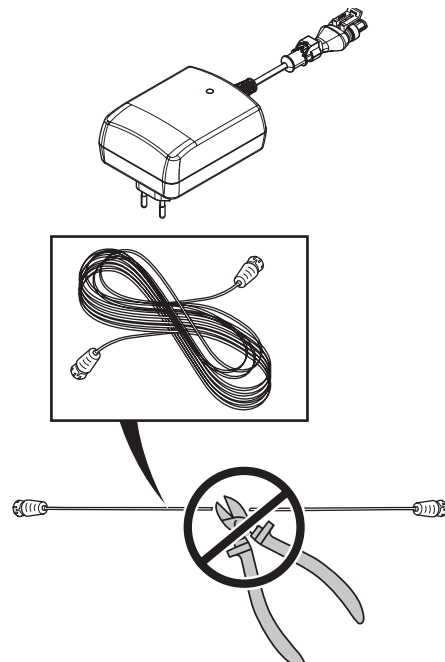

### 3. INSTALLATION

It is possible to let the low voltage cable cross the working area. The low voltage cable must be stapled down or buried, and the cutting height should be such that the blades on the blade disc can never come in contact with the low voltage cable.

Make sure the low voltage cable is laid along the ground and secured with pegs. The cable must lie close to the ground so as not to be cut before the grass roots have grown over it. The low voltage cable must never be stored in a coil or under the charging station's base plate as this can interfere with the signals from the charging station.

The low voltage cable must never be stored in a coil or under the charging station's base plate as this can interfere with the signals from the charging station.

The power supply must be placed where it is well ventilated and is not exposed to direct sunlight. The power supply must be placed under a roof.

It is recommended to use an earth fault-breaker when connecting the power supply to the wall socket.

If the power supply cannot be plugged directly into a wall outlet, do not under any circumstances mount the power supply at a height where there is a risk it can be submerged in water (at least 30 cm from the ground). It is not permitted to place the power supply on the ground.

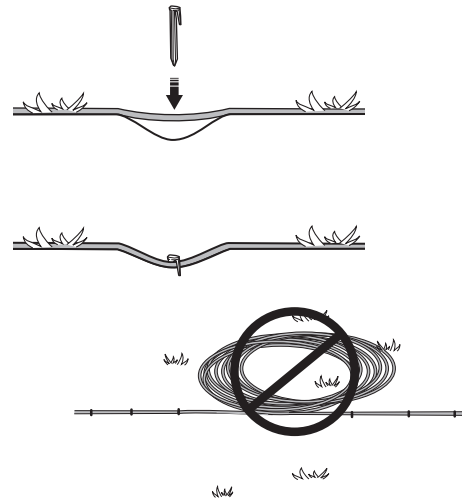

3012-281

#### IMPORTANT INFORMATION

**The low voltage cable must not under any circumstances be shortened or extended.**

#### IMPORTANT INFORMATION

**Place the low voltage cable so that the blades on the blade disc can never come in contact with it.**

#### IMPORTANT INFORMATION

**Use the plug to disconnect the charging station, for instance before cleaning or repairing the loop wire.**

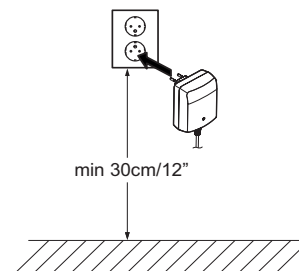

3018-094

## 3. INSTALLATION

### Installation and connecting the charging station

1. Position the charging station in a suitable spot.
2. Connect the low voltage cable to the charging station.
3. Connect the power supply's power cable to a 100-240V wall socket. If the power supply is connected to an electrical socket outdoors, this must be approved for outdoor use.
4. Attach the charging station to the ground using the supplied screws. Ensure the screws are screwed all the way down in the countersink.

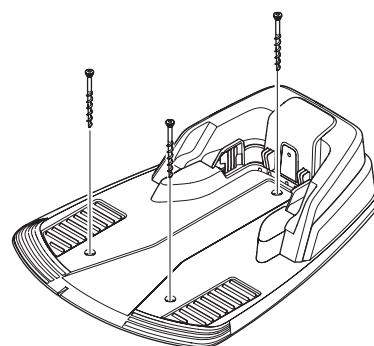
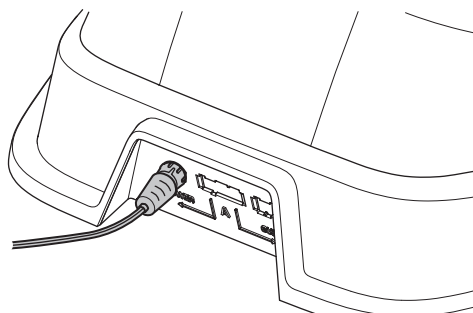

#### IMPORTANT INFORMATION

It is not permitted to make new holes in the base plate. Only the existing holes may be used to secure the base plate to the ground.

#### IMPORTANT INFORMATION

Do not tread or walk on the charging station's base plate.



### 3.3 Charging the battery

As soon as the charging station is connected, it is possible to charge the robotic lawnmower. Set the main switch to position 1.

Place the robotic lawnmower in the charging station to charge the battery while the boundary and guide wires are being laid.

If the battery is flat, it takes around 80 to 100 minutes to fully charge it.

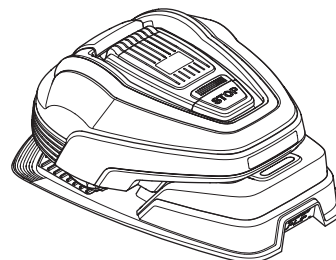

#### IMPORTANT INFORMATION

The robotic lawnmower cannot be used before the installation is complete.



---

## 3. INSTALLATION

---

### 3.4 Installation of the boundary wire

The boundary wire can be installed in one of the following ways:

1. Securing the wire to the ground with staples.

It is preferable to staple down the boundary wire if you want to make adjustments to the boundary wire during the first few weeks of operation. After a few weeks the grass will have grown over the wire making it no longer visible. Use a hammer/plastic mallet and the staples supplied when carrying out the installation.

2. Bury the wire.

It is preferable to bury the boundary wire if you want to dethatch or aerate the lawn. If necessary, both methods can be combined so one part of the boundary wire is stapled down and the remainder is buried. The wire can be buried for instance using an edge cutter or a straight spade. Make sure to lay the boundary wire at least 1 cm and a maximum of 20 cm in the ground.

### Best position for the boundary wire

The boundary wire must be laid so that:

- A loop is formed around the working area for the robotic lawnmower. Only original boundary wire must be used. It is specially designed to resist dampness from the soil that could otherwise easily damage the wires.
- The robotic lawnmower is never more than 15 metres from the wire at any point in the entire working area.
- The total length of the boundary wire does not exceed 400 metres.
- 20 cm of extra wire is available to which the guide wire will be connected later. See 3.6 *Installation of the guide wire* on page 30.

Depending on what the working area is adjacent to, the boundary wire must be laid at different distances from obstacles. The illustration below shows how the boundary wire must be laid around the working area and around obstacles. Use the supplied measurement gauge to obtain the correct distance (see 2.1 *What is what?* on page 12).

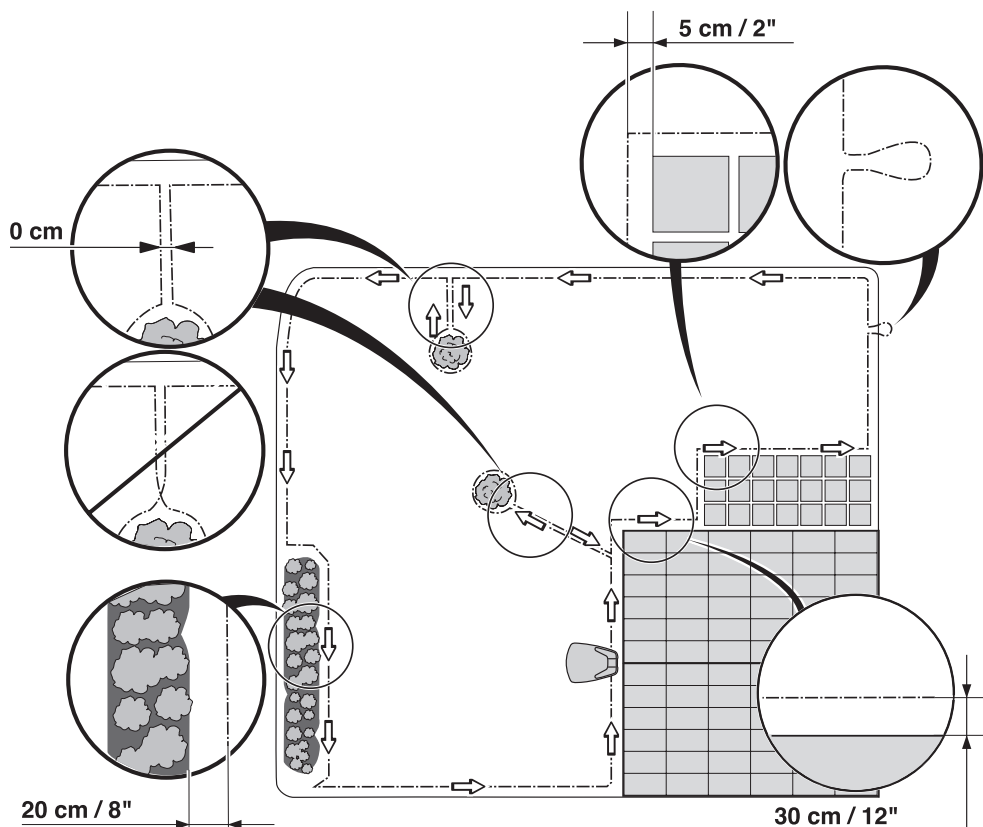

# 3. INSTALLATION

## Working area boundaries

If a high obstacle, for example a wall or fence, borders the working area, the boundary wire should be laid 30 cm from the obstacle. This will prevent the robotic lawnmower from colliding with the obstacle and reduce body wear.

About 20 cm around the fixed obstacle will not be mown.

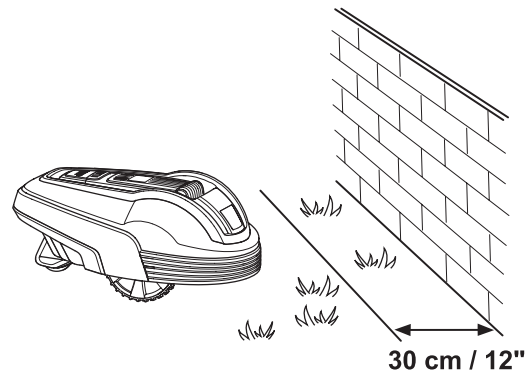

If the working area borders on a small ditch, for example a flower bed or a small elevation, or a low curbstone (3-5 cm), the boundary wire should be laid 20 cm inside the working area. This prevents the wheels from driving into the ditch or up onto the curbstone.

About 12 cm of grass along the ditch/curbstone will not be mown.

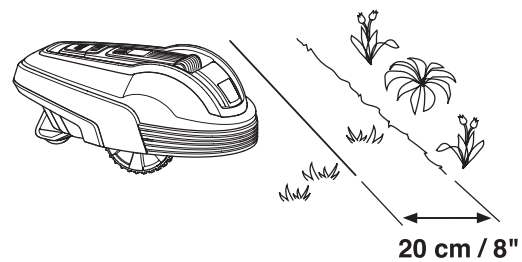

If the working area borders on a paving stone path or similar which is level with the lawn, it is possible to allow the robotic lawnmower to run a little over the path. The boundary wire should then be laid 5 cm from the edge of the path.

All the grass along the side of the paving stone path will be cut.

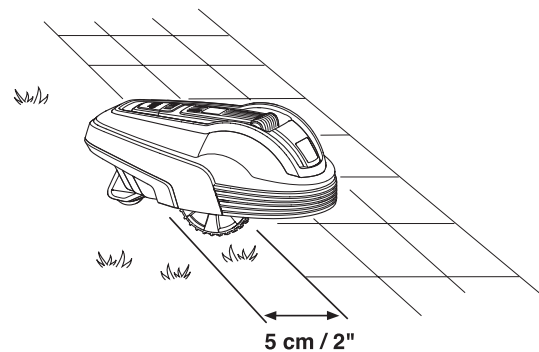

When the working area is divided by a paving stone path which is level with the lawn, it is possible to allow the robotic lawnmower to run over the path. It can be an advantage to lay the boundary wire under the paving stones. The boundary wire can also be laid in the joint between the paving stones. Ensure that the tiles are in level with the lawn to avoid excessive wear on the robotic lawnmower.

Note: The robotic lawnmower must never run over gravel, mulch or similar material which can damage the blades.

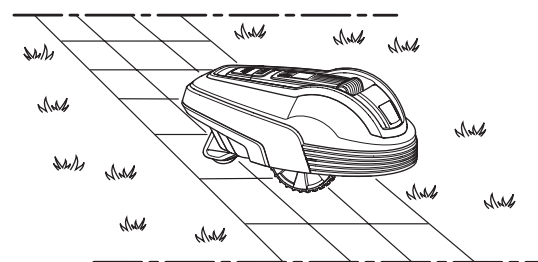

### IMPORTANT INFORMATION

**If the working area is adjacent to water bodies, slopes, precipices or a public road, the boundary wire must be supplemented with an edging or the like. It must then be at least 15 cm in height. This will prevent the robotic lawnmower from ending up outside the working area under any circumstances.**

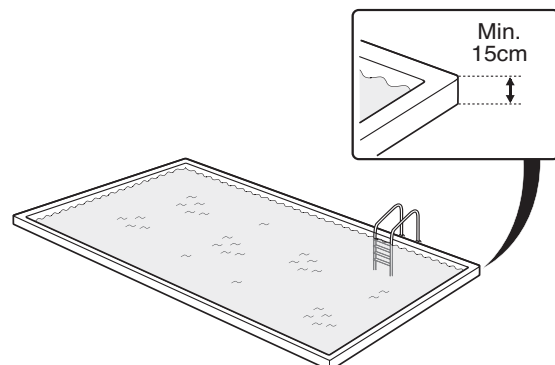

## 3. INSTALLATION

### Boundaries within the working area

Use the boundary wire to demarcate areas inside the working area by creating islands around obstacles which cannot withstand a collision, for example, flowerbeds, bushes and fountains.

Obstacles that can withstand a collision, for example, trees and bushes higher than 15 cm, do not need to be demarcated by the boundary wire. The robotic lawnmower will turn around when it collides with this type of obstacle.

To achieve careful and silent operation, it is recommended to isolate all fixed objects in and around the working area.

Lay the wire up to and around the area to be demarcated, and then return it back along the same route. If staples are used, the wire should be laid under the same staple on the return route. When the boundary wires to and from the island are laid close together, the robotic lawnmower can drive over the wire.

The boundary wire may not be crossed on its way to and from an island.

Obstacles that slope slightly, for example, stones or large trees with raised roots, must be isolated with an island or removed. Otherwise the robotic lawnmower can slide up onto this kind of obstacle causing the blades to be damaged and/or the mower to get stuck.

### Secondary areas

If the working area consists of two areas which the robotic lawnmower has difficulty travelling between, it is recommended to set up a secondary area.

Instances of this are 25% slopes or a passage that is narrower than 60 cm (90 cm for GARDENA R38Li, 40Li, R45Li, R50Li). Lay the boundary wire then around the secondary area so that it forms an island outside of the main area.

The robotic lawnmower must be moved manually between the main and secondary area when the lawn in the secondary area has to be cut. The *MAN* operation mode must be used as the robotic lawnmower cannot travel on its own from the secondary area to the charging station. See *5.1 Operation selection* on page 41. In this mode, the robotic lawnmower will never look for the charging station but will mow until the battery runs out. When the battery is flat, the robotic lawnmower will stop and the *Needs manual charging* message will appear in the display. Then place the robotic lawnmower in the charging station to charge the battery. If the main working area has to be cut after charging, it is appropriate to switch the operation mode to Auto before placing the robotic lawnmower in the charging station.

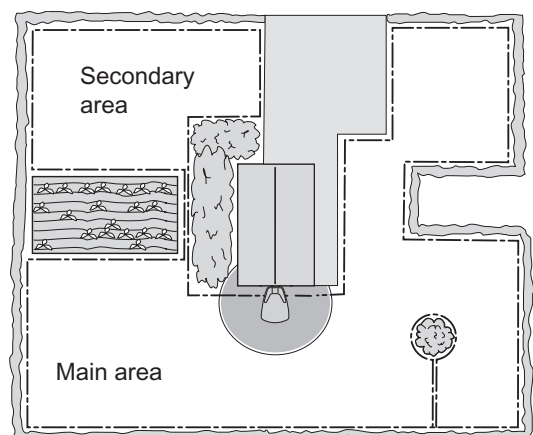
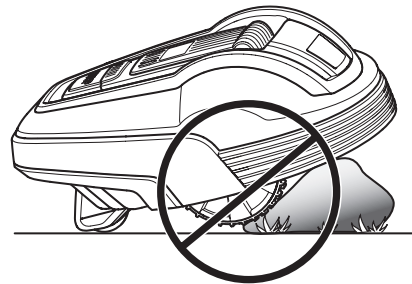
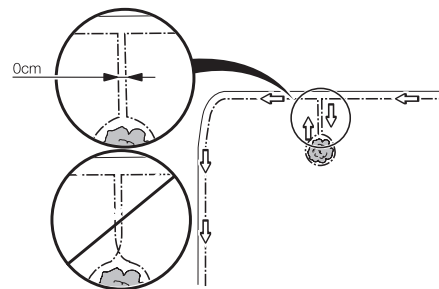
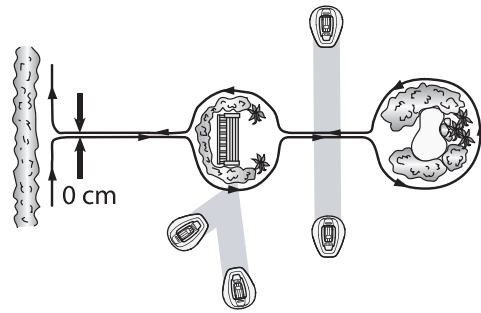

# 3. INSTALLATION

## Passages when mowing

Long and narrow passages and areas narrower than 1.5 - 2 metres should be avoided. When the robotic lawnmower mows, there is a risk that it travels around in the passage or area for a period of time. The lawn will then look flattened.

## Slopes

The boundary wire can be laid across a slope that slants less than 15%.

0-15 %

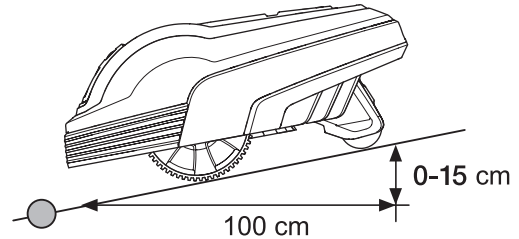

The boundary wire should not be laid across a slope that is steeper than 15%. There is a risk that the robotic lawnmower will find it difficult to turn there. The mower will then stop and the *Outside working area* fault message is displayed. The risk is at its greatest in damp weather conditions, as the wheels can slip on the wet grass

15- %

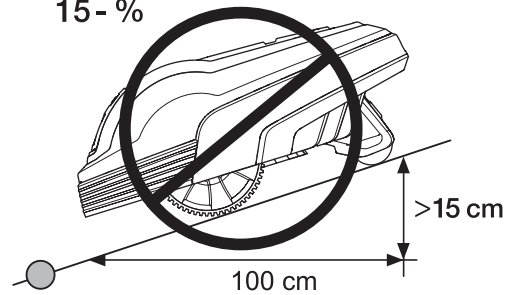

However, the boundary wire can be laid across a slope steeper than 15% if there is an obstacle that the robotic lawnmower is allowed to collide with, for example, a fence or a dense hedge.

The robotic lawnmower can mow lawns that slope up to 25 cm every metre (25%) inside the working area. Areas that slope more must be demarcated by the boundary wire.

When a part of the working area's outer edge slopes more than 15 cm every metre (15%), the boundary wire must be laid about 20 cm in on the flat ground before the beginning of the slope.

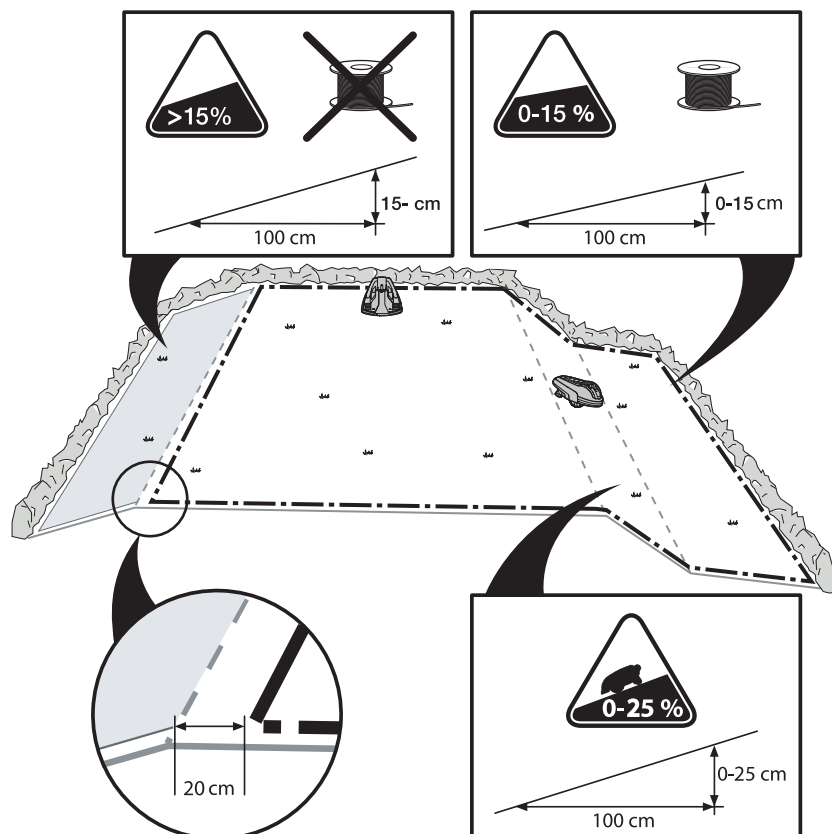



---

## 3. INSTALLATION

---

### Laying the boundary wire

If you intend to staple down the boundary wire:

- Cut the grass very low with a standard lawnmower or a trimmer where the wire is to be laid. It will then be easier to lay the wire close to the ground and the risk of the robotic lawnmower cutting the wire or damaging the insulation of the wire is reduced.
- Make sure to lay the boundary wire close to the ground and secure the pegs close together, approximately 75 cm apart. The cable must lie close to the ground so as not to be cut before the grass roots have grown over it.
- Use a hammer to knock the staples into the ground. Exercise care when knocking in the staples and make sure the wire is not under strain. Avoid sharp bends in the wire.

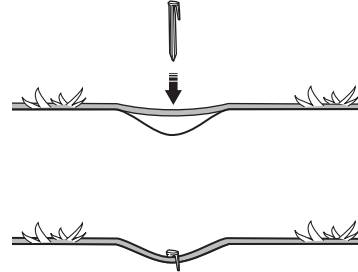

If the boundary wire is to be buried:

- Make sure to lay the boundary wire at least 1 cm and a maximum of 20 cm in the ground. The wire can be buried for instance using an edge cutter or a straight spade.

Use the supplied measurement gauge as a guide when you lay out the boundary wire. This helps you to easily set the correct distance between the boundary wire and the boundary/obstacle. The measurement gauge is broken loose from the box.

#### IMPORTANT INFORMATION

**Extra wire must not be placed in coils outside the boundary wire. This can disrupt the robotic lawnmower.**

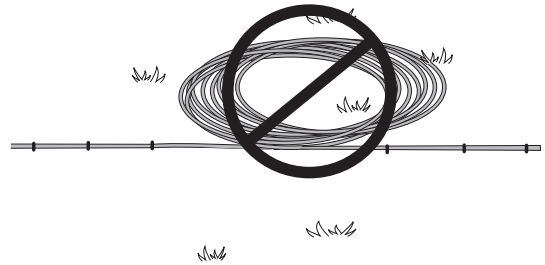

### Loop for connecting the guide wire

To facilitate the connection of the guide wire to the boundary wire, it is recommended to create a loop with about 20 cm of extra boundary wire at the point where the guide wire will later be connected. It is a good idea to plan where the guide wire will be placed before laying out the boundary wire. See [3.6 Installation of the guide wire](#) on page 30.

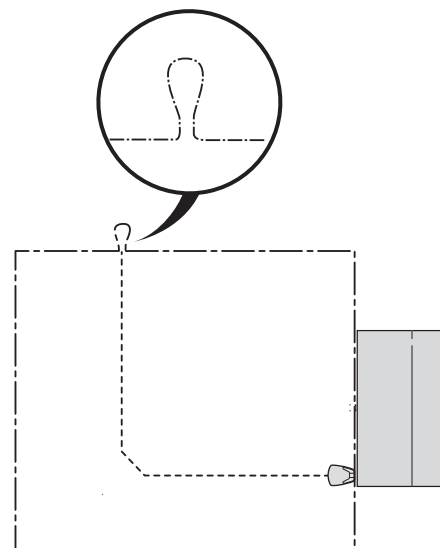

---

## 3. INSTALLATION

---

### Laying the boundary wire in towards the charging station

The boundary wire must be laid in line with the rear end of the charging station and at least 1.5 metres straight out to the right and left of the station. See the illustration. If the boundary wire is laid in any other way, the robotic lawnmower may find it hard to find the charging station.

The straight route to the right of the charging station, in some cases needs to be increased depending on how the boundary wire is placed in the installation.

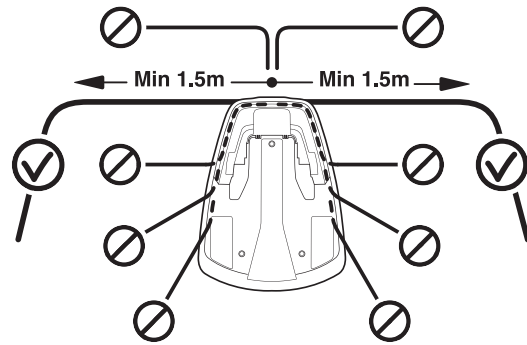

### Splicing the boundary wire

Use an original coupler if the boundary wire is not long enough and needs to be spliced. It is waterproof and gives a reliable electrical connection.

Insert both wire ends in the coupler. Check that the wires are fully inserted into the coupler so that the ends are visible through the transparent area on the other side of the coupler. Now press down the button on top of the coupler fully. Use a polygrip to completely press down the button on the coupler.

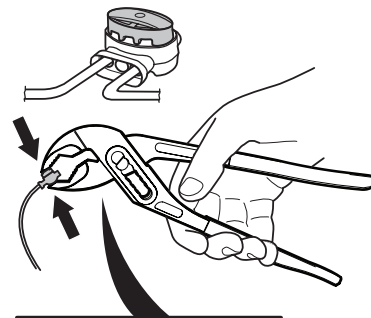

#### IMPORTANT INFORMATION

**Twinned cables, or a screw terminal block that is insulated with insulation tape are not satisfactory splices. Soil moisture will cause the leads to oxidise and after a while result in a broken circuit.**

## 3. INSTALLATION

### 3.5 Connecting the boundary wire

Connect the boundary wire to the charging station:

#### IMPORTANT INFORMATION

The boundary wire must not be crossed when connecting it to the charging station. The right hand wire end must be connected to the right hand pin on the charging station and the left hand wire end to the left pin.

1. Place the wire ends in the connector:
  - Open the connector.
  - Place the wire in the connector grip.
2. Press the connectors together using a pair of pliers. Press until you hear a click.

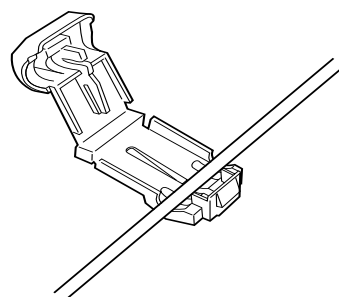

3. Cut off any excess boundary wire 1 or 2 centimetres above each connector.

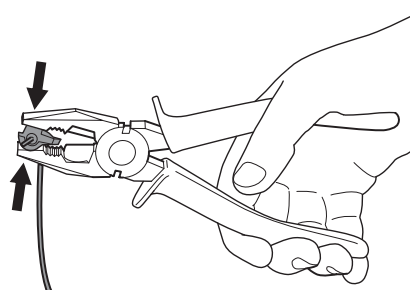

4. Press the connector onto the metal pin, Press the connector onto the contact pin, marked AL (left) and AR (right), on the charging station.  
Carefully check that the connector is properly fitted.

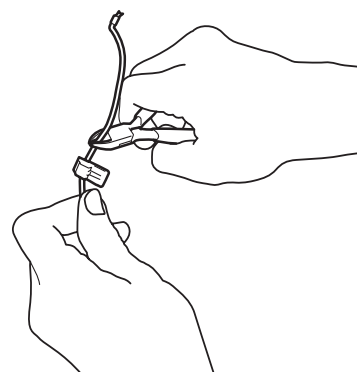

#### IMPORTANT INFORMATION

The right hand connector must be connected to the right hand metal pin on the charging station and the left hand wire end to the left connector.

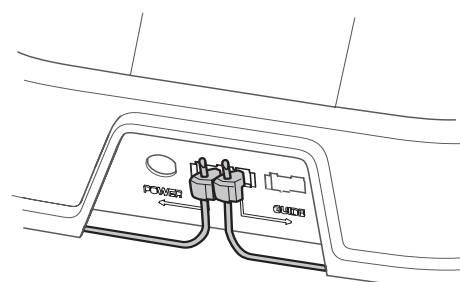

## 3. INSTALLATION

### 3.6 Installation of the guide wire

The guide wire is a wire that is laid from the charging station towards, for instance, a remote part of the working area or through a narrow passage to be then connected with the boundary wire. The same cable roll is used for both the boundary and guide wires.

The guide wire is used by the robotic lawnmower to find its way back to the charging station but also to guide the robotic lawnmower to remote areas of the garden.

To ensure an even cut over the entire lawn, the robotic lawnmower can follow the guide wire from the charging station to the guide wire connection in the boundary wire and start mowing there. Depending on the garden layout, one should adjust how often the robotic lawnmower is to follow the guide wire from the charging station. See 6.6 *Settings* on page 55.

The robotic lawnmower runs at varying distances from the guide wire to reduce the risk of tracks forming when the robotic lawnmower follows the guide wire to and from the charging station. The area beside the wire which the robotic lawnmower then uses is called the Corridor.

The robotic lawnmower always runs to the left of the guide wire as seen facing the charging station. Thus the corridor is to the left of the guide wire. The corridor is 50 cm wide. When installing, it is therefore important to have at least 75 cm free space to the left of the guide wire and at least 25 cm free space to the right of the guide wire, as seen facing the charging station.

It is not allowed to lay the guide wire closer than 30 cm from the boundary wire.

The guide wire, as the boundary wire, can be stapled to or buried in the ground.

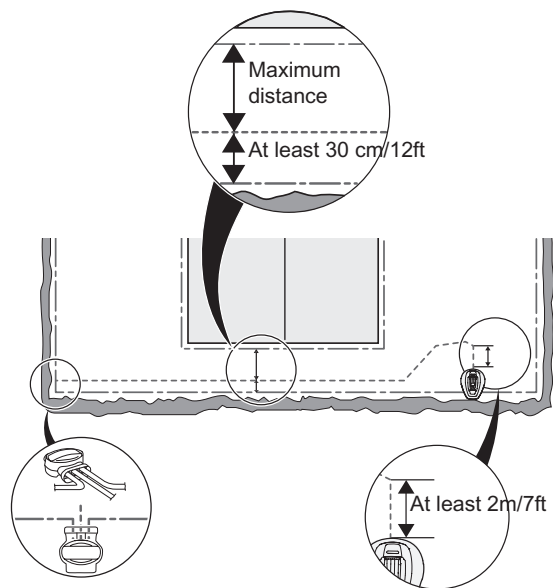
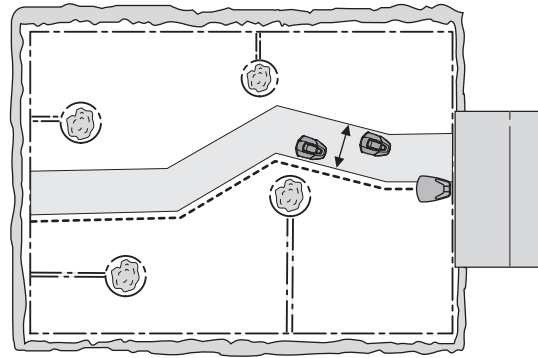

#### IMPORTANT INFORMATION

**Make sure that there is always at least 75 cm of free space to the left of the guide wire as seen facing the charging station.**

## 3. INSTALLATION

### Laying and connecting the guide wire

1. Run the wire through the slot in the bottom of the charger plate.

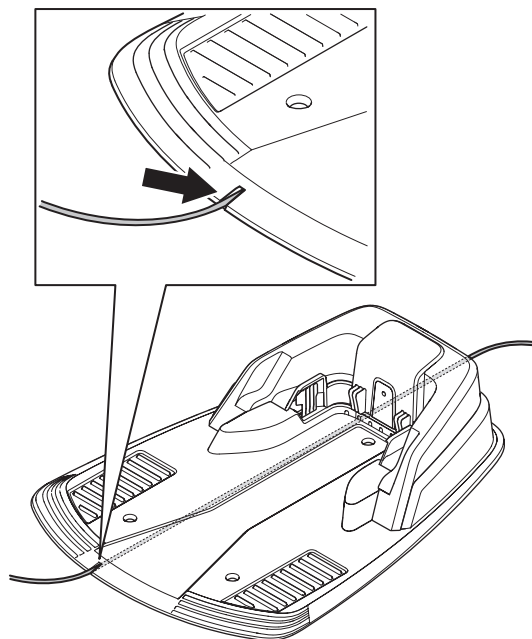

2. Fit the connector to the guide wire in the same way as for the boundary wire described in *3.5 Connecting the boundary wire* on page 29. Connect it to the contact pin on the charging station that is labelled Guide .

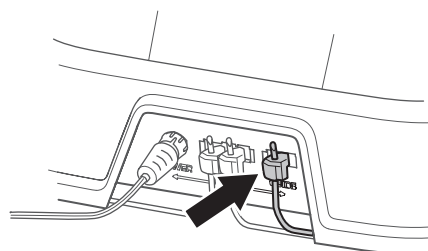

3. Run the wire at least 2 metres straight out from the front edge of the plate.

If the guide wire must be laid in a passage:

The robotic lawnmower follows the guide wire on the same side of the wire to and from the charging station. This means that the guide wire is to the right of the robotic lawnmower when the mower travels to the charging station while it is to the left of the mower when the mower travels away from the charging station.

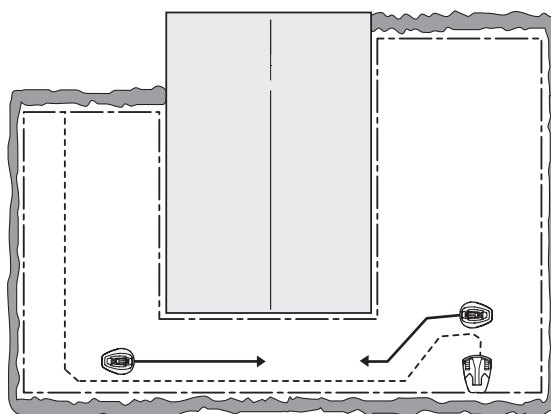

## 3. INSTALLATION

- In the passage, the guide wire must therefore be placed so that the robotic lawnmower has as much space to run in as possible. The distance between the boundary wire and the guide wire must however be at least 30 cm.

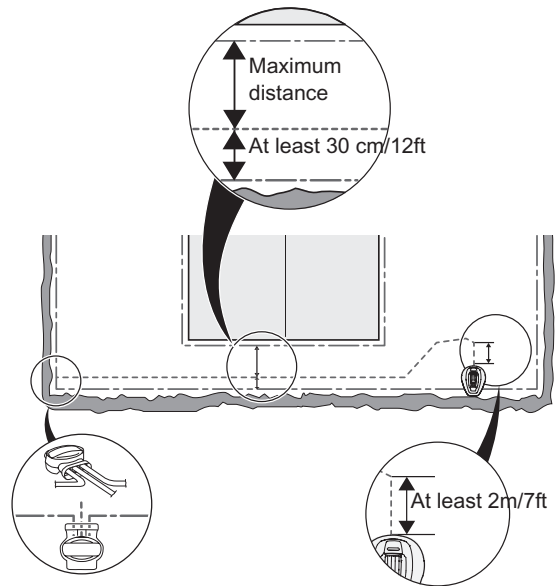

If the guide wire has to be installed on a steep slope, it is an advantage to lay the wire at an angle to the slope. This makes it easier for the robotic lawnmower to follow the guide wire on the slope.

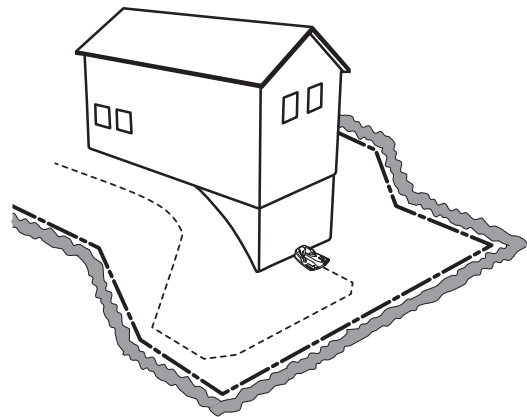

Avoid laying the wire at sharp angles. This can make it difficult for the robotic lawnmower to follow the guide wire.

4. Run the guide wire up to the point on the boundary wire where a loop to facilitate the connection of the guide wire was previously added.
5. Cut the loop on the boundary wire using for instance a pair of wire cutters.

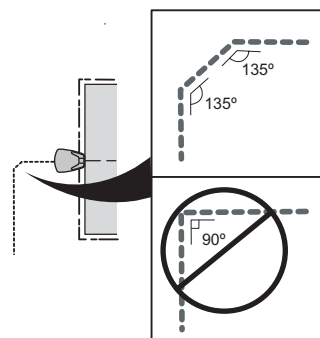



## 3. INSTALLATION

6. Connect the guide wire to the boundary wire using a coupler:

Insert the boundary wire in each of the holes in the coupler. Insert the guide wire in the centre hole in the coupler. Check that the wires are fully inserted into the coupler so that the ends are visible through the transparent area on the other side of the coupler.

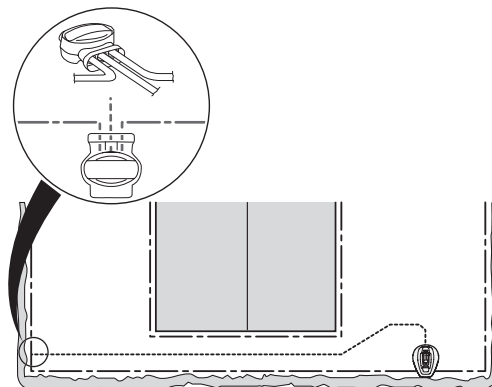

Use a polygrip to completely press down the button on the coupler.

It does not matter which holes are used to connect each wire.

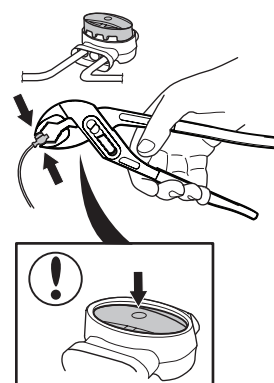

7. Staple down/bury the connector in the lawn.

### IMPORTANT INFORMATION

The guide wire may not cross the boundary wire, for instance a boundary wire that is laid out to an island.

### IMPORTANT INFORMATION

Test that the guide wire works using the *Calibrate guide* function before using the robotic lawnmower. See 3.8 *First start-up and calibration* on page 34.

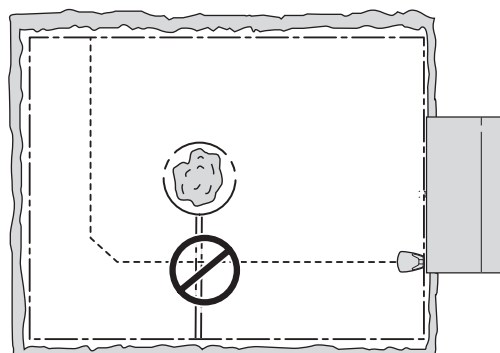

---

## 3. INSTALLATION

---

### 3.7 Checking the loop

Check the loop signal by inspecting the indicator lamp on the charging station.

See 9.2 *Indicator lamp in the charging station* on page 73 if the lamp does not indicate a solid green light.

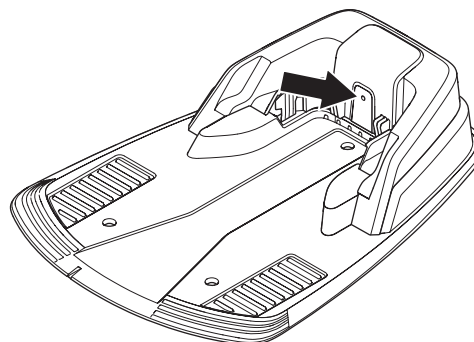

### 3.8 First start-up and calibration

Before the robotic lawnmower is operated, a start-up sequence in the robotic lawnmower's menu must be carried out as well as an automatic calibration of the guide signal. The calibration is also a good test to see that the installation of the guide wire has been done in such a way that the robotic lawnmower can easily follow the guide wire from the charging station.

1. Open the control panel cover by pressing the **STOP** button.
2. Set the main switch to position 1.

A start-up sequence begins when the robotic lawnmower is started for the first time. The following is requested:

- Language
- Country
- Time format
- Current time
- Date format
- Date
- Four digit PIN code. All combinations except 0000 are permitted.

#### IMPORTANT INFORMATION

Use *Memo* on page 4 to make a note of the PIN code.

3. Place the robotic lawnmower in the charging station as requested in the display. Press the START button and close the cover. The robotic lawnmower will now start the guide calibration, by leaving the charging station and following the guide wire to the point where the guide wire is connected to the boundary wire to begin mowing there. Check that the robotic lawnmower can follow the guide wire all the way.

If it cannot, this may be due to an incorrectly installed guide wire. In this case, check that the installation is performed as described in 3.6 *Installation of the guide wire* on page 30. Then carry out a new calibration. See 6.6 *Settings* on page 55.

In the case of the R70Li/R80Li, it is also possible to reduce the guide width for the robotic lawnmower to follow the guide wire through very narrow passages. See 6.4 *Installation, R70Li, R80Li* on page 49. Use the Test out function to carry out a new calibration in the R70Li/R80Li. See 6.4 *Installation, R70Li, R80Li* on page 49.

---

## 3. INSTALLATION

---

### 3.9 Test docking with the charging station

Before using the robotic lawnmower, check that the robotic lawnmower can follow the guide wire all the way to the charging station and easily docks with the charging station. Perform the test below.

1. Open the control panel cover by pressing the **STOP** button.
2. Place the robotic lawnmower close to the point where the guide wire is connected to the boundary wire. Place the robotic lawnmower about 2 metres from the guide wire, facing the guide wire.
3. Select *Home* mode by pressing the house symbol key and pressing *OK* when the cursor is at *Home*. Press **Start** and close the cover.
4. Check that the robotic lawnmower follows the guide wire all the way to the charging station and that it docks with the charging station. The test is approved only if the robotic lawnmower is able to follow the guide wire the entire distance to the charging station and docks at the first attempt. If the robotic lawnmower is unable to dock on the first attempt, it will automatically try again. The installation is not approved if the robotic lawnmower needs two or more attempts to dock with the charging station. In this case, check that the charging station, the boundary wire and the guide wire are installed in accordance with the instructions in Chapters 3.2, 3.4 and 3.6.
5. The robotic lawnmower will stay in the charging station until *Auto* or *Man* mode is selected. See *5.1 Operation selection* on page 41.

The guide system must first be calibrated if the above test is to provide a satisfactory result. See *3.8 First start-up and calibration* on page 34.

---

## 4. USE

---

### 4. Use

#### 4.1 Charging a flat battery

When the GARDENA robotic lawnmower is new or has been stored for a long period, the battery will be flat and needs to be charged before starting. Charging takes approximately 80 to 100 minutes.

1. Set the main switch to position 1.
2. Park the robotic lawnmower in the charging station. Open the cover and slide the robotic lawnmower in as far as possible to ensure proper contact between the robotic lawnmower and the charging station.
3. The display shows a message that charging is in progress.

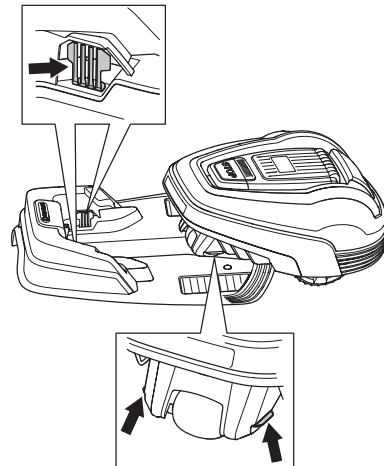
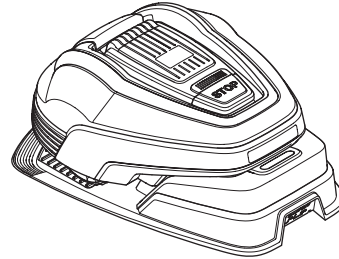

#### WARNING

Read the safety instructions carefully before you start your robotic lawnmower.



#### WARNING

Keep your hands and feet away from the rotating blades. Never put your hands or feet close to or under the body when the motor is running.



#### WARNING

Never use the robotic lawnmower when persons, especially children, or pets, are in the cutting area.

## 4. USE

### 4.2 Using the timer

Use the timer function (see 6.3 *Timer* on page 46.) to avoid a downtrodden lawn. When setting the timer, calculate that the robotic lawnmower mows about the listed amount of the number of square meters per hour and day listed in table Work capacity.

#### Example

If the working area is 360 m<sup>2</sup> in size, R70Li must operate for 8 hours a day. The times are approximate and depend for instance on grass quality, blade sharpness and battery age.

Model	Work capacity
GARDENA R38Li	About 32 m <sup>2</sup> per hour and day
GARDENA R40Li	About 33 m <sup>2</sup> per hour and day
GARDENA R45Li	About 38 m <sup>2</sup> per hour and day
GARDENA R50Li	About 42 m <sup>2</sup> per hour and day
GARDENA R70Li	About 44 m <sup>2</sup> per hour and day
GARDENA R80Li	About 50 m <sup>2</sup> per hour and day

#### IMPORTANT INFORMATION

**Use the timer to avoid mowing when there are usually children, pets and anything else that could be damaged by the rotating blades on the lawn.**

The factory setting for the timer is 07:00-23:00 (07:00-22:00 for the GARDENA R38Li,R40Li,R45Li,R50Li) and it allows mowing every day of the week. This setting is suitable for the listed maximum working area.

If the size of the working area allows it, the quality of the grass can be further improved if it is cut every other day instead of a few hours every day. In addition, the grass benefits from resting completely during at least a three-day period once a month.

Model	Standby time
GARDENA R38Li	At least 12 hours per day
GARDENA R40Li	At least 12 hours per day
GARDENA R45Li	At least 12 hours per day
GARDENA R50Li	At least 12 hours per day
GARDENA R70Li	At least 8 hours per day
GARDENA R80Li	At least 8 hours per day

### Standby

The robotic lawnmower has an inbuilt standby period according to the Standby time table. The standby period provides for instance a good opportunity to water or play games on the lawn.

#### Example 1

The times used in this example are applicable to GARDENA R40Li, but the principle is the same for the other models.

Work period 1: 07:00 - 22:00

Work days: All days

The factory setting ensures that the robotic lawnmower begins cutting the lawn at 07.00. The mower is parked in the charging station from 19.00 and rests until it starts cutting again at 07.00.

If the timer setting is divided into two work periods, the standby period can be divided into a number of periods. The minimum standby period time must however be according to the Standby time table.

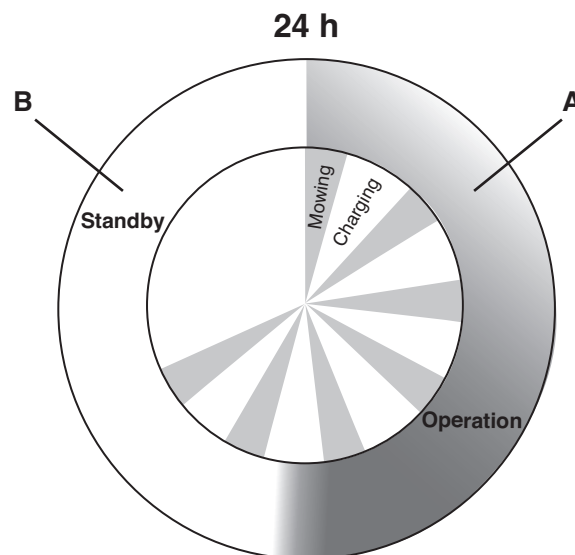

#### R40Li

Operation	<b>A = Max 12 h</b>
Charging/Standby	<b>B = Min 12 h</b>

## 4. USE

### Example 2

The times used in this example are applicable to GARDENA R40Li, but the principle is the same for the other models.

Work period 1: 06:00 - 16:00

Work period 2: 20:00 - 23:00

Work days: All days

The robotic lawnmower will operate between 06:00 and 16:00. It will begin again at 20:00 but stop running at 22:00 to rest until it starts again at 06:00.

The times are approximate and depend for instance on grass quality, blade sharpness and battery age.

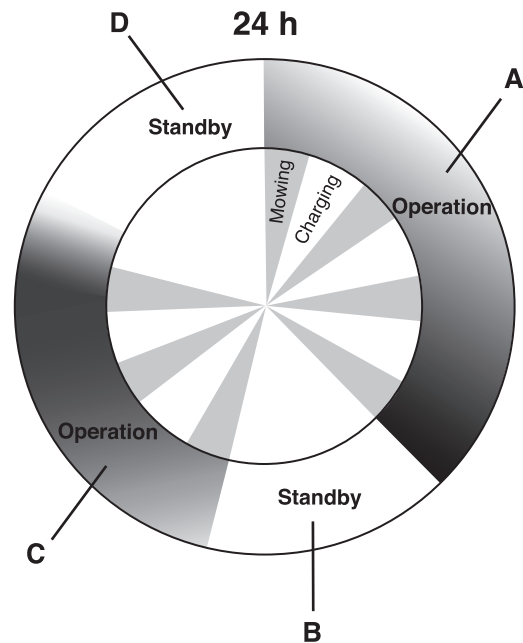

### 4.3 Starting

1. Set the main switch to position 1.
2. Press the **STOP** button to open the control panel cover.
3. Enter the PIN code.
4. Push the **START** button.
5. Shut the cover within 10 seconds.

If the robotic lawnmower is parked in the charging station, it will only leave the charging station when the battery is fully charged and if the timer is set to allow the mower to operate.

Before the blade disc starts, 5 beeps are heard for 2 seconds.

### 4.4 Stopping

1. Press the **STOP** button.

The robotic lawnmower stops, the blade motor stops and the control panel cover opens.

#### R40Li

Operation	<b>A + C = Max 12 h</b>
Charging/Standby	<b>B + D = Min 12 h</b>

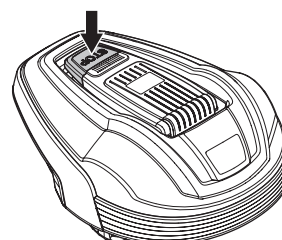
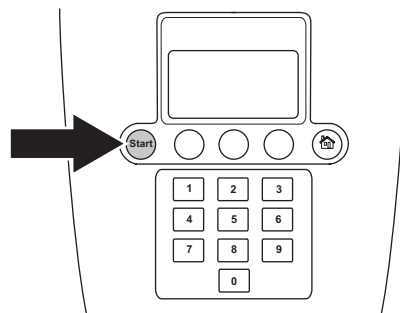



---

## 4. USE

---

### 4.5 Switching off

1. Press the **STOP** button.
2. Set the main switch in position 0.

Always switch the robotic lawnmower off using the main switch if it requires maintenance or if the robotic lawnmower must be moved outside the working area.

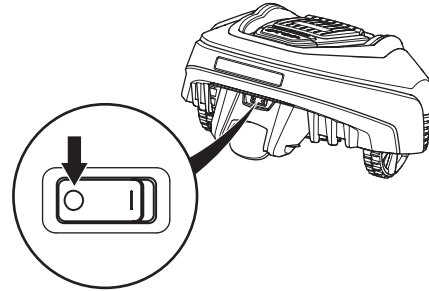

### 4.6 Adjusting the cutting height

The cutting height can be varied from MIN (2 cm) to MAX (5 cm).

To adjust the cutting height:

1. Press the **STOP** button to stop the robotic lawnmower and open the cover.
2. Turn the height adjustment knob to the required position. The selected position is indicated by the orange column that can be seen by the knob through the window.
  - Turn anti-clockwise to raise the cutting height.
  - Turn clockwise to lower the cutting height.

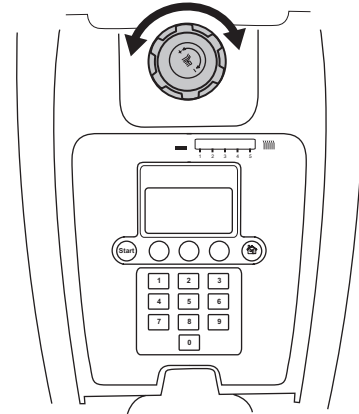

#### IMPORTANT INFORMATION

During the first week after a new installation, the cutting height must be set to **MAX** to avoid damaging the loop wire. After this, the cutting height can be lowered step by step every second week until the desired cutting height has been reached.

## 5. CONTROL PANEL

### 5. Control panel

All forms of commands and settings for the GARDENA robotic lawnmower are made via the control panel. All functions are accessed via a number of menus.

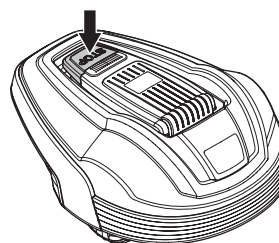

The control panel consists of a display and a keypad. All information is shown on the display and all input is done using the buttons.

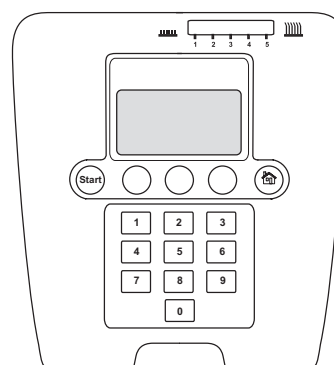

When the stop button has been pressed and the cover is opened, the operation window appears showing the time, selected operating mode, number of mowing hours, battery status and timer setting.

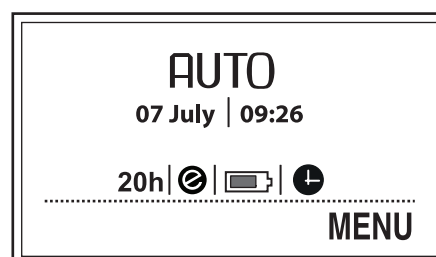

- The clock shows the current time.
- Date shows the current day.
- The number of operating hours indicates the number of hours since the day of manufacture that the robotic lawnmower has been in operation. The time that the robotic lawnmower has spent mowing or looking for the charging station is counted as operating time.
- *AUTO*, *MAN* or *HOME* show which mode of operation is selected. See chapter 5.1 *Operation selection*
- The battery status shows the remaining battery charge.
- ECO is displayed if the robotic lawnmower is set in ECO mode.
- The clock symbol indicates when the timer settings are set. The clock symbol is black when the robotic lawnmower is not allowed to mow due to a timer setting and it is white when the mower is allowed to mow.
- The *MENU* text illustrates that the main menu can be reached by pressing the multi-choice button that is located under the text.

The keypad consists of four groups of buttons: operation selection button, multi-choice buttons, numbers and start button.

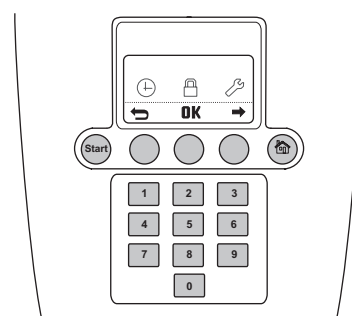

---

## 5. CONTROL PANEL

---

### 5.1 Operation selection

The operation selection button is symbolised by a house. When the button has been pressed, the selected operation mode is shown in the display. By consecutively pressing the button many times, one can choose between three different operation modes.

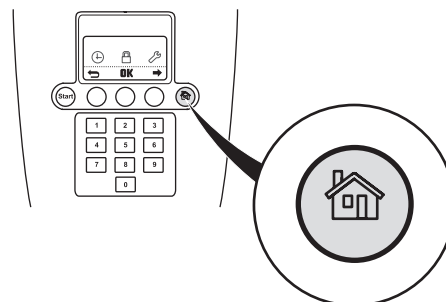

1. **HOME:**

Sends the robotic lawnmower to the charging station. It remains here until another operation mode is selected. The text *Home* is shown in the operation window. When the battery is fully charged, the robotic lawnmower will remain parked in the charging station. The robotic lawnmower will first leave the charging station and begin mowing again when the operation selection is altered to AUTO.

The Home setting is also used after a new installation or when changes are made to an existing installation to test if the robotic lawnmower can follow the guide wire and dock with the charging station. See *3.9 Test docking with the charging station* on page 35.

2. **AUTO:**

The standard, automatic operation mode where the robotic lawnmower mows and charges automatically.

3. **MAN:**

When mowing secondary areas (see *3.4 Installation of the boundary wire* on page 23), the *MAN* setting must be used.

If *MAN* is selected and the robotic lawnmower starts when it is out on the lawn, it will mow until the battery runs out. It will then stop and the *Needs manual charging* message will appear. The robotic lawnmower must then be moved manually to the charging station and then started manually after charging.

If the robotic lawnmower charges in the *MAN* mode, it will fully charge, move about 20 cm out of the charging station and then stop. This indicates that it is charged and ready to start mowing.

If the main working area has to be cut after charging, it is appropriate to switch the operation mode to Auto before placing the robotic lawnmower in the charging station.

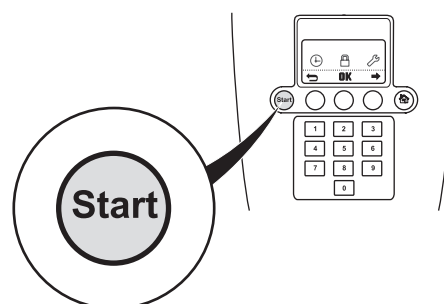

#### IMPORTANT INFORMATION

**Always press the START button before closing the cover to start the robotic lawnmower. If the START button is not pressed, a message beep is heard and the robotic lawnmower will not start.**

---

## 5. CONTROL PANEL

---

### 5.2 Multi-choice buttons

The three multi-choice buttons offer various functions, among others depending on where in the menu structure you are. The button function is shown at the very bottom of the display.

Example: If you are in the main menu, the left button can be used to go back, the middle button confirms any selections and the right button helps you to scroll the menu.

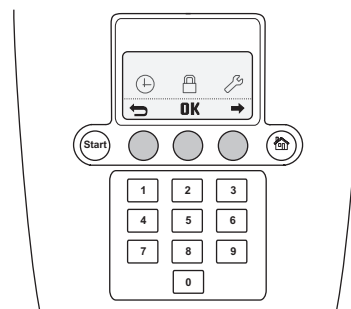

### 5.3 Numbers

The number keys are used for instance to enter the PIN code or time settings.

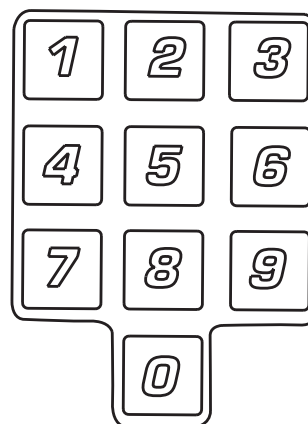

### 5.4 Main switch

Set the main switch in 1 position to start the robotic lawnmower.

Set the main switch in the 0 position when the robotic lawnmower is not in use or work is being carried out on the blade disc.

When the main switch is set in the 0 position the motors on the robotic lawnmower cannot start.

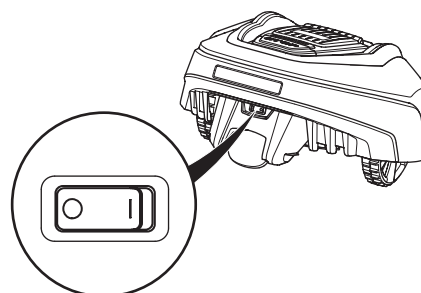

---

## 6. MENU FUNCTIONS

---

### 6. Menu functions

#### 6.1 Main menu

The main menu for the GARDENA R38Li, R40Li, R45Li, R50Li offers three options:

- *Timer*
- *Security*
- *Settings*

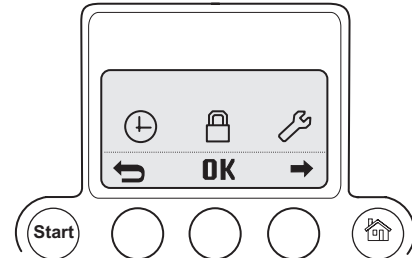

The main menu for the GARDENA R70Li /R80Li offers four options:

- *Timer*
- *Installation*
- *Security*
- *Settings*

There are a number of submenus under each option. You can access all the functions to set the robotic lawnmower settings via these.

#### Browse between menus

Browse the main menu and submenu using the multi-choice buttons. Enter values and times using the number keys and confirm each selection with the multi-choice button marked OK. Press the multi-choice button with the **return arrow** to go up a step in the menu or keep the operation selection button pressed in for 2 seconds to go directly back to the main menu.

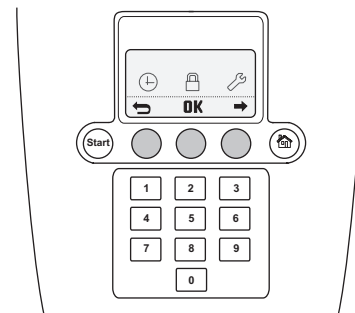

#### Submenus

Certain submenus contain options that are ticked off to the left. This means that these options are selected. Check or uncheck the box by pressing OK.

In some of the submenus there is information to the right of specific rows. This information indicates which selection has been made for the function.

# 6. MENU FUNCTIONS

## 6.2 Menu structure

GARDENA R38Li, R40Li, R45Li, R50Li

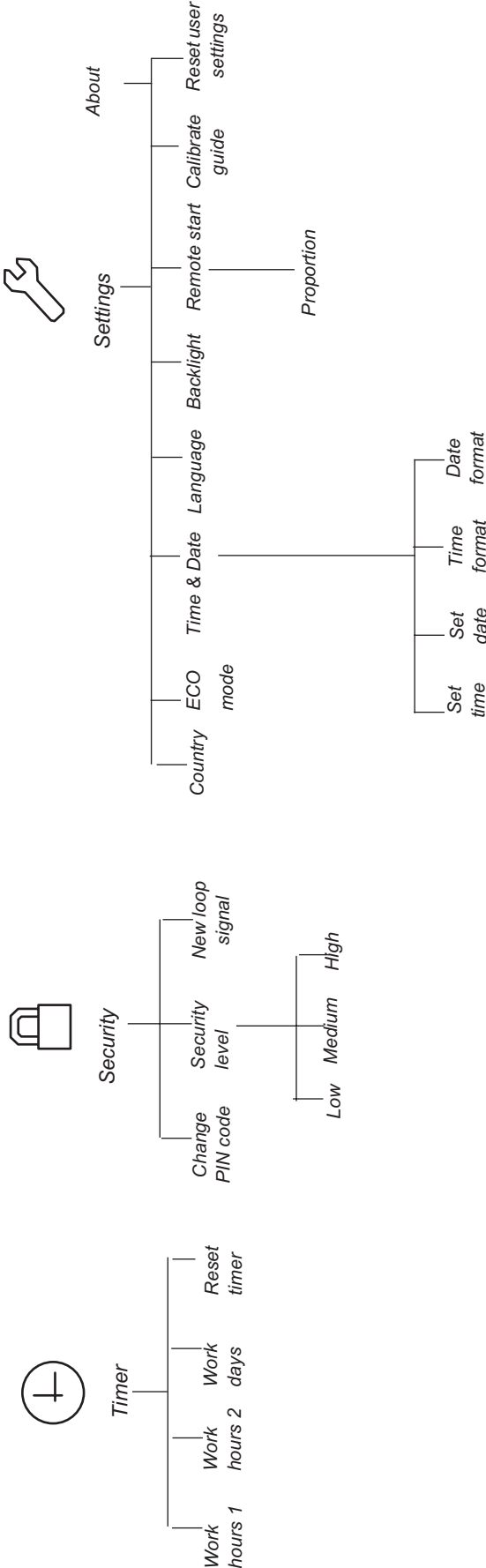



# 6. MENU FUNCTIONS

GARDENA R70Li, R80Li

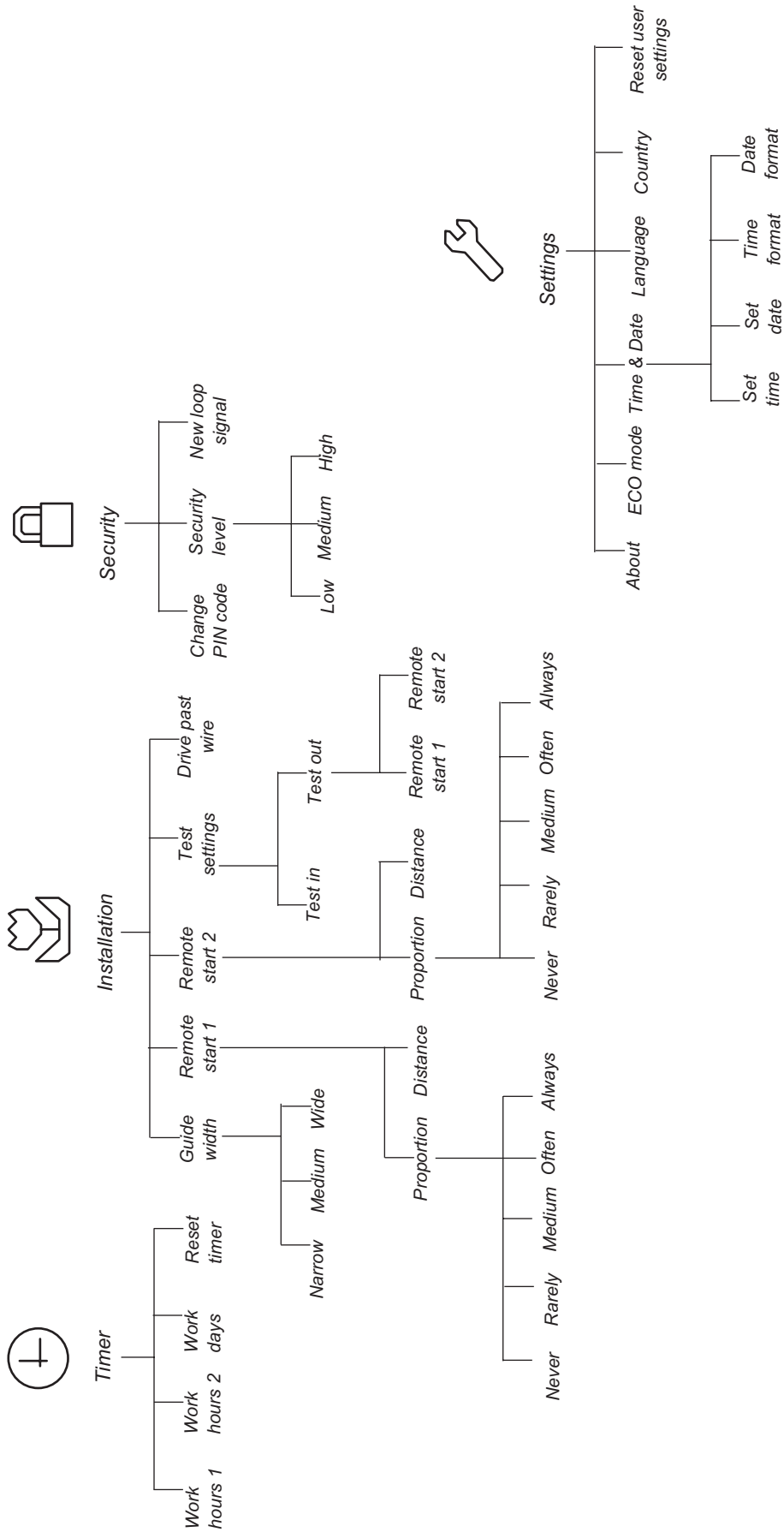

## 6. MENU FUNCTIONS

### 6.3 Timer

The lawn should not be cut too often to obtain the best mowing result. Consequently, it is important to limit the operating time using the timer function if the working area is less than the robotic lawnmower's working capacity. When the robotic lawnmower is allowed to mow too much, the lawn may appear flattened. Besides, the robotic lawnmower is subjected to unnecessary wear.

The timer function is also an ideal means to control which work hours the robotic lawnmower should not mow, for example, when the children are playing in the garden.

The factory setting is 07:00 - 23:00 (07:00-22:00 for GARDENA R38Li, R40Li, R45Li, R50Li) and it allows mowing every day of the week. This setting is suitable for the listed maximum working area.

When setting the timer, calculate that the robotic lawnmower mows about the listed amount of the number of square meters per hour and day listed in table Work capacity.

The table below provides suggestions for different timer settings depending on garden size. The table can be used to set the operating time. The times should be seen as indicative, they may need to be adjusted to suit the garden. Use the table as follows:

1. Find a work area that closest matches the garden's area.
2. Select an appropriate amount of work days per week (for some work areas 7 days may be needed).
3. Work hours per day shows how many hours a day the robotic lawnmower will be allowed to work for the selected amount of work days.
4. Suggested time interval shows a time interval that corresponds to the required work hours per day.

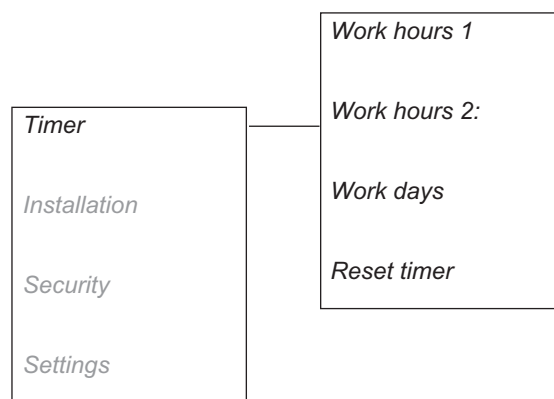

This table goes for GARDENA R38Li

Work area	Work days per week	Work hours per day	Suggested time interval
100 m <sup>2</sup>	5	4,5h	07:00 - 11:30
	7	3,5h	07:00 - 10:30
200 m <sup>2</sup>	5	9h	07:00 - 16:00
	7	6,5h	07:00 - 13:30
300 m <sup>2</sup>	6	11h	07:00 - 18:00
	7	9,5h	07:00 - 16:30
380 m <sup>2</sup>	7	12h	07:00 - 19:00

## 6. MENU FUNCTIONS

This table goes for GARDENA R40Li			
Work area	Work days per week	Work hours per day	Suggested time time interval
100 m <sup>2</sup>	5	4,5h	07:00 - 11:30
	7	3h	07:00 - 10:00
200 m <sup>2</sup>	5	8,5h	07:00 - 15:30
	7	6h	07:00 - 13:00
300 m <sup>2</sup>	6	10,5h	07:00 - 17:30
	7	9h	07:00 - 16:00
400 m <sup>2</sup>	7	12h	07:00 - 19:00

This table goes for GARDENA R45Li			
Work area	Work days per week	Work hours per day	Suggested time time interval
100 m <sup>2</sup>	5	4h	07:00 - 11:00
	7	2,5h	07:00 - 09:30
200 m <sup>2</sup>	5	7,5h	07:00 - 14:30
	7	5,5h	07:00 - 12:30
300 m <sup>2</sup>	5	11h	07:00 - 18:00
	7	8h	07:00 - 15:00
400 m <sup>2</sup>	7	10,5h	07:00 - 17:30
450 m <sup>2</sup>	7	12h	07:00 - 19:00

This table goes for GARDENA R50Li			
Work area	Work days per week	Work hours per day	Suggested time time interval
100 m <sup>2</sup>	5	3,5h	07:00 - 10:30
	7	2,5h	07:00 - 09:30
200 m <sup>2</sup>	5	7h	07:00 - 14:00
	7	5h	07:00 - 12:00
300 m <sup>2</sup>	5	10h	07:00 - 17:00
	7	7h	07:00 - 14:00
400 m <sup>2</sup>	6	11h	07:00 - 18:00
	7	9,5h	07:00 - 16:30
500 m <sup>2</sup>	7	12h	07:00 - 19:00

## 6. MENU FUNCTIONS

This table goes for GARDENA R70Li			
Work area	Work days per week	Work hours per day	Suggested time time interval
100 m <sup>2</sup>	5	3h	07:00 - 10:00
	7	2,5h	07:00 - 09:30
200 m <sup>2</sup>	5	6,5h	07:00 - 13:30
	7	4,5h	07:00 - 11:30
400 m <sup>2</sup>	5	13h	07:00 - 20:00
	7	9h	07:00 - 16:00
600 m <sup>2</sup>	6	16h	07:00 - 23:00
	7	13,5h	07:00 - 20:30
700 m <sup>2</sup>	7	16h	07:00 - 23:00

This table goes for GARDENA R80Li			
Work area	Work days per week	Work hours per day	Suggested time time interval
100 m <sup>2</sup>	5	3h	07:00 - 10:00
	7	2h	07:00 - 09:00
200 m <sup>2</sup>	5	5,5h	07:00 - 12:30
	7	4h	07:00 - 11:00
400 m <sup>2</sup>	5	11,5h	07:00 - 18:30
	7	8h	07:00 - 15:00
600 m <sup>2</sup>	6	14h	07:00 - 21:00
	7	12h	07:00 - 19:00
800 m <sup>2</sup>	7	16h	07:00 - 23:00

- **Work hours 1** to set start and stop times for work hours 1. Enter each required time in hours and minutes and press **OK** to confirm the entered time.
- **Work hours 2:** to set start and stop times for work hours 2. Enter each required time in hours and minutes and press **OK** to confirm the entered time.
- **Work days** to select the days the robotic lawnmower must work. The robotic lawnmower will work during the days that are ticked off.
- **Reset timer** reset values to the factory settings.

To inactivate Work hours 1 or Work hours 2, enter the time 00:00 - 00:00 to reset the timer to --:-- --:--.

A clock symbol is displayed on the start page when the

## 6. MENU FUNCTIONS

timer settings are set. The clock symbol is black when the robotic lawnmower is not allowed to mow due to a timer setting and it is white when the mower is allowed to mow.

The robotic lawnmower has an inbuilt standby period of about 8 hours a day (12 hours for the GARDENA R38Li, R 40Li, R45Li, R50Li). The robotic lawnmower is parked in the charging station during this period. See 4.2 *Using the timer* on page 37.

### 6.4 Installation, R70Li, R80Li

The following operating settings are available via this selection in the main menu.

- **Guide width**  
to select the distance from the guide wire the robotic lawnmower is allowed to travel when it follows this to and from the charging station.
- **Remote start 1**  
to control the robotic lawnmower so that it can easier reach remote parts of the garden.
- **Remote start 2**  
to control the robotic lawnmower so that it can easier reach remote parts of the garden.
- **Test settings**  
to check the above settings.
- **Drive past wire**  
to set the distance over the boundary wire that the robotic lawnmower should travel before turning back.

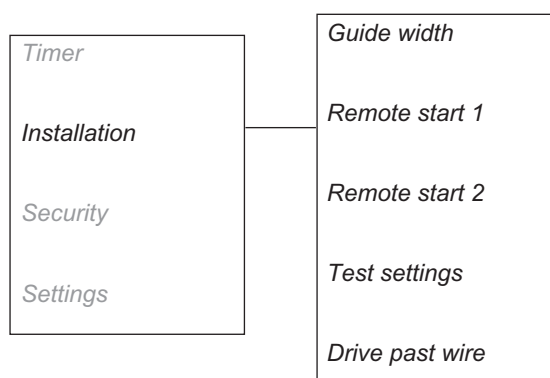

For examples of garden settings, see 7. Garden examples.

#### Guide width

The guide width is a measure of how far from the guide wire the robotic lawnmower is allowed to travel when it follows this to and from the charging station. The area beside the wire which the robotic lawnmower then uses is called the Corridor.

The robotic lawnmower has a default setting for medium wide corridors. To further reduce the risk of tracks forming, it is recommended to select a wide corridor in working areas where it is possible to do so.

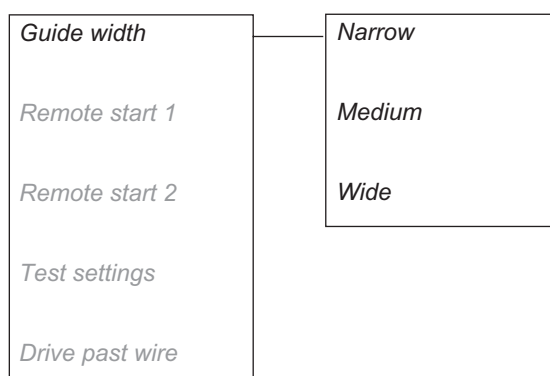

#### IMPORTANT INFORMATION

**Always use as wide a guide width as possible. The Narrow setting must only be used when none of the other settings can be used in the working area in question.**

## 6. MENU FUNCTIONS

### **Wide**

In a wide corridor, the robotic lawnmower mows at more varied distances from the guide wire.

A garden that is open and free of narrow passages should have a wide corridor to minimise the risk of tracks forming.

### **Medium**

In a medium wide corridor, the robotic lawnmower travels close to and far away from the guide wire, but not as far away from the guide wire as is the case when a wide corridor is selected.

In a medium wide corridor, the robotic lawnmower travels close to and far away from the guide wire, but not as far away from the guide wire as is the case when a wide corridor is selected.

### **Narrow**

With a narrow corridor, the robotic lawnmower runs straight over the guide wire.

The Narrow corridor setting is not normally recommended, but in a garden with one or many narrow passages, a narrow corridor may be the only option. The Narrow corridor setting increases the risk for tracks forming along the guide wire.

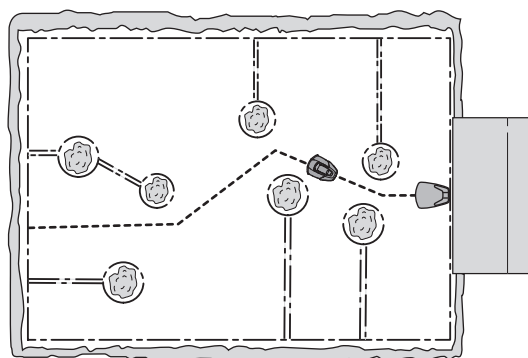
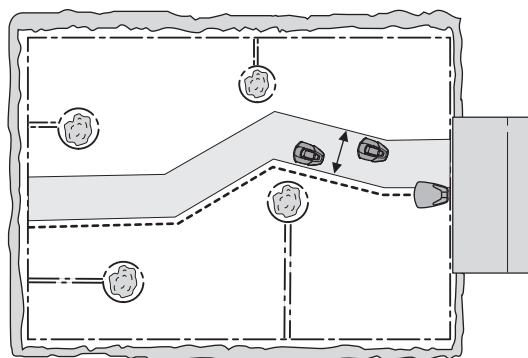

### **IMPORTANT INFORMATION**

**The distance the robotic lawnmower maintains from the guide wire varies depending on the layout of the working area. Use the Test IN function to ensure that the wide corridor setting can be used in the garden in question.**

### **Remote start 1**

One important function with the guide wire is the capacity to steer the robotic lawnmower to remote garden areas when required. This function is very useful in gardens where, for instance, the front and back are joined by a narrow passage.

With this function activated, (any option other than *Never* is selected) the robotic lawnmower will at times follow the guide wire from the charging station to the remote area and begin mowing there.



## 6. MENU FUNCTIONS

### • Proportion

How often the robotic lawnmower must follow the guide wire from the charging station is selected as a proportion of the total number of times it leaves the charging station. At all other times, the robotic lawnmower leaves the charging station in the standard manner and starts to mow.

The following five options can be selected;

- Never (0%)
- Rarely (approx. 20%)
- Medium (approx. 50%)
- Often (approx. 80%)
- Always (100%)

Select the percentage that corresponds to the size of the remote area relative to the total working area. If the remote area is for instance less than half of the total working area, then *Rarely* must be selected. If the remote area is for instance half of the total working area, *Medium* must be selected. Compare with the examples in 7. *Garden examples* on page 59.

The default setting is *Rarely*.

### • Distance

Enter the distance in metres along the guide wire from the charging station to the remote area where the robotic lawnmower begins mowing. **Tips!** Use the *Test OUT* function to determine how far it is to the remote area. The distance, stated in metres, will be shown in the robotic lawnmower's display.

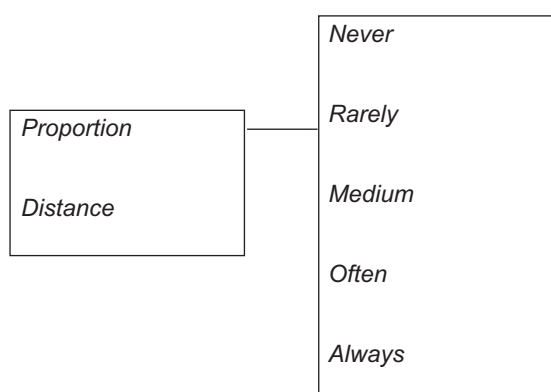

### Remote start 2

If the working area contains two remote areas, the guide wire should be installed so that it reaches both areas. *Remote start 1* and *Remote start 2* can then be combined to steer the robotic lawnmower to each area.

The settings for *Proportion* and *Distance* are carried out in the same way as for *Remote start 1*.

The default setting is *Never*.

Take into account that the total figure for *Proportion* cannot exceed 100%. If one has for instance selected *Often* for *Remote start 1*, then one can only select *Never* or *Rarely* for *Remote start 2*.

*Guide width* is the same for *Remote start 1* and *Remote start 2*. In this way, it is the narrowest passage along the guide wire that limits the maximum guide width.

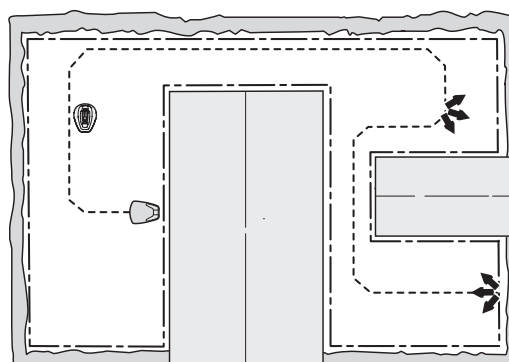

## 6. MENU FUNCTIONS

### Test settings

In the *Test settings* menu, it is possible to test the settings for *Remote start 1* and *Remote start 2* and that the selected *Guide width* works in the working area in question.

### Test OUT

The *Test OUT* function is used to test if the selected *Guide width* suits the installation in question and to calculate the distance from the charging station to a remote area.

To test the settings in *Remote start 1*:

Park the robotic lawnmower in the charging station and select *Test OUT - Remote start 1*. The robotic lawnmower will then leave the charging station straight away along the guide wire and begin mowing after the designated distance.

If there is a passage that the robotic lawnmower cannot get through, the settings in *Guide width* ought to be changed from *Wide* to *Medium*. If required, the setting can also be changed to *Narrow*. The *Narrow* guide width setting should only be used if none of the other settings work for this installation. When the *Test OUT* function is activated, the robotic lawnmower travels the farthest distance from the wire allowed by the selected guide width.

The figure here shows how the robotic lawnmower travels through a passage when *Guide width* is set to *Medium* and not to *Wide*.

How to measure the distance from the charging station to a remote area:

Enter a distance which beyond any doubt exceeds the real figure. The maximum distance that can be entered is 100 metres. Park the robotic lawnmower in the charging station and select *Test OUT*. The robotic lawnmower will immediately leave the charging station. The distance, stated in metres, will be shown in the mower display as the robotic lawnmower operates. Stop the robotic lawnmower at the required position and note the distance. Enter the displayed number of metres in the *Distance* field for the working area in question.

If *Remote start 2* has been activated, i.e. if another option other than *Never* has been selected for *Proportion*, these settings must also be tested. *Remote start 2* test is performed in the same way as for *Remote start 1*.

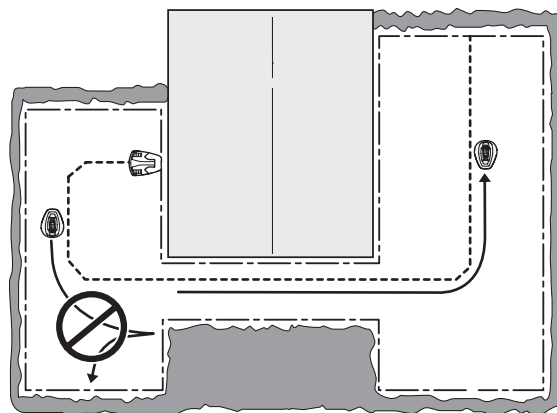
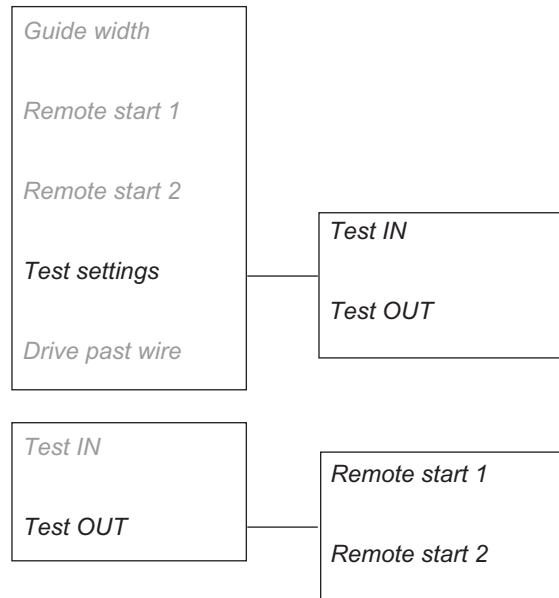

---

## 6. MENU FUNCTIONS

---

### Test IN

The *Test IN* function allows you to test how well the robotic lawnmower docks with the charging station.

*Test IN* can only be performed after *Test OUT* has been performed.

Selecting this function causes the robotic lawnmower to travel directly along the guide wire towards the charging station and to dock with it. The test is approved only if the robotic lawnmower is able to dock with the charging station at the first attempt. If the robotic lawnmower is unable to dock on the first attempt, it will automatically try again. The installation is not approved if the robotic lawnmower needs two or more attempts to dock with the charging station.

### Drive past wire

The front of the robotic lawnmower always passes the boundary wire by a specific distance before the mower turns around. The default distance is 25 cm, but this can be changed if required. The minimum value is 25 cm and the maximum value is 30 cm. Note that the distance given is only an approximate value and should be regarded as a guide. In reality, the actual distance the robotic mower passes the boundary wire can vary.

Now specify the number of centimetres you want the robotic lawnmower to pass the boundary wire and press **OK**.

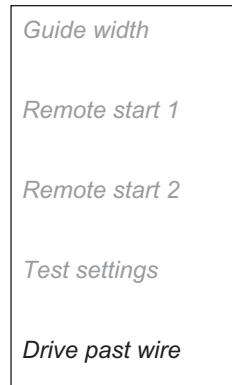

### 6.5 Security

Through this selection, settings relating to security and the connection between the mower and the charging station can be made.

#### Change PIN code

Enter the new PIN code and press **OK**. Enter the same code again and confirm by pressing **OK**. When the PIN code is changed, a message stating that the PIN code has been changed appears in the display momentarily.

Make a note of the new PIN code on the designated line in *Memo* on page 4.

#### Security level

There are three security levels to choose from: low, medium and high. Low and medium security prohibits access to the robotic lawnmower if the PIN code is unknown. High security also includes a warning that beeps if the correct PIN code is not entered after a designated time period.

To disable the robotic lawnmower, press down the stop button and set the main switch to 0.

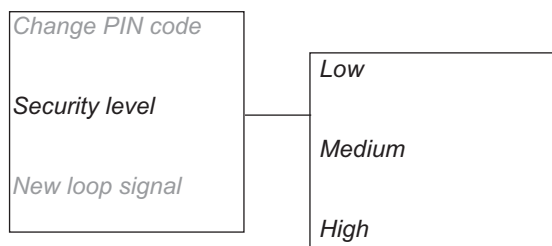
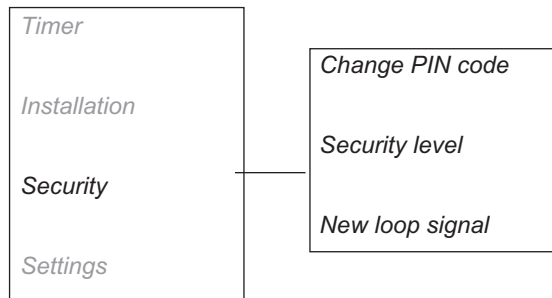

---

## 6. MENU FUNCTIONS

---

Function	Low	Medium	High
Time lock	X	X	X
PIN request		X	X
Alarm			X

### *Time lock*

This function means that the robotic lawnmower cannot be started after 30 days without first entering the correct PIN code. When the 30 days has passed the robotic lawnmower will continue to mow as normal, but the *Enter PIN code* message appears when the cover is opened. Enter your code again and press **OK**.

### PIN request

This function means that the robotic lawnmower requests a PIN code when the main switch is set to 1 and each time the cover is opened. The correct PIN code must be entered to use the robotic lawnmower.

If the wrong PIN code is entered 5 times in succession the robotic lawnmower is blocked for a time. The blockage time is extended for every new incorrect attempt.

### Alarm

This function means that an alarm sounds if the PIN code is not entered within 10 seconds after the **STOP** button has been pressed or the robotic lawnmower has been lifted up for any reason. A ticking noise indicates that the PIN code must be entered to prevent triggering the alarm. The alarm can be turned off at any time by entering the correct PIN code.

### ***New loop signal***

The loop signal is randomly selected to create a unique link between the robotic lawnmower and the charging station. In rare cases, there may be a need to generate a new signal, for instance if two adjacent installations have a very similar signal.

- Place the robotic lawnmower in the charging station.
- Select *New loop signal* in the menu and press **OK**.

*Change PIN code*

*Security level*

*New loop signal*



---

## 6. MENU FUNCTIONS

---

### 6.6 Settings

#### **About**

The About menu displays information about the robotic lawnmower's model, serial number and the different softwares.

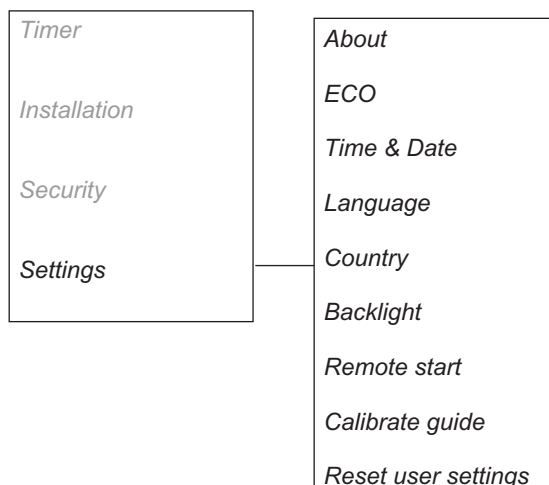

#### **ECO**

This function automatically turns off the loop signal in the boundary loop, the guide wires and the charging station when the robotic lawnmower is not mowing, i.e. when the lawnmower is charging or is not allowed to mow due to timer settings.

ECO is suitable to use where there is other wireless equipment not compatible with the robotic lawnmower e.g. certain hearing loops or garage doors.

When the loop signal is turned off due to the ECO mode, the indicator lamp in the charging station flashes green. When the indicator lamp flashes green the robotic lawnmower can only be started in the charging station and not out in the working area.

In ECO mode, it is very important to always press the STOP button before removing the robotic lawnmower from the charging station. In ECO mode it is otherwise not possible to start the robotic lawnmower. If the lawnmower has been removed by mistake without first pressing the STOP button, the lawnmower must be placed back in the charging station and the STOP button pressed. Only then can the robotic lawnmower be started inside the working area.

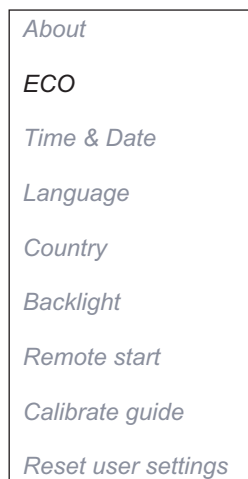

#### **IMPORTANT INFORMATION**

**Always press the STOP button before removing the robotic lawnmower from the charging station. In ECO mode the robotic lawnmower otherwise will not be started inside the working area.**

Select Run ECO and press OK to activate ECO mode.

---

## 6. MENU FUNCTIONS

---

### **Time & Date**

This function allows you to set current time and required time format in the robotic lawnmower.

- *Time*  
*Enter the correct time and press OK to exit.*
- *Time format*  
Place the cursor at the required time format:  
12h 24h. Press OK to exit.
- *Date*  
*Enter correct date and press OK to exit.*
- *Date format*  
*Place the cursor at the required date format:*  
*YYYY-MM-DD (year-month-day)*  
*MM-DD-YYYY (month-day-year)*  
*DD-MM-YYYY (day-month-year).*  
Exit by pressing OK.

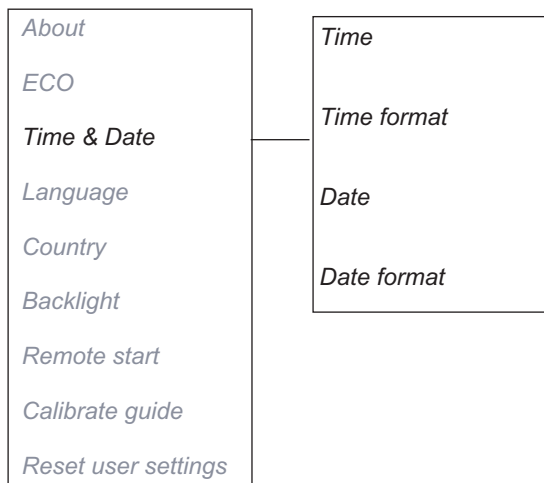

### **Language**

Set language with this function.

To select the language: Place the cursor at Language and press **OK**. Place the cursor at the required language and press **OK**.

### **Country**

With this function you can select in what country the robotic lawnmower will work.

Place the cursor at the required country and press OK.

### **Backlight, R38Li, R40Li, R45Li, R50Li**

To indicate where the robotic lawnmower is at night in the working area, it is possible to allow the display to remain on when the robotic lawnmower is in operation.

1. Select Backlight in the menu and press **OK**.
2. Select one of the following options:  
*Auto*: The display is lit for 1 minute after the latest key press.  
*ON*: The display is lit all the time when the robotic lawnmower operates. The display is not lit when the robotic lawnmower is stopped due for instance to a timer setting or possible disruption.

---

## 6. MENU FUNCTIONS

---

### **Remote start, R38Li, R40Li, R45Li, R50Li**

One important function with the guide wire is the capacity to steer the robotic lawnmower to remote garden areas when required. This function is very useful in gardens where, for instance, the front and back are joined by a narrow passage where the charging station cannot be installed.

With this function activated, (any option other than *Never* is selected) the robotic lawnmower will follow the guide wire from the charging station to the point where the guide wire connects to the boundary wire. It begins to mow when it reaches this point. How often it must follow the guide wire from the charging station is selected as a proportion of the total number of times it leaves the charging station. At all other times, the robotic lawnmower leaves the charging station in the standard manner and starts to mow.

The following five options can be selected;

- *Never* (0%)
- *Rarely* (approx. 20%)
- *Medium* (approx. 50%)
- *Often* (approx. 80%)
- *Always* (100%)

Select the percentage that corresponds to the size of the remote area relative to the total working area. If the remote area is for instance less than half of the total working area, then *Rarely* must be selected. If the remote area is for instance half of the total working area, *Medium* must be selected. Compare with the examples in 7. *Garden examples* on page 59.

The default setting is *Rarely*.

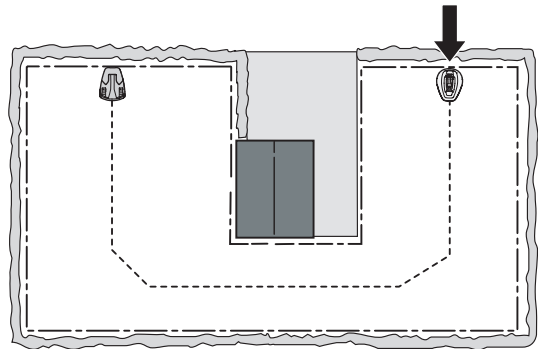



---

## 6. MENU FUNCTIONS

---

### ***Calibrate guide, R38Li, R40Li, R45Li, R50Li***

The *Calibrate guide* function allows you to test if the robotic lawnmower can follow the guide wire out from the charging station.

To test the guide wire:

1. Place the robotic lawnmower in the charging station.
2. Select *Calibrate guide* and press **OK**. The robotic lawnmower will now leave the charging station, run a calibration process in front of the charging station and then follow the guide wire to the connection point with the boundary wire and then start mowing.
3. Check that the robotic lawnmower can follow the guide wire all the way to the connection point with the boundary wire.

The test has failed if the robotic lawnmower cannot follow the guide wire all the way to the connection point with the boundary wire. It is likely that the installation has not been carried out in accordance with the instructions in 3. *Installation*. Common errors are for instance that there is not enough open space to the left of the guide wire as seen facing the charging station or that the guide wire is not laid at an angle on a steep slope. See 3.6 *Installation of the guide wire*.

Rectify the installation and run a new test with *Calibrate guide*

### ***Reset user settings***

This function allows you to reset the robotic lawnmower to the default settings it had when it left the factory.

1. Select *Reset user settings* in the menu and press **OK**. Enter the correct PIN code and press **OK**.

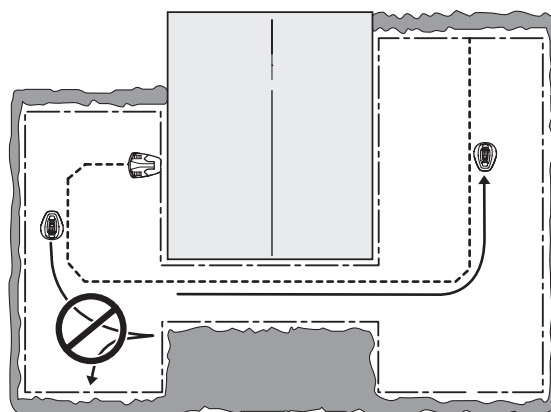

## 7. GARDEN EXAMPLES

### 7. Garden examples

#### - Installation proposals and settings

The robotic mower's behaviour is controlled to a certain extent by what settings are made. Adapting the robotic lawnmower's garden settings according to the shape of the garden makes it easier for the robotic lawnmower to frequently reach all parts of the garden and in doing so achieve a perfect mowing result.

Different gardens require different settings. The following pages outline a number of examples of gardens with installation proposals and settings.

There are also animated garden examples on [www.gardena.com](http://www.gardena.com).

See chapter 6. *Menu functions* for more detailed information about the various settings.

#### IMPORTANT INFORMATION

**The default settings for the robotic lawnmower have been selected to work in as many different gardens as possible. The settings only need to be adjusted when special installation conditions exist.**

The recommended timer settings in the following garden example are applicable to GARDENA R40Li unless otherwise stated. For other models, the operating time can be reduced, see 4.2 *Using the timer* on page 37.

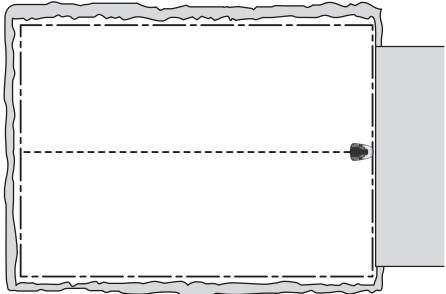
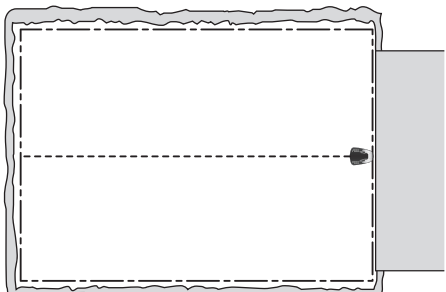
Installation proposals and settings		
Area	150 m <sup>2</sup> . Open and level area.	
Timer	07:00-17:00 Monday, Tuesday, Wednesday, Friday	
Remote start- Proportion	Never	
Remarks	The timer should be used to prevent the grass looking trampled since the area is less than the maximum capacity of the robotic lawnmower.	
Area	400 m <sup>2</sup> . Open area.	
Timer	07:00-22:00 (factory setting) Monday-Sunday	
Remote start- Proportion	Never	
Remarks	The factory settings are suitable for this installation.	

## 7. GARDEN EXAMPLES

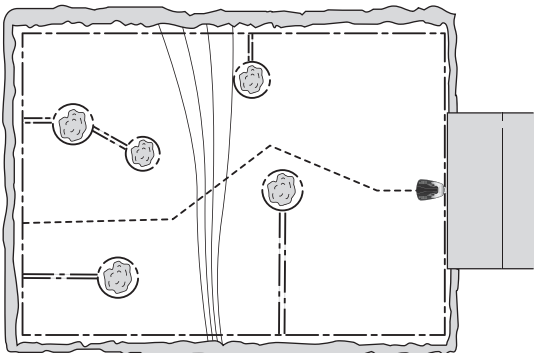
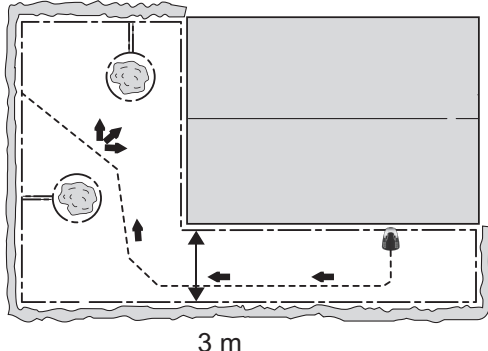
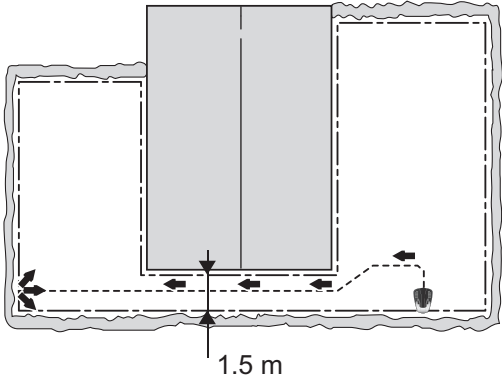
Installation proposals and settings		
<p><b>Area</b></p> <p><b>Timer</b></p> <p><b>Remote start- Proportion</b></p> <p><b>Remarks</b></p>	<p>400 m<sup>2</sup>. A number of islands and a 25% slope.</p> <p>07:00-22:00 (factory setting) Monday-Sunday</p> <p>Rarely (factory setting)</p> <p>Place the charging station in the lower part of the working area. Lay the guide wire at an angle over the steep slope.</p>	
<p><b>Area</b></p> <p><b>Timer</b></p> <p><b>Remote start- Proportion</b></p> <p><b>Remarks</b></p>	<p>200 m<sup>2</sup>. L-shaped garden with charging station installed in the narrow area. Contains a couple of islands.</p> <p>07:00-22:00 Monday, Tuesday, Wednesday, Friday</p> <p>Often</p> <p>As most of the working area can easily be reached by the robotic lawnmower following the guide wire out from the charging station, select <i>Proportion: Often</i>.</p>	 <p style="text-align: center;">3 m</p>
<p><b>Area</b></p> <p><b>Timer</b></p> <p><b>Remote start- Proportion</b></p> <p><b>Remarks</b></p>	<p>250 m<sup>2</sup>. U-shaped garden linked with a narrow passage.</p> <p>07:00 - 22:00 Monday - Friday</p> <p>Medium</p> <p>The guide wire must be placed along the narrow passage to ensure that the robotic lawnmower can with ease locate the charging station from the left hand side of the working area. The <i>Proportion Medium</i> is selected as the left hand area is nearly half of the total area.</p>	 <p style="text-align: center;">1.5 m</p>

## 7. GARDEN EXAMPLES

Installation proposals and settings		
<p><b>Area</b></p> <p><b>Timer</b></p> <p><b>Remote start- Proportion</b></p> <p><b>Remarks</b></p>	<p>150 m<sup>2</sup>. Unsymmetrical working area with a narrow passage and a number of islands.</p> <p>07:00-17:00 Monday, Tuesday, Wednesday, Friday</p> <p><i>Rarely</i> (factory setting)</p> <p>The guide wire must be placed along the narrow passage to ensure that the robotic lawnmower can with ease locate the charging station from the right hand side of the working area. Select <i>Proportion Rarely</i> as the right hand area is a small fraction of the total area.</p>	
<p><b>Area</b></p> <p><b>Timer</b></p> <p><b>Remote start 1- Proportion</b></p> <p><b>Remote start 2- Proportion</b></p> <p><b>Guide width</b></p> <p><b>Remarks</b></p>	<p>Applies to the GARDENA R70Li, R80Li only.</p> <p>400 m<sup>2</sup>. Three areas linked with two narrow passages.</p> <p>07:00-23:00 Monday, Tuesday, Thursday, Friday</p> <p><i>Rarely</i></p> <p><i>Rarely</i></p> <p><i>Medium</i></p> <p>As the working area contains three areas linked by two narrow passages, Remote start 1 and Remote start 2 must be used to obtain an even mowing result across the entire working area. The GARDENA R70Li, R80Li is therefore recommended for this working area.</p>	

## 7. GARDEN EXAMPLES

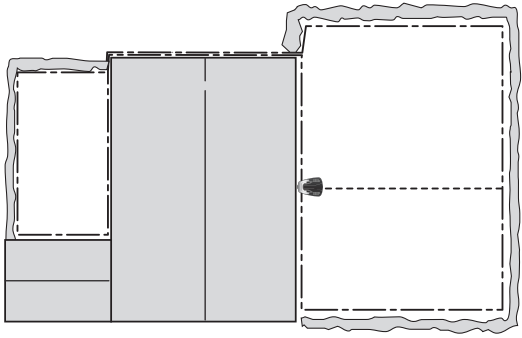
Installation proposals and settings		
Area	200 m <sup>2</sup> + 50 m <sup>2</sup> in a secondary area.	
Timer	07:00-18:00 Monday, Tuesday, Thursday, Friday	
Remote start - Proportion	<i>Rarely</i> (factory setting)	
Remarks	The secondary area is cut using the MAN mode on Wednesday and Saturday.	

---

## 8. MAINTENANCE

---

### 8. Maintenance

Check and clean the robotic lawnmower regularly and replace worn parts if necessary to improve operating reliability and to ensure a longer service life. For further information on cleaning, see *8.3 Cleaning*.

When the robotic lawnmower is first used, the blade disc and blades should be inspected once a week. If the amount of wear during this period has been low, the inspection interval can be increased.

It is important that the blade disc rotates easily. The edges of the blades should not be damaged. The lifetime of the blades varies immensely and depends for instance on:

- Operating time and size of the working area.
- Type of grass.
- Type of soil.
- The presence of objects such as cones, windfalls, toys, tools, stones, roots and the like.

The normal life is 2 to 4 months when used in areas more than 300 m<sup>2</sup> in size and longer for smaller areas. See *8.6 Replacing the blades* on page 67 on how to replace the blades.

#### IMPORTANT INFORMATION

**Working with dull blades gives a poorer mowing result. The edges of the grass are not cut clean and more energy is needed resulting in the robotic lawnmower not mowing such a large area.**

---

## 8. MAINTENANCE

---

### 8.1 Winter storage

#### Robotic lawnmower

The robotic lawnmower must be cleaned carefully before putting it away for the winter. See *8.3 Cleaning* on page 65.

To guarantee battery functionality and service life, it is very important to fully charge the robotic lawnmower before storing it away for the winter. Place the robotic lawnmower in the charging station with the hatch open until the battery icon in the display shows that the battery is fully charged. Then set the main switch to 0.

Check the condition of wear items such as blades and bearings in the rear wheel. Rectify if necessary to make sure the robotic lawnmower is in good condition prior to next season.

Store the robotic lawnmower standing on all wheels in a dry, frost-free environment, preferably in the mower's original packaging.

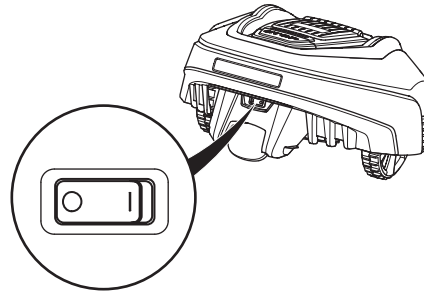

#### IMPORTANT INFORMATION

**The battery must be charged fully before winter storage. If the battery is not fully charged it can be damaged and in certain cases be rendered useless.**

#### Charging station

Store the charging station and power supply indoors. The boundary wire and the guide wire can be left in the ground. The ends of the wires should be protected from damp by putting them in a container with grease for instance.

If it is not possible to store the charging station indoors, the charging station must be connected to the mains, the boundary wire and the guide wire the entire winter.

### 8.2 After winter storage

Check if cleaning is needed, particularly the charging strips on both the robotic lawnmower and the charging station, on the first time of use. If the charging strips appear to be burnt or coated, clean them using a fine grade emery cloth. Check also that the robotic lawnmower's time and date are correct.



---

## 8. MAINTENANCE

---

### 8.3 Cleaning

It is important to keep the robotic lawnmower clean. A mower with large amounts of grass stuck to it will not cope as well with slopes. It is recommended to clean using a brush.

#### IMPORTANT INFORMATION

**Never use a high-pressure washer or even running water to clean the robotic lawnmower. Never use solvents for cleaning.**

#### Chassis and blade disc

1. Set the main switch in position 0.
2. Wear protective gloves.
3. Lift the robotic lawnmower onto its side.
4. Clean the blade disc and chassis using e.g. a dish brush.

At the same time, check that the blade disc rotates freely in relation to the foot guard.

If long blades of grass or other objects find their way in, these may impede the blade disc. Even a slight braking effect leads to a higher consumption of energy and longer mowing times, and at worst will prevent the robotic lawnmower from being able to mow a large lawn.

#### Chassis

Clean the underside of the chassis. Brush or wipe with a damp cloth.

#### Wheels

Clean around the front wheels and rear wheel as well as the rear wheel bracket.

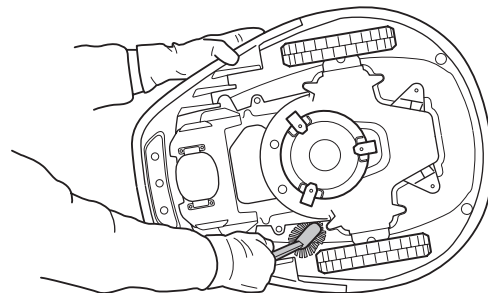
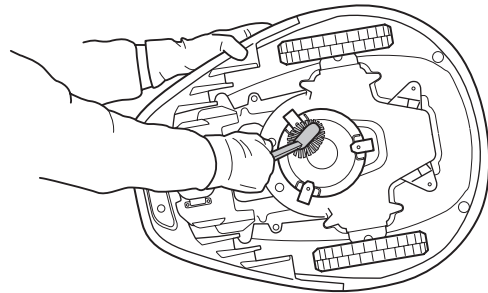
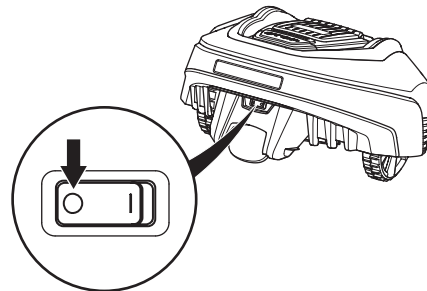
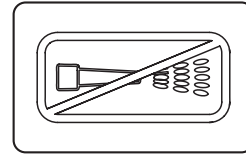

---

## 8. MAINTENANCE

---

### Body

Use a damp, soft sponge or cloth to clean the body. If the body is very dirty it may be necessary to use a soap solution or washing-up liquid.

### Charging station

Clean the charging station regularly from grass, leaves, twigs and other objects that may impede docking.

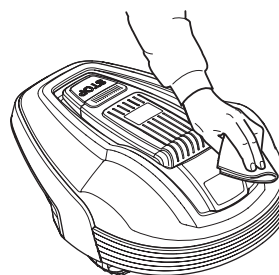

### 8.4 Transport and removal

Secure the machine during transport. It is important that the robotic lawnmower does not move when it is being transported, for instance, between lawns.

The contained lithium-ion-batteries are subject to the Dangerous Goods Legislation requirements.

For commercial transports e.g. by third parties, forwarding agents, special requirement on packaging and labeling must be observed.

For preparation of the item being shipped, consulting an expert for hazardous material is required. Please also observe possibly more detailed national regulations.

Tape or mask off open contacts and pack up the battery in such a manner that it cannot move around in the packaging.

### 8.5 In the event of a thunderstorm

To reduce the risk of damage to electrical components in the robotic lawnmower and its charging station, we recommend that all connections to the charging station are disconnected (power supply, boundary wire and guide wires) if there is a risk of a thunderstorm.

1. Make sure the wires are marked with the supplied markers to simplify reconnecting. The charging station's connections are marked AR, AL, Guide.
2. Disconnect all wires.
3. Close the cover to the charging station to protect the connections from rain.
4. Connect all the wires if there is no longer a risk of thunder. It is important that each wire is connected to the right place.

## 8. MAINTENANCE

### 8.6 Replacing the blades



#### WARNING

Always use original blades and screws when replacing. Only replacing the blades and reusing the screw can result in a screw wearing during mowing and shearing. The blades can then be propelled from under the body and cause serious injury.

There are three blades on the robotic lawnmower, which are screwed into the blade disc. All three blades and screws must be replaced at the same time to obtain a balanced mowing system.

Use GARDENA approved original blades only.

To replace the blades:

1. Set the main switch in position 0.
2. Wear protective gloves.
3. Turn the robotic lawnmower upside down.
4. Remove the 3 screws. Use a straight slot or cross-tip screwdriver.
5. Remove the blade and the screw.
6. Screw on the new blade and the new screw.
7. Check also that the blades can pivot freely.

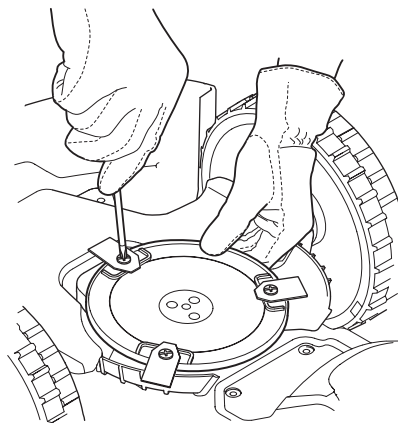
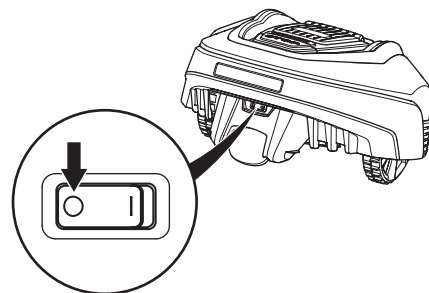

### 8.7 Replacing the battery

The battery is maintenance-free, but has a limited life span of 2 to 4 years.

Battery life is dependent on the length of the season and how many hours a day the robotic lawnmower is used. A long season or many hours of use a day means that the battery must be replaced more regularly.

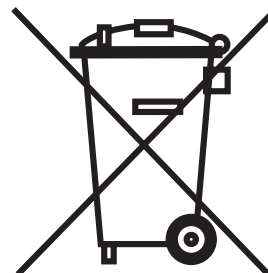

#### IMPORTANT INFORMATION

Fully charge the battery at the end of the season before winter storage.

---

## 8. MAINTENANCE

---

### Replacing the battery

If the operating times for the robotic lawnmower are shorter than normal between charges, this indicates that the battery is getting old and eventually needs power supply replacing. The battery is fine as long as the robotic lawnmower maintains a well-cut lawn.

#### IMPORTANT INFORMATION

**Always use original batteries. Compatibility with other batteries cannot be guaranteed.**

1. Set the main switch in position 0.
2. Lower the cutting height to its lowest position.
3. Turn the robotic lawnmower upside down. Place the robotic lawnmower on a soft and clean surface to avoid scratching the body and the display cover.
4. Clean around the battery cover.
5. Unscrew the four screws to the battery cover (Torx 20) and remove the battery cover.
6. Pull out the battery by pulling on the strap.
7. Fit a new original battery.  
**NOTE!** Press on the contact strip to fit the battery in place and not on the battery pack itself.
8. Fit the battery cover. If the seal on the battery cover is visibly damaged, the entire battery cover must be replaced.
9. Screw in place the four screws for the battery cover (Torx 20).
10. Reset the cutting height to the required level.

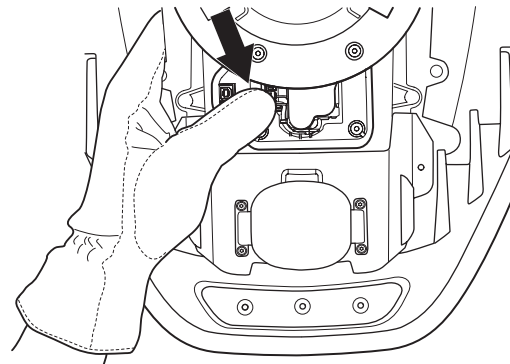
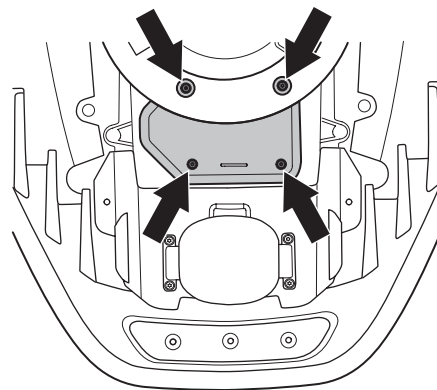

## 9. TROUBLESHOOTING

### 9. Troubleshooting

In this chapter, a number of messages are listed which may be shown in the display if there is a malfunction. There is a proposal as to the cause and steps to take for each message.

This chapter also presents some symptoms that can guide you if the robotic lawnmower does not work as expected.

More suggestions for steps to take in the event of malfunction or symptoms can be found on [www.gardena.com](http://www.gardena.com).

#### 9.1 Messages

Below a number of messages are listed which may be shown in the display of the robotic lawnmower. Contact GARDENA Central Service if the same message appears often. See *Memo* on page 4.

Message	Cause	Action
<i>Wheel motor blocked, left</i>	Grass or other object has wrapped around the drive wheel.	Check the drive wheel and remove the grass or other object.
<i>Wheel motor blocked, right</i>	Grass or other object has wrapped around the drive wheel.	Check the drive wheel and remove the grass or other object.
<i>Cutting system blocked</i>	Grass or other object has wrapped around the blade disc.	Check the blade disc and remove the grass or other object.
	The blade disc lies in a pool of water.	Move the robotic lawnmower and if possible prevent the collection of water in the working area.
<i>No loop signal</i>	The power supply is not connected.	Check the wall socket connection and whether an earth-fault breaker has tripped. Check that the low voltage cable is connected to the charging station.
	The boundary wire is not connected to the charging station	Check that the boundary wire connector is fitted properly to the charging station. See 3.5 <i>Connecting the boundary wire</i> on page 29.
	Boundary wire broken.	Find out where the break is. Replace the damaged section of the loop with a new loop wire and splice using an original coupler. See 9.4 <i>Finding breaks in the loop wire</i> on page 76.
	The boundary wire is laid in the wrong direction around an island.	Check that the boundary wire has been laid according to the instructions in chapter 3. <i>Installation</i> .
	The connection between the robotic lawnmower and the charging station has been broken.	Place the robotic lawnmower in the charging station and generate a new loop signal via Security -> <i>New loop signal</i> .
	Disturbances from metal objects (fences, reinforcement steel) or buried cables close by.	Try moving the boundary wire.

## 9. TROUBLESHOOTING

Message	Cause	Action
<i>Trapped</i>	The robotic lawnmower has got caught in something.	Free the robotic lawnmower and rectify the reason for it becoming trapped.
	The robotic lawnmower is stuck behind a number of obstacles.	Check if there are any obstacles which make it hard for the robotic lawnmower to move on from this place.
<i>Outside working area</i>	The boundary wire connections to the charging station are crossed.	Check that the boundary wire is connected correctly.
	The boundary wire is too close to the edge of the working area.	Check that the boundary wire has been laid according to the instructions in chapter 3. <i>Installation</i> .
	The working area slopes too much.	Check that the boundary wire has been laid according to the instructions in chapter 3. <i>Installation</i> .
	The boundary wire is laid in the wrong direction around an island.	Check that the boundary wire has been laid according to the instructions in chapter 3. <i>Installation</i> .
	Disturbances from metal objects (fences, reinforcement steel) or buried cables close by.	Try moving the boundary wire.
	The robotic lawnmower finds it hard to distinguish the signal from another robotic lawnmower installation close by.	Place the robotic lawnmower in the charging station and generate a new loop signal via <i>Security</i> -> <i>New loop signal</i> .
<i>Low battery</i> <i>Empty battery</i>	The robotic lawnmower cannot find the charging station.	Check that the charging station and the guide wire are installed in accordance with the instructions in Chapter 3. <i>Installation</i> on page 17.
	The guide wire is broken or not connected.	Check that the indicator lamp in the charging station flashes yellow. See the solution in 9.2 <i>Indicator lamp in the charging station</i> on page 73.
	The battery is spent.	Replace the battery. See 8.7 <i>Replacing the battery</i> on page 67.
	The charging station's antenna is defective.	Check if the indicator lamp in the charging station flashes red. See the solution in 9.2 <i>Indicator lamp in the charging station</i> on page 73.
<i>Wrong PIN</i>	Wrong PIN code has been entered. Five attempts are permitted, and the keypad is then blocked for five minutes.	Enter the correct PIN code. Contact GARDENA Central Service if you forget the PIN code. See <i>Memo</i> on page 4.

## 9. TROUBLESHOOTING

Message	Cause	Action
<i>Wheel motor overloaded, right</i> <i>Wheel motor overloaded, left</i>	The robotic lawnmower has got caught in something.	Free the robotic lawnmower and rectify the reason for the lack of drive. If it is due to wet grass, wait until the lawn has dried before using the robotic lawnmower.
<i>No drive</i>	The robotic lawnmower has got caught in something.	Free the robotic lawnmower and rectify the reason for the lack of drive. If it is due to wet grass, wait until the lawn has dried before using the robotic lawnmower.
	The working area includes a steep slope.	Maximum guaranteed slope is 25%. Steeper slopes should be isolated. See 3.4 <i>Installation of the boundary wire</i> on page 23.
	The guide wire is not laid at an angle on a slope.	If the guide wire is laid on a slope, it must be laid at an angle across the slope. See 3.6 <i>Installation of the guide wire</i> on page 30.
<i>Charging station blocked</i>	The contact between the charging strips and contact strips may be poor and the robotic lawnmower has made a number of attempts to charge.	Put the robotic lawnmower in the charging station and check that the charging strips and contact strips make good contact.
	An object is obstructing the robotic lawnmower.	Remove the object.
<i>Stuck in charging station</i>	There is an object in the way of the robotic lawnmower preventing it from leaving the charging station.	Remove the object.
<i>Upside down</i>	The robotic lawnmower is leaning too much or has turned over.	Turn the robotic lawnmower the right way up.
<i>Needs manual charging</i>	The robotic lawnmower is set in the <i>MAN</i> operating mode.	Place the robotic lawnmower in the charging station. This behaviour is normal and no action is required.
<i>Next start hh:mm</i>	The timer setting prevents the robotic lawnmower from operating.	Change the timer settings. See 6.3 <i>Timer</i> on page 46.
	The rest period is in progress. The robotic lawnmower has an inbuilt standby period according to the Standby time table.	This behaviour is normal and no action is required. See 4.2 <i>Using the timer</i> on page 37.
<i>The day's mowing is complete</i>	The rest period is in progress. The robotic lawnmower has an inbuilt standby period according to the Standby time table.	This behaviour is normal and no action is required. See 4.2 <i>Using the timer</i> on page 37.
<i>Lifted</i>	The lift sensor has been activated as the mower has become trapped.	Free the mower.
<i>Collision sensor problem, front/rear</i>	Mower body cannot move freely around its chassis.	Check that the mower body can move freely around its chassis.



---

## 9. TROUBLESHOOTING

---

<b>Message</b>	<b>Cause</b>	<b>Action</b>
<i>Wheel drive problem, right/left</i>	Grass or other object is wrapped around the drive wheel.	Clean the wheels and around the wheels.
<i>Alarm! Mower switched off</i>	The alarm was activated because the mower was switched OFF.	Adjust the mower security level in the Security menu.
<i>Alarm! Mower stopped</i>	The alarm was activated because the mower was stopped.	Adjust the mower security level in the Security menu.
<i>Alarm! Mower lifted</i>	The alarm was activated because the mower was lifted.	Adjust the mower security level in the Security menu.
<i>Alarm! Mower tilted</i>	The alarm was activated because the mower was tilted.	Adjust the mower security level in the Security menu.
<i>Temporary battery problem</i>	Temporary battery or software related issue in the mower.	Restart the mower. Disconnect and reconnect the battery.
<i>Charging current too high</i>	Wrong or faulty power supply unit.	The message may require action by authorized service technician.

## 9. TROUBLESHOOTING

### 9.2 Indicator lamp in the charging station

For a fully functional installation, the indicator lamp in the charging station must emit a solid green light. If something else appears, follow the troubleshooting guide below.

There is more troubleshooting help on [www.gardena.com](http://www.gardena.com). If you still need help with troubleshooting, please contact GARDENA Central Service. See *Memo* on page 4.

Light	Cause	Action
<i>Solid green light</i>	Everything in order	No action required
<i>Green flashing light</i>	The signals are good and ECO mode is activated.	No action required. For more information on ECO mode, see 6.6 Settings.
<i>Blue flashing light</i>	The boundary loop is not connected to the charging station	Check that the boundary wire connector is fitted properly to the charging station. See 3.5 <i>Connecting the boundary wire</i> on page 29.
	Break in the boundary loop	Find out where the break is. Replace the damaged section of the boundary wire with a new loop wire and splice using an original coupler. See 9.4 <i>Finding breaks in the loop wire</i> on page 76.
<i>Yellow flashing light</i>	The guide wire is not connected to the charging station	Check that the guide wire connector is properly connected to the charging station. See 9.4 <i>Finding breaks in the loop wire</i> on page 76.
	Break in the guide wire	Find out where the break is. Replace the damaged section of the guide wire with a new loop wire and splice using an original coupler.
<i>Red flashing light</i>	Interruption in the charging station's antenna	Contact GARDENA Central Service. See <i>Memo</i> on page 4.
<i>Solid blue light</i>	Weak signal as the boundary wire is too long.	No steps have to be taken if the robotic lawnmower operates as expected.
		Shorten the boundary wire by reducing the working area or replacing islands with barriers the robotic lawnmower can collide with.
<i>Solid red light</i>	Defective circuit board in the charging station	Contact GARDENA Central Service. See <i>Memo</i> on page 4.

## 9. TROUBLESHOOTING

### 9.3 Symptoms

If your robotic lawnmower does not work as expected, follow the troubleshooting guide below.

There is a FAQ (Frequently Asked Questions) on [www.gardena.com](http://www.gardena.com) which provides more detailed answers to a number of standard questions. Contact GARDENA Central Service if you still cannot find the reason for the fault. See *Memo* on page 4.

Symptom	Cause	Action
<b>The robotic lawnmower has difficulty docking</b>	The boundary wire is not laid in a long straight line that is far enough out from the charging station.	Check that the charging station has been installed according to the instructions in <i>9.4 Finding breaks in the loop wire</i> on page 76.
	The guide wire is not inserted in the slot at the bottom of the charging station.	It is absolutely critical for operation that the guide wire is perfectly straight and is in the correct position under the charging station. Therefore make sure that the guide wire is always in its slot in the charging station. See <i>3.6 Installation of the guide wire</i> .
	The charging station is on a slope	Place the charging station on a surface that is entirely level. See <i>3.2 Installation of the charging station</i> on page 18.
<b>Uneven mowing results</b>	The robotic lawnmower works too few hours per day.	Increase the mowing time. See <i>6.3 Timer</i> on page 46.
	The proportion setting is incorrect in relation to the layout of the working area	Check that the correct <i>Proportion</i> value is selected.
	The shape of the working area requires the use of both <i>Remote start 1</i> and <i>Remote start 2</i> for the robotic lawnmower to find its way to all remote areas.	Also use <i>Remote start 2</i> to steer the robotic lawnmower to a remote area. See <i>6.4 Installation, R70Li, R80Li</i> on page 49. Applies to the GARDENA R70Li, R80Li only.
	Working area too large.	Try limiting the working area or extending the working time. See <i>6.3 Timer</i> on page 46.
	Dull blades.	Replace all the blades and screws so that the rotating parts are balanced. See <i>8.6 Replacing the blades</i> on page 67.
	Long grass in relation to the set cutting height.	Increase the cutting height and then successively lower.
	Accumulation of grass by the blade disc or around the motor shaft.	Check that the blade disc rotates freely and easily. If not, screw off the blade disc and remove grass and foreign objects. See <i>8.3 Cleaning</i> on page 65.

## 9. TROUBLESHOOTING

Symptom	Cause	Action
<b>The robotic lawnmower runs at the wrong time</b>	The robotic lawnmower clock needs to be set.	Set the clock. See <i>6.6 Settings</i> on page 55.
	The start and stop times for mowing are incorrect.	Reset the start time and stop time settings for mowing. See <i>6.3 Timer</i> on page 46.
<b>The robotic lawnmower vibrates</b>	Damaged blades lead to imbalance in the cutting system.	Inspect the blades and screws and replace them if necessary. See <i>8.6 Replacing the blades</i> on page 67.
	Many blades in the same position lead to imbalance in the cutting system.	Check that only one blade is fitted at each screw.
<b>The robotic lawnmower runs, but the blade disc does not rotate</b>	The robotic lawnmower searches for the charging station.	No action The blade disc does not rotate when the robotic lawnmower is searching for the charging station.
<b>The robotic lawnmower mows for shorter periods than usual between charges</b>	Grass or other foreign object blocks the blade disc.	Remove and clean the blade disc. See <i>8.3 Cleaning</i> on page 65.
<b>Both the mowing and charging times are shorter than usual</b>	The battery is spent.	Replace the battery. See <i>8.7 Replacing the battery</i> on page 67.
<b>The robotic lawnmower is parked for hours in the charging station.</b>	The robotic lawnmower has an inbuilt standby period according to the Standby time table. See <i>4.2 Using the timer</i> on page 37.	No action
	The cover has been closed without the <b>START</b> button first being pressed.	Open the cover, press the <b>START</b> button and then close the cover.

---

## 9. TROUBLESHOOTING

---

### 9.4 Finding breaks in the loop wire

Breaks in the loop wire are usually the result of unconscious physical damage to the wire such as when gardening with a shovel. In countries with ground frost, even sharp stones that move in the ground can damage the wire. Breaks can also be due to the high tension in the wire during installation.

Mowing the grass too low right after the installation can damage wire insulation. Certain damage to the insulation may not cause disruptions until several weeks or months later. To avoid this, always select the maximum cutting height the first weeks after installation and then lower the height one step at a time every second week until the desired cutting height has been reached.

A defective splicing of the loop wire can also lead to disruptions first several weeks after the splice was done. A faulty splice can, for example, be the result of the original coupler not being pressed together hard enough with a pair of pliers, or a coupler of lower quality than original coupler has been used. Please first check all known splices before further troubleshooting is done.

A break can be located by gradually halving the distance of the loop wire where the break may have occurred until there is only a very short section of the wire left.

1. Make sure the indicator lamp in the charging station flashes blue, which indicates a break in the boundary loop. See *9.2 Indicator lamp in the charging station* on page 73.
2. Check that the boundary wire connections to the charging station are properly connected and not damaged. Check that the indicator lamp in the charging station is still flashing blue.

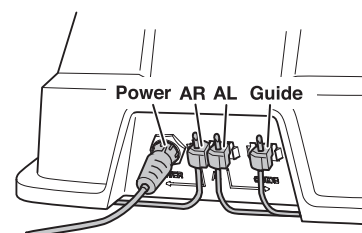
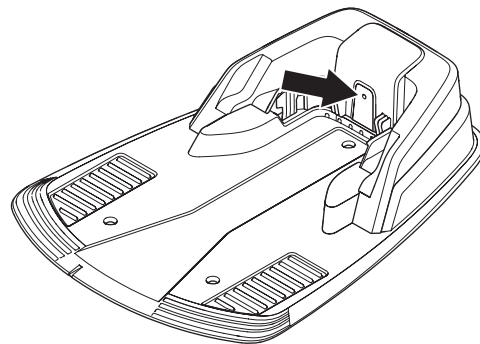

## 9. TROUBLESHOOTING

3. Connect the charging station to the power supply. Switch the connections between the guide wire and the boundary wire in the charging station.

a) Switch connection AL and Guide.

If the indicator lamp flashes yellow, then the break is somewhere on the boundary wire between AL and the point where the guide wire is connected to the boundary wire (thick black line in the illustration).

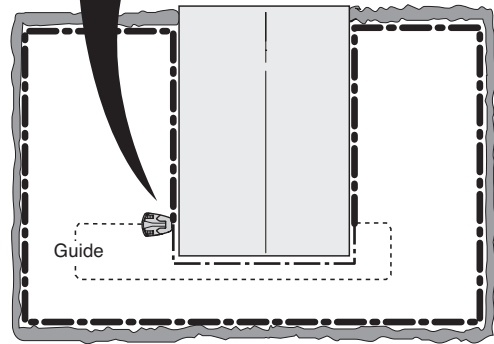
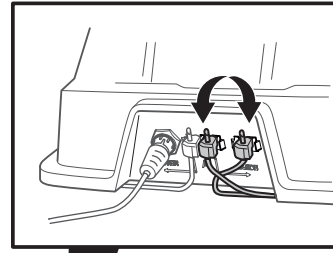

b) Put AL and Guide back in their original positions. Then switch AR and Guide.

If the indicator lamp flashes yellow, then the break is somewhere on the boundary wire between AR and the point where the guide wire is connected to the boundary wire (thick black line in the illustration).

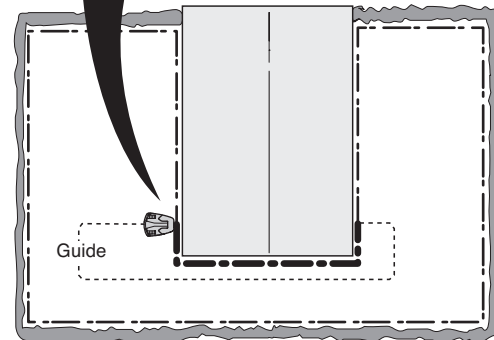
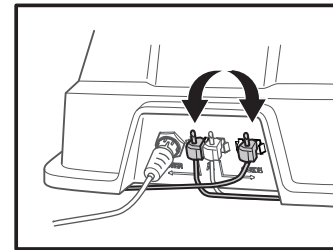

## 9. TROUBLESHOOTING

4. a) Assume that the indicator lamp flashed yellow in test a) above. Reset all connections to their original positions. Then disconnect AR. Connect a new loop wire to AR. Connect the other end of this new loop wire somewhere at the centre of the installation.

If the indicator lamp is green or flashing yellow, then the break is somewhere in the wire between the disconnected end to the point where the new wire is connected (thick black line in the illustration below).

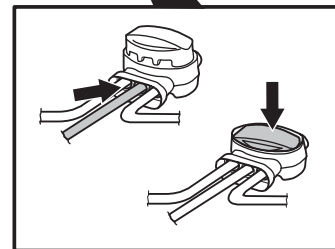
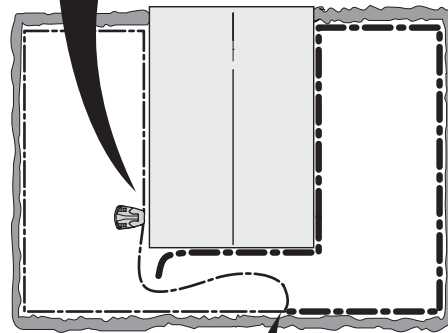
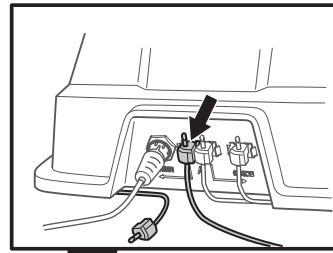

In that case, move the connection for the new wire closer to the disconnected end (roughly at the middle of the suspected wire section) and check again if the indicator lamp is green or flashes yellow.

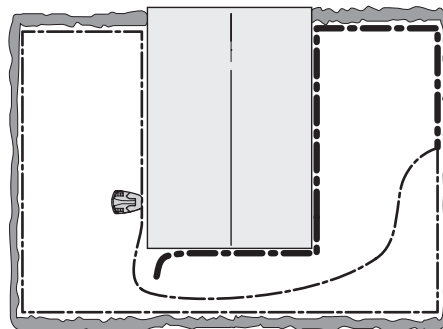



---

## 9. TROUBLESHOOTING

---

Continue until only a very short section of the wire remains which is the difference between a flashing blue light and a solid green light.

b) If the indicator lamp flashed yellow in test 3b) above, a similar test is carried out but with the new loop wire connected to AL instead.

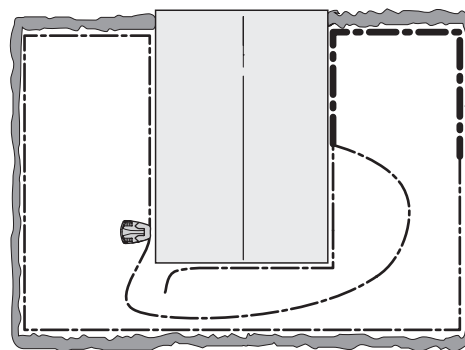

5. When the break is found, the damaged section must be replaced with a new wire. The damaged section can be cut out if it is possible to shorten the boundary wire. Always use original couplers.

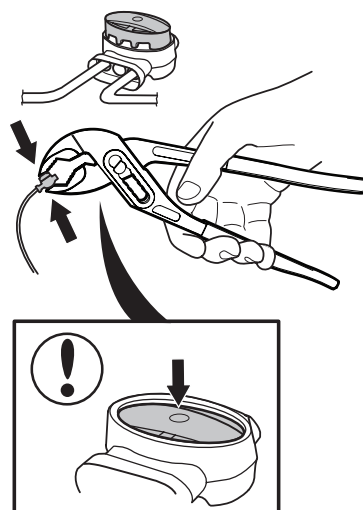

# 10. TECHNICAL DATA

## 10. Technical Data

Data	R38Li	R40Li	R45Li
<b>Dimensions</b>			
Length	58 cm	58 cm	58 cm
Width	46 cm	46 cm	46 cm
Height	26 cm	26 cm	26 cm
Weight	7,5 kg	7,5 kg	7,5 kg
<b>Electrical system</b>			
Battery	Lithium-Ion battery, 18 V/2.1 Ah Art.No 586 57 62-01		
Power supply	100-240 V/28 V DC		
Low voltage cable length	10 m	10 m	10 m
Mean energy consumption at maximum use	4 kWh/month in a 380 m <sup>2</sup> working area	4 kWh/month in a 400 m <sup>2</sup> working area	4 kWh/month in a 450 m <sup>2</sup> working area
Charge current	1.3A DC	1.3A DC	1.3A DC
Average mowing time	70 min	70 min	70 min
Average charging time	50 min	50 min	50 min
<b>Noise emissions measured in the environment as sound power *</b>			
Measured sound power noise level**)	56 dB (A)	56 dB (A)	56 dB (A)
Guaranteed sound power noise level	58 dB (A)	58 dB (A)	58 dB (A)
Sound pressure noise level at the operator's ear***)	45 dB(A)	45 dB(A)	45 dB(A)
<b>Mowing</b>			
Cutting system	Three pivoted cutting blades		
Blade motor speed	2900 rpm	2900 rpm	2900 rpm
Power consumption during cutting	20 W +/- 20%	20 W +/- 20%	20 W +/- 20%
Cutting height	2-5 cm	2-5 cm	2-5 cm
Cutting width	17 cm	17 cm	17 cm
Narrowest possible passage	90 cm	90 cm	90 cm
Maximum angle for cutting area	25%	25%	25%
Maximum angle for boundary wire	15%	15%	15%
Maximum length boundary wire	400 m	400 m	400 m
Working capacity	380 m <sup>2</sup> +/- 20%	400 m <sup>2</sup> +/- 20%	450 m <sup>2</sup> +/- 20%
<b>IP-classification</b>			
Robotic lawnmower	IPX4	IPX4	IPX4
Charging station	IPX1	IPX1	IPX1
Transformer	IPX4	IPX4	IPX4

\* Noise emissions in the environment measured as sound power (LWA) in conformity with EC directive 2000/14/EC. The guaranteed sound power level includes variation in production as well as variation from the test code with 1-3 dB(A).

\*\*) Noise emissions uncertainties KWA 2 dB(A)

\*\*\*) Sound pressure noise uncertainties KPA 2-4 dB(A)

Full compatibility cannot be guaranteed between the robotic lawnmower and other types of wireless systems such as remote controls, radio transmitters, hearing loops, buried electric animal fencing or similar.

## 10. TECHNICAL DATA

Data	R50Li	R70Li	R80Li
<b>Dimensions</b>			
Length	58 cm	58 cm	58 cm
Width	46 cm	46 cm	46 cm
Height	26 cm	26 cm	26 cm
Weight	7,5 kg	7,5 kg	7,5 kg
<b>Electrical system</b>			
Battery	Lithium-Ion battery, 18 V/2.1 Ah Art.No 586 57 62-01		
Power supply	100-240 V/28 V DC		
Low voltage cable length	10 m	10 m	10 m
Mean energy consumption at maximum use	4,5 kWh/month in a 500 m <sup>2</sup> working area	5,2 kWh/month in a 700 m <sup>2</sup> working area	5,8 kWh/month in a 800 m <sup>2</sup> working area
Charge current	1.3A DC	1.3A DC	1.3A DC
Average mowing time	70 min	65 min	65 min
Average charging time	50 min	50 min	50 min
<b>Noise emissions measured in the environment as sound power *</b>			
Measured sound power noise level**)	56 dB (A)	58 dB (A)	58 dB (A)
Guaranteed sound power noise level	58 dB (A)	60 dB (A)	60 dB (A)
Sound pressure noise level at the operator s ear***)	45 dB(A)	47 dB(A)	47 dB(A)
<b>Mowing</b>			
Cutting system	Three pivoted cutting blades		
Blade motor speed	2900 rpm	2900 rpm	2900 rpm
Power consumption during cutting	20 W +/- 20%	20 W +/- 20%	20 W +/- 20%
Cutting height	2-5 cm	2-5 cm	2-5 cm
Cutting width	17 cm	17 cm	17 cm
Narrowest possible passage	90 cm	60 cm	60 cm
Maximum angle for cutting area	25%	25%	25%
Maximum angle for boundary wire	15%	15%	15%
Maximum length boundary wire	400 m	400 m	400 m
Working capacity	500 m <sup>2</sup> +/- 20%	700 m <sup>2</sup> +/- 20%	800 m <sup>2</sup> +/- 20%
<b>IP-classification</b>			
Robotic lawnmower	IPX4	IPX4	IPX4
Charging station	IPX1	IPX1	IPX1
Transformer	IPX4	IPX4	IPX4

\* Noise emissions in the environment measured as sound power (LWA) in conformity with EC directive 2000/14/EC. The guaranteed sound power level includes variation in production as well as variation from the test code with 1-3 dB(A).

\*\*) Noise emissions uncertainties KWA 2 dB(A)

\*\*\*) Sound pressure noise uncertainties KPA 2-4 dB(A)

Full compatibility cannot be guaranteed between the robotic lawnmower and other types of wireless systems such as remote controls, radio transmitters, hearing loops, buried electric animal fencing or similar.

---

# 11. GUARANTEE TERMS

---

## 11. Guarantee terms

GARDENA guarantees this product's functionality for a period of two years (from date of purchase). The guarantee covers serious faults relating to materials or manufacturing faults. Within the guarantee period, we will replace the product or repair it at no charge if the following terms are met:

- The robotic lawnmower and the charging station may only be used in compliance with the instructions in this Operator's Manual.
- Users or non-authorized third parties are not permitted to attempt to repair the product.

Examples of faults which are not included in the guarantee:

- Damage caused by water seepage from underneath the robotic lawnmower. This damage is normally caused by laundry or irrigation systems or holes/hollows in the working area when pools of water are formed when it rains.
- Damage caused by shortened low-voltage cable.
- Damage caused by lightning.
- Damage caused by incorrect battery storage or handling.
- Damage caused by using a battery that is not an original battery.
- Damage caused by not using GARDENA AB original spare parts and accessories, such as blades and installation material.
- Damage to the loop wire.
- Damage to the body or its suspension caused by improper storage.

The blades and wheels are seen as disposable and are not covered by the guarantee.

If an error occurs with your GARDENA robotic lawnmower, please contact GARDENA Central Services (see *Memo* on page 4) for further instructions. Please have the receipt and the robotic lawnmower's serial number at hand when contacting GARDENA Central Service.

---

## 12. ENVIRONMENTAL INFORMATION

---

### 12. Environmental information

Symbols on the GARDENA robotic lawnmower or its packaging indicate that this product cannot be handled as domestic waste. It should instead be left at a suitable recycling centre to recycle its electronic components and batteries. See 8.7 Replacing the battery for disassembling of the battery.

By ensuring that this product is taken care of correctly, you can help to counteract the potential negative impact on the environment and people that can otherwise result through the incorrect waste management of this product.

For more detailed information about recycling this product, contact your municipality, your domestic waste service or the shop from where you purchased the product.

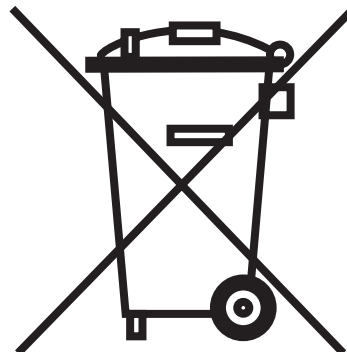

---

## 13. EU DECLARATION OF CONFORMITY

---

### 13. EU Declaration of Conformity

#### EU Declaration of conformity (Only applies to Europe)

Husqvarna AB, SE-561 82 Huskvarna, Sweden, tel.: +46-36-146500, hereby declares under sole responsibility that the robotic lawnmowers **GARDENA R38Li, GARDENA R40Li, GARDENA R45Li, GARDENA R50Li, GARDENA R70Li & GARDENA R80Li** with serial numbers dating year 2015 week 44 and onwards (the year and week is clearly stated on the rating plate, followed by the serial number), comply with the requirements of the COUNCIL'S DIRECTIVE:

- Directive "relating to machinery" **2006/42/EC**.
  - Particular requirements for robotic battery powered electrical lawnmowers **EN 50636-2-107:2015**
  - **Electromagnetic fields EN 62233.2008**
- Directive on "restriction of use of certain hazardous substances" **2011/65/EU**
- Directive "relating to noise emissions from outdoor equipment" **2000/14/EC**.

See also the Technical Data chapter for information regarding noise emissions and the cutting width. The notified body 0404, SMP Svensk Maskinprovning AB, Fyrisborgsgatan 3, SE-754 50 Uppsala, Sweden, has issued the report regarding the assessment of conformity according to annex VI to the COUNCIL'S DIRECTIVE of May 8, 2000 "relating to noise emissions in the environment" **2000/14/EC**.

The certificates have got the numbers: **01/901/204** for GARDENA R70Li & GARDENA R80Li, **01/901/163** for GARDENA R38Li, GARDENA R40Li, GARDENA R45Li & GARDENA R50Li.
- Directive "relating to electromagnetic compatibility" **2014/30/EU** and applicable supplements. The following standards have been applied:
  - **61000-6-3:2007/A1:2011** (emission)
  - **61000-6-1:2007** (immunity)

Huskvarna, 26 October 2015



Eric Stegemyr

Vice President Electric Category

Director R&D Electric Category (acting)

(Authorized representative for Husqvarna AB and responsible for technical documentation)









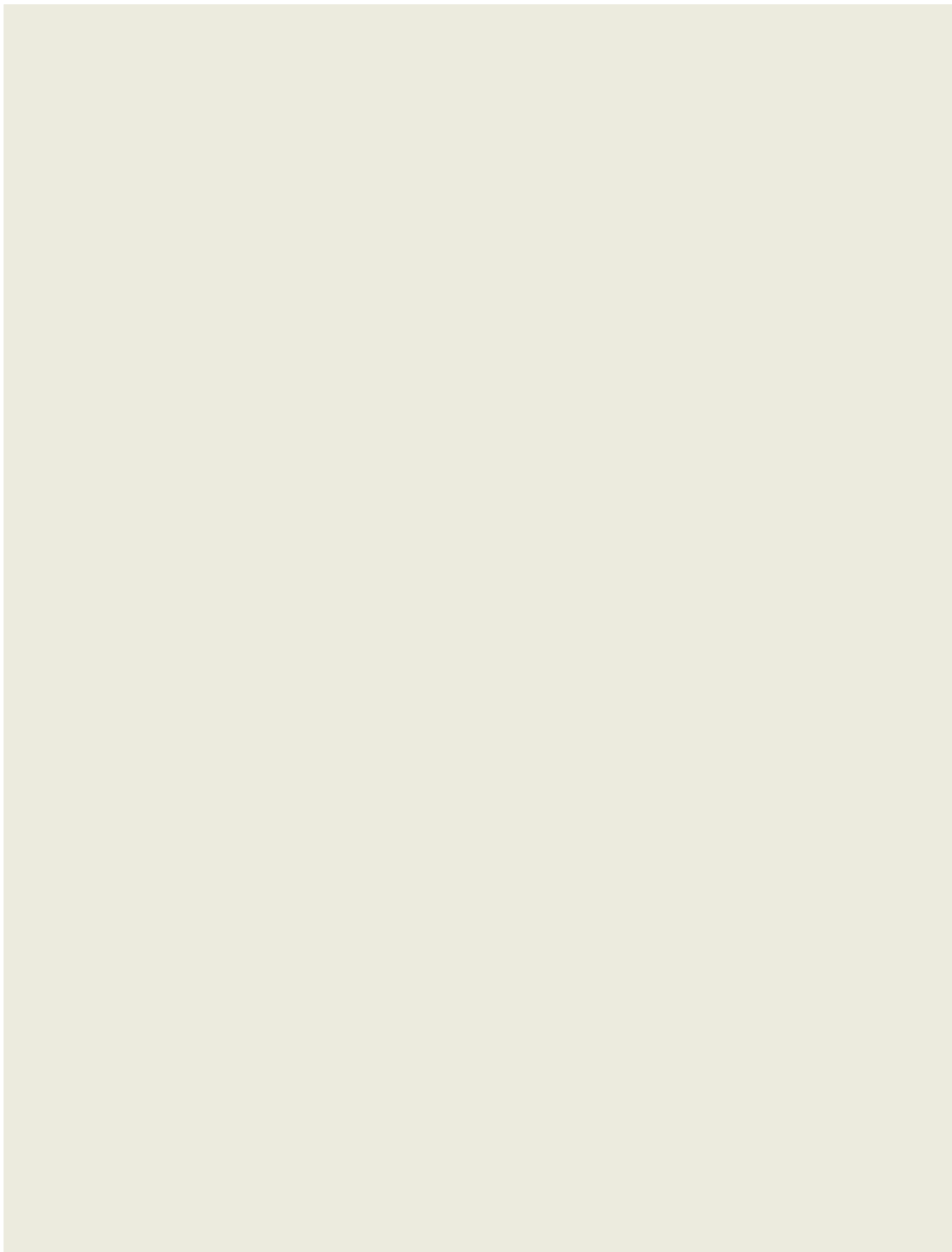
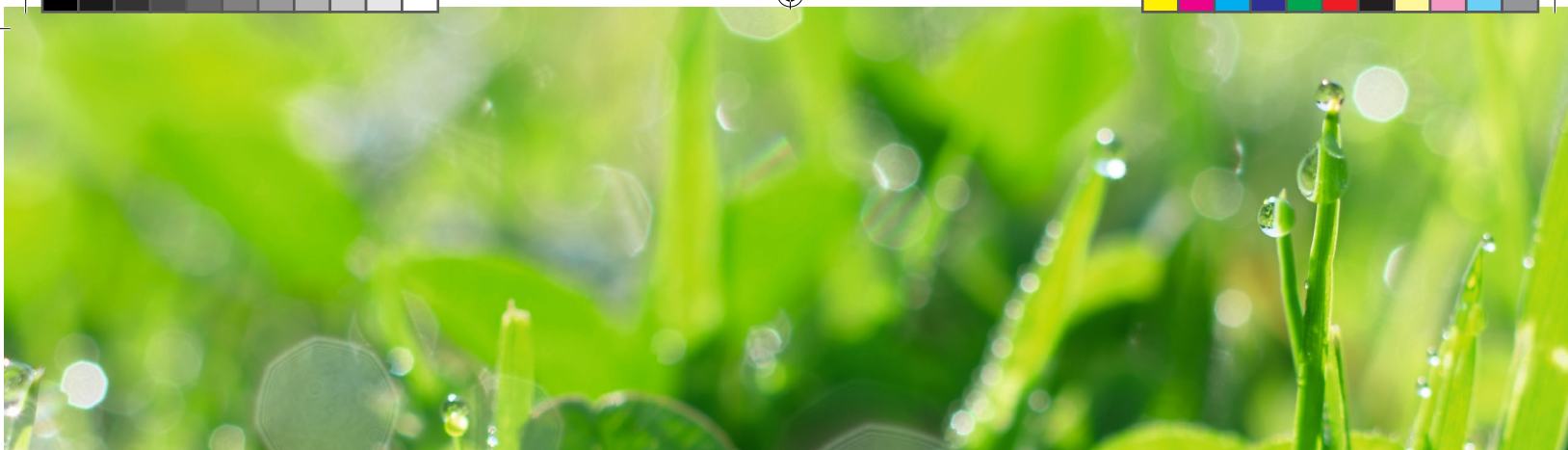

[WWW.GARDENA.COM](http://WWW.GARDENA.COM)



ORIGINAL INSTRUCTIONS

We reserve the right to make changes without prior notice.  
Copyright © 2015 GARDENA Manufacturing GmbH. All rights reserved.

115 78 71-26

