



**HUSQVARNA AUTOMOWER®
420/430X/450X
OPERATOR'S MANUAL**







1 Introduction and Security			
1.1 Introduction			
1.2 Symbols on the Product			
1.3 Symbols in the Operator's Manual			
1.4 Safety Instructions			
2 Presentation			
2.1 What's What?			
2.2 Package Contents			
2.3 Function			
3 Installation			
3.1 Preparations			
3.2 Installation of Charging Station			
3.3 Charging the Battery			
3.4 Installation of Boundary Wire			
3.5 Connecting the Boundary Wire			
3.6 Installation of Guide Wire			
3.7 Checking the Installation			
3.8 First Start-up and Calibration			
3.9 Test Docking with the Charging Station			
4 Usage			
4.1 Charging a Discharged Battery			
4.2 Using the Timer			
4.3 Start			
4.4 Stop			
4.5 Switching Off			
4.6 Adjusting Cutting Height			
5 Control Panel			
5.1 Operating Mode Start			
5.2 Operation Mode Parking			
5.3 Main Switch			
5.4 The Charging Station's PARK Button			
6 Menu Functions			
6.1 Main Menu			
6.2 Menu Structure			
6.3 Timer			
6.4 Cutting Height			
6.5 Security			
6.6 Messages			
6.7 Weather Timer			
6.8 Installation			
6.9 Settings			
6.10 Accessories			
7 Yard Examples			
8 Maintenance			
8.1 Winter Storage			
8.2 Winter Service			
8.3 After Winter Storage			
8.4 Cleaning			
8.5 Transport and Moving			
8.6 In Case of Thunderstorms			
8.7 Blades			
8.8 Battery			
3 9 Trouble Shooting			80
3 9.1 Fault Messages			80
4 9.2 Info Messages			83
6 9.3 Indicator Lamp in Charging Station			84
6 9.4 Symptom			85
10 9.5 Finding Breaks in the Loop Wire			87
10 Technical Data			91
11 Warranty Terms			92
12 Environmental Info			93
12.1 Removal of Battery for Recycling			93





MEMO

Serial
number: _____

PIN code: _____

Dealer: _____

Dealer
phone: _____

If the robotic lawnmower is stolen, it is important to notify Husqvarna AB of this. Contact your local dealer and provide the product's serial number so that it can be registered as stolen in an international database. This is an important step in the robotic lawnmower's theft protection which reduces interest in the buying and selling of stolen robotic lawnmowers.

The product's serial number consists of nine digits and is shown on the product rating plate (found on the inside of the display cover) and the product's packaging.

www.automower.com

1 Introduction and Security

1.1 Introduction

Congratulations on your choice of an exceptionally high quality product. To get the best results from your Husqvarna robotic lawnmower requires knowledge of how it works. This operator's manual contains important information about the robotic lawnmower, how it must be installed and how it is used.

As a complement to this Operator's Manual, there is more information available on the Automower® website, www.automower.se. Here you can find more help and guidance in its use.

Keep in mind that the operator is responsible for accidents or hazards occurring to other people or their property.

Husqvarna has a policy of continuous product development and therefore reserves the right to modify the design, appearance and function of products without prior notice.

The following system is used in the Operator's Manual to make it easier to use:

- Text written in *italics* is a text that is shown on the robotic lawnmower's display or is a reference to another section in the Operator's Manual.
- Words written in **bold** are one of the buttons on the robotic lawnmower's keypad.
- Words written in UPPERCASE and *italics* refer to the position of the main switch and the different operating modes available in the robotic lawnmower.

IMPORTANT INFORMATION

Please read the Operator's Manual carefully to understand the instructions before using the robotic lawnmower. Keep the operator's manual in a safe place for future reference!

This apparatus is not intended for use by persons (including children) with disabilities or lack of experience and knowledge. They may only use the apparatus under supervision or if they receive instructions of its use from a person responsible for their safety. Children must be kept under supervision in order to ensure they do not play with the apparatus.

www.automower.com



1001-003

INTRODUCTION AND SECURITY

RELEASE NOTES

This apparatus may be used by children over the age of eight years and people with disabilities or lack of experience and knowledge if they are kept under supervision or receive instructions of safe use of the apparatus and understand the risks involved with its use.

Children must not play with the apparatus. Cleaning and maintenance shall not be performed by children without supervision.



WARNING

The robotic lawnmower can be dangerous if used incorrectly.



WARNING

Never use the robotic lawnmower if any people, especially children, or pets, are in the immediate vicinity.

1.2 Symbols on the Product

These symbols can be found on the robotic lawnmower. Study them carefully.

- Please read the Operator's Manual carefully to understand the instructions before using the robotic lawnmower. The warnings and safety instructions in this Operator's Manual must be carefully followed if the robotic lawnmower is to be used safely and efficiently.
- The robotic lawnmower can only start when the main switch is set to 1 and the correct PIN code has been entered. Turn the main switch to 0 before carrying out any inspections and/or maintenance.
- Remain at a safe distance from the robotic lawnmower when it is running. Keep your hands and feet away from the rotating blades. Never put your hands or feet close to or under the mower body when it is running.

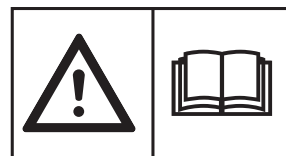

3018-173

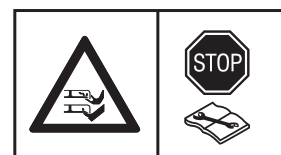

3018-174



3018-066

INTRODUCTION AND SECURITY

- Do not stand on the robotic lawnmower.
- This product complies with applicable EC directives.



3012-665



6001-024

- Noise emission to surroundings. This product's emissions are set out in chapter 10, Technical Data, and on the rating plate.



3012-1059

- It is not permitted to dispose of this product as normal household waste when it has reached the end of its useful life. Ensure that the product is recycled in accordance with local legal legislation.



3012-689

- Never use a high-pressure washer or even running water to clean the robotic lawnmower.

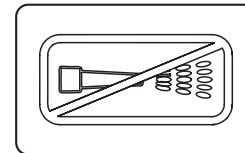

3018-062

- The chassis contains components which are sensitive to electrostatic discharge (ESD). The chassis is also a significant part of the robotic lawnmower's design and must be resealed in a professional manner if the product is to be used outdoors. For this reason the chassis can only be opened by authorized service technicians. A broken seal can result in the entire or parts of the guarantee no longer being valid.



3012-1097

- The low voltage cable must not be shortened, extended or spliced
- Do not use a trimmer in the vicinity of the low voltage cable. Take care when trimming lawn edges where the cable is placed.

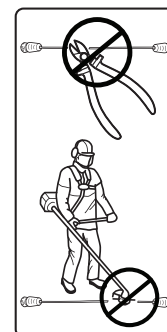

3012-1097

INTRODUCTION AND SECURITY

1.3 Symbols in the Operator's Manual

These symbols can be found in the Operator's Manual. Study them carefully.

- Turn the main switch to 0 before carrying out any inspections and/or maintenance.

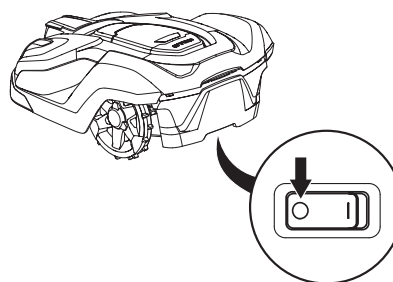

3012-1060

- Always wear protective gloves when working with the robotic lawnmower's chassis.



3012-272

- Never use a high-pressure washer or even running water to clean the robotic lawnmower.

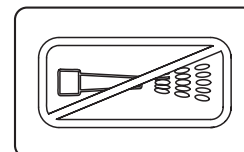

3018-062

- A warning box indicates the risk of personal injury, especially if the instructions are not followed.

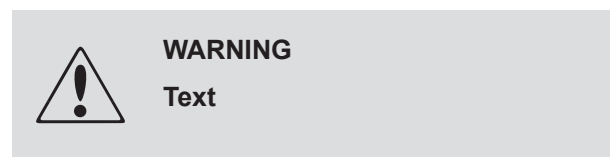

- An information box indicates the risk of material damage, especially if the instructions are not followed. The box is also used where there is a risk of user error.



1.4 Safety Instructions

Usage

- This robotic lawn mower is designed to mow grass on open and level ground areas. It may only be used with the equipment recommended by the manufacturer. All other types of use are incorrect. The manufacturer's instructions with regard to operation/maintenance and repair must be followed precisely.
- Use the **PARK** function or turn off the main switch on the robot mower if other people, especially children and pets, are nearby. If other people or pets are in the vicinity of the mowing area, we recommend programming the mower to use during periods when there are not people close by, e.g. at night. Refer to 6.3 *Timer page 43*.

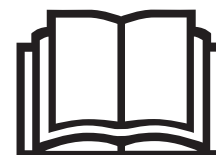

1001-003



INTRODUCTION AND SECURITY

- The robotic lawn mower may only be operated, maintained, and repaired by persons that are fully conversant with its special characteristics and safety regulations. Please read the Operator's Manual carefully and make sure you understand the instructions before using the robotic lawnmower.
- It is not permitted to modify the original design of the robotic lawnmower. All modifications are made at your own risk.
- Check that there are no stones, branches, tools, toys or other objects on the lawn that can damage the blades. Objects on the lawn can also lead to the robotic lawnmower getting stuck in them and help may be required to remove the object before the mower can continue mowing.
- Start the robotic lawnmower according to the instructions. When the main switch is in position 1, make sure you keep your hands and feet away from the rotating blades. Never put your hands and feet under the robotic lawnmower.
- Never lift up the robotic lawnmower or carry it around when the main switch is in position 1.
- Do not let persons who do not know how the robotic lawnmower works and behaves use it.
- The robot lawnmower must never be allowed to collide with people or other living beings. If a person or other living being comes into the path of the robot lawnmower, the lawnmower must be stopped immediately. Refer to 4.4 Stop page 35.
- Do not put anything on top of the robotic lawnmower or its charging station.
- Do not allow the robotic lawnmower to be used with a defective blade disc or body. Neither should it be used with defective blades, screws, nuts or wires.
- Do not use the robotic lawnmower if the main switch does not work.
- Always switch off the robotic lawnmower using the main switch when the robotic lawnmower is not in use. The robotic lawnmower can only start when the main switch is set to 1 and the correct PIN code has been entered.
- The robotic lawnmower must never be used at the same time as a sprinkler. In this case use the timer function, see 6.3 *Timer* page 43, so the mower and sprinkler never run simultaneously.
- Husqvarna does not guarantee full compatibility between the robotic lawnmower and other types of wireless systems such as remote controls, radio transmitters, hearing loops, underground electric animal fencing or similar.
- The integrated alarm is very loud. Take care, especially if the robot lawnmower is handled indoors.

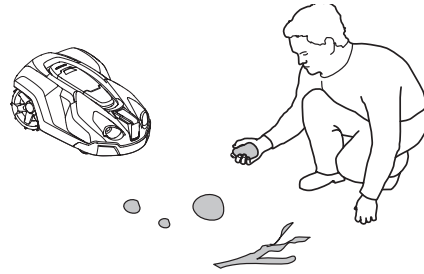

3012-1057



3012-663





INTRODUCTION AND SECURITY

Moving Around

The original packaging should be used when transporting the robotic lawnmower over long distances.

To safely move from or within the working area:

1. Press the **STOP** button to stop the robotic lawnmower. If security is set to the medium or high level (see 6.5 Security on page 47.), the PIN code has then to be entered. The PIN code contains four digits and is selected when you start the robotic lawnmower for the first time, see 3.8 First Start-up and Calibration on page 32.
2. Set the main switch in 0 position.

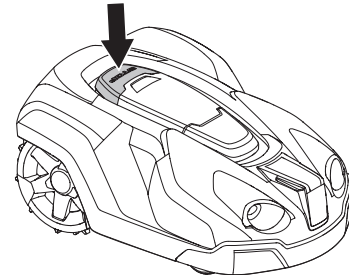

3012-1044

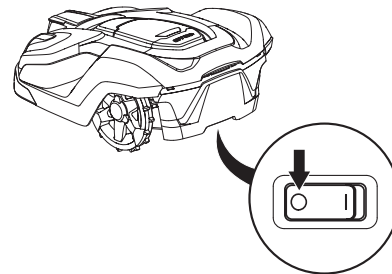

3012-1060

3. Carry the robotic lawnmower by the handle found at the rear of the product. Carry the robotic lawnmower with the blade disc away from the body.



3012-1203

IMPORTANT INFORMATION

Do not lift the robotic lawnmower when it is parked in the charging station. It can damage the charging station and/or the robotic lawnmower. Press STOP and instead first pull the robotic lawnmower out of the charging station before lifting it.



INTRODUCTION AND SECURITY

Maintenance



WARNING

When the robotic lawnmower is turned upside down the main switch must always be in the 0 position.

The main switch should be set in the 0 position during all work on the mower's chassis, such as cleaning or replacing the blades.

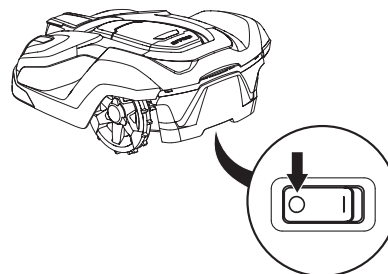

3012-1060

IMPORTANT INFORMATION

Never use a high-pressure washer or even running water to clean the robotic lawnmower. Never use solvents for cleaning.

Inspect the robotic lawnmower each week and replace any damaged or worn parts. The following must be carried out in the weekly inspections:

- Clean the charging station from grass, leaves, twigs and other objects that may impede the robotic lawnmower from docking with the charging station.
- Set the main switch to position 0 and put on a pair of protective gloves. Turn the robotic lawnmower upside down. Check the following:
 1. Clean the drive wheels. Grass in the drive wheels can impact on how the lawnmower works on slopes.
 2. Clean the front wheels. Grass on the front wheels and the front wheel axles can affect performance.
 3. Clean the body, chassis and cutting system. Grass, leaves and other objects that weigh down the product affect performance.
 4. Check that all mower blades are intact. Check also that the blades can pivot freely. Even if the mower blades are intact, they must be replaced on a regular basis for the best mowing result and low energy usage. Replace all blades and screws at the same time if necessary to keep the rotating parts balanced see 8.7 *Blades* on page 78.

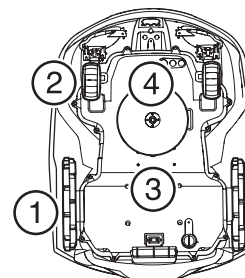

3012-1257



PRESENTATION

2 Presentation

This chapter contains information that is important to be aware of when planning the installation.

Installing a Husqvarna robotic lawnmower involves four main components:

- A robotic lawnmower that mows the lawn by essentially operating in a random pattern. The robotic lawnmower is powered by a maintenance-free battery.
- A charging station, to where the robotic lawnmower returns when the charge level in the battery becomes too low.

The charging station has three functions :

- To send control signals along the boundary wire.
 - To send control signals along the guide wires.
 - To charge the battery in the robotic lawnmower.
-
- The power supply, which is connected between the charging station and a 100V-230V wall socket. The power supply is connected to the wall socket and to the charging station using a 10 m long low voltage cable. The low voltage cable must not be shortened or extended.

A longer low voltage cable is available as optional accessory. Contact your local dealer for more information.

- A search wire, laid in a loop around the robotic lawnmower's working area. The loop wire is laid around the edges of the lawn and around objects and plants that the robotic lawnmower must not run into. The loop wire is also used as the guide wire.

The maximum permitted length for the boundary loop is 800 m.

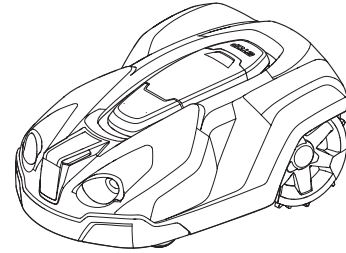

3012-1040

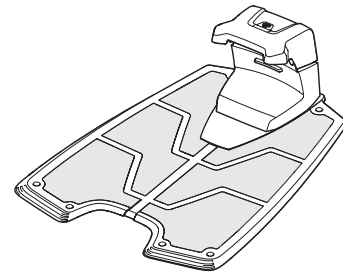

3012-1041

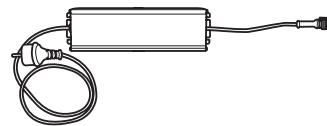

3012-1352

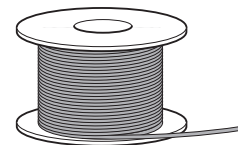

3012-221

IMPORTANT INFORMATION

Search wires, pegs, couplers and connectors are available in a separate installation kit.

Always use original spare parts



PRESENTATION

2.1 What's What?

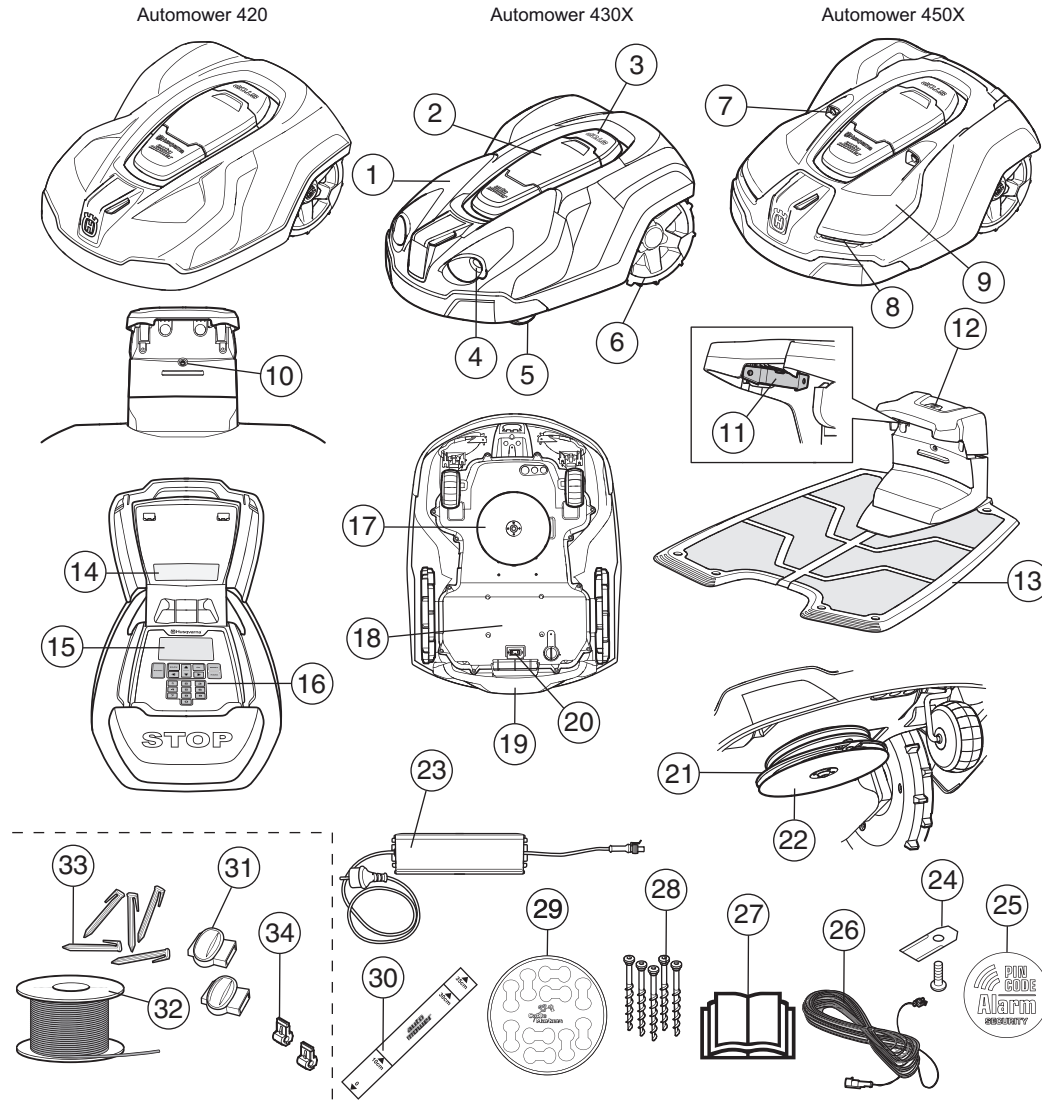

The numbers in the picture correspond to:

- | | |
|---|---|
| 1. Body | 18. Chassis box with electronics, battery and motors |
| 2. Cover for display and keypad. | 19. Handle |
| 3. Stop button/Locking button to open the cover | 20. Main switch |
| 4. Fixture for accessories, e.g. headlights (only Automower 430X) | 21. Blade disc |
| 5. Front wheels | 22. Skid plate |
| 6. Rear wheels | 23. Power supply |
| 7. Ultrasonic sensors | 24. Extra blades |
| 8. Headlights | 25. Alarm decal |
| 9. Exchangeable casing | 26. Low voltage cable |
| 10. LED for checking the function of the charging station, boundary wire and guide wire | 27. Operator's manual and QuickGuide |
| 11. Contact strip | 28. Screws for securing the charging station |
| 12. Parking button (not Automower® 420) | 29. Cable markers |
| 13. Charging station | 30. Measurement gage for help when installing the boundary wire (the measurement gage is broken loose from the box) |
| 14. Rating plate | 31. Couplers for the search wire * |
| 15. Display | 32. Loop wire for boundary loop and guide wire * |
| 16. Keypad | 33. Pegs * |
| 17. Cutting system | 34. Connectors for the search wire * |

* Included with Installation Kit, not included in the purchase of the robotic lawnmower

3012-566

PRESENTATION

2.2 Package Contents

Your Automower® package contains the following details.

Robotic lawnmowers	√
Charging station	√
Power supply	√
Low voltage cable	√
Charging station screws	6 pc
Allen key	√
Operator's Manual and Quick Guide	√
Extra blades	9 pc
Alarm decal	√
Cable markers	√
Measurement gage	√

2.3 Function

Capacity

The robotic lawnmower is recommended for lawn areas up to:

	420	430X	450X
Grass area, m² / acre	2 200 / 0.55	3 200 / 0.8	5 000 / 1.25

The size of the area which the robotic lawnmower can keep cut depends primarily on the condition of the blades and the type, growth and moisture of the grass. The shape of the yard is also significant. If the yard mainly consists of open lawn areas, the robotic lawnmower can mow more per hour than if the yard consists of several small lawns separated by trees, flower beds and passages.

The cutting time of the robotic lawnmower depends on the age of the battery and the thickness of the grass. The charging time can vary depending on, among other factors, the ambient temperature.

	420	430X	450X
Cutting Time, min	90-110	120-150	230-270
Charge Time, min	50-70	60-80	70-90



PRESENTATION

Cutting Technique

The cutting system in the Husqvarna robotic lawnmower is based on an efficient and energy saving principle. Unlike many standard lawnmowers, the robotic lawnmower cuts the grass instead of scything it off.

We recommend you allow the robotic lawnmower to mainly mow in dry weather to obtain the best possible result. Husqvarna's robotic lawnmowers can also mow in the rain, however, wet grass easily sticks on the robotic lawnmower and there is a greater risk of slipping on steep slopes.

The blades must be in good condition to obtain the best mowing result. In order to keep the blades sharp for as long as possible it is important to keep the lawn free from branches, small stones and other objects.

Replace the blades regularly for the best mowing result. It is very easy to replace the blades. Refer to *8.7 Blades page 78*.

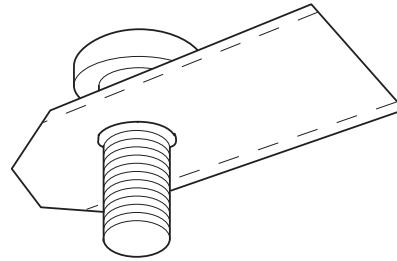

3020-002

Working Method

The robotic lawnmower automatically mows the lawn. It continuously alternates between mowing and charging.

The robotic lawnmower starts to search for the charging station when the battery charge becomes too low. The robotic lawnmower does not mow when it is searching for the charging station.

While searching for the charging station, the robot lawnmower can find it in a number of different ways, see *Finding the Charging Station on page 14*.

Once the battery is fully charged, the robot lawnmower will leave the charging station and start to mow an area of lawn where it has not recently been. This area will be determined by the GPS receiver. This functionality applies to Automower® 430X and Automower® 450X.

Manual exit settings may be needed on the Automower® 420 in order to ensure the lawn is evenly mown, see *6.8 Installation on page 51*.

When the robotic lawnmower body hits an obstacle, the robotic lawnmower reverses and selects a new direction.

Sensors at the front and back will sense when the robotic lawnmower is approaching the boundary wire. The robotic lawnmower travels up to 32 cm / 13 " beyond the wire before it turns around.

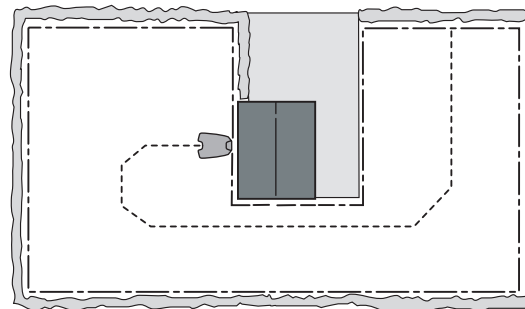

3023-003

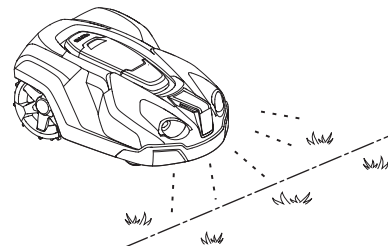

3012-1043



PRESENTATION

The STOP button on top of the robotic lawnmower is mainly used to stop the mower when it is running. When the **STOP** button is pressed a hatch opens, behind which there is a control panel. The **STOP** button remains depressed until the cover is closed again. This, together with the **START** button acts as a start inhibitor.

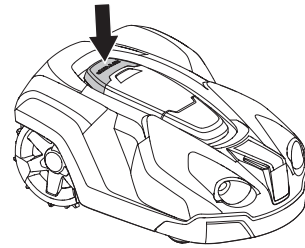

3012-1044

The control panel on the top of the robotic lawnmower is where you manage all the robotic lawnmower settings.

When the main switch is set to position 1 for the first time, a start-up sequence begins which includes a number of important basic settings, see 3.8 *First Start-up and Calibration* on page 32.



3012-1094

Movement Pattern

The movement pattern of the robotic lawnmower is irregular and is determined by the robotic lawnmower itself depending on the appearance of the lawn. The mower does not always mow in straight lines and one movement pattern is never repeated either. With this cutting system the lawn is mown without any mowing lines after the robotic lawnmower.

If the robotic lawnmower enters an area where it senses the grass is longer than average, it can change the movement pattern. It can then mow in a spiral pattern to faster cut the area of longer grass. This is known as spiral cutting.

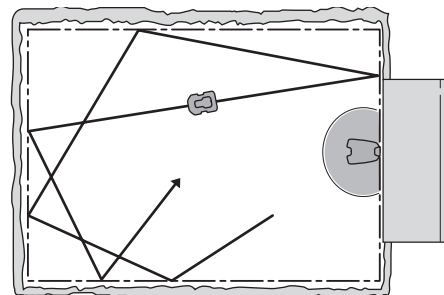

3023-034

Finding the Charging Station

The robotic lawnmower can be set to search for the charging station in one or more of three different ways. The robotic lawnmower automatically combines these three search methods to locate the charging station as fast as possible but also to avoid as many tracks forming as possible.

Using the manual settings options, the three search methods can be combined to optimize the search for the charging station for the shape of the yard in question, see *Installation* on page 16.

Search method 1: Irregular

The robotic lawnmower operates irregularly until it gets close to the charging station.

The benefit with this search method is that there is no risk of tracks on the lawn from the robotic lawnmower. The disadvantage is that search times can be somewhat long.

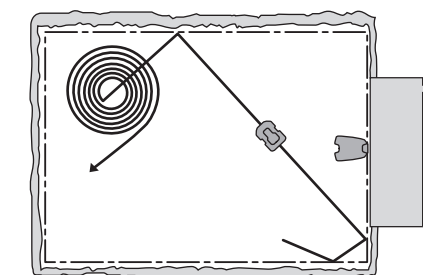

3023-041

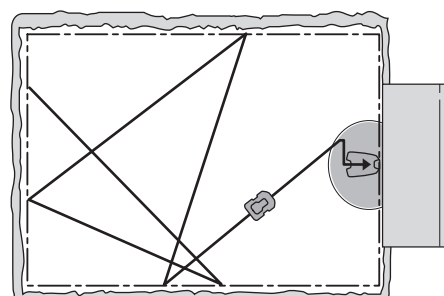

3023-035



PRESENTATION

Search method 2: Follow guide wire

The robotic lawnmower runs irregularly until it reaches the guide wire. Then the robotic lawnmower follows the guide wire to the charging station.

The guide wire is an extra wire that is laid from the charging station towards a remote part of the working area or through a narrow passage to be then connected with the boundary wire, see 3.6 *Installation of Guide Wire* on page 28.

Automower® 450X can have up to three guide wires and Automower® 430X up to two guide wires. Automower® 420 has only one guide wire.

This search method makes it easier for the robotic lawnmower to find the charging station beyond many or large islands, narrow passages or steep slopes.

The benefit of this search method is shorter search times.

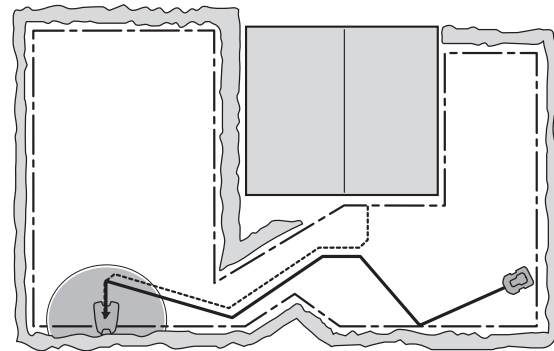

3012-558

Search method 3: Follow boundary wire

The robotic lawnmower operates irregularly until it reaches the boundary loop. Then it follows the boundary loop to the charging station. The robotic lawnmower randomly selects to travel clockwise or anticlockwise.

This search method is suitable in an installation with an open lawn space, wide passages (wider than about 3 m / 10 ft) and no or only a few small islands.

The benefit of this search method is that there is no need to install a guide wire.

The disadvantage is that some tracks can be formed in the lawn alongside the boundary loop. The search time will also be longer if there are narrow passages or numerous islands in the installation.

As a rule, this search method is used only if the robotic lawnmower can not find the charging station using search method 1 or 2 within the expected time period.

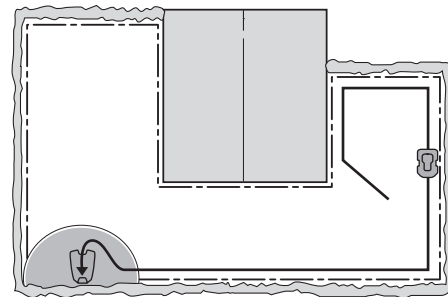

3012-486



INSTALLATION

3 Installation

This chapter describes how to install the robotic lawnmower. Read the previous chapter 2. *Presentation* before starting the installation.

Read also through this entire chapter before beginning the installation. How the installation is done also affects how well the robotic lawnmower works. It is therefore important to plan the installation carefully.

Planning is simplified if you make a sketch of the working area, including all obstacles. This makes it easier to see the ideal positions for the charging station, the boundary wire and the guide wire. Draw on the sketch where the boundary and guide wires should be routed.

For examples of installations, see 7 *Yard Examples on page 69*.

Visit also www.automower.com for further descriptions and tips regarding installation.

Carry out the installation in the following steps:

- 3.1 Preparations
- 3.2 Installation of the charging station
- 3.3 Charging the battery
- 3.4 Installation of the boundary wire
- 3.5 Connecting the boundary wire
- 3.6 Installation of the guide wire
- 3.7 Checking the installation
- 3.8 First start-up and calibration
- 3.9 Test docking with the charging station

The charging station, boundary loop and guide wire must be connected to be able to carry out a complete start-up.

3.1 Preparations

1. If the grass in the working area is higher than 10 cm / 4", mow it using a standard lawnmower. Then collect the clippings.
2. Fill in holes and hollows to stop rainwater collecting in puddles. The product may be damaged if it is operated in puddles, see 11 *Warranty Terms on page 92*.
3. Read carefully through all the steps before the installation.

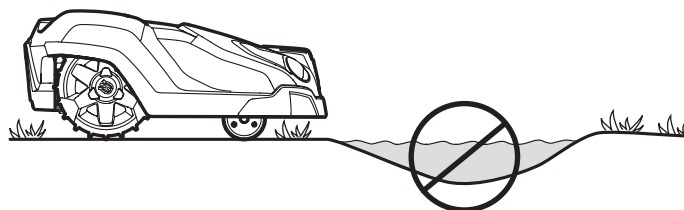

3012-1101

INSTALLATION

4. Check that all parts for the installation are included. Numbers in parentheses refer to the contents image, see *2.1 What's What? on page 11*.

- Robotic lawnmowers
- Charging station (13)
- Search wire for boundary wire and guide wire (32)
- Power supply (23)
- Low voltage cable (26)
- Pegs (33)
- Connectors for the search wire (34)
- Screws for the charging station (28)
- Measurement gage (30)
- Couplers for search wire (31)
- Cable markers (29)

During installation you will also need:

- Hammer/plastic mallet to simplify putting the pegs in the ground)
- Combination pliers for cutting the boundary wire and pressing the connectors together.
- Universal pliers (for pressing couplers to each other).
- Edge cutter/straight spade (if the boundary wire must be buried).

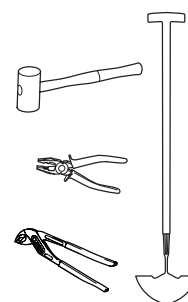

3.2 Installation of Charging Station

3018-057

Ideal position for charging station

Take the following aspects into consideration when identifying the best location for the charging station:

- Allow for at least 3 m / 10 ft of free space in front of the charging station
- Close to a wall socket. The supplied low voltage cable is 10 m / 33 ft long.
- A level surface to place the charging station on
- Protection from water spray for instance from sprinklers
- Protection from direct sunlight
- Possible requirement to keep the charging station out of sight for outsiders

INSTALLATION

The charging station must be positioned with a great deal of free space in front of it (at least 3 m / 10 ft). It should also be centrally placed in the working area to make it easier for the robotic lawnmower to reach all areas in the working area.

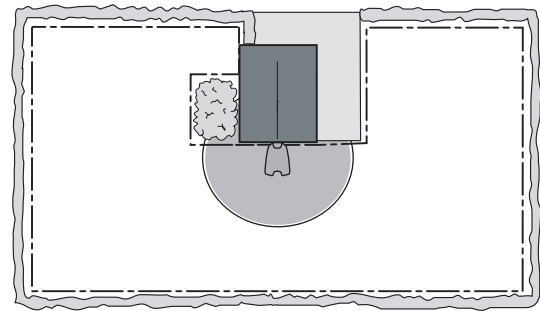

3023-038

Do not put the charging station in confined spaces in the working area. This can make it difficult for the robotic mower to find the charging station.

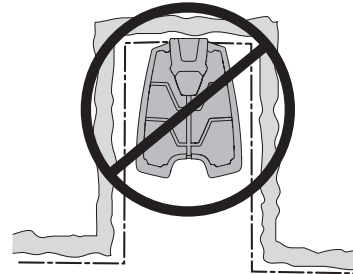

3012-555

The charging station must be positioned on relatively level ground. The front end of the charging station may be a maximum of 5 cm / 2 " higher or lower than the back end.

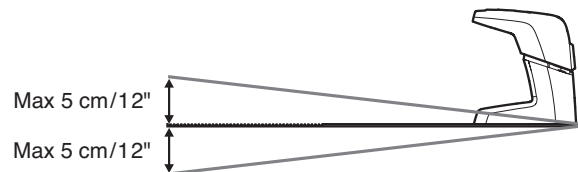

3012-1054

The charging station must not be positioned so that its plate bends.

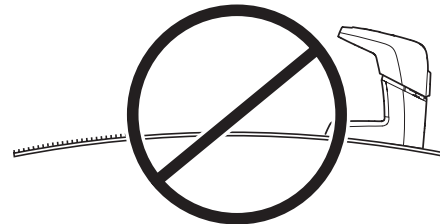

3012-1053

Connection of Power Supply

Take the following into consideration when planning where to place the power supply:

- Close to the charging station
- Protection from rain
- Protection from direct sunlight

If the power supply is connected to an electrical socket outdoors, it must be approved for outdoor use.

The low voltage cable for the power supply is 10 m / 33 ft long, and may not be shortened or extended. A longer low voltage cable is available as optional accessory. Contact your local dealer for more information.

It is not allowed to connect the power supply directly to the charging station. The low voltage cable must always

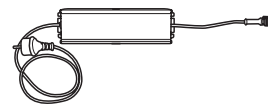

3012-1352

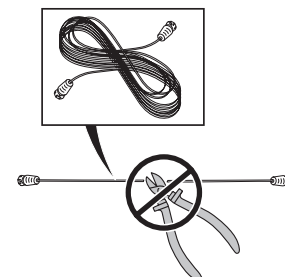

3018-069

INSTALLATION

be used.

IMPORTANT INFORMATION

The low voltage cable must not under any circumstances be shortened or extended.

It is possible to let the low voltage cable cross the working area. The low voltage cable must be pegged down or buried, and the cutting height should be such that the blades on the blade disc can never come in contact with the low voltage cable.

Make sure to lay the low voltage cable along the ground, fastened with pegs. The cable must lie close to the ground so as not to be cut before the grass roots have grown over it.

The low voltage cable must never be stored coiled up or lie under the charging station bottom plate as it may cause signal interference from the charging station.

IMPORTANT INFORMATION

Place the low voltage cable so that the blades on the blade disc can never come in contact with it.

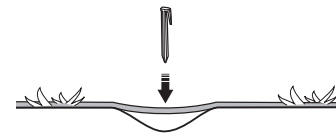

3018-085

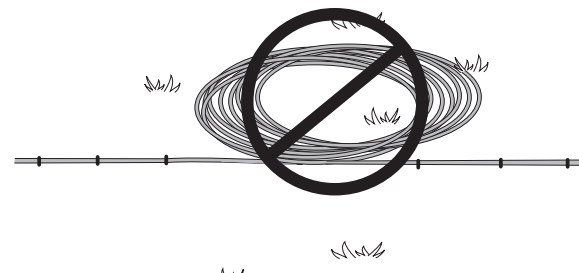

3018-085

The power supply must be placed where it is well ventilated and is not exposed to direct sunlight. The power supply should be placed under a roof.

It is recommended to use an earth fault-breaker when connecting the power supply to the wall socket.

The power supply must be mounted on a vertical surface, such as a wall or a fence. Screw the power supply in place with screws in the two mounting eyelets. No screws are supplied. Select screws suitable for the material in question.

Do not, under any circumstances, mount the power supply at a height where there is a risk it can be submerged in water (at least 30 cm / 12" from the ground). It is not permitted to place the power supply on the ground.

Never connect the power supply to an electrical socket if the cable or the connector is damaged. Damaged or entangled cords increase the risk of electric shock.

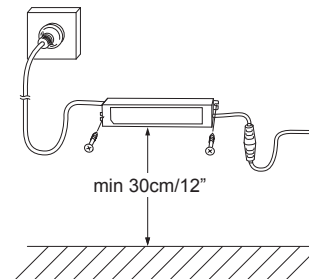

3018-094

IMPORTANT INFORMATION

Use the power supply plug to shut down the charging station, for instance before cleaning or repairing the search wire.

INSTALLATION

Installation and Connection of the Charging Station

1. Position the charging station in a suitable spot.
2. Tilt the protective cover on the charging station forward and connect the low voltage cable to the charging station.
3. Connect the power supply's power cord to a 100-240V wall socket.

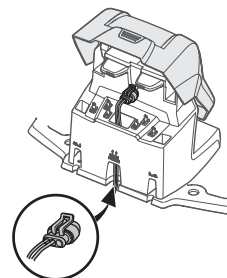
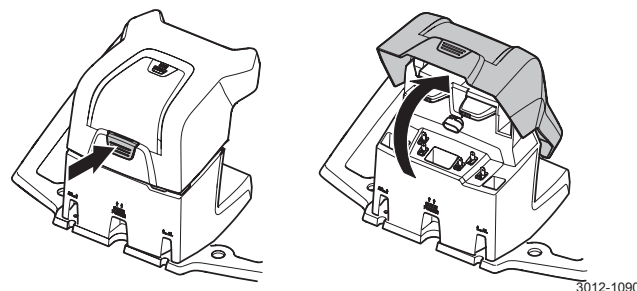

4. Fasten the charging station to the ground using the supplied screws. Ensure the screws are screwed all the way down in the countersink. If the charging station is placed against a wall, it is best to wait before securing the charging station to the ground until after all the wires have been connected.

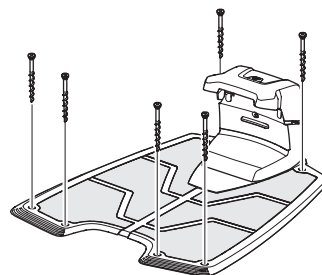

IMPORTANT INFORMATION

It is not permitted to make new holes in the charging station's plate. Only the existing holes may be used to secure the base plate to the ground.

IMPORTANT INFORMATION

Do not tread or walk on the charging station plate.



3.3 Charging the Battery

As soon as the charging station is connected, it is possible to charge the robotic lawnmower. Set the main switch in position 1.

Place the robotic lawnmower in the charging station to charge the battery while the boundary and guide wires are being laid.

If the battery is flat, it will take around 80 to 100 minutes to fully recharge it.

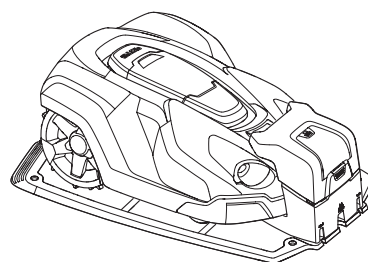

IMPORTANT INFORMATION

The robotic lawnmower cannot be used before the installation is complete.

INSTALLATION

3.4 Installation of Boundary Wire

Ensure correct installation of the boundary wire according to directions.

The boundary wire can be installed in one of the following ways:

- Secure the wire to the ground with pegs.

It is preferable to peg down the boundary wire if you want to make adjustments to the boundary wire during the first few weeks of operation. After a few weeks the grass will have grown over the wire making it no longer visible. Use a hammer/plastic mallet and the pegs supplied when carrying out the installation.

- Bury the wire.

It is preferable to bury the boundary wire if you want to dethatch or aerate the lawn. If necessary, both methods can be combined so one part of the boundary wire is pegged down and the remainder is buried. The cable can be buried using for instance an edge cutter or a straight spade. Make sure to lay the boundary wire at least 1 cm / 0.4 " and a maximum of 20 cm / 8 " in the ground.

Plan where to lay the boundary wire

The boundary wire must be laid so that:

- The wire forms a loop around the working area for the robotic lawnmower. Only Husqvarna boundary wire must be used. It is specially designed to resist dampness from the soil that could otherwise easily damage the wires.
- The robotic lawnmower is never more than 35 m / 115 ft from the wire at any point in the entire working area.
- The wire can not be more than 800 m / 2 600 ft long.
- 20 cm / 8 " of extra wire is available to which the guide wire will be connected later. Refer to 3.6 *Installation of Guide Wire* page 28.

Depending on what the working area is adjacent to, the boundary wire must be laid at different distances from obstacles. The illustration below shows how the boundary wire must be laid around the working area and around obstacles. Use the supplied measurement gage to obtain the correct distance, see 2.1 *What's What?* on page 11.

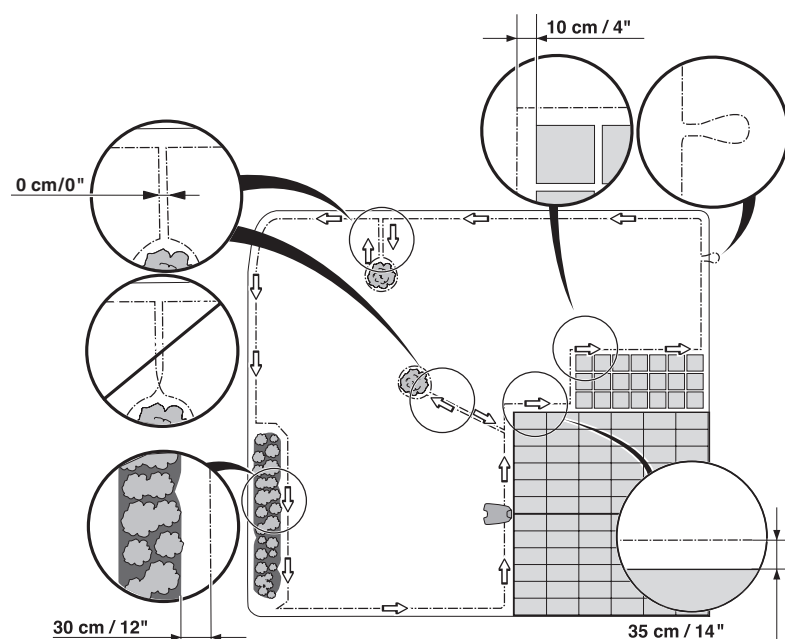

3023-031

English - 21



INSTALLATION

Working Area Boundaries

If a high obstacle (5 cm / 2 " or more), for example a wall or fence, borders the working area, the boundary wire should be laid 35 cm / 13.8 " from the obstacle. This will prevent the robotic lawnmower from colliding with the obstacle and reduce body wear.

About 20 cm / 8 " around the fixed obstacle will not be mown.

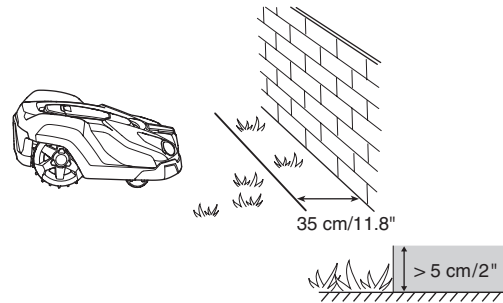

3012-1115

If the working area borders on a small ditch, for example a flower bed, a small elevation or a low kerbstone (1-5 cm / 0.4-2 "), the boundary wire should be laid 30 cm / 12 " inside the working area. This will prevent the wheels going into the ditch or up onto the kerb, which can cause extensive damage to the robot lawnmower, especially the front wheels.

About 15 cm / 6 " of the lawn along the ditch/kerbstone will not be mown.

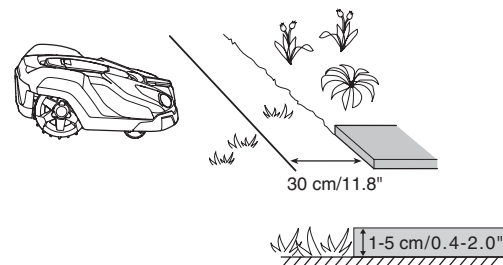

3012-1116

If the working area borders on a paving stone path or similar which is level with the lawn (+/- 1 cm / 0.4 "), it is possible to allow the robotic lawnmower to run a little over the path. The boundary wire should then be laid 10 cm / 4 " from the edge of the path.

All the grass along the side of the path will be cut.

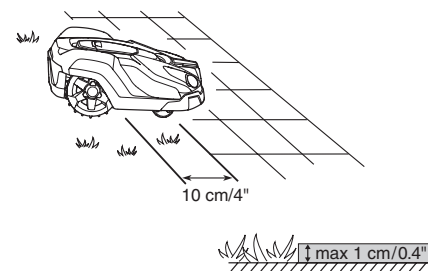

3012-1117

When the working area is divided by a paving stone path that is level with the lawn, it is possible to allow the robotic lawnmower to run over the path. It can be an advantage to lay the boundary wire under the paving stones. The boundary wire can also be laid in the joint between the paving stones. Make sure the paving stones are level with the lawn to avoid unnecessary wear on the robotic lawnmower.

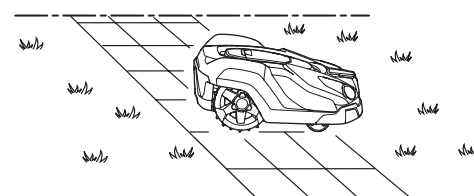

3012-1118

Note: The robotic lawnmower must never run over gravel, mulch or similar material which can damage the blades.

IMPORTANT INFORMATION

If the working area is adjacent to bodies of water, slopes, precipices or a public road, the boundary wire must be supplemented with edging or the like. The height must then be at least 15 cm / 6 ". This will prevent the robotic lawnmower from ever ending up outside the working area.

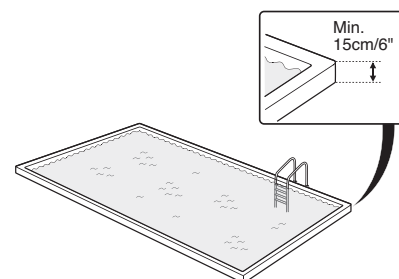

3016-046



INSTALLATION

Boundaries Within the Working Area

Use the boundary wire to demarcate areas inside the working area by creating islands around obstacles which can not withstand a collision, for example flowerbeds, bushes and fountains. Lay the wire up to and around the area to be demarcated, and then return it back along the same route. If pegs are used, the wire should be laid under the same peg on the return route. When the boundary wires to and from the island are laid close together, the robotic lawnmower can drive over the wire.

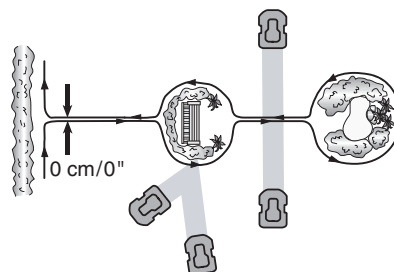

3012-1073

IMPORTANT INFORMATION

The boundary wire may not be crossed on its way to and from an island.

Obstacles that can withstand a collision, for example trees and bushes higher than 15 cm / 6", do not need to be demarcated by the boundary wire. The robotic lawnmower will turn when it collides with this type of obstacle.

It is recommended to isolate all fixed objects in and around the working area. This results in the most gentle and silent operation and prevent the robotic lawnmower from getting stuck in the objects under any circumstances.

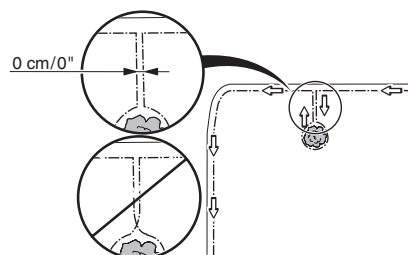

3012-686

Obstacles that slope slightly, for example stones or large trees with raised roots, must be isolated or removed. Otherwise the robotic lawnmower can slide up onto this kind of obstacle causing the blades to be damaged.

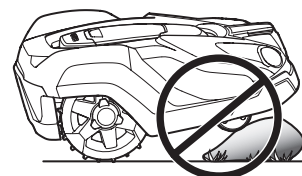

3012-1064

Secondary Areas

If the working area consists of two areas which the robotic lawnmower has difficulty traveling between, it is recommended to set up a secondary area. Instances of this are 45 % slopes or a passage that is narrower than 60 cm / 24". Then lay the boundary wire around the secondary area so that it forms an island outside the main area.

The robotic lawnmower must be moved manually between the main and secondary area when the lawn in the secondary area has to be cut. Since the robotic lawnmower is not able to get to the charging station by itself from a secondary area, *Secondary area (A) operating mode* must be used, see 5.1 *Operating Mode Start* on page 38.

The robotic lawnmower will then not start searching for the charging station but use its entire capacity to mow. When the battery is flat, the robotic lawnmower will stop and the *Needs manual charging* message will appear in the display. Then place the robotic lawnmower in the charging station to charge the battery. If the main area is to be cut straight after charging, the **START** button must be pressed and the *Main area (A)* selected before closing the hatch.

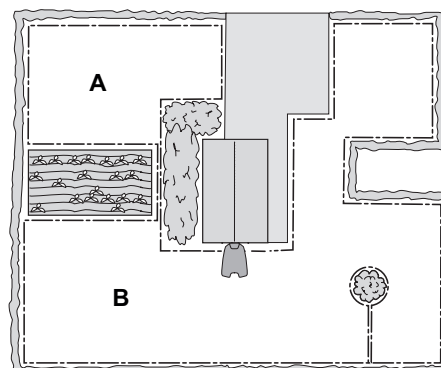

3012-563

INSTALLATION

Passages When Mowing

Long and narrow passages and areas narrower than 1.5 - 2 m / 3.3 - 6.6 ft should be avoided. When the robotic lawnmower mows there is a risk that it will move around in the passage or area for too long. The lawn will then look flattened.

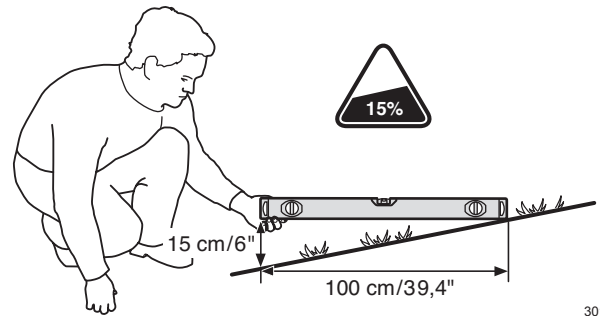

3012-1119

Slopes

The robotic lawnmower can also operate on sloping working areas. The maximum gradient is defined as percentage units (%). The slope as a percentage is calculated as the difference in elevation in centimeters for every meter. If for instance the difference in elevation is 15 cm / 6", the slope gradient is 15 %. See the adjacent picture.

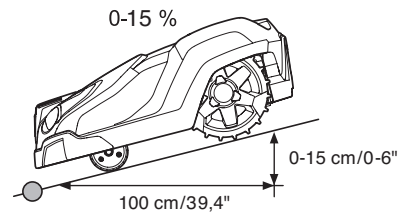

3012-1120

The boundary wire can be laid across a slope that has a gradient of less than 15 %.

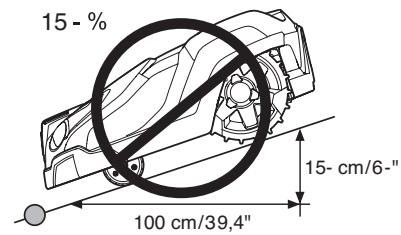

3012-1121

The boundary wire should not be laid across a slope that is steeper than 15 %. There is a risk that the robotic lawnmower will find it difficult to turn there. The robotic lawnmower will then stop and the *Outside working area* fault message is displayed. The risk is at its greatest in damp weather conditions, as the wheels can slip on the wet grass.

However, the boundary wire can be laid across a slope steeper than 15 % if there is an obstacle that the robotic lawnmower is allowed to collide with, for example, a fence or a dense hedge.

Inside the working area the robotic lawnmower can mow areas which slope up to 45 %. Areas that slope more must be demarcated by the boundary wire.

When a part of the working area's outer edge slopes more than 15 %, the boundary wire must be laid about 35 cm / 13.8" in on the flat ground before the beginning of the slope.

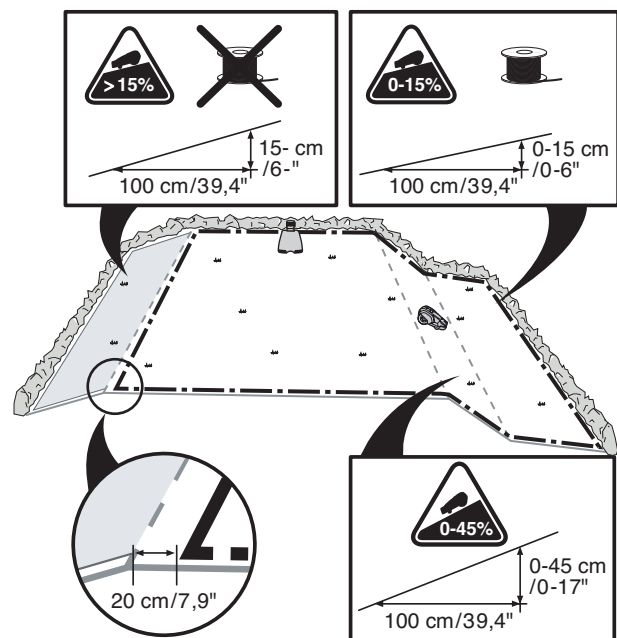

3012-1122

INSTALLATION

Laying the Boundary Wire

If you intend to peg down the boundary wire:

- Cut the grass very short with a standard lawn mower or a trimmer where the wire is to be laid. It will then be easier to lay the wire close to the ground and the risk of the robotic lawnmower cutting the wire or damaging the insulation of the wire is reduced.
- Make sure to lay the boundary wire close to the ground and secure with pegs. The cable must lie close to the ground so as not to be cut before the grass roots have grown over it.
- Use a hammer to knock the pegs into the ground. Exercise care when knocking in the pegs and make sure the wire is not under strain. Avoid sharp bends in the wire.

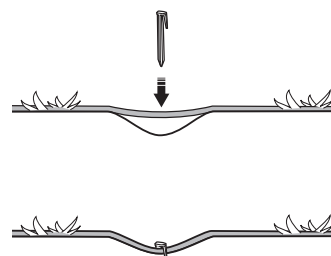

3018-085

If the boundary wire is to be buried:

- Make sure to lay the boundary wire at least 1 cm / 0.4 " and a maximum of 20 cm / 8 " in the ground. The cable can be buried using for instance an edge cutter or a straight spade.

Use the supplied measurement gage as a guide when you lay out the boundary wire. This helps you to easily set the correct distance between the boundary wire and the boundary/obstacle. The measurement gage is broken loose from the box.

IMPORTANT INFORMATION

Extra wire must not be placed in coils outside the boundary wire. This can disrupt the robotic lawnmower.

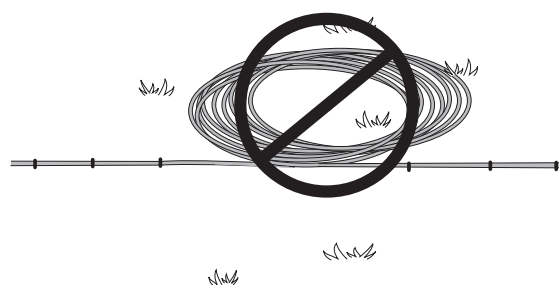

3012-281

Loop for connecting the guide wire

To facilitate the connection of the guide wire to the boundary wire, it is recommended to wind a ring with about 20 cm / 8 " of extra boundary wire at the point where the guide wire will later be connected. It is a good idea to plan where the guide wire will be placed before laying out the boundary wire. Refer to *3.6 Installation of Guide Wire* page 28.

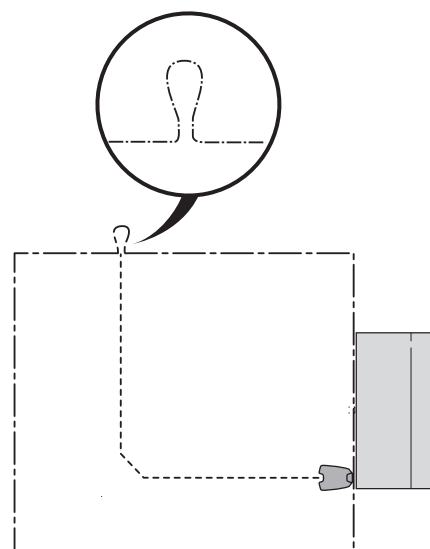

3023-007

English - 25



INSTALLATION

Laying the boundary wire in towards the charging station

On its way toward the charging station, the boundary wire can be laid completely outside the charging station (see option 1 in the figure). If there is a need to partly locate the charging station outside the working area, it is also possible to lay the wire under the charging station plate (see option 2 in the figure).

However most of the charging station must not be placed outside the working area as the robotic lawnmower can then find it difficult to find the charging station (see figure).

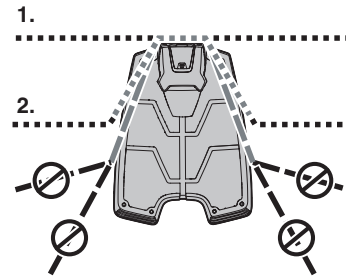

3012-1065

Splicing the boundary wire

Use an original coupler if the boundary wire is not long enough and needs to be spliced. It is waterproof and gives a reliable electrical connection.

Insert both cable ends in the coupler. Make sure the wires are fully inserted in the coupler by checking that the ends are visible through the transparent area on the opposite side of the coupler. Now fully press down the button on top of the connector. Use pliers to completely depress the button on the connector.

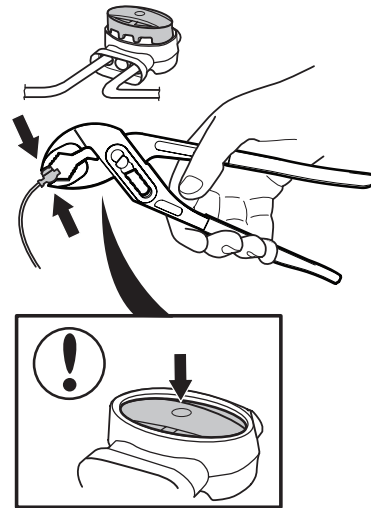

3018-055

IMPORTANT INFORMATION

Twinned cables, or a screw terminal block that is insulated with insulation tape are not satisfactory splices. Soil moisture will cause the wire to oxidize and after a time result in a broken circuit.





INSTALLATION

3.5 Connecting the Boundary Wire

Connect the boundary wire to the charging station:

IMPORTANT INFORMATION

The boundary wire must not be crossed when connecting to the charging station. The right hand wire end must be connected to the right hand pin on the charging station and the left hand wire end to the left pin.

- Place the cable ends in the connector:
 - Open the connector.
 - Place the wire in the connector grip.
- Press together the connectors with a pair of pliers. Press until you hear a click.
- Cut off any surplus boundary wire. Cut 1-2 cm / 0.4 - 0.8 " above each connector.
- Tilt the protective cover on the charging station forward and run the wire ends up each channel at the rear of the charging station. Press the connector onto the contact pin, marked AL (left) and AR (right), on the charging station.
- Mark the wires with the accompanying wire labels. This makes it easier to reconnect the wires correctly when for instance the charging station has been stored indoors for the winter.

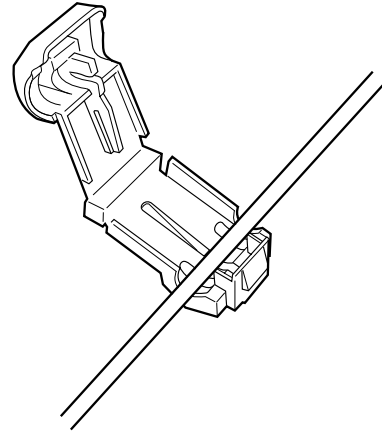

3012-284

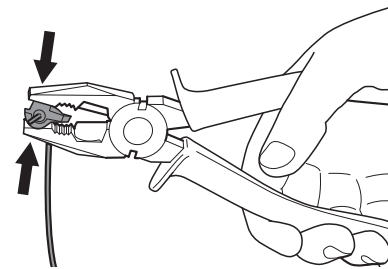

3012-264

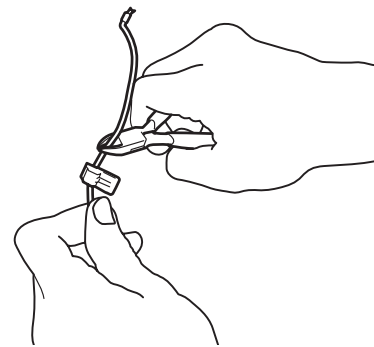

3012-265

IMPORTANT INFORMATION

The right hand connector must be connected to the right hand contact pin on the charging station and the left hand wire end to the left connector.

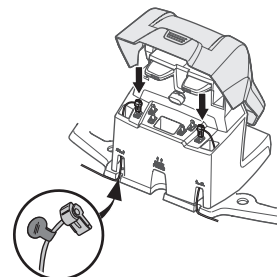

3012-1091





INSTALLATION

3.6 Installation of Guide Wire

The guide wire is a wire that is laid away from the charging station, for instance out towards a remote part of the working area or through a narrow passage and then connected with the boundary wire. The same wire is used for both the boundary and guide wires.

The guide wire is used by the robotic lawnmower to find its way back to the charging station but also to guide the robotic lawnmower to hard-to reach areas of the yard.

Automower® 450X can have up to three guide wires and Automower® 430X up to two guide wires. Automower® 420 has only one guide wire.

Run the robotic lawnmower at varying distances from the guide wire to reduce the risk of tracks forming. The area beside the wire which the robotic lawnmower then uses is called the Corridor. The wider the corridor allowed by the installation, the less the risk of tracks forming. When installing, it is therefore important to create as much free space as possible along the guide wire.

The robotic lawnmower always runs to the left of the guide wire as seen facing the charging station. The grass corridor is then to the left of the guide wire. When installing, it is therefore important to create as much free space as possible to the left of the guide wire, as seen facing the charging station. It is not allowed to lay the guide wire closer than 30 cm / 12 " from the boundary wire.

The guide wire, as the boundary wire, can be pegged to or buried in the ground.

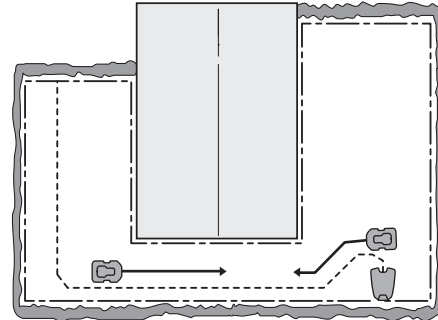

3023-008

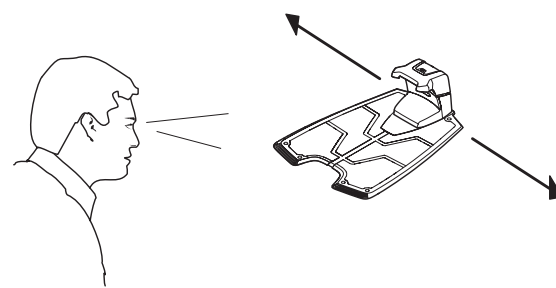

3012-1100

IMPORTANT INFORMATION

Make sure to have as much free space as possible to the left of the guide wire, as seen facing the charging station.



INSTALLATION

Laying and connecting the guide wire

1. Before laying and connecting the guide wire, it is important to give consideration to the length of the guide loop, especially in large or complex installations. If the guide loop is longer than 400 m / 1 300 ft, the robotic lawnmower can have difficulty following the guide wire.

The guide wire, together with the part of the boundary loop that comprises the return to the charging station, is called the guide loop. The signal in the guide loop always goes to the left at the connection from the guide wire to the boundary wire. The two figures here display what is regarded as a guide loop. The figures are also a good example of how the guide loop in an working area can have very varying lengths depending on where the charging station is placed.

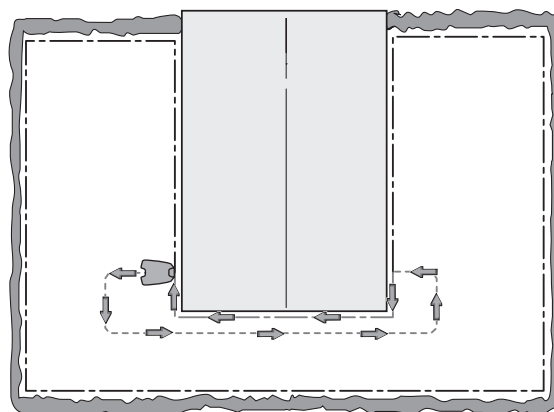

3023-009

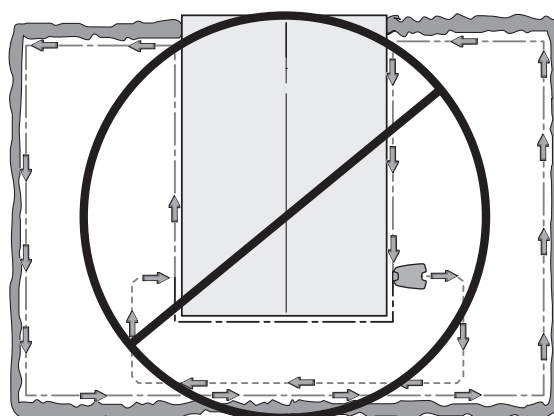

3023-010

2. Tilt the top cover on the charging station forward and run the guide wire up the channel leading to the guide connection.
3. Fit a connector to the guide wire in the same way as for the boundary wire in *3.5 Connecting the Boundary Wire*. Connect it to the contact pin on the charging station that is labeled G1. On an installation where several guides are to be connected, use G2 and G3 (Automower® 430X and Automower® 450X).
4. Mark the wires with wire labels. This makes it easier to reconnect the wires correctly when for instance the charging station has been stored indoors for the winter.
5. Run the guide wire straight under the charging plate and then at least 2 m / 7 ft straight out from the front edge of the plate.

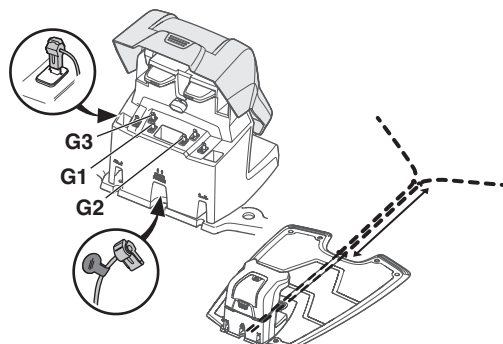

3012-1123

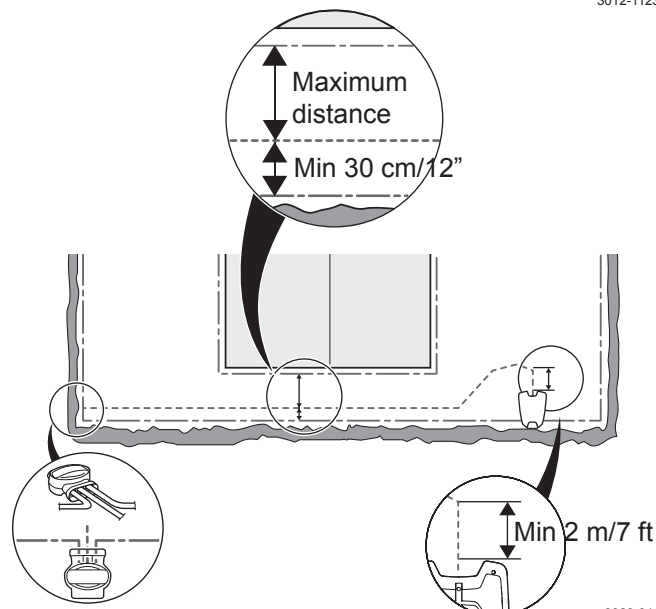

3023-011

English - 29

INSTALLATION

If the guide wire has to be installed on a steep slope, it is an advantage to lay the wire at an angle to the slope. This makes it easier for the robotic lawnmower to follow the guide wire on the slope.

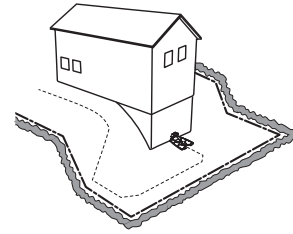

Avoid laying the wire at sharp angles. This can make it difficult for the robotic lawnmower to follow the guide wire.

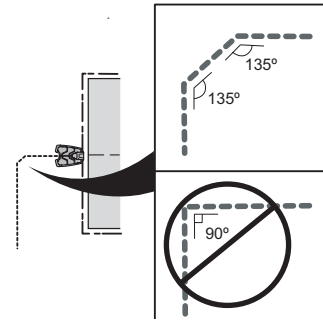

3012-560

6. Run the guide wire to the point on the boundary wire where the guide wire is to be connected.

Lift up the boundary wire. Cut the boundary wire using for instance a pair of wire cutters. Connecting the guide wire is easier if a loop is made on the boundary wire as described above, see *Loop for connecting the guide wire on page 25*.

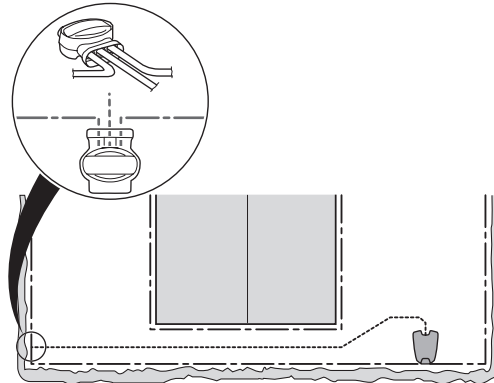

3023-015

7. Connect the guide wire to the boundary wire using a coupler:

Insert the boundary wire into each of the holes in the coupler. Insert the guide wire in the center hole in the coupler. Make sure the wires are fully inserted in the coupler by checking that the ends are visible through the transparent area on the opposite side of the coupler.

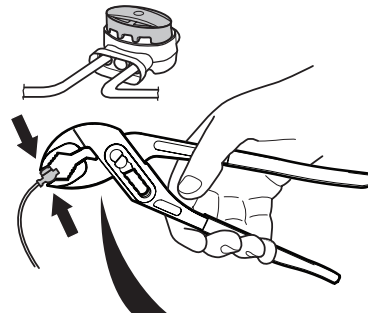

Use pliers to completely depress the button on the connector.

It does not matter which holes are used to connect each wire.



3018-055

8. Peg down/bury the connector in the lawn.

IMPORTANT INFORMATION

The guide wire may not cross the boundary wire, for instance a boundary wire that is laid out to an island.

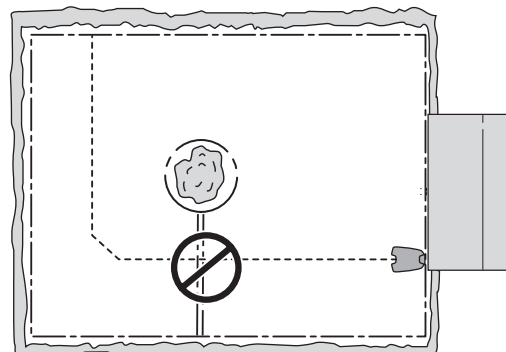

3023-016



INSTALLATION

3.7 Checking the Installation

Check the loop signal by inspecting the indicator lamp on the charging station.

- Solid green light = good signals.
- Flashing green light = loop system is shut down and the robotic lawnmower is in ECO mode, see 6.9 *Settings on page 61*.
- Flashing blue light = interruption in the boundary loop, no signal.
- Flashing red light = interruption in the charging station's antenna plate. The fault should be rectified by an authorized dealer.
- Solid blue light = weak signal. This may depend on the boundary loop being too long or that the wire is damaged. If the robotic lawnmower still works, this is not a problem.
- Solid red light = fault in the circuit board in the charging station. The fault should be rectified by an authorized dealer.

If anything other than a solid green light or flashing light is shown, see chapter 9.3 *Indicator Lamp in Charging Station page 84*.

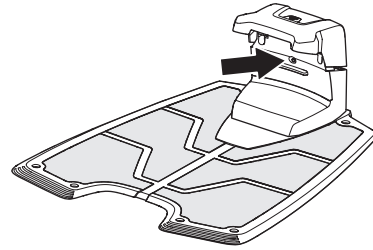

3012-1066

INSTALLATION

3.8 First Start-up and Calibration

Before the robotic lawnmower is operated, a start-up sequence in the robotic lawnmower's menu must be carried out as well as an automatic calibration of the guide signal.

1. Open the control panel cover by pressing the **STOP** button.
2. Set the main switch to position 1.

A start-up sequence begins when the robotic lawnmower is started for the first time. The following is requested:

- Language
- Country
- Date
- Time
- Four digit PIN code. All combinations except 0000 are permitted.

Dock the robotic lawnmower in the charging station and press **START**.

The robotic lawnmower will now begin to calibrate the cutting height adjustment. When this is complete the guide wires will be calibrated. Press **START** and close the cover. The calibration is performed by the robotic lawnmower backing out of the charging station and running a calibration process in front of the charging station. When this is completed, mowing can begin.

IMPORTANT INFORMATION

Use Memo on page 2 to make a note of the PIN code.

3.9 Test Docking with the Charging Station

Before using the robotic lawnmower, check that the robotic lawnmower can follow the guide wire all the way to the charging station and easily docks with the charging station.

The test function is in the robotic lawnmower *Installation* > *Find charging stations* > *Guide* > *More* > *Test Guide X* menu. For more information, see *More* > *Test on page 58*.

If more than one guide wire is installed, the test must be carried out on all guide wires.

If no guide wire is installed the test must be carried out on the boundary wire, both clockwise and anti-clockwise.

The guide system must first be calibrated if the above test is to provide a satisfactory result, see *3.8 First Start-up and Calibration on page 32*.

4 Usage

4.1 Charging a Discharged Battery

When the Husqvarna robotic lawnmower is new or has been stored for a long period, the battery will be flat and needs to be charged before starting.

1. Set the main switch in position 1.
2. Park the robotic lawnmower in the charging station. Open the cover and slide the robotic lawnmower in as far as possible to ensure proper contact between the robotic lawnmower and the charging station.
3. The display shows a message that charging is in progress.

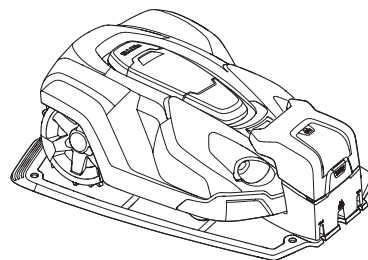

3012-1046

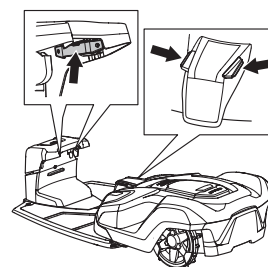

3012-1070



WARNING

Read the safety regulations before you start your robotic lawnmower.



1001-003



WARNING

Keep your hands and feet away from the rotating blades. Never put your hands or feet close to or under the body when the motor is running.



3012-663



WARNING

Never use the robotic lawnmower if any people, especially children, or pets, are in the immediate vicinity.

USAGE

4.2 Using the Timer

The lawn should not be cut too often to obtain the best mowing result. Use the timer function (see 6.3 *Timer on page 43.*) to avoid a downtrodden lawn and to get the maximum life from the robotic lawnmower. When setting the timer, count on the robotic lawnmower mowing about:

	Automower®		
	420	430X	450X
m ² / acre per hour and day	90 / 0.022	135 / 0.033	210 / 0.052

If your yard, for instance, comprises 1200 m² of grass, the mower should work on average

	Automower®		
	420	430X	450X
Hours per day	13	9	6

The times are approximate and depend for instance on grass quality, blade sharpness and battery age.

IMPORTANT INFORMATION

Use the timer to avoid mowing when there are usually children, pets and anything else about that could be hurt or damaged by the rotating blades on the lawn.

The factory setting is that the robotic lawnmower will operate around the clock seven days a week.

If the size of the working area allows it, the quality of the grass can be further improved if it is cut every other day instead of a few hours every day. In addition, the grass benefits from resting completely during at least a three-day period once a month.

The maximum capacity is obtained when the robotic lawnmower is allowed to mow around the clock seven days a week.

	Automower®		
	420	430X	450X
Maximum capacity, m ² / acre	2 200 / 0.55	3 200 / 0.8	5 000 / 1.25

USAGE

4.3 Start

1. Open the control panel cover by pressing the **STOP** button.
2. Set the main switch in position *1*.
3. Enter the PIN code.
4. Push the Start button.
5. Select the desired operating mode, see 5.1 *Operating Mode Start on page 38*.
6. Shut the hatch within 10 seconds.

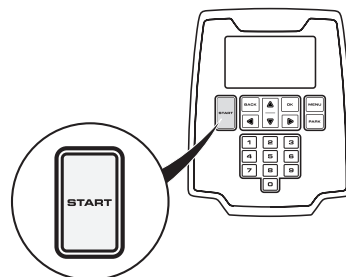

3012-1204

If the robotic lawnmower is parked in the charging station, it will only leave the charging station when the battery is fully charged and if the timer is set to allow the mower to operate.

Before the blade disc starts a warning beep can be heard consisting of 5 short beeps for 2 seconds.

4.4 Stop

1. Press the **STOP** button.

The robotic lawnmower stops, the blade motor stops and the control panel hatch opens.

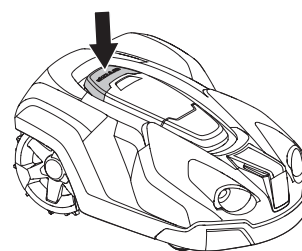

3012-1044

4.5 Switching Off

1. Press the **STOP** button.
2. Set the main switch in *0* position.

Always switch the robotic lawnmower off using the main switch if it requires maintenance or if the robotic lawnmower must be moved outside the working area.

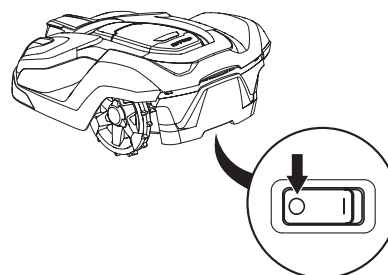

3012-1060

USAGE

4.6 Adjusting Cutting Height

The cutting height can be varied from MIN (2 cm / 0.8 ") to MAX (6 cm / 2.5 ") in nine stages.

During the first week after a new installation, the cutting height must be set to MAX to avoid damaging the loop wire. After this, the cutting height can be lowered one step every week until the desired cutting height has been reached.

If the grass is long, allow the robotic lawnmower to start mowing at the MAX cutting height. Once the grass is shorter, you can gradually lower the cutting height.

To adjust the cutting height:

1. Press the **STOP** button to stop the robotic lawnmower and open the hatch.
2. Press the **MENU** button to access the main menu.
3. Move the cursor using the arrow keys to select *Cutting height*.
 - Press the up arrow key to increase the cutting height.
 - Press the down arrow key to lower the cutting height.
4. Press **OK**.

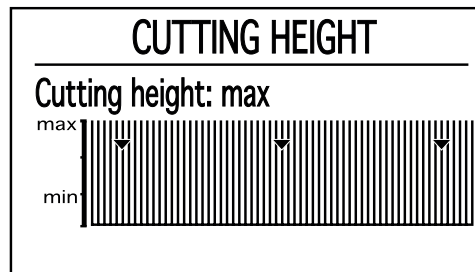

3012-1237

IMPORTANT INFORMATION

During the first week after a new installation, the cutting height must be set to MAX to avoid damaging the loop wire. After this, the cutting height can be lowered one step every week until the desired cutting height has been reached.

CONTROL PANEL

5 Control Panel

All forms of commands and settings for the robotic lawnmower are made via the control panel. All functions are accessed via a number of menus.

The control panel consists of a display and a keypad. All information is shown on the display and all input is done using the buttons.

When the STOP button has been pressed and the hatch is opened, the start page is displayed showing the following information:

- Operating information, e.g. *MOWING*, *PARKED* or *TIMER*. If the stop button is pressed while the robotic lawnmower is running, what it did just before it was stopped e.g. *MOWING* or *SEARCHING* is displayed. The text *READY* is displayed if the robotic lawnmower is not in any specific operating mode, e.g. if the main switch has just been turned on.
- Date and clock show the current time.
- **Automower® 430X and Automower® 450X.** The satellite system is shown when GPS assisted navigation is enabled. Symbol (A) is displayed when the robotic lawnmower has established contact with a sufficient number of GPS satellites. Symbol (B) is displayed if the robotic lawnmower does not have contact with a sufficient number of satellites. Symbol (A) flashes during the first days the robotic lawnmower is working as it gathers GPS information concerning the installation.
- The ECO symbol is displayed if the robotic lawnmower is set to ECO mode.
- The black clock symbol (C) is displayed when the robotic lawnmower is not allowed to mow due to a timer setting. If the robotic lawnmower is not allowed to mow due to the *Weather Timer*, symbol (D) is displayed. If the *Override Timer* operating mode is selected, symbol (E) will be displayed.
- The battery status shows the remaining battery charge. If the robotic lawnmower is being charged, a flash symbol will be displayed above the battery symbol (F). If the robotic lawnmower is standing in the charging station but not charging, (G) will be displayed.
- The height adjustment setting is displayed as a scale/numerical value.
- The number of operating hours shown is the number of hours since its day of manufacture that the robotic lawnmower has been in operation. The time that the robotic lawnmower has spent mowing or looking for the charging station is counted as operating time.
- If using the Profiles function, the name of the active profile will be displayed. An asterisk next to the name indicates that the profile has changes that have not been saved.



3012-1094



3012-1260



3012-570



3012-1379

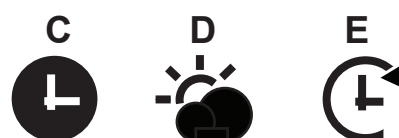

3012-1266

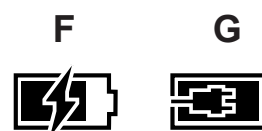

3012-569

CONTROL PANEL

- When Automower® Connect is activated (standard on Automower 450X, accessories for 420 and 430X), icons for this are displayed on the mower's start page. The bars (H) show the signal strength of the GPRS reception. An X next to the bars (J) indicates a problem has arisen concerning the connection with the Internet server. The SIM symbol (K) indicates there is a problem with the SIM card or the module.



3012-1439

The keypad comprises six groups of buttons:

- The START** button is used to activate the robotic lawnmower. This is normally the last button to be pressed before closing the display hatch.
- The Back** and **OK** buttons are used to navigate in the menu. **The OK** button is also used to confirm settings in the menu.
- The arrow keys are used to navigate in the menu but also to make selections in certain setting options.
- The MENU** button is used to go to the main menu.
- The PARK** button is used to send the robotic lawnmower to the charging station.
- Numbers are used to enter settings, for example, PIN code, time or exit direction. They can also be used to enter a number series for shortcuts to the various menus, see 6.1 Main Menu on page 41.



3012-1094

5.1 Operating Mode Start

When the **START** button has been pressed, the following operating modes can be selected.

Main area

The standard, automatic operating mode where the robotic lawnmower mows and charges continually.

Secondary area

The *Secondary Area* operating mode is used when mowing secondary areas where the robotic lawnmower cannot travel to the charging station automatically. Refer to page 20 for more information on secondary areas

Selecting Secondary Area offers three options:

- Mowing until empty battery**
This option is suitable for a large secondary area requiring more than 90 minutes to mow.
- Mow 90 minutes**
This option is suitable to prevent unnecessary mowing and trampled grass in a small/medium sized secondary area.
- Mow 30 minutes**
This option is suitable to prevent unnecessary mowing and trampled grass in a small sized secondary area.



3012-1263



CONTROL PANEL

If the robotic lawnmower charges in *Secondary Area* mode, it will fully charge, drive out about 50 cm / 20 " and then stop. This indicates that it is charged and ready to start mowing.

If the main working area has to be cut after charging, it is appropriate to switch the operating mode to *Main Area* before placing the robotic lawnmower in the charging station.

Override timer

Any timer settings made can be temporarily overridden by selecting *Override Timer*. It is possible to override the timer for 24 hours or 3 days.

Spot cutting

Spot cutting means that the robotic lawnmower operates in a spiral pattern to mow the lawn in the area it was started. When it is finished, the robotic lawnmower will automatically go to *Main Area* or *Secondary Area* operating mode.

This is a useful function to quickly cut down the lawn in an area that has been cut less often than other areas in the yard.

The *Spot Cutting* function is activated with the START button. It is possible to select how the robotic lawnmower is to operate after mowing by pressing *Right arrow* and then selecting *Main Area* or *Secondary Area*.

5.2 Operation Mode Parking

When the **PARK** button is pressed, the following operating modes can be chosen.

Parked until further notice

The robotic lawnmower stays in the charging station until another operating mode is selected by pressing the **START** button.

Start again in 3 hours

The robotic lawnmower stays in the charging station for three hours and then returns automatically to normal operation. This operation selection is suitable when there is a need to pause operation, e.g. for temporary irrigation or for games on the lawn.

Start with next timer

The robotic lawnmower stays in the charging station until the next Timer setting permits operation. This operation selection is suitable if one wishes to cancel an ongoing mowing cycle and allow the robotic lawnmower to stay in the charging station until the next day.

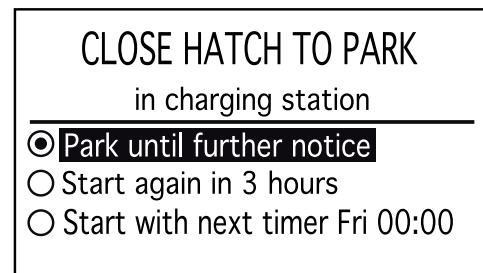

3012-1223





CONTROL PANEL

5.3 Main Switch

Put the main switch to position *1* to start the robotic lawnmower.

Set the main switch in the *0* position when the robotic lawnmower is not in use or work is being carried out on the blade disc.

When the main switch is set in the *0* position, the motors on the robotic lawnmower cannot start.

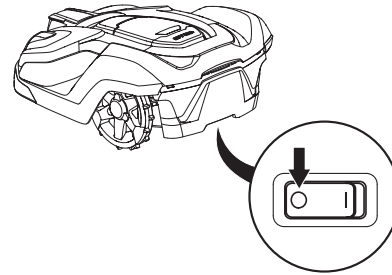

3012-1060

5.4 The Charging Station's PARK Button

Automower® 430X and Automower® 450X.

The PARK button on the charging station is used to call the robotic lawnmower back to the charging station. The PARK button on the keypad in the robotic lawnmower offers the same function. The PARK button on the charging station is useful for instance when the robotic lawnmower operates in a large working area and the charging station is more accessible.

An LED in the PARK button is lit solid when the button has been pressed. The LED diode goes out when the robotic lawnmower is parked in the charging station.

The robotic lawnmower remains parked in the charging station until the **START** button on the robotic lawnmower keypad is pressed.

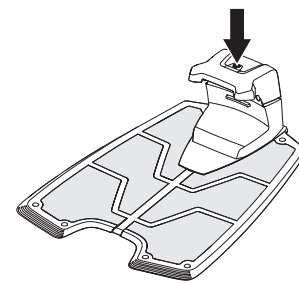

3012-1215



MENU FUNCTIONS

6 Menu Functions

6.1 Main Menu

The main menu consists of the following options:

- *Timer*
- *Cutting height*
- *Security*
- *Messages*
- *Weather timer*
- *Installation*
- *Settings*
- *Accessories*

There are a number of submenus under each option. You can access all the functions to set the robotic lawnmower settings via these.

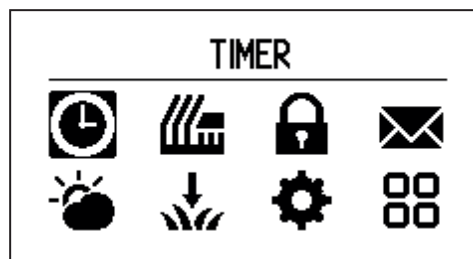

3012-1440

Browsing between menus

Browse through the main menu and submenus with the help of the arrow keys. Enter values and times using the number keys and confirm each selection with **OK**. Press **BACK** to move one step back or press **MENU** to go directly to the main menu.



3012-1094

Submenus

Certain submenus contain a box that can be checked. This is used to select which option(s) is/are selected or if a function is activated/deactivated. Select or deselect the box by pressing **OK**.

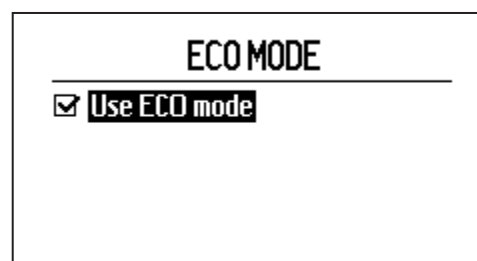









3012-1407

MENU FUNCTIONS

6.2 Menu Structure

The following table summarizes the menu selections found in the main menu. The following chapter provides more detailed information about how each function is used and which setting options are available.

Use the arrow keys to browse the menu. Confirm selections with OK.

	<p><i>Timer</i></p> <p>The lawn should not be cut too often to obtain the best mowing result. Consequently, it is important to limit the operating time using the timer function if the working area is less than the robotic lawnmower's working capacity. The timer function is also an ideal means to control which work hours the robotic lawnmower should not mow, for example, when the children are playing in the yard.</p>
	<p><i>Cutting height</i></p> <p>The cutting height can be varied from MIN (2 cm / 0.8 ") to MAX (6 cm / 2.5 "). During the first week after a new installation, the cutting height must be set to MAX to avoid damaging the loop wire. After this, the cutting height can be lowered one step every week until the desired cutting height has been reached.</p>
	<p><i>Security</i></p> <p>In this menu, settings relating to security and the connection between the robotic lawnmower and the charging station can be made. There are three security levels to choose from but it is also possible to define your own combination of security functions.</p>
	<p><i>Messages</i></p> <p>Historical faults and information messages can be read in this menu. Regards some of the most common fault messages, there are tips and advice to help you rectify the fault, see 9.1 <i>Fault Messages on page 80</i>.</p>
	<p><i>Weather timer</i></p> <p>This function allows the robotic lawnmower to automatically adjust its mowing times based on how quick the lawn grows. When the weather is good for grass growth, the robotic lawnmower mows more often and when grass growth is slower, the robotic lawnmower will automatically spend less time on the lawn.</p>
	<p><i>Installation</i></p> <p>This menu is used to steer the robotic lawnmower to remote parts of the working area and to control how the robotic lawnmower searches for the charging station. The factory settings can be kept for many working areas, i.e. allow the robotic lawnmower itself to combine the various search methods and the underlying settings.</p>
	<p><i>Settings</i></p> <p>This selection allows you to make changes to the general robotic lawnmower settings such as date and time.</p>
	<p><i>Accessories</i></p> <p><i>Settings for accessories mounted on the mower can be made in this menu. Get in touch with your local dealer for more information concerning the accessories that are available for your robotic lawnmower.</i></p>

MENU FUNCTIONS

6.3 Timer



The lawn should not be cut too often to obtain the best mowing result. Consequently, it is important to limit the operating time using the timer function if the working area is less than the mower's working capacity. When the robotic lawnmower is allowed to mow too much, the lawn may appear flattened. Besides, the robotic lawnmower is subjected to unnecessary wear.

The timer function is also an ideal means to control which work hours the robotic lawnmower should not mow, for example, when the children are playing in the yard.

Maximum performance is obtained when the timer is turned off and the robotic lawnmower is allowed to mow around the clock seven days a week. Hours of operation and days are shown graphically on the robotic lawnmower display. Active mowing per day are illustrated with a black bar. The rest of the time, the robotic lawnmower is standing in the charging station.

The factory setting is that the timer is inactive and the robotic lawnmower will operate around the clock seven days a week. A suitable setting for a working area is normally one corresponding to the robotic lawnmower's maximum performance, i.e.

	Automower®		
	420	430X	450X
Maximum capacity, m ² / acre	2 200 / 0.55	3 200 / 0.8	5 000 / 1.25

When setting the timer, count on the robotic lawnmower mowing the number of square meters per hour and day specified in the table *Working Capacity see 4.2 Using the Timer on page 34*.

The tables below give suggestions of different timer setting depending on the size of the yard. The tables can be used when setting the operating time. Times should be regarded as general. They may have to be adapted to suit the yard. Use the tables is in the following way:

1. Select the working area that is most like the yard.
2. Select a suitable number of working days per week (7 days may be necessary for some working areas).
3. Working hours per day shows how many hours per day that the robotic lawnmower can operated during the selected number of working days.
4. The suggested interval is the interval corresponding to the desired number of working hours per day.

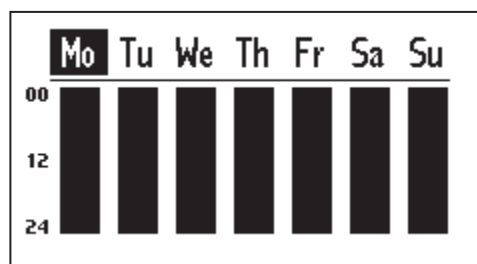
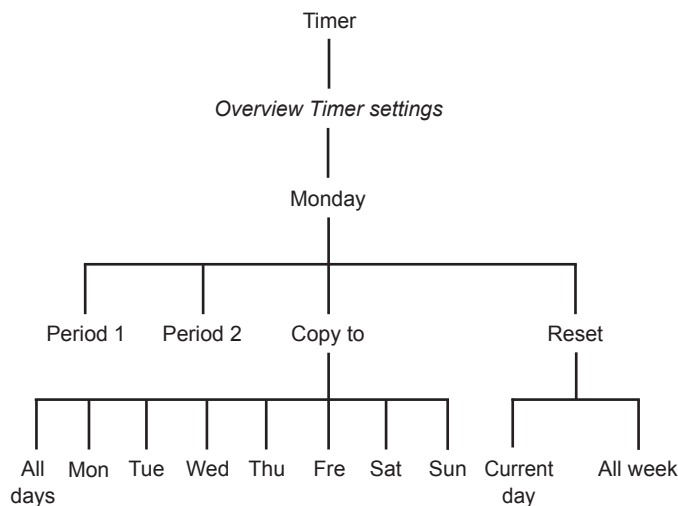

3012-1431

MENU FUNCTIONS

Automower® 420			
Working area capacity	Working days per week	Working hours per day	Suggested interval
500 m ² / 0.12 acre	5	7.5 hours	7:00 AM - 2:30 PM
	7	5.5 hours	7:00 AM - 12:30 PM
750 m ² / 0.19 acre	5	11.5 hours	7:00 AM - 6:30 PM
	7	8 hours	7:00 AM - 3:00 PM
1 000 m ² / 0.25 acre	5	15.5 hours	7:00 AM - 10:30 PM
	7	11 hours	7:00 AM - 6:00 PM
1 250 m ² / 0.31 acre	5	19 hours	4:00 AM - 11:00 PM
	7	13.5 hours	7:00 AM - 8:30 PM
1 500 m ² / 0.4 acre	5	23 hours	12:00 AM - 11:00 PM
	7	16.5 hours	7:00 AM - 11:30 PM
1 750 m ² / 0.45 acre	6	22.5 hours	12:00 AM - 10:30 PM
	7	19 hours	4:00 AM - 11:00 PM
2 000 m ² / 0.50 acre	7	22 hours	12:00 AM - 10:00 PM
2 200 m ² / 0.54 acre	7	24 hours	12:00 AM - 12:00 AM

Automower® 430X			
Working area capacity	Working days per week	Working hours per day	Suggested interval
500 m ² / 0.12 acre	5	5.5 hours	7:00 AM - 12:30 PM
	7	4 hours	7:00 AM - 11:00 AM
750 m ² / 0.19 acre	5	8 hours	7:00 AM - 3:00 PM
	7	5.5 hours	7:00 AM - 12:30 PM
1 000 m ² / 0.25 acre	5	10.5 hours	7:00 AM - 5:30 PM
	7	7.5 hours	7:00 AM - 2:30 PM
1 250 m ² / 0.31 acre	5	13 hours	7:00 AM - 08:00 PM
	7	9.5 hours	7:00 AM - 4:30 PM
1 500 m ² / 0.4 acre	5	16 hours	7:00 AM - 11:00 PM
	7	11.5 hours	7:00 AM - 6:30 PM
1 750 m ² / 0.45 acre	5	18.5 hours	5:00 AM - 11:30 PM
	7	13 hours	7:00 - 8:00 PM
2 000 m ² / 0.50 acre	5	21 hours	2:00 AM - 11:00 PM
	7	15 hours	7:00 - 10:00 PM
2 250 m ² / 0.56 acre	5	23.5 hours	12:00 AM - 11:30 PM
	7	17 hours	7:00 AM - 12:00 AM
2 500 m ² / 0.62 acre	6	22 hours	1:00 AM - 11:00 PM
	7	19 hours	4:00 AM - 11:00 PM
2 750 m ² / 0.68 acre	6	24 hours	12:00 AM - 12:00 AM
	7	20.5 hours	3:00 AM - 11:30 PM
3 000 m ² / 0.74 acre	7	22.5 hours	1:00 AM - 11:30 PM
3 200 m ² / 0.79 acre	7	24 hours	12:00 AM - 12:00 AM

Automower® 450X			
Working area capacity	Working days per week	Working hours per day	Suggested interval
500 m ² / 0.12 acre	5	3.5 hours	7:00 AM - 10:30 AM
	7	2.5 hours	7:00 AM - 9:30 AM
750 m ² / 0.19 acre	5	5.5 hours	7:00 AM - 12:30 PM
	7	4 hours	7:00 AM - 11:00 AM
1 000 m ² / 0.25 acre	5	7 hours	7:00 AM - 2:00 PM
	7	5 hours	7:00 AM - 12:00 PM
1 250 m ² / 0.31 acre	5	8.5 hours	7:00 AM - 3:30 PM
	7	6 hours	7:00 AM - 1:00 PM

MENU FUNCTIONS

1 500 m ² / 0.4 acre	5	10.5 hours	7:00 AM - 5:30 PM
	7	7.5 hours	7:00 AM - 2:30 PM
1 750 m ² / 0.45 acre	5	12 hours	7:00 AM - 7:00 PM
	7	8.5 hours	7:00 AM - 3:30 PM
2 000 m ² / 0.50 acre	5	13.5 hours	7:00 AM - 8:30 PM
	7	10 hours	7:00 AM - 5:00 PM
2 250 m ² / 0.56 acre	5	15.5 hours	7:00 AM - 10:30 PM
	7	11 hours	7:00 AM - 6:00 PM
2 500 m ² / 0.62 acre	5	17 hours	5:00 AM - 10:00 PM
	7	12 hours	7:00 AM - 7:00 PM
2 750 m ² / 0.68 acre	5	18.5 hours	5:00 AM - 11:30 PM
	7	13.5 hours	7:00 AM - 8:30 PM
3 000 m ² / 0.74 acre	5	20.5 hours	3:00 AM - 11:30 PM
	7	14.5 hours	7:00 AM - 9:30 PM
3 250 m ² / 0.80 acre	5	22 hours	1:00 AM - 11:00 PM
	7	16 hours	7:00 AM - 11:00 PM
3 500 m ² / 0.86 acre	5	24 hours	12:00 AM - 12:00 AM
	7	17 hours	6:00 AM - 11:00 PM
3 750 m ² / 0.93 acre	6	21 hours	2:00 AM - 11:00 PM
	7	18 hours	5:00 AM - 11:00 PM
4 000 m ² / 1.0 acre	6	22.5 hours	12:00 AM - 10:30 PM
	7	19.5 hours	4:00 AM - 11:30 PM
4 250 m ² / 1.05 acre	6	24 hours	12:00 AM - 12:00 AM
	7	20.5 hours	3:00 AM - 11:30 PM
4 750 m ² / 1.17 acre	7	23 hours	12:00 AM - 11:00 PM
5 000 m ² / 1.25 acre	7	24 hours	12:00 AM - 12:00 AM

Change day

To change the timer settings, first select the day to change from the *Overview* screen with the left and right arrows, followed by OK.

Up to two intervals per day can be specified. To specify an interval for Period 1, first make sure the box next to Period 1 is checked. Check/uncheck by selecting it and pressing OK. Specify the desired times using the numerical keypad.

If two intervals are wanted, first check the box next to Period 2 and then specify the times as above. Two intervals can be useful if the lawn is used for other activities during certain times, specifying Period 1 for example: 00:00–15:00 and period 2: 21:00–24:00. The mower will then be parked in the charging station between 15.00 and 21.00.

To deactivate mowing for an entire day, both periods must be unchecked.

Copy to

Use this function to copy the current day settings to other days.

Use the up and down arrow keys to move the cursor between days. The times will be copied to the days that are marked with **OK**.

MONDAY

Period 1: 10:00 – 15:00

Period 2: ---:---:---:---

Copy
Reset

3012-1432

COPY MONDAY TO

All days Thursday

Monday Friday

Tuesday Saturday

Wednesday Sunday

3012-1406

English - 45



MENU FUNCTIONS

Reset

This function resets the timer to the factory setting, where the robotic lawnmower is allowed to operate 24 hours a day every day.

Current day

This resets the day that is selected in the tab system.

The factory setting is that the robotic lawnmower is allowed to operate 24 hours a day.

All week

This resets all days in the week.

The factory setting is that the robotic lawnmower is allowed to operate 24 hours a day every day.

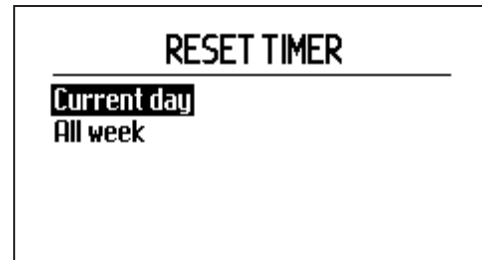

3012-1408

6.4 Cutting Height

The cutting height can be varied from MIN (2 cm / 0.8 ") to MAX (6 cm / 2.5 ").

During the first week after a new installation, the cutting height must be set to MAX to avoid damaging the loop wire. After this, the cutting height can be reduced one step every week until the desired cutting height has been reached.

If the grass is long, allow the robotic lawnmower to start mowing at the MAX cutting height. The cutting height can be reduced gradually once the grass has become shorter.

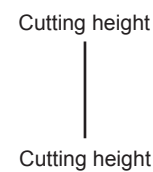

To increase the cutting height:

1. Use the up arrow to increase to the desired height, or specify a number directly with the keypad.
2. Press **OK** to confirm.

To lower the cutting height:

1. Use the down arrow to decrease to the desired height, or specify a number directly with the keypad.
2. Press **OK** to confirm.

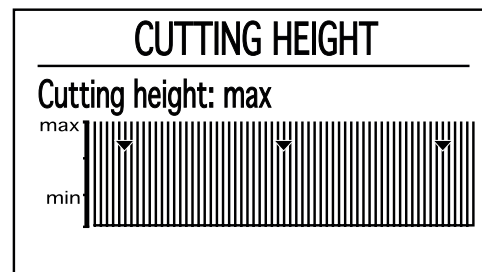

3012-1237



MENU FUNCTIONS

6.5 Security

Through this selection, settings relating to security and the connection between the mower and the charging station can be made.



Security level

There are three security levels to choose from but it is also possible to define your own combination of security functions.

The factory setting is security level Medium.

Use the down and up arrow keys to select a security level.

Low and medium security prohibits access to the robotic lawnmower if the PIN code is unknown. High security also includes a warning that beeps if the correct PIN code is not entered after a designated time period.

To activate the robotic lawnmower, depress the stop button and turn the main switch to 0.

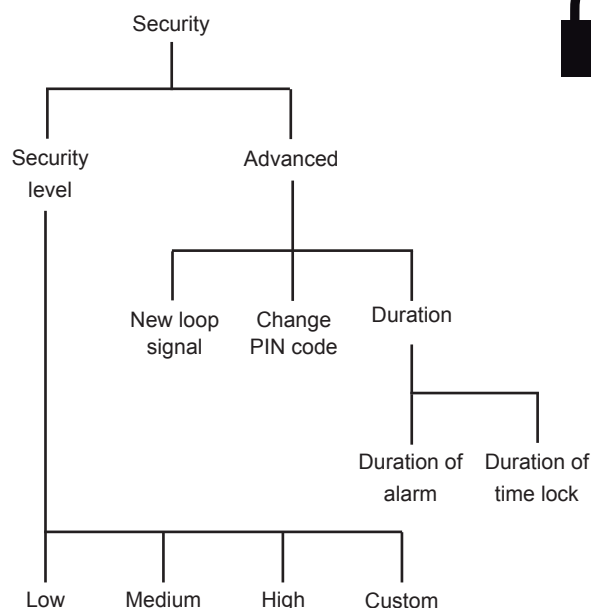

Function	Low	Medium	High
Time lock	X	X	X
PIN request		X	X
Alarm			X

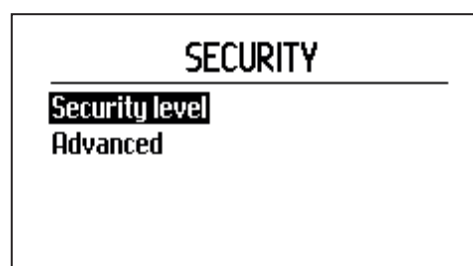

3012-1409

Time lock

This function means that the robotic lawnmower cannot be started after 30 days without first entering the correct PIN code. When 30 days have passed, the robotic lawnmower will continue to mow as normal, but the *Enter PIN code* message will be displayed when the hatch is opened. Then enter your code and press **OK**.

The PIN code must be entered every time the main switch is set to 1.

PIN request

This function means that the robotic lawnmower requests a PIN code each time the hatch is opened. The correct PIN code must be entered to use the robotic lawnmower.

If the wrong PIN code is entered 5 times in succession the robotic lawnmower is blocked for a time. The blockage time is extended for every new incorrect attempt.

Alarm

This function means that an alarm sounds if the PIN code is not entered within 10 seconds after the **STOP** button has been pressed or the robotic lawnmower has been lifted up for any reason. A ticking noise indicates that the PIN code must be entered to prevent triggering the alarm. The alarm can be turned off at any time by entering the correct PIN code.



MENU FUNCTIONS

Custom

This menu allows you to customize and combine the available security functions to suit your needs.

Time lock

Activate or deactivate the PIN request after a certain number of days. The number of days can be set in *Security - Advanced*.

NB! Time lock is the most important theft-prevention function and it is recommended to have it activated at all times.

PIN if stopped

Activate or deactivate PIN request when the STOP button has been pressed.

Alarm & PIN if stopped

Activate or deactivate alarm when the STOP button has been pressed.

Alarm & PIN if lifted

Activate or deactivate alarm when the robotic lawnmower is lifted e.g. if it is carried somewhere.

This function may need to be deactivated in working areas where the robotic lawnmower has to be repeatedly lifted due to collisions with for instance gently sloping stones or tree roots.

Alarm & code if tilted

Activate or deactivate alarm when the robotic lawnmower is tilted e.g. if it is carried somewhere.

Advanced

New loop signal

The loop signal is randomly selected to create a unique link between the robotic lawnmower and the charging station. In rare cases, there may be a need to generate a new signal, for instance if two adjacent installations have a very similar signal.

1. Place the robotic lawnmower in the charging station to which the robotic lawnmower is to be connected.
2. Select *New loop signal* in the menu and press **OK**.
3. Press **OK** and await confirmation that the loop signal has been generated. This normally takes about 10 seconds.

Change PIN code

Enter the new PIN code and press OK. Confirm by entering the same code again and pressing OK. When the PIN code has been changed, the message *PIN code accepted* is displayed for a few seconds.

Make a note of the new PIN code on the designated line in *Memo* on page 2.

English - 48

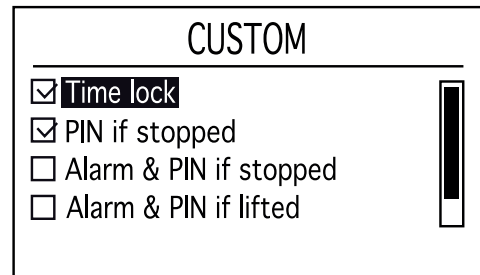

3012-1239





MENU FUNCTIONS

Duration of time lock

When *Time lock* is activated, there is also the possibility to select how many days the robotic lawnmower is to request a PIN code. A figure between 1 and 90 can be selected.

The factory setting is 30 days.

Duration of alarm

When *Alarm* is activated there is also the possibility to select how long the alarm signal should sound. A figure between 1 and 20 minutes can be selected.

6.6 Messages

Historical and information messages can be read using this function. Regards some of the most common fault messages, there are tips and advice to help you rectify the fault, see 9.1 *Fault Messages on page 80*.



Fault messages

If the robotic lawnmower is disrupted in any way e.g. gets stuck under a fallen branch a message is shown in the lawnmower's display relating to the disruption and the time it happened.

If the same fault message is repeated several times, this may indicate that an adjustment to the installation or the robotic lawnmower is required. For more information concerning the possible caused of each message, see 9.1 *Fault Messages on page 80*.

This list contains the latest 50 fault messages sorted by date with the last incident to occur first on the list.

The date and time when the fault messages are displayed can be shown by selecting a fault message and pressing the **OK** button.

Tips and advice on what to do to rectify the fault will also be displayed.

Info messages

Messages shown in the display not caused by an actual fault are instead saved under the *Info messages* heading. Examples for such messages are *Weak GPS signal* and *Slope too steep*. For more information concerning the possible caused of each message, see 9.1 *Fault Messages on page 80*.

This list contains the latest 50 fault messages sorted by date with the last incident to occur first on the list.

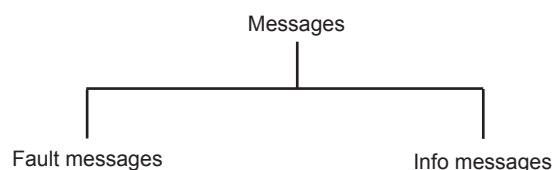



MENU FUNCTIONS

6.7 Weather Timer



This function allows the robotic lawnmower to automatically adjust its mowing times based on how quick the lawn grows. When the weather is good for grass growth, the robotic lawnmower mows more often and when grass growth is slower, the robotic lawnmower will automatically spend less time on the lawn.

The robotic lawnmower will however not operate longer than the time that may be configured in the timer settings. For optimal weather timer performance, it is recommended when setting the timer to only de-select the times when the robotic lawnmower must not operate. Other times should be made available for the weather timer.

When the weather timer is activated, the robotic lawnmower needs time to decide what the optimal mowing time is for the working area in question. For this reason it can take a number of days before the mowing results are optimal.

When the weather timer is activated, it is very important to regularly check that the blade disc is clean and that the blades are in good condition. Any grass twisted around the blade disc shaft or blunt blades can affect how the weather timer functions.

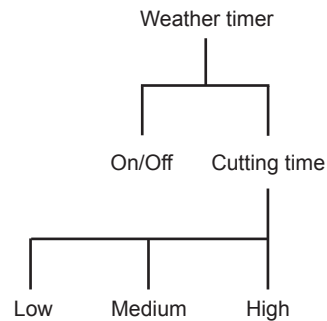

Weather timer

Check the box and press **OK** to activate the Weather Timer.

Cutting time

If the mowing results are not optimal when using the Weather timer, Cutting time settings may need adjusting.

To adjust the cutting time, place the cursor by Cutting Time and use the right and left arrow keys to increase or decrease the cutting time in three preset intervals.

The longer the chosen cutting time, the longer the robotic lawnmower is allowed to work.

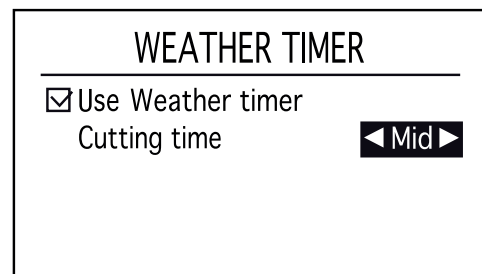

3012-1259





MENU FUNCTIONS

6.8 Installation

This menu function is used to steer the robotic lawnmower to remote parts of a working area and control how the robotic lawnmower searches for the charging station. For many working areas there is no need to alter the factory settings i.e. allow the robotic lawnmower itself to combine the various search methods and the underlying settings.

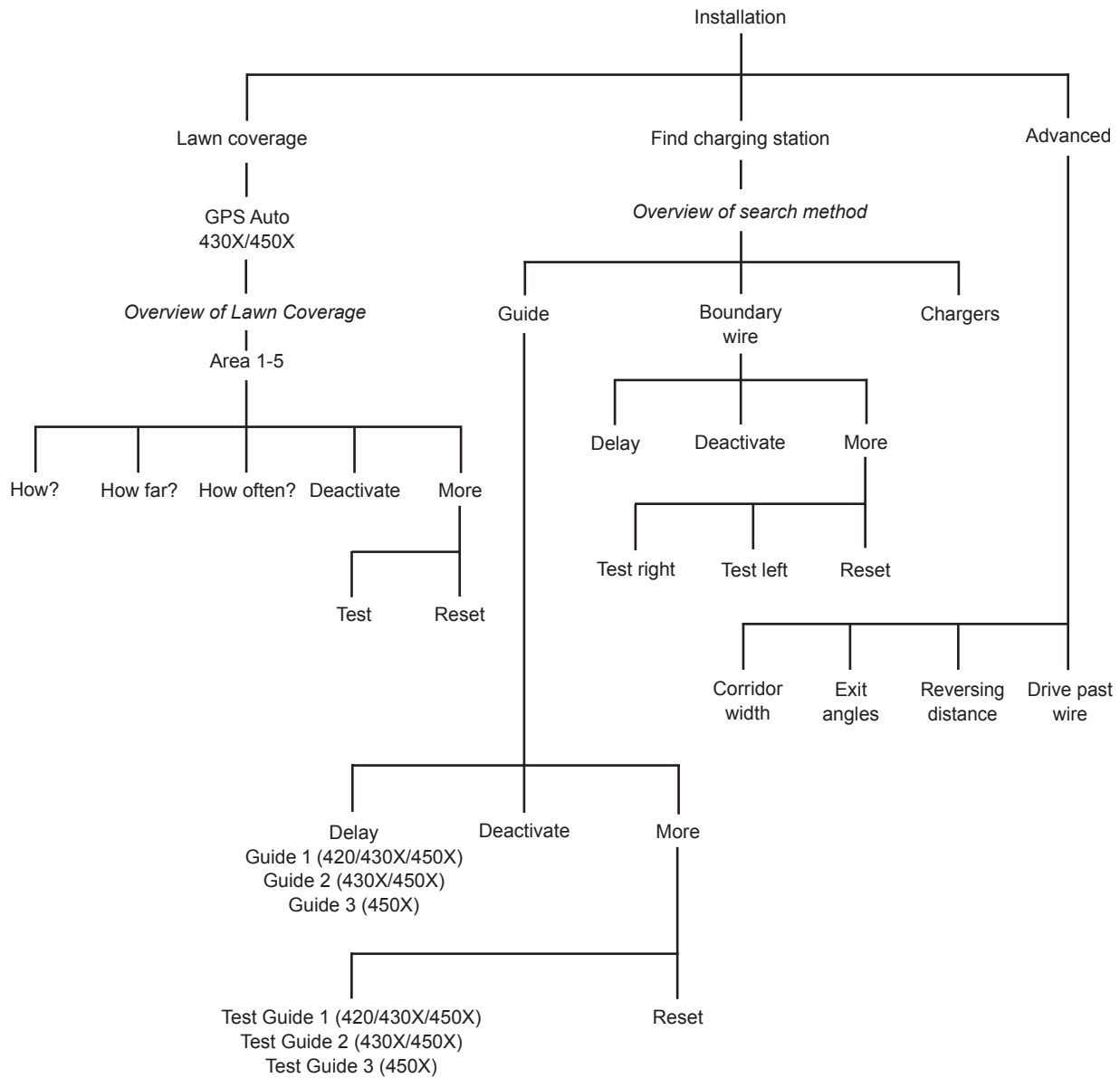



MENU FUNCTIONS

Lawn coverage

This menu function is used to steer the robotic lawnmower to remote parts of a working area. This important function is used to maintain an even mowing result in the entire working area. In very complex yards with for instance many areas which are joined by narrow passages, the mowing result can be improved by making a number of manual settings as described below.

It is also possible to test exit settings and to identify the distance from the charging station to a remote area.

The factory settings in Automower® 430X and Automower® 450X use a built-in GPS to check which areas are mowed and thereby which areas need to be mowed next. Automower® 430X and Automower® 450X can in this way automatically get to parts of the working area that are hard to reach.

IMPORTANT INFORMATION

No manual settings need to be made if GPS assisted navigation is used.

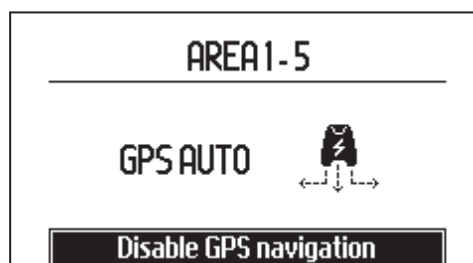

3012-1445

The factory settings in Automower® 420 allow the robotic lawnmower to follow the guide wire 300 m / 980 ft in 20 % of the times it leaves the charging station.

GPS assisted navigation

For Automower® 430X and Automower® 450X only.

GPS assisted navigation uses an inbuilt GPS to check which areas are mowed and thereby which areas need to be mowed next. After a number of days operating, the robotic lawnmower creates a map of the working area and where the guide wires are laid. In this way the Automower® 430X and Automower® 450X can automatically set distance and proportion for hard to reach parts of the working area.

The automatic settings made by the robotic lawnmower cannot be read in the display.

IMPORTANT INFORMATION

If the same robotic lawnmower is used for two or more charging stations that are close together (neighbors for instance), the GPS assisted navigation can only be used in one of the working areas. Otherwise the digital map can be misleading and the robotic lawnmower's lawn coverage can therefore be reduced.





MENU FUNCTIONS

If a problem should arise with GPS assisted navigation, the robotic lawnmower GPS map can be reset. Normally, this is not necessary.

Reset GPS map: *Settings > General > Reset > Reset GPS map* For more information, see *More > Test on page 58*.

Select Reset GPS map and press OK.

Manual settings

Area 1-5

Up to five (three for Automower® 420) remote areas can be set. A number of unique selections are required to allow the robotic lawnmower to reach the remote area.

IMPORTANT INFORMATION

When the GPS assisted navigation is activated, this will be used so long there is a GPS service - even if manual settings are carried out. Only when a GPS service is not available will the manual settings be used.

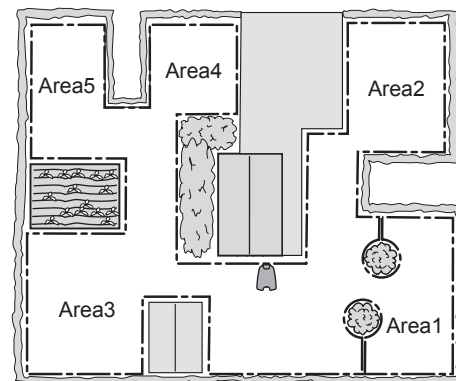

3023-045

Deactivate GPS assisted navigation (Automower® 430X and Automower® 450X). Only then can any manual settings be made.

Use the right and left arrow keys to mark the area for manual settings and press **OK**.

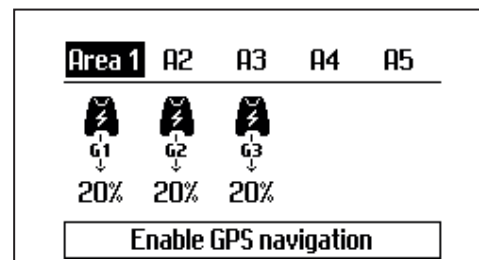

3012-1437

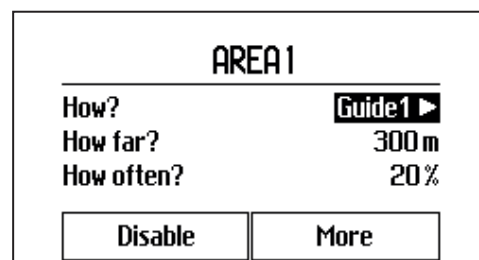

3012-1438

Area X > How?

Specify Right, Left, Guide 1, Guide 2 or Guide 3 depending on which direction the area lies from the charging station. The direction (right or left) is counted as that seen facing the charging station.

Use the right and left arrow keys to alternate between the different options.

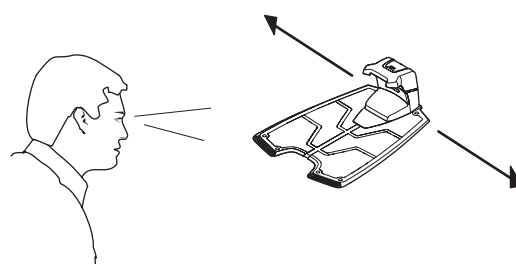

3012-1100

English - 53





MENU FUNCTIONS

Area X > How far?

Enter the distance in meters along the relevant wire from the charging station to the location in the remote area where the robotic lawnmower is to begin mowing.

Use the number keys to specify the distance in meters.

Tip! Use the *Test* function to determine how far it is to the remote area. The distance, in meters, will be shown in the lawnmower display when **STOP** is pressed. Refer to page 55. The measured distance shown in the display can be saved directly in chosen remote area. The existing values will then be replaced with the new distances.

The factory setting for Automower® 420 is 300 m / 980 ft for Guide 1.

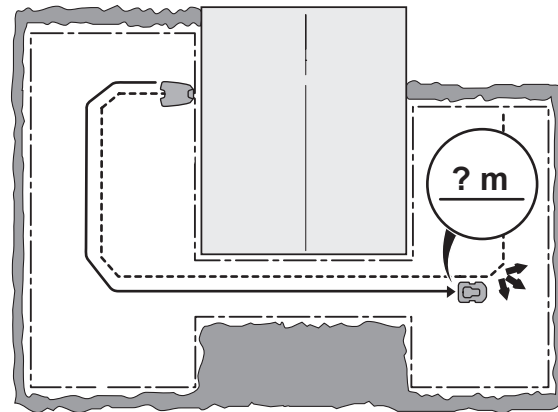

3023-018

Area X > How often?

How often the robotic lawnmower must be steered to the remote area is selected as a proportion of the total number of times it leaves the charging station. At all other times, the robotic lawnmower starts to mow at the charging station.

Select the percentage that corresponds to the size of the remote area relative to the total working area. If the remote area is for instance half of the total working area, 50 % must be selected. A lower figure must be specified if the remote area is smaller. If more areas are used, take into account that the total figure cannot exceed 100 %.

Compare with the examples in *see 7 Yard Examples on page 69*.

Use the number keys to specify share as a percentage.

The factory setting for Automower® 420 is 20% for Guide 1.

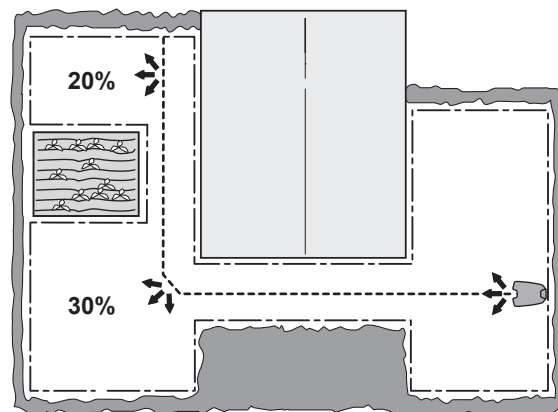

3023-019

Area X > Disable

With this function, the selected area settings can be deactivated.





MENU FUNCTIONS

Area X > More > Test

Testing selected settings can be seen as a natural part of the installation.

Using the *Test* function, the robotic lawnmower travels the farthest distance from the loop allowed by the selected corridor width.

To test the selected settings:

1. Place the robotic lawnmower in the charging station.
2. Use the down and the right/left arrow keys to select *Test* under the area to be tested. Press **OK**.
3. Press **START** and close the display hatch.
4. The robotic lawnmower will now leave the charging station and begin following the specified loop toward the remote area. Check that the robotic lawnmower can follow the loop all along the required distance.
5. The test is approved when the robotic lawnmower can follow the selected loop to the required starting point without any problem.

How to measure the distance to a remote area:

1. Park the robotic lawnmower in the charging station.
2. In the *Area X > How far?* menu function, enter a distance that beyond any doubt exceeds the actual figure. The maximum distance that can be entered is 500 m / 1 640 ft.
3. Select *Area X > More > Test* and press **OK**.
4. Press **START** and close the display hatch.
5. Press **STOP** in the desired position and measure the distance on the display. This value can now be saved in *Area > How long?*

Area X > More > Reset

Lawn coverage can be reset to the factory setting using this function. The factory setting is *Area 1* activated with the following settings:

- *How?* = Guide 1
- *How often?* = 20 %
- *How far?* = 300 m

The same factory setting also applies to *Area 2* and *Area 3* for Automower® 430X and Automower® 450X.



MENU FUNCTIONS

Find charging station

The robotic lawnmower can be set to search for the charging station in one or more of the following three ways: *Guide*, *Boundary Wire* and *Charging Station*. The factory settings are that these three search options are automatically combined to find the charging station as quickly as possible but also with a minimum risk of tracks forming.

In very complex yards e.g. with many areas joined by narrow passages, the amount of time required to find the charging station is decreased by carrying out a number of the manual setting outlined below.

The robotic lawnmower always starts the search for the charging station using an irregular search method.

When the robotic lawnmower still cannot find the charging station after a specific period of irregular searching, it also starts to search for the guide wires and after a further period also the boundary wire to follow one of them into the charging station instead. This time is specified in minutes and is known as delay time.

Example:

4 minute delay for Guide 1 and Guide 2 and 11 minutes for the boundary wire. The robotic lawnmower then searches irregularly for 4 minutes and then also searches for the guide wires for 7 minutes. If it has not found a guide wire after this period, the robotic lawnmower now also searches for the boundary loop.

It is possible of course to specify the same delay time for both the guide wires and boundary wire, for instance 5 minutes. The robotic lawnmower then searches irregularly for 5 minutes and when it does not find the charging station, it continues to search either by following the guide wires or the boundary wire, depending on which one it reaches first.

In general a long delay time decreases the risk of tracks forming (the robotic lawnmower will find the charging station more often through irregular searches) but gives longer search times. A short delay time gives the opposite effect, i.e. short search times with increased risk of tracks forming along the guide wires and/or boundary wires.

It is also possible to test that the robotic lawnmower can follow the guide wires and the boundary wire to the charging station and dock with it without a problem.

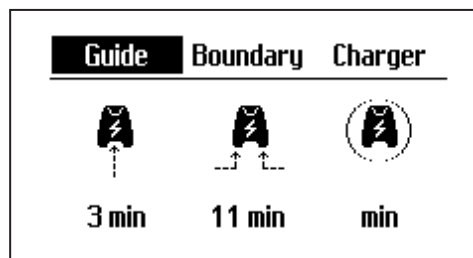

3012-1441

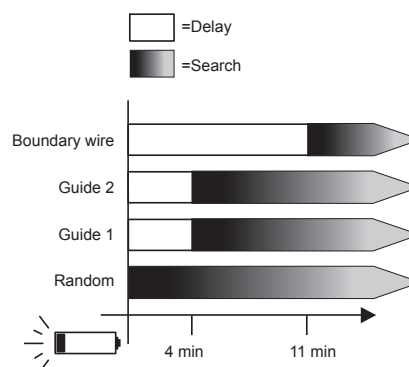

3012-1089





MENU FUNCTIONS

Guide

Make sure *Guide* is checked. Otherwise use the right or left arrow keys for marking and press **OK**.

Use the number keys to enter the delay time.

Automower® 450X can have up to three guide wires and Automower® 430X up to two guide wires.

Automower® 420 has only one guide wire.

Guide > Guide 1 delay

Move the cursor to *Delay Guide 1* and enter the delay in minutes.

The delay is normally specified as a figure between 0 and 10 minutes. Repeat this procedure if more than one guide is being connected.

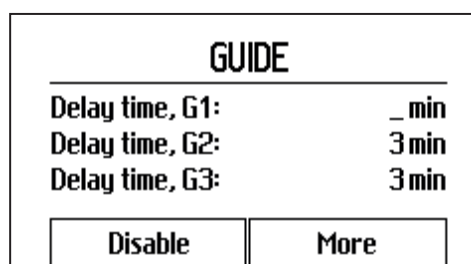

3012-1442

Boundary wire

Make sure the *Follow boundary home* checkbox is marked. Otherwise use the right or left arrow keys for marking and press **OK**.

Use the number keys to enter the delay time.

Move the cursor to *Delay time* and enter the delay in minutes.

This time is normally longer than for any of the guides as it is normally better if the robotic lawnmower follows one of the guide wires home to the charging station. The delay time is normally specified as a figure between 10 and 20 minutes but can be shorter if a guide wire is not installed and it is unlikely that the robotic lawnmower can find the charging station through an irregular search.

If the robotic lawnmower passes a guide wire when it is following the boundary wire, it will interrupt the search along the boundary wire and instead start following the guide wire to the charging station.

If it is strictly inappropriate in the installation to follow the boundary wire, the *Follow boundary home* checkbox must be deactivated.

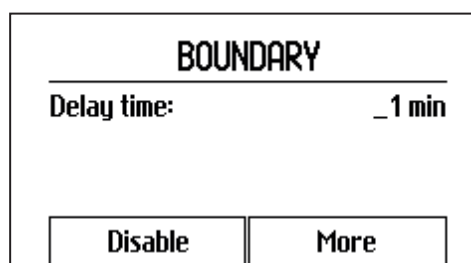

3012-1413

Charging station range

There may be reasons to reduce the range of the charging station in rare cases. It may be necessary if for instance the charging station is placed close to a bush or wall which prevents the robotic lawnmower from docking with the charging station despite making contact with the charging station's signals. In these cases, it is normally better to move the charging station, but if this is not possible, the range of the charging station can be reduced.

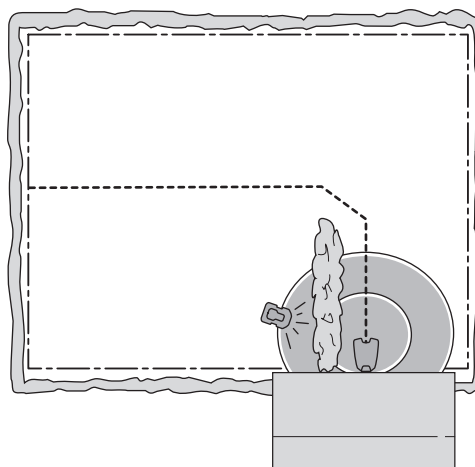

3023-040



MENU FUNCTIONS

Use the left and right arrow keys to select range.

Setting	Range
Min	0 m
Medium	approx. 3 to 4 m
Max	approx. 6 to 8 m

IMPORTANT INFORMATION

The charging station's range must only reduced in exceptional cases. It is normally better to move the charging station to a better place in the working area.

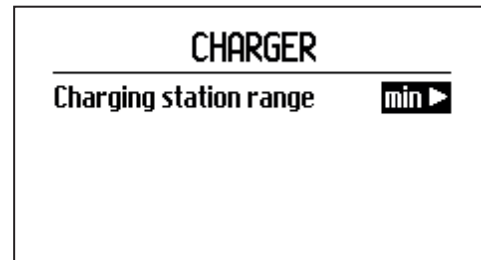

3012-1415

More > Test

Testing selected settings can be seen as a natural part of the installation.

To test the selected settings:

1. Place the robotic lawnmower about 3 m / 10 ft from the wire to be tested (boundary wire or one of the guide wires), facing the wire.
2. Use the right/left arrow key to select *Test* under the wire to be tested. Press **OK**.
3. Press **START** and close the display hatch.

Check that the robotic lawnmower follows the guide wire all the way to the charging station and that it docks with the charging station. The test is approved only if the robotic lawnmower is able to follow the guide wire the entire distance to the charging station and docks at the first attempt. If the robotic lawnmower is unable to dock on the first attempt, it will automatically try again. The installation is not approved if the robotic lawnmower needs two or more attempts to dock with the charging station.

Normal causes as to why the robotic lawnmower cannot follow the wire are that obstacles close to the wire have not been isolated or that the guide wire has not been laid at an angle on a steep slope. Check that the charging station, boundary wire and guide wire are installed in accordance with the instructions in Chapters 3.2, 3.4 and 3.6. If manual settings are done, the wrong corridor width may also have been selected.

4. The test is approved when the robotic lawnmower can follow the selected wire to the charging station and dock with it on the first attempt without any problems.

Using *Test*, the robotic lawnmower travels the maximum distance from the wire defined by the selected corridor width.



MENU FUNCTIONS

Advanced

Under the *Advanced* heading, there are even more settings relating to the behavior of the robotic lawnmower. The settings in this menu are only required if additional control of the lawnmower is definitely needed e.g. in very complex yards. The factory settings are selected in way that should suit most working areas.

Corridor width

The corridor width is a measure of how far from the guide wire/boundary wire the robotic lawnmower is allowed to travel when it follows this to and from the charging station. The area beside the wire which the robotic lawnmower then uses is called the Corridor.

The aim of operating at varying distances from the wire is reduce the risk of tracks forming. To reduce the risk of tracks forming, it is recommended to select the widest corridor possible allowed by the size of the working area.

The robotic lawnmower adapts the corridor according to the shape of the working area when it follows along the guide wire. The inbuilt automatic mechanism allows the robotic lawnmower to vary the distance from the guide wire depending on where in the working area it is located. It automatically makes the corridor narrower in narrow passages for instance.

The factory settings can be used for many working areas, i.e. the robotic lawnmower itself can use the inbuilt functions to operate in the widest possible corridor. In more complex yards e.g. where the guide wire is placed close to obstacles which cannot be isolated using the boundary loop, operational safety can be improved by carrying out some of the manual settings outlined below.

Corridor width > Boundary

Corridor width is specified in intervals from 1-9. The first number in the interval specifies the shortest distance to the boundary loop and the second number the longest distance.

The distance the robotic lawnmower maintains from the boundary loop varies depending on the layout of the working area. Use the *Test* function in *Installation > Lawn Coverage > Overview* to test the different values.

Use the number keys to specify the required interval.

The factory setting is 3-6.

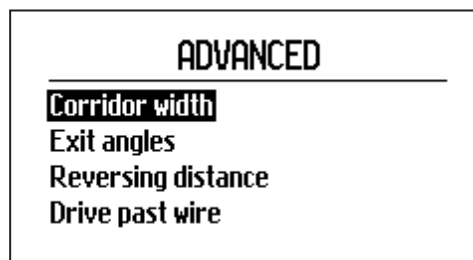

3012-1249

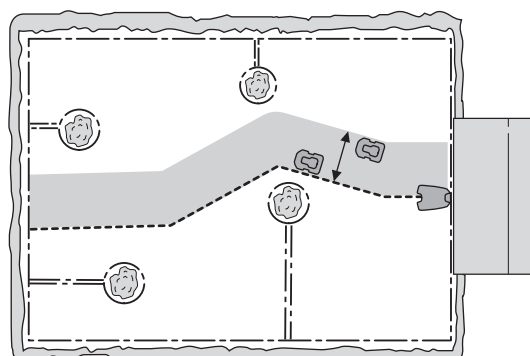

3023-020

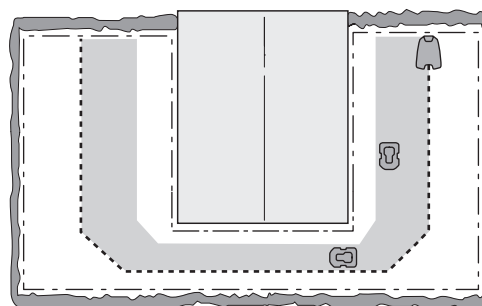

3012-021

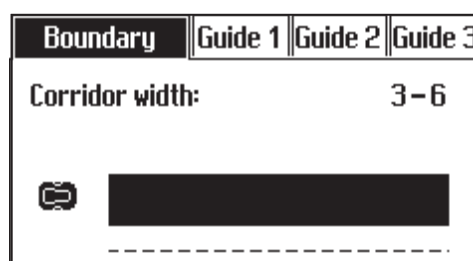

3012-1444



MENU FUNCTIONS

Corridor width > Guide

The Automatic passage management function automatically adjusts the width of the guide corridor. The maximum corridor width can also be changed manually. The corridor width can be set to between 0 and 9.

If value 0 is specified, the robotic lawnmower will straddle the guide wire meaning it runs right over the middle of the guide wire.

Use the arrow keys to specify the required value.

The factory setting is 9.

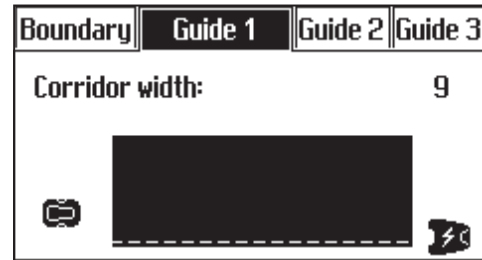

3012-1446

Exit angles

Normally the robotic lawnmower leaves the charging station in a direction within the 90°-270° exit sector. By changing the exit angles, it makes it easier for the robotic lawnmower to reach the largest working area if the charging station is placed in a passage.

Exit angles > Sectors

The robotic lawnmower can be set for one or two exit sectors. If the charging station is placed in a passage, two exit angles, for instance 70°-110° and 250°-290°, can be used.

When two exit angles are used, there is a need to also specify how often the robotic lawnmower must leave the charging station in sector 1. This is done using the *Proportion first* function by specifying a percentage.

For instance 75 % means that the robotic lawnmower leaves the charging station in *Sector 1* on 75 % of the times and 25 % of the times in sector 2.

Use the number keys to specify the required angles in degrees for the sectors and proportion as a percentage.

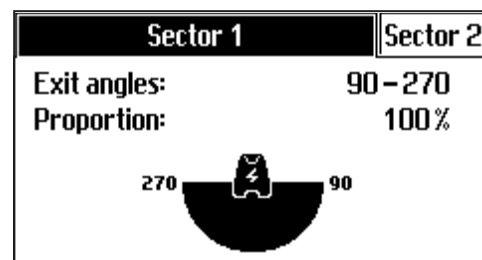

3012-1418

Reversing distance

This functions allows you to control how far the robotic lawnmower has to reverse out of the charging station before it starts mowing. This is a useful function, for instance, if the charging station is placed a long way in under a veranda or in another limited space area.

Use the number keys to specify the required reverse distance in centimeters and press **OK**.

Drive past wire

The front of the robotic lawnmower always passes the boundary wire by a specific distance before the mower turns around. The default distance is 31 cm / 12.2", but this can be changed if required. A figure between 20 and 50 can be selected.

Note that the distance given is only an approximate value and should be regarded as a guide. In reality, the actual distance the robotic mower passes the boundary wire can vary.

Specify the number of centimeters you want the robotic lawnmower to pass the boundary wire and press **OK**.

English - 60

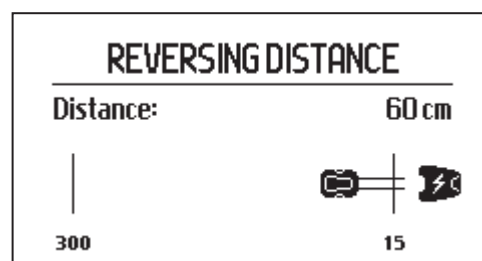

3012-1419

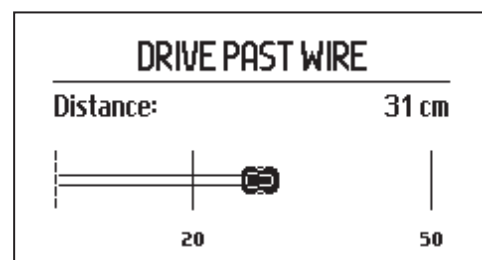

3012-1447

MENU FUNCTIONS

6.9 Settings

This selection allows you to carry out changes to the robotic lawnmower's general settings.

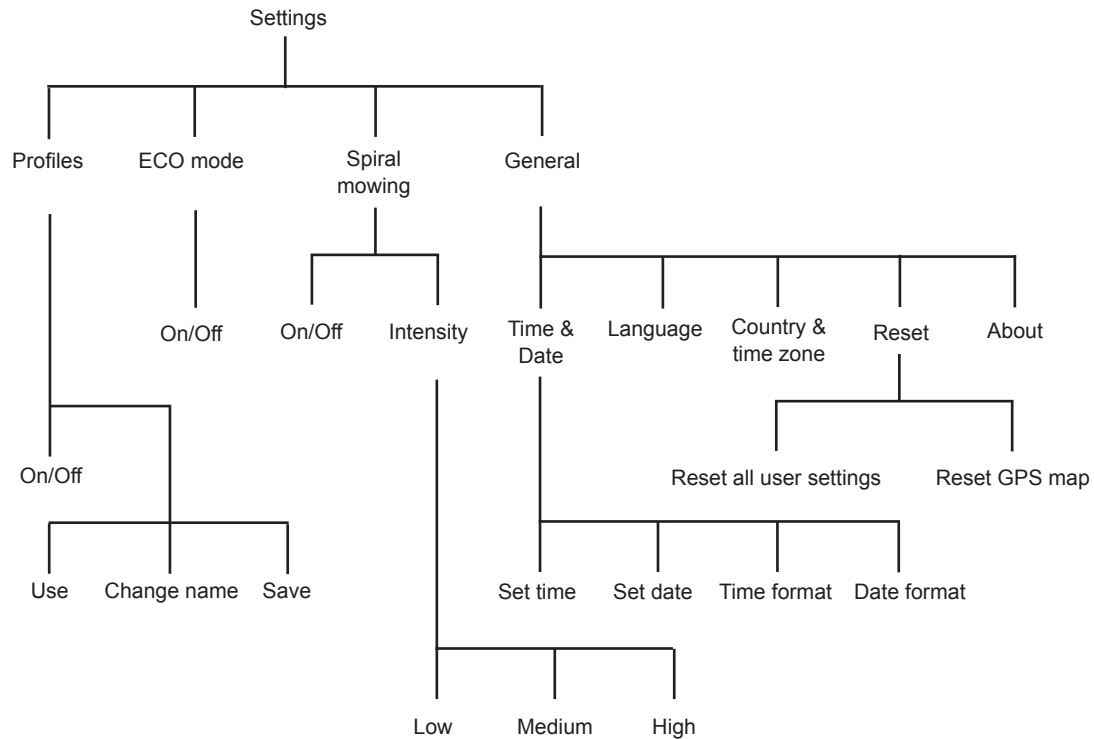

Profiles

The *Profiles* function can be used to save different sets of user settings. This means the settings can easily be saved and reused, for example if the robotic mower is to be used on several yards. Up to three different profiles can be saved.

Save settings to a Profile

- First make the mower settings to save in the profile.
- Select *Profiles* and press **OK**.
- Select the profile to save, change the selection up and down with the arrow keys.
- Press **OK**.
- Select *Save* and press **OK** followed by the right arrow key and **OK**. All user settings will now be saved and activated in the selected profile.
- If profile settings have been made but not saved, the * symbol will be displayed next to the profile name.

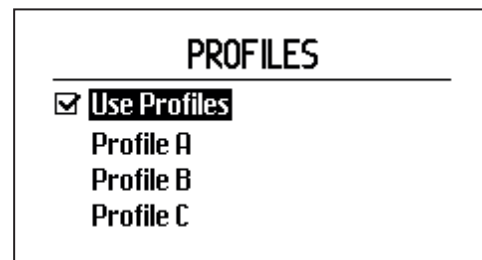

3012-1421

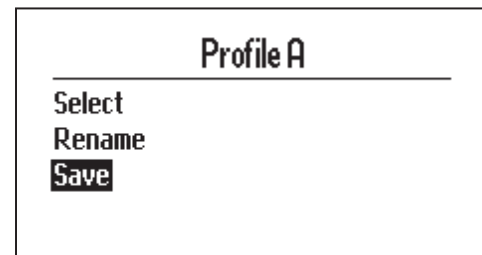

3012-1425

MENU FUNCTIONS

Change the name of a Profile

Profile names can be changed so it is easier to remember what settings have been saved in the respective profile.

- Select the Profile name to be changed
- Press **OK**
- Select *Rename* in the menu and press **OK**.
- Move the cursor with the arrow keys. Press **OK** to select a letter. Press **BACK** to save the new name.
- Profile names can be seen in the *Settings - Profiles* menu. The name of the selected profile can also be seen on the start page.

Name: NEW

A	B	C	D	E	F	G	H	I	J	K	L	M	N	O
P	Q	R	S	T	U	V	W	X	Y	Z	0	1	2	3
4	5	6	7	8	9	À	Á	Â	Ã	Ä	Å	Æ	Ç	Ď
È	É	Ê	Ë	Ě	İ	Í	Ĭ	Ń	Ň	Ò	Ó	Ô	Õ	Ø
Ř	Š	ß	Ť	Ù	Ú	Û	Ü	Ý	Ž	-	.	_		

3012-575

Use a Profile

Do the following to activate and use a profile and thereby use the settings that have been saved.

- Mark the profile to activate.
- Press **OK**.
- Select *Select* and press **OK**.

The robotic lawnmower will now use the settings that were saved in the profile.

PROFILE A

Select

Rename

Save

3012-576

One Automower® for several yards

The unique coupling between mower and charging station is saved in the profiles. This allows up to three different charging stations to be coupled to the same robotic lawnmower.

Coupling a new charging station to the robotic lawnmower:

- First save a profile to be used with the original charging station.
- Then place the mower in the new charging station being coupled to the mower.
- Select *New loop signal*, see 6.5 Security on page 47.
- Save a profile for the new charging station.

In order to use the robotic lawnmower in the original charging station, the first profile must now be selected. In order to use the robotic lawnmower in the new charging station, the new profile must now be selected.

To give the best function, GPS assisted navigation should be disabled for all extra installations and only be used for the main installation. To turn off GPS assisted navigation, see 6.8 Installation on page 51.



MENU FUNCTIONS

ECO

This function automatically turns off the loop signal in the boundary loop, the guide wires and the charging station when the robotic lawnmower is not mowing, i.e. when the lawnmower is charging or is not allowed to mow due to timer settings.

ECO is suitable to use where there is other wireless equipment not compatible with the robotic lawnmower e.g. certain hearing loops or garage doors.

When the loop signal is turned off due to the ECO mode, the indicator lamp in the charging station flashes green. When the indicator lamp flashes green the robotic lawnmower can only be started in the charging station and not out in the working area.

In ECO mode, it is very important to always press the STOP button before removing the robotic lawnmower from the charging station. In ECO mode it is otherwise not possible to start the robotic lawnmower. If the lawnmower has been removed by mistake without first pressing the STOP button, the lawnmower must be placed back in the charging station and the STOP button pressed. Only then can the robotic lawnmower be started inside the working area.

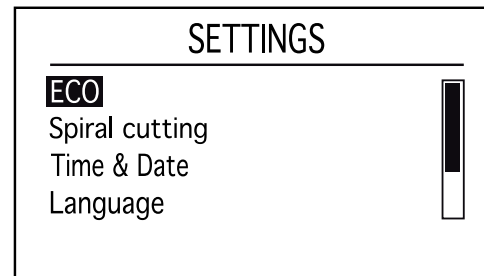

3012-1256

IMPORTANT INFORMATION

Always press the STOP button before removing the robotic lawnmower from the charging station. In ECO mode the robotic lawnmower otherwise will not start inside the working area.

Select *ECO mode* and press **OK** to activate ECO mode.

Spiral cutting

If the robotic lawnmower enters an area where it senses the grass is longer than average, it can change the movement pattern. It can then mow in a spiral pattern to faster cut the area of longer grass.

Spiral cutting

To deactivate spiral cutting, uncheck *Spiral cutting* and press **OK**.

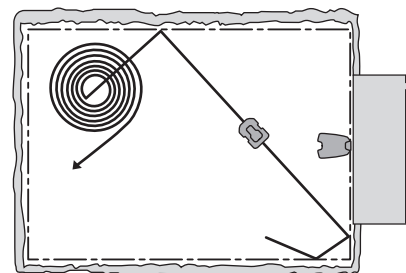

3023-041

Intensity

The level of sensitivity can be adjusted to set how much over the average height the grass has to be for spiral cutting to begin.

Low sensitivity means that spiral cutting begins less often. High sensitivity means that spiral cutting begins more often.





MENU FUNCTIONS

General

Time & Date

This function allows you to set current time and required time format in the robotic lawnmower.

Set time

Enter the correct time and press **OK** to exit.

Time format

Move the cursor to the required time format: 12h/24h. Finish by pressing **OK**.

Set date

Enter current date and press **OK** to exit.

Date format

Place the cursor at the required date format:

YYYY-MM-DD (year-month-day)

MM-DD-YYYY (month-day-year)

DD-MM-YYYY (day-month-year).

Exit by pressing **OK**.

Language

With this function, you can select the language that is displayed in the menus. Place the cursor on the desired language and press **OK**.

Country and time zone

Select the country in which the robotic lawnmower will operate with this function. Place the cursor at the required country and press **OK**.

Restore factory settings

Reset all user settings

This function allows you to reset the robotic lawnmower to the default settings it had when it left the factory.

The following settings are not altered:

- Security level
- PIN Code
- Loop signal
- Messages
- Date & Time
- Language
- Country

1. Select *Reset user settings* in the menu and press **OK**.
2. Confirm by pressing **OK**.





MENU FUNCTIONS

Reset GPS map

For Automower® 430X and Automower® 450X only.

The GPS map used by the robotic lawnmower in GPS assisted navigation may require resetting, if the mower's working area is changed, for example.

To reset the map:

1. Select *Reset GPS map* in the menu and press **OK**.
2. Confirm by pressing **OK**.

About

The *About* menu displays information about the robotic lawnmower model, serial number and the various software.

6.10 Accessories

Settings for accessories mounted on the mower can be made in this menu.

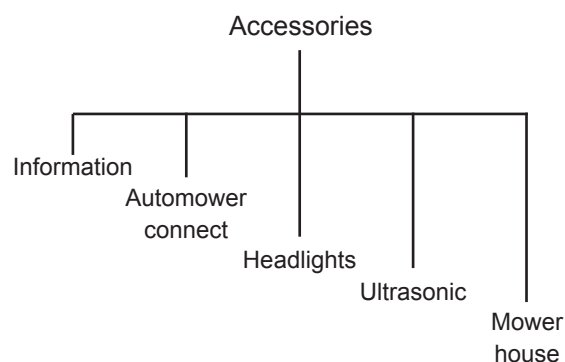

Information

This menu handles accessories mounted on the mower. Get in touch with your local dealer for more information concerning the accessories that are available.

Automower Connect

Automower® Connect is preset as standard on the Automower® 450X. It can be installed as an accessory on Automower® 430X and 420. Contact the local dealer.

Download the Connect app

Scan the QR code on the back of the manual with your smartphone to download your free app. You can also download the app from the AppStore or GooglePlay.

Create a Connect account

Once you have downloaded your app, you can specify a valid e-mail address and a password to create a Connect account. You will receive a validation e-mail to the e-mail address you specified. Follow the instructions in the e-mail within 48 hours to validate your account. If not validated within 48 hours, you will have to create your account again.



MENU FUNCTIONS

Pair the robotic lawnmower with the account

The robotic lawnmower can be paired with the account after the account has been created in the app. When the app prompts you to do so, enter the 6-digit code shown on the robotic lawnmower display after selecting the function Accessories > Automower Connect (mower PIN required) > Pairing > New pairing. Also enter the name of the mower into the app.

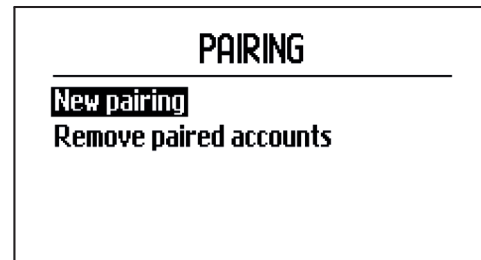

3012-1450

Activate GeoFence origin

Before GeoFence can be used, its center point (origin) and sensitivity must be set. This can be done only from the mower menu.

Place the mower centrally in your yard. Select Accessories > Automower Connect (robotic lawnmower PIN required) > GeoFence. Activate the function by selecting Activate GeoFence and pressing OK. Select New center point to set the origin for GeoFence. GeoFence sensitivity can be changed to suit your yard. Sensitivity can be set to low, medium or high. The higher the sensitivity, the easier the alarm is activated. If the alarm is activated too easily, when a false alarm is given inside the yard for example, you should select a lower setting for the GeoFence sensitivity.

When putting the robotic lawnmower into storage for a long period, such as during the winter, we recommend turning off the main switch. With the GeoFence function activated, you will need the PIN code in order to turn off the robotic lawnmower. Once the main switch has been turned off, the Connect function will stay active for another 12 hours. It will then not be possible to communicate with the robotic lawnmower and the GeoFence function will not be active.

Status icons in the robotic lawnmower

With Automower® Connect activated, new icons will be displayed on the robotic lawnmower's idling screen.

 The bars show the signal strength of the GPRS reception.

 An X next to the bars indicates a problem has arisen concerning the connection with the Internet server.

 The SIM symbol indicates there is a problem with the SIM card or the module. Make sure the SIM card support 2G data communication, that there is sufficient funds on the card (applies to pre-paid SIM cards) and that the APN settings agree.



MENU FUNCTIONS

Connect app functions

Main menu

- **Status:** Shows detailed robotic lawnmower status and you can send commands to the robotic lawnmower.
- **GeoFence:** The house pin on the map shows the starting point of the robotic lawnmower. A circle around the house pin indicates the radius of the GeoFence. The second pin on the map shows the actual position of the robotic lawnmower. You can track the movement of the robotic lawnmower with this feature, e.g. in case of theft. Click the pin to show the robotic lawnmower coordinates.
- **Adjustment:** Display and change all available settings in the mower menu, with the exception of the security settings.

My robotic lawnmowers

Displays the status of and allows you to manage all the robotic lawnmowers coupled to the account as well as add new ones.

With a non-smartphone (SMS only)

SMS settings

The SMS function must be activated from the mower menu before it can be used. Select Accessories > Automower Connect (robotic lawnmower PIN required) > Communication > Use SMS. The telephone numbers to the mobiles allowed to communicate via SMS must be entered into the list of SMS numbers. The numbers must be entered with their country codes, e.g. (+)46701234567. Use the Test-SMS function to verify the specified telephone number. A text will then be sent to all the telephone numbers on the list. The list can have up to three numbers.

SMS commands

With the SMS function activated, an SMS will be sent to all the telephone number in the list if the mower is found outside the GeoFence. Certain information can also be retrieved from the robotic lawnmower by sending it an SMS. An SMS with the command "GET GPS INFO" to the mower will give information concerning its position, the origin of GeoFence and its radius together with the GPS signal strength. Note that the telephone of the sender must be specified in the robotic lawnmower. A maximum of 10 SMS per month can be sent from the mower.

MENU FUNCTIONS

Headlights

Automower® 430X and Automower® 450X.

Settings concerning the headlights are made using this function. The headlights are fitted as an accessory on the Automower® 430X.

Schedule

Select when to turn on the headlights in the Schedule sub-menu. Choose between Always ON, Evening only, Evening & night or Always OFF.

The headlights are turned on/off for the various schedule alternatives on the following occasions:

	On	Off
Evenings only	At sunset	Midnight
Evenings and nights	At sunset	At sunrise

Flashes when fault

If Flashes when fault is activated the headlights will flash if the robotic lawnmower has come to a standstill because of a fault.

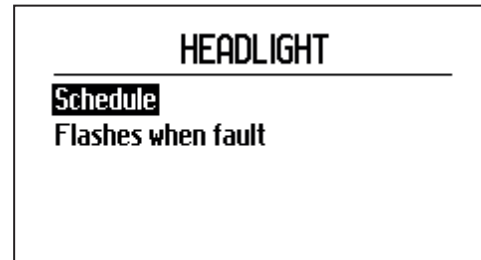

3012-1448

Ultrasonic

Automower® 450X.

Ultrasonic ensures the mower reduces speed before it crashes with an obstacle. This function can be turned off, which means the mower will always operate at low speed.

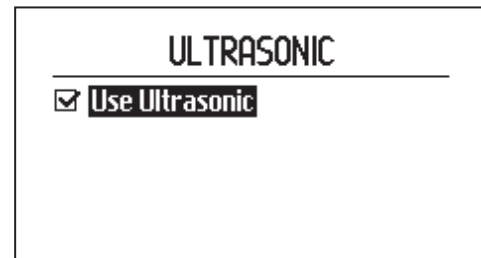

3012-1449

Mower house

Settings concerning the mower house are made using this function.

Avoid collisions with mower house

Choosing this alternative reduces wear on the mower and house, but it can mean more unmown grass around the charging station.

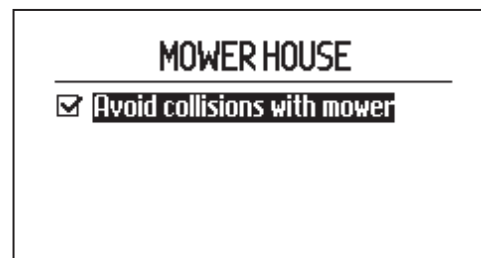

3012-1433



YARD EXAMPLES

7 Yard Examples

- Proposed Installation and Settings

Adapting the robotic lawnmower's settings and guide wire positions according to the shape of the yard makes it easier for the robotic lawnmower to frequently reach all parts of the yard and in doing so achieve a perfect mowing result.

Different yards may require different settings. The following pages outline a number of examples of yards with installation and setting proposals.

For more detailed information about the various settings, see *6 Menu Functions on page 41*.

There is more installation help on www.automower.com.

IMPORTANT INFORMATION

The default setting for the robotic lawnmower has been chosen to work in as many different yards as possible. The settings only need to be adjusted when special installation conditions exist.

The recommended timer settings in the following yard examples are applicable to Automower® 420. The operating time of the Automower® 430X and 450X can be reduced as they are high-performance. See 6.3 Timer page 43 for a detailed calculation of the operating times for the various models.

YARD EXAMPLES

Proposed Installation and Settings	
<i>Area</i>	150 m ² / 0.04 acre. Open and level area.
<i>Timer</i>	08:00–12:00 Monday, Wednesday, Friday
<i>Lawn coverage</i>	Factory setting
<i>Find charging station</i>	Factory setting
<i>Comments</i>	<p>The timer should be used to prevent the grass looking trampled since the area is significantly less than the maximum capacity of the robotic lawnmower.</p> <p>As the area is open and uncomplicated there is no need for a guide wire in this installation.</p>
<i>Area</i>	500 m ² / 0.12 acre. A number of islands and a 35 % slope.
<i>Timer</i>	08:00–16:00 Monday, Tuesday, Thursday, Friday, Saturday
<i>Lawn coverage</i>	Factory setting
<i>Find charging station</i>	Factory setting
<i>Comments</i>	Lay the guide wire at an angle over the steep slope.

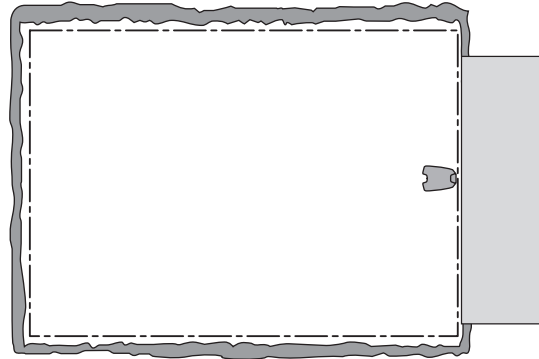

3023-032

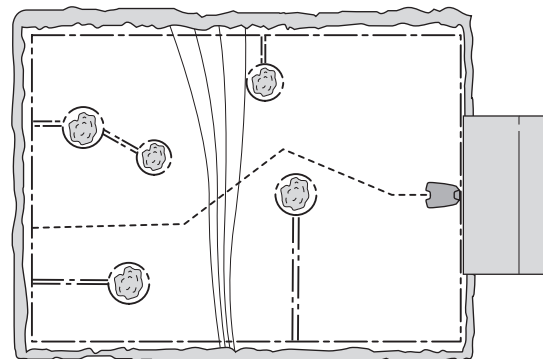

3023-023

MENU FUNCTIONS

Area	800 m ² / 0.2 acre. L-shaped yard with charging station installed in the narrow area. Contains a couple of islands.
Timer	08:00–20:00 Monday, Tuesday, Thursday, Friday, Saturday
Lawn coverage	Automower® 420: Guide 1 <i>Proportion</i> 60 % Automower® 430X and 450X: Factory setting
Find charging station	Factory setting
Comments	The <i>Proportion</i> for Guide 1 must be specified as a value corresponding to the largest part of the working area as most of the working area can easily be reached by the robotic lawnmower following the guide wire out from the charging station. The factory setting for Automower® 430X and 450X can be used, as the <i>GPS assisted navigation</i> automatically carries out the necessary settings.
Area	1000 m ² / 0.25 acre. U-shaped yard linked with a narrow passage.
Timer	08:00–22:00, Monday–Saturday
Lawn coverage	Automower® 420: Guide 1 <i>Proportion</i> 40% Automower® 430X and 450X: Factory setting
Find charging station	Factory setting
Comments	The guide wire must be placed along the narrow passage to ensure the robotic lawnmower can with ease locate the left hand side of the working area. <i>Proportion 40 %</i> is selected as the left hand area is nearly half of the total area. The factory setting for Automower® 430X and 450X can be used, as the <i>GPS assisted navigation</i> automatically carries out the necessary settings.

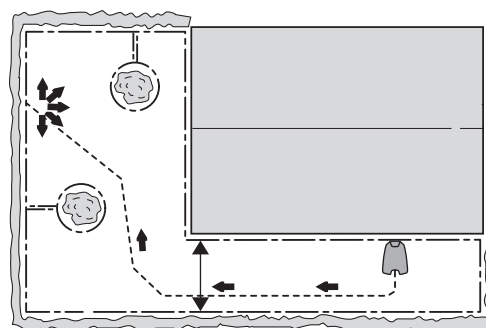

3023-024

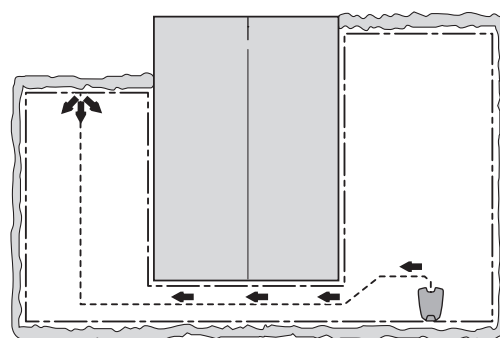

3023-025

MENU FUNCTIONS

Area	800 m ² / 0.2 acre. Unsymmetrical working area with a narrow passage and a number of islands.
Timer	08:00-20:00 Monday, Tuesday, Thursday, Friday, Saturday
Lawn coverage	Automower® 420: Area 1 Guide 1 Proportion 30 % Automower® 430X and 450X: Factory setting
Find charging station	Factory setting
Comments	The guide wire must be placed along the narrow passage to ensure that the robotic lawnmower can with ease locate the charging station from the right hand side of the working area. As the right hand area is only a small part of the working area, the <i>Lawn coverage</i> factory settings can be used.
Area	800 m ² . Three areas linked with two narrow passages.
Timer	08:00-20:00 Monday, Tuesday, Thursday, Friday, Saturday
Lawn coverage	Automower® 420: Area 1 Guide 1 Proportion 25% Area 2 Guide 1 Proportion 25% Automower® 430X and 450X: Factory setting
Find charging station	Factory setting
Comments	As the working area contains several areas linked by narrow passages, <i>Lawn coverage</i> must be used to create several areas to obtain an even mowing result across the entire working area. The factory setting for Automower® 430X and 450X can be used, as the <i>GPS assisted navigation</i> automatically carries out the necessary settings.

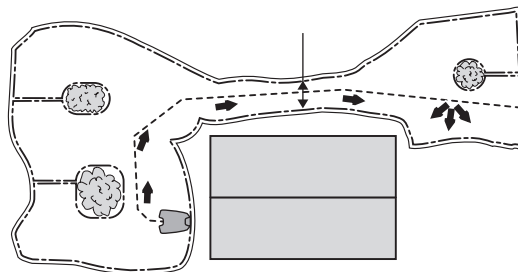

3023-026

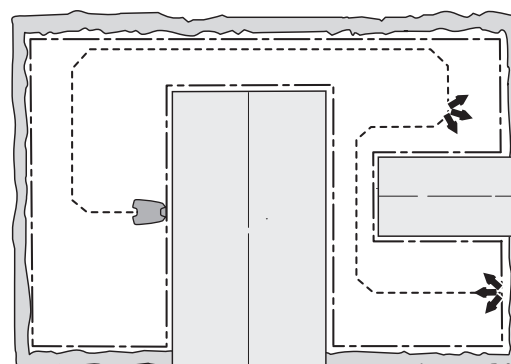

3023-027

MAINTENANCE

Area	NB! This example applies to Automower® 430X and 450X only. 1000 m ² / 0.25 acre. Three areas of which two smaller areas are connected with the larger one, each by a narrow passage.
Timer	08:00-22:00 Monday-Saturday
Lawn coverage	Factory setting
Find charging station	Factory setting
Comments	As the installation requires 2 guide wires, this working area is not suitable for Automower® 420.
Area	500 m ² / 0.12 acre + 100 m ² / 0.025acre in a secondary area.
Timer	08:00–16:00 Monday, Tuesday, Thursday, Friday, Saturday
Lawn coverage	Factory setting
Find charging station	Factory setting
Comments	The secondary area is cut using the <i>Secondary area</i> mode on Wednesdays and Sundays. As the area is open and uncomplicated there is no need for a guide wire in this installation.

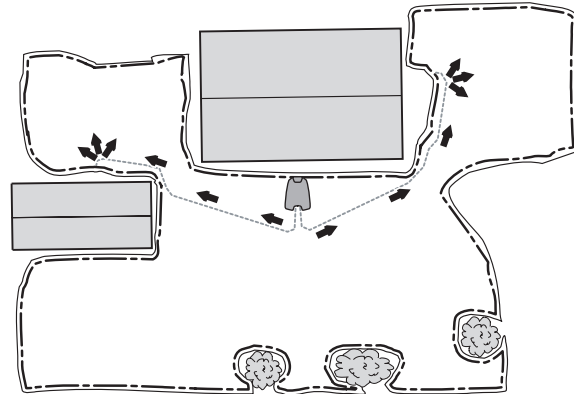

3023-046

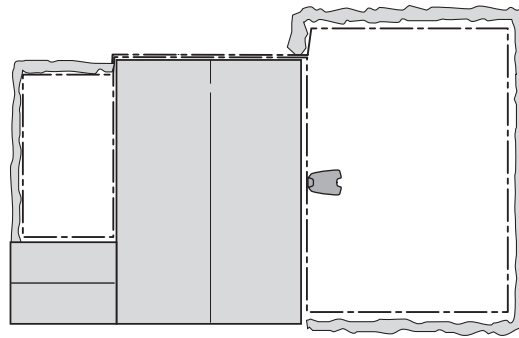

3023-033

8 Maintenance

Check and clean the robotic lawnmower regularly and replace worn parts if necessary to improve operating reliability and to ensure a longer service life. For further information on cleaning, see *8.4 Cleaning on page 76*.

When the robotic lawnmower is first used, the blade disc and blades should be inspected once a week. If the amount of wear during this period has been low, the inspection interval can be increased.

It is important that the blade disc rotates easily. The edges of the blades should not be damaged. The service life of the blades varies immensely and depends for instance on:

- Operating time and size of the working area.
- Type of grass.
- Type of soil.
- The presence of objects such as cones, windfalls, toys, tools, stones, roots and the like.

The normal service life is 2 to 6 weeks when used in areas more than 1 500 m² / 0.4 acre in size and longer for smaller areas. To replace the blades, see *8.7 Blades on page 78*.

IMPORTANT INFORMATION

Working with dull blades gives a poorer mowing result. The grass is not cut cleanly and more energy is needed resulting in the robotic lawnmower not mowing such a large area.

MAINTENANCE

8.1 Winter Storage

The robotic lawnmower

The robotic lawnmower must be carefully cleaned before winter storage, see 8.4 *Cleaning* on page 76.

To guarantee battery functionality and service life, it is very important to fully charge the robotic lawnmower before storing it away for the winter. Place the robotic lawnmower in the charging station with the hatch open until the battery icon in the display shows that the battery is fully charged. Then set the main switch to 0.

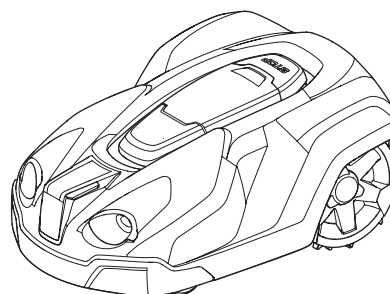

3012-1040

IMPORTANT INFORMATION

The battery must be charged fully before winter storage. If the battery is not fully charged it can be damaged and in certain cases be rendered useless.

Check the condition of wear items such as blades and bearings in the front wheels. Rectify if necessary to make sure the robotic lawnmower is in good condition prior to next season.

Store the robotic lawnmower in a dry and frost-free environment. A wall hanger produced especially for Automower® robotic lawnmower and charging station is available as an accessory. The wall hanger is perfect for winter storage. Contact your local dealer for more information.

Charging station

Store the charging station and power supply indoors. The boundary wire and the guide wire can be left in the ground. The ends of the wires should be protected from damp by connecting them to an original coupler or putting them in a container with grease for instance.

If it is not possible to store the charging station indoors, the charging station must be connected to the mains, the boundary wire and the guide wires the entire winter.

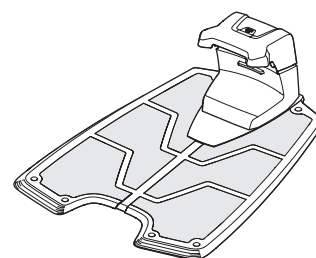

3012-1041

MAINTENANCE

8.2 Winter Service

Leave your robotic lawnmower with a dealer for service prior to winter storage. Regular winter service is a good way to maintain the robotic lawnmower in good condition over a long period of time and create the best conditions for a new season without any disruptions.

Service usually includes the following:

- Thorough cleaning of the body, the chassis, the blade disc and all other moving parts.
- Testing of the mower's function and components.
- Checking and if required replacement of wear items such as blades and bearings.
- Testing the mower's battery capacity as well as a recommendation to replace battery if necessary.

If necessary the dealer can also update the robotic lawnmower with new software, including new features where applicable.

8.3 After Winter Storage

Check whether the robotic lawnmower, contact strips or charging strips need to be cleaned before using. If the charging or contact strips appear to be burnt or coated, clean them using fine grade emery cloth. Check that the mower's time and date are correct.

8.4 Cleaning

It is important to keep the robotic lawnmower clean. A robotic lawnmower with a lot of grass stuck to it will find it harder to travel up slopes, perform worse and be exposed to greater wear and tear. It is recommended to clean using a soft brush.

IMPORTANT INFORMATION

Never use a high-pressure washer or even running water to clean the robotic lawnmower. Never use solvents for cleaning.

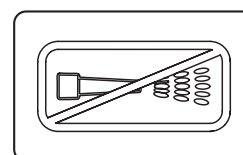

3018-062

MAINTENANCE

Chassis and Blade Disc

1. Set the main switch in 0 position.
2. Wear protective gloves.
3. Lift the robotic lawnmower onto its side.
4. Clean the blade disc and chassis using e.g. a dish brush.

Check at the same time that the skid plate rotates freely in relation to the blade disc.

If long blades of grass or other objects find their way in, these may impede the blade disc. Even a slight braking effect leads to a higher consumption of energy and longer mowing times, and at worst will prevent the robotic lawnmower from being able to mow a large lawn. The blade disc must be removed to carry out a more thorough cleaning. If necessary, get in touch with your local dealer.

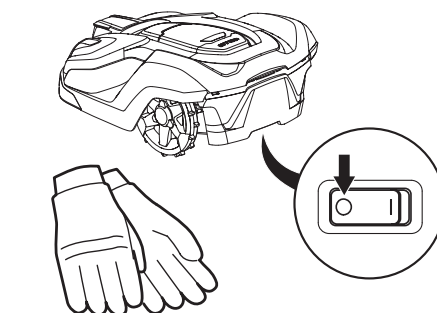

3012-1060

3012-272

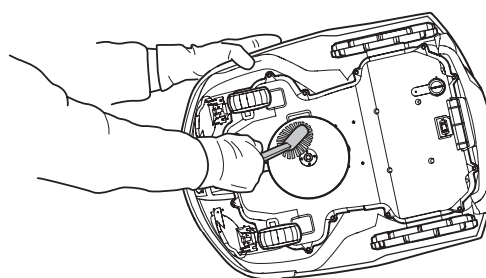

3012-1067

Chassis

Clean the underside of the chassis. Brush or wipe with a damp cloth.

Wheels

Clean around the front wheels and rear wheels as well as the front wheel suspension.

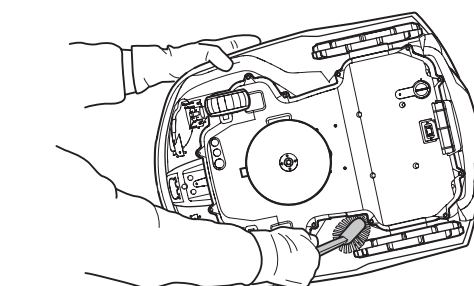

3012-1068

Body

Use a damp, soft sponge or cloth to clean the body. If the body is very dirty it may be necessary to use a soap solution or washing-up liquid.

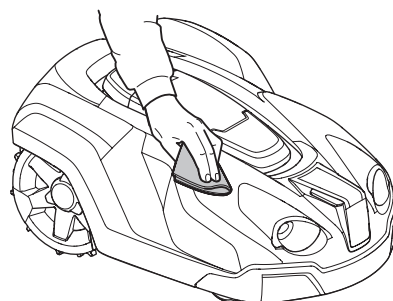

3012-1069

Charging Station

Clean the charging station regularly from grass, leaves, twigs and other objects that may impede docking.

8.5 Transport and Moving

Secure the machine during transport. It is important that the robotic lawnmower is kept still when it is being transported, for instance, between lawns.

The accompanying lithium ion batteries are covered by demands in legislation concerning hazardous goods.

Special requirements on packaging and marking must be followed for commercial transport with, for example, third parties or carriers.

An expert in hazardous goods must be consulted before preparing the transport of the subject. Any more detailed national regulations must also be observed.

Cover over any open connectors and pack the battery in such a way that it will not move in the packaging.

MAINTENANCE

8.6 In Case of Thunderstorms

To reduce the risk of damage to electrical components in the robotic lawnmower and its charging station, we recommend that all connections to the charging station are disconnected (power supply, boundary wire and guide wires) if there is a risk of a thunderstorm.

1. Ensure that cables are marked with the included markers to facilitate reconnection. The charging station's connections are marked AR, AL, G1, G2, G3.
2. Disconnect all wires.
3. Close the cover to the charging station to protect the connections from rain.
4. Connect all the wires if there is no longer a risk of thunder. It is important that each wire is connected to the right place.

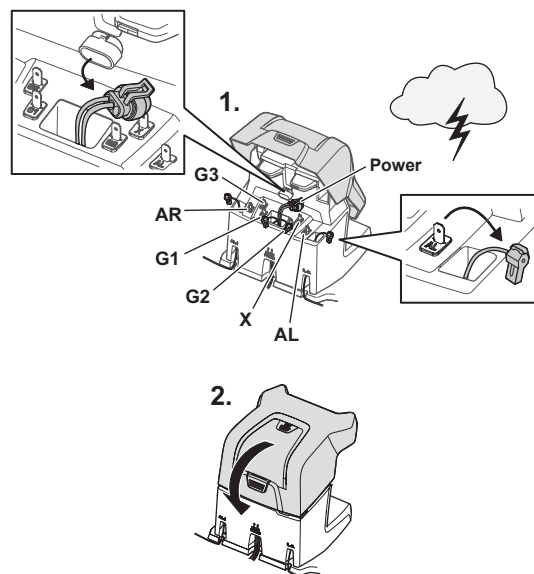

3012-1124

8.7 Blades



WARNING

Always use original blades and screws when replacing. Only replacing the blades and reusing the screw can result in the screw wearing during mowing and shearing off. The blades can then be thrown out and cause serious injury.

There are three blades on the robotic lawnmower, which are screwed into the blade disc. All three blades and screws must be replaced at the same time to obtain a balanced mowing system.

Use Husqvarna approved blades only. Contact your local dealer for more information.

To replace the blades:

1. Set the main switch to position 0.
2. Wear protective gloves.
3. Turn the robotic lawnmower upside down.
4. Rotate the skid plate so that its holes align with the screw for the blade.
5. Remove the screw. Use a straight slot or cross-tip screwdriver.
6. Remove the blade and the screw.
7. Screw on the new blade and the new screw. Check also that the blades can pivot freely.

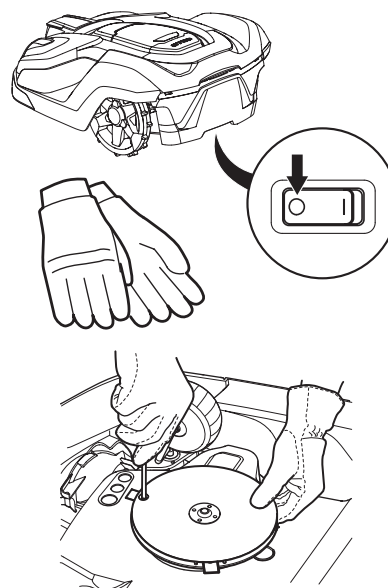

3012-1060

3012-272

3012-1207



MAINTENANCE

8.8 Battery

The battery is maintenance-free, but has a limited life span of 2 to 4 years.

Battery service life is dependent on the length of the season and how many hours a day the robotic lawnmower is used. A long season or many hours of use per day means that the battery must be replaced more regularly.

Contact your dealer to replace the battery.

Charge the battery in the included charging station only. Always use the original power supply unit. Incorrect usage can cause electrical shocks, overheating or leakage of corrosive liquid from the battery. In case of an electrolyte leak, rinse with water/neutralizing agent. Seek medical help if electrolyte comes into contact with eyes.

RELEASE NOTES

Do not try to recharge batteries that are not rechargeable.

TROUBLE SHOOTING

9 Trouble Shooting

In this chapter, we have listed a number of messages which may be shown in the display if there is a malfunction. There is a proposal as to the cause and steps to take for each message.

This chapter also presents some symptoms that can guide you if the robotic lawnmower does not work as expected.

More suggestions for steps to take in the event of malfunction or symptoms can be found on www.automower.com.

9.1 Fault Messages

A number of fault messages are listed below that can be shown on the display on the robotic lawnmower. Contact your local dealer if the same message appears often.

Message	Cause	Action
<i>Wheel motor blocked, left</i>	Grass or other object has wrapped around the drive wheel.	Check the drive wheel and remove the grass or other object.
<i>Wheel motor blocked, right</i>	Grass or other object has wrapped around the drive wheel.	
<i>Blade motor blocked</i>	Grass or other object has wrapped around the blade disc.	Check the blade disc and remove the grass or other object.
	The blade disc is lying in a pool of water.	Move the robotic lawnmower and if possible prevent the collection of water in the working area.
<i>Cutting height blocked</i>	Grass or other object has wrapped around the cutting height adjustment or between the blade disc and chassis.	Check the blade disc and the bellows around the cutting height adjustment and remove any grass or other objects that may have got stuck.
<i>No loop signal</i>	Power supply not connected.	Check the wall socket connection and whether an earth-fault breaker has tripped.
	The low voltage cable is damaged or not connected.	Check that the low voltage cable is not damaged. Also check that it is properly connected to the charging station and to the power supply.
	The boundary wire is not connected to the charging station	Check that the boundary wire connector is fitted properly to the charging station. Refer to 3.5 <i>Connecting the Boundary Wire page 27</i> .
	Boundary wire broken.	Search for the brake see 9.5 <i>Finding Breaks in the Loop Wire on page 87</i> . Replace the damaged section of the loop with a new search wire and splice using an original coupler.
	ECO mode is activated and the robotic lawnmower has attempted to start outside the charging station.	Park the robotic lawnmower in the charging station and press START and close the hatch, see 6.9 <i>Settings on page 61</i> .
	The boundary wire is laid in the wrong direction around an island.	Check that the boundary wire has been laid according to the instructions, see 3 <i>Installation on page 16</i> .
	Connection failed between the robotic lawnmower and the charging station.	Place the robotic lawnmower in the charging station and generate a new loop signal, see 6.5 <i>Security on page 47</i> .
	Disturbances from metal objects (fences, reinforcement steel) or buried cables close by.	Try moving the boundary wire.

TROUBLE SHOOTING

<i>Trapped</i>	The robotic lawnmower has got caught in something.	Free the the robotic lawnmower and rectify the reason for it becoming trapped.
	The robotic lawnmower is stuck behind a number of obstacles.	Check if there are any obstacles which make it hard for the robotic lawnmower to move on from this location.
<i>Outside working area</i>	The boundary wire connections to the charging station are crossed.	Check that the boundary wire is connected correctly.
	The boundary wire is too close to the edge of the working area.	Check that the boundary wire has been laid according to the instructions, see 3 <i>Installation on page 16</i> .
	The working area slopes too much by the boundary loop.	
	The boundary wire is laid in the wrong direction around an island.	
	Disturbances from metal objects (fences, reinforcement steel) or buried cables close by.	Try moving the boundary wire.
The robotic lawnmower finds it hard to distinguish the signal from an installation close by.	Place the robotic lawnmower in the charging station and generate a new loop signal, see 6.5 <i>Security on page 47</i> .	
<i>Wrong PIN code</i>	Wrong PIN code has been entered. Five attempts are permitted, and the keypad is then blocked for five minutes.	Enter the correct PIN code. Contact the local dealer if you forget the PIN code.
<i>Slipping</i>	The robotic lawnmower has got caught in something.	Free the robotic lawnmower and rectify the reason for the lack of drive. If it is due to wet grass, wait until the lawn has dried before using the robotic lawnmower.
	The working area includes a steep slope.	Maximum guaranteed slope is 45%. Steeper slopes should be isolated. Refer to page 20.
	The guide wire is not laid at an angle on a slope.	If the guide wire is laid on a slope, it must be laid at an angle across the slope. Refer to 3.6 <i>Installation of Guide Wire page 28</i> .
<i>Wheel motor overloaded, right</i>	The robotic lawnmower has got caught in something.	Free the robotic lawnmower and rectify the reason for the lack of drive. If it is due to wet grass, wait until the lawn has dried before using the robotic lawnmower.
<i>Wheel motor overloaded, left</i>		
<i>Charging station blocked</i>	The contact between the charging strips and contact strips may be poor and the robotic lawnmower has made a number of charging attempts.	Dock the robotic lawnmower in the charging station and check that the charging strips and contact strips make good contact.
	An object is obstructing the robotic lawnmower.	Remove the object.
<i>Stuck in charging station</i>	There is an object in the way of the robotic lawnmower, preventing it from leaving the charging station.	
<i>Upside down</i>	The robotic lawnmower is leaning too much or has turned over.	Turn the robotic lawnmower the right way up.
<i>Needs manual charging</i>	The robotic lawnmower is set to the <i>Secondary area</i> operating mode.	Place the robotic lawnmower in the charging station. This behavior is normal and no action is required.

TROUBLE SHOOTING

<i>Next start hh:mm</i>	The timer setting prevents the robotic lawnmower from operating.	Change the timer settings, see 6.3 <i>Timer on page 43</i> .
	The robotic lawnmower's clock is incorrect.	<i>Set the time. See Time and Date on page 63.</i>
<i>Empty battery</i>	The robotic lawnmower can not find the charging station.	The guide wire is broken or not connected. The battery is spent. The charging station's antenna is defective.
<i>Lift</i>	The lift sensor has been activated as the mower has got stuck.	Release the mower
<i>Impact sensor problem, front/rear</i>	The body can not move freely around the chassis.	Make sure the body can not move freely around the chassis. If the problem persists, the message must be rectified by an authorized service technician.
<i>Wheel motor problem, right/left</i>	Grass or other object has wrapped around the drive wheel.	Clean the wheels and surrounding areas.
<i>Alarm! Mower shut down</i>	Alarm has been activated as the mower is shut down.	Adapt the security level of the mower in the Security menu.
<i>Alarm! Mower stopped</i>	Alarm activated as the mower has been stopped.	
<i>Alarm! Mower lifted</i>	Alarm activated as the mower has been lifted.	
<i>Alarm! Mower tilted</i>	Alarm activated as the mower has been tilted.	
<i>Alarm! Mower outside Geofence</i>	Alarm activated as mower was moved outside the Geofence area.	
<i>Electronics problem</i>	Temporary electronic or software related problem with the mower.	Restart the mower. If the problem persists, the message must be rectified by an authorized service technician.
<i>Loop sensor problem, front/rear</i>		
<i>Charging system problem</i>		
<i>Tilt sensor problem</i>		
<i>Temporary problem</i>		
<i>Temporary battery problem</i>	Temporary battery or software related problem with the mower.	Restart the mower. Disconnect and reconnect the battery. If the problem persists, the message must be rectified by an authorized service technician.
<i>Battery problem</i>		
<i>Charging current too high</i>	Incorrect or defective power supply.	Restart the mower. If the problem persists, the message must be rectified by an authorized service technician.

TROUBLE SHOOTING

9.2 Info Messages

A number of fault messages are listed below that can be shown on the display on the robotic lawnmower. It is recommended to contact your dealer if the same message appears often. Check that the installation is performed as described in the Operator's Manual. Then contact your local dealer.

Message	Cause	Action
<i>Low battery</i>	The robotic lawnmower can not find the charging station.	Make sure the charging station and the guide wire are installed as instructed, see 3 <i>Installation on page 16</i> .
	The guide wire is broken or not connected.	Find out where the break is and rectify it.
	The battery is spent.	Contact your local dealer to test or possibly replace the battery.
	Charging station antenna is defective.	Check if the indicator lamp in the charging station flashes red. Refer to 9.3 <i>Indicator Lamp in Charging Station page 84</i> .
<i>Settings restored</i>	Confirmation that <i>Reset all user settings</i> has been carried out.	This is normal. No action required.
<i>Limited cutting height range</i>	The maximum and minimum position of the cutting height adjustment is limited.	Check that there no grass or other objects are blocking the blade disc from moving up or down.
		Carry out a cutting height calibration via the <i>Settings > Cutting height</i> menu.
		Contact your local dealer if this message appears often.
<i>Unexpected cutting height adj</i>	The cutting height adjustment is altered without a request from the robotic lawnmower.	Carry out a cutting height calibration via the <i>Settings > Cutting height</i> menu.
		Contact your local dealer if this message appears often.
<i>Guide 1 not found</i> <i>Guide 2 not found</i> <i>Guide 3 not found</i>	The guide wire is not connected to the charging station	Check that the guide wire connector is properly connected to the charging station, see 3.6 <i>Installation of Guide Wire on page 28</i> .
	Break in the guide wire	Find out where the break is. Replace the damaged section of the guide wire with a new loop wire and splice using an original coupler.
	The guide wire is not connected to the boundary loop.	Make sure the guide wire is properly connected to the boundary wire, see 3.6 <i>Installation of Guide Wire on page 28</i> . Splice with the original connector.
<i>GPS navigation problem</i>	Not applicable for Automower® 420. Problem with the GPS assisted navigation equipment.	Contact your local dealer if this message appears often.
<i>Weak GPS signal</i>	Not applicable for Automower® 420. The GPS signal is weak for the current working area. GPS assisted navigation cannot be used.	If the message appears often, turn off the GPS assisted navigation and instead use the manual settings for Lawn coverage, see <i>Installation on page 78</i> .
<i>Guide calibration failed</i>	The robotic lawnmower has failed while calibrating the guide wire.	Make sure the guide wires are installed as instructed, see 3.6 <i>Installation of Guide Wire on page 28</i> .
<i>Guide calibration accomplished</i>	The robotic lawnmower has calibrated the guide wire.	<i>No action required</i>

TROUBLE SHOOTING

Message	Cause	Action
<i>Difficult finding home</i>	The robotic lawnmower has followed the boundary wire several time without finding the charging station.	<i>Installation has not been completed correctly.</i>
		<i>Incorrect setting of corridor width on boundary wire.</i>
		<i>The lawn mower was started on a secondary area with a main area setting.</i>
<i>Temporary problem with the server.</i>	Please try again.	<i>In case of persisting problems, get in touch with your local dealer.</i>
<i>Connection problems</i>	Problem with the Automower® Connect module	Restart the mower. If the fault persists, action by and authorized service technician will be required.
<i>Connection settings restored</i>	Settings for wireless connectivity have been restored due to an error.	Check and revise settings if necessary.
<i>Weak signal</i>	Weak GPRS signal for Automower® Connect module	Make sure the mower is not upside down. If the problem persists, action by and authorized service technician will be required.
<i>SIM card requires PIN</i>	The SIM card must be unlocked.	Make sure the correct SIM PIN has been entered into the mower's menu (Network > SIM card). In case of persisting problems, get in touch with your local dealer.
<i>SIM card locked</i>	The SIM card must be replaced.	Contact the local dealer.
<i>SIM card not found</i>	Automower® Connect requires a SIM card to be inserted in the mower.	Contact your local dealer for more information.
<i>Geofence problem</i>	Your Geofence is not working due to poor (or no) communication with GPS system.	Contact the local dealer.
<i>SMS could not be sent</i>	Poor GSM coverage Max. number of SMS reached, max. 10 SMS per month can be sent to the mower. No funds left on SIM card.	<i>In case of persisting problems, get in touch with your local dealer.</i>

9.3 Indicator Lamp in Charging Station

For a fully functional installation, the indicator lamp in the charging station must emit a solid green light. If something else appears, follow the troubleshooting guide below.

There is more troubleshooting help on www.automower.com. If you still need help with troubleshooting, please contact the local dealer.

Light	Cause	Action
<i>Solid green light</i>	Good signals	No action required
<i>Green flashing light</i>	The signals are good and ECO mode is activated.	No action required. For more information on ECO mode, see 6.9 <i>Settings on page 61</i> .
<i>Blue flashing light</i>	The boundary loop is not connected to the charging station	Check that the boundary wire connector is fitted properly to the charging station. Refer to 3.5 <i>Connecting the Boundary Wire page 27</i> .
	Break in the boundary loop	Find out where the break is. Replace the damaged section of the loop with a new loop wire and splice using an original coupler.
<i>Red flashing light</i>	Interruption in the charging station's antenna	Contact the local dealer.

TROUBLE SHOOTING

<i>Solid blue light</i>	Weak signal as the boundary wire is too long. Max length is 800 m / 2 600 ft.	No steps have to be taken if the robotic lawnmower operates as expected.
		Shorten the boundary wire by reducing the working area or replacing islands with barriers the robotic lawnmower can collide with.
<i>Solid red light</i>	Defective circuit board in the charging station	Contact the local dealer.

9.4 Symptom

If your robotic lawnmower does not work as expected, follow the troubleshooting guide below.

There is a FAQ (Frequently Asked Questions) on www.automower.com which provides more detailed answers to a number of standard questions. If you still cannot find the reason for the fault, contact the local dealer.

Symptom	Cause	Action
The robotic lawnmower has difficulty docking with the charging station	The charging station is on a slope	Place the charging station on a surface that is entirely level. <i>Refer to 3.2 Installation of Charging Station page 17.</i>
	The boundary wire is not laid correctly by the charging station.	Check that the charging station has been installed according to the instructions, <i>see 3.2 Installation of Charging Station on page 17.</i>
Uneven mowing result	The robotic lawnmower works too few hours per day.	Increase the working hours, <i>see 6.3 Timer on page 43.</i>
		The Weather timer senses that the lawn has been mowed more than it actually has. Increase the intensity level in the Weather timer. Shut down the Weather timer if this does not help.
	The shape of the working area requires manual settings to be made for the robotic lawnmower to find its way to all remote areas.	Also use <i>Lawn coverage > More</i> to steer the robotic lawnmower to one or more remote areas, <i>see Installation on page 79.</i>
	Working area too large.	Try to limit the working area or extend the working time, <i>see 6.3 Timer on page 43.</i>
	Dull blades.	Replace all the blades and screws so that the rotating parts are balanced, <i>see 8.7 Blades on page 78.</i>
	Long grass in relation to the set cutting height.	Increase the cutting height and then lower successively.
	Accumulation of grass by the blade disc or around the motor shaft.	Check that the blade disc skid plate rotate easily. If not, unscrew the blade disc and remove grass and foreign objects, <i>see 8.5 Transport and Moving on page 77.</i>
The robotic lawnmower runs at the wrong time	The robotic lawnmower clock needs to be set.	Set the clock, <i>see 6.9 Settings on page 61.</i>
	The start and stop times for mowing are incorrect.	Readjust the start and stop time setting for mowing, <i>see 6.3 Timer on page 43.</i>

TROUBLE SHOOTING

The robotic lawnmower vibrates	Damaged blades lead to imbalance in the cutting system.	Inspect the blades and screws and replace them if necessary, <i>see 8.7 Blades on page 78.</i>
	Several blades in the same position lead to imbalance in the cutting system.	Check that only one blade is fitted per screw.
The robotic lawnmower runs, but the blade disc does not rotate	The robotic lawnmower follows a guide wire or boundary wire to or from the charging station.	This behavior is normal and no action is required.
	The robotic lawnmower searches for a guide wire or boundary wire and the battery charge is very low.	This behavior is normal and no action is required.
The robotic lawnmower mows for shorter periods than usual between charges	Grass or other foreign object blocks the blade disc.	Remove and clean the blade disc, <i>see 8.4 Cleaning on page 76.</i>
	The battery is spent.	Contact the local dealer.
Both the mowing and charging times are shorter than usual	The battery is spent.	Contact the local dealer.
The robotic lawnmower often moves in circles or spirals	Spiral mowing is a natural part of the robotic lawnmower's movement patten.	Adjust how often spiral mowing is carried out. This function can be deactivated if necessary. Refer to <i>6.9 Settings page 61.</i>
The robotic lawnmower turns round and stays on a small area for several minutes.	This is completely normal for Automower® 430X and 450X with GPS navigation and contributes to an even result.	No action.



TROUBLE SHOOTING

9.5 Finding Breaks in the Loop Wire

Breaks in the loop wire are usually the result of unintentional physical damage to the wire such as when gardening with a shovel. In countries with ground frost, sharp stones that move in the ground can also damage the wire. Breaks can also be due to the wire being stretched excessively during installation.

Mowing the grass too short right after the installation can damage cable insulation. Certain damage to the insulation may not cause disruptions until several weeks or months later. To avoid this, always select the maximum cutting height the first weeks after installation and then lower the height one step at a time every second week until the desired cutting height has been reached.

A defective splicing of the loop cable can also lead to disruptions first several weeks after the splice was formed. A faulty splice can, for example, be the result of the original coupler not being pressed together hard enough with a pair of pliers, or a coupler of lower quality than original coupler has been used. Please first check all known splices before further troubleshooting is done.

A wire break can be located by gradually halving the distance of the loop where the break may have occurred until there is only a very short section of the wire left.

The following method does not work if ECO mode is activated. Therefore, first ensure ECO mode has been shut down, see 6.9 *Settings on page 61*.

1. Make sure the indicator lamp in the charging station flashes blue, which indicates a break in the boundary loop. Refer to 9.3 *Indicator Lamp in Charging Station page 84*.

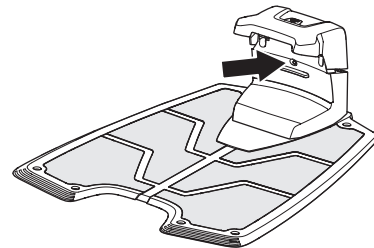

3012-1066

2. Check that the boundary wire connections to the charging station are properly connected and not damaged. Check that the indicator lamp in the charging station is still flashing blue.

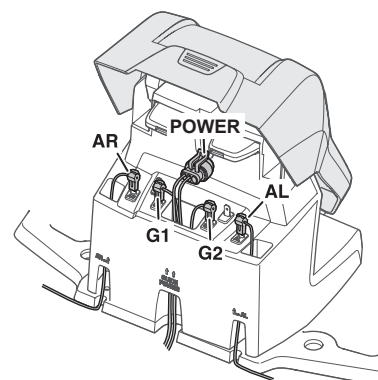

3012-1206





TROUBLE SHOOTING

3. Switch the connections between the guide wire and the boundary wire in the charging station.
 - a) Switch connection AL and G1.
If the indicator lamp is lit with a solid green light, then the break is somewhere on the boundary wire between AL and the point where the guide wire is connected to the boundary wire (thick black line in the illustration).

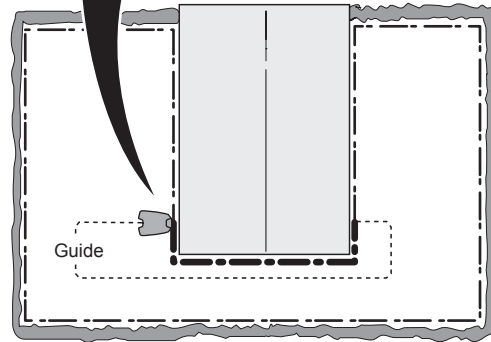
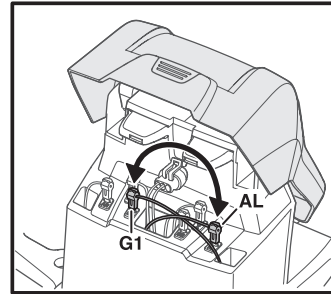

3023-043

- b) Put AL and G1 back in their original positions. Then switch AR and G1.
If the indicator lamp is lit with a solid green light, then the break is somewhere on the boundary wire between AR and the point where the guide wire is connected to the boundary wire (thick black line in the illustration).

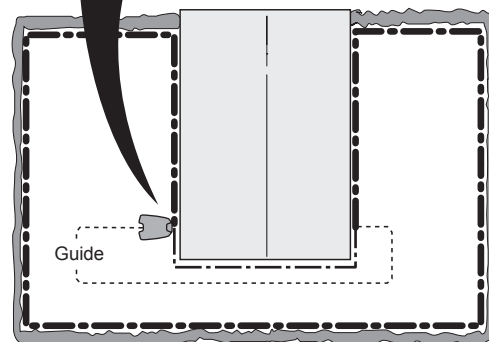
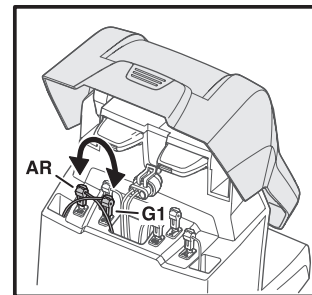

3023-042





TROUBLE SHOOTING

4. a) Assume that the indicator lamp is lit with a solid green light in test a) above. Reset all connections to their original positions. Then disconnect AR. Connect a new loop wire to AR. Connect the other end of this new loop wire somewhere at the center of the installation.

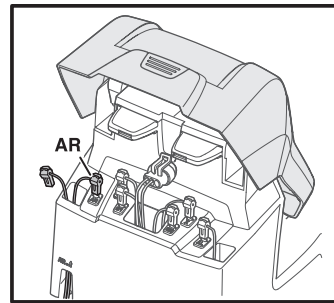

If the indicator lamp is green, then the break is somewhere in the wire between the disconnected end to the point where the new wire is connected (thick black line in the illustration below).

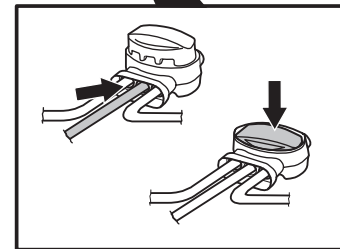
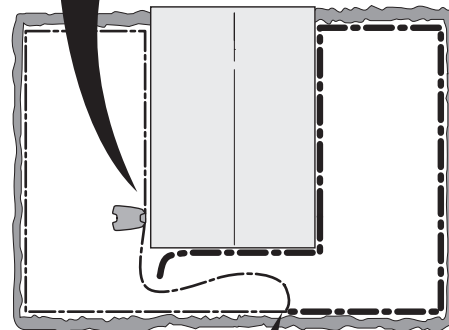

3023-044

In that case, move the connection for the new wire closer to the disconnected end (roughly at the middle of the suspected wire section) and check again if the indicator lamp is green.

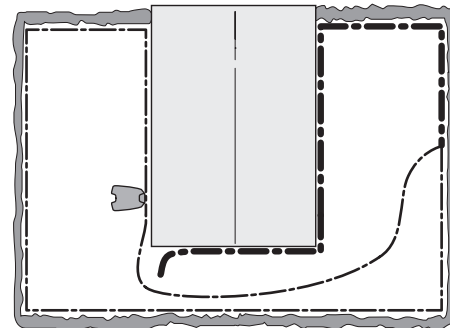

3023-029

Continue until only a very short section of the wire remains which is the difference between a flashing blue light and a solid green light.

- b) If the indicator lamp is solid green in test 3b) above, a similar test is carried out but with the new loop wire connected to AL instead.

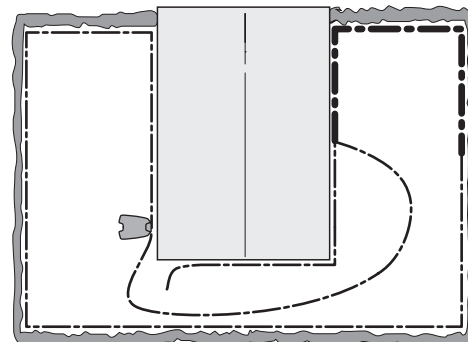

3023-030

English - 89





TROUBLE SHOOTING

5. When the break is found, the damaged section must be replaced with a new wire. The damaged section can be cut out if it is possible to shorten the boundary wire. Always use original couplers.

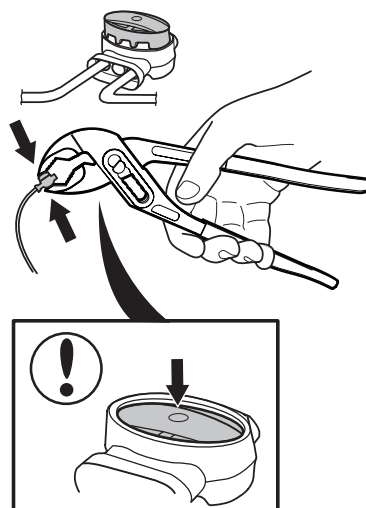

3018-055



TECHNICAL DATA

10 Technical Data

Data	Automower® 420	Automower® 430X	Automower® 450X
Dimensions			
Length	72 cm / 28.3 "	72 cm / 28.3 "	72 cm / 28.3 "
Width	56 cm / 22 "	56 cm / 22 "	56 cm / 22 "
Height	31 cm / 12.2 "	31 cm / 12.2 "	31 cm / 12.2 "
Weight	11.5 kg / 25 lbs	13.2 kg / 29 lbs	13.9 kg / 30 lbs
Electrical System			
Battery	Special Li-ion battery 18 V/3.2 Ah, Part no. 580 68 33-01	Special Li-ion battery 18 V/5.2 Ah, Part no. 588 14 64-01	Special Li-ion battery 18 V/10.4 Ah, Part no. 588 14 64-01 (2 pack)
Power supply	100–240 V/28 V DC	100–240 V/28 V DC	100–240 V/28 V DC
Length of low voltage cable	10 m / 33 ft	10 m / 33 ft	10 m / 33 ft
Mean energy consumption at maximum use	19 kWh/month in a 2 200 m ² / 0.55 acre working area	20 kWh/month in a 3 200 m ² / 0.8 acre working area	24 kWh/month in a 5 000 m ² / 1.25 acre working area
Charge Current	2.1 A DC	4.2 A DC	7 A DC
Average charging time	55 minutes	65 minutes	75 minutes
Average mowing time	105 minutes	135 minutes	260 minutes
Noise emissions in the environment measured as noise power *)			
Measured noise power level **)	56 dB (A)	56 dB (A)	58 dB (A)
Guaranteed noise power level	58 dB (A)	58 dB (A)	59 dB (A)
Noise pressure level at operators ear ***)	45 dB (A)	45 dB (A)	47 dB (A)
Cutting			
Cutting system	Three pivoted, cutting knife blades	Three pivoted, cutting knife blades	Three pivoted, cutting knife blades
Blade motor speed	2 300 rpm	2 300 rpm	2 300 rpm
Power consumption during mowing	30 W +/- 20 %	30 W +/- 20 %	35 W +/- 20 %
Cutting height	2-6 cm / 0.8-2.5 "	2-6 cm / 0.8-2.5 "	2-6 cm / 0.8-2.5 "
Cutting Width	24 cm / 9.5 "	24 cm / 9.5 "	24 cm / 9.5 "
Narrowest possible passage	60 cm / 24 "	60 cm / 24 "	60 cm / 24 "
Maximum incline of mowing area	45 %	45 %	45 %
Maximum incline of boundary wire	15 %	15 %	15 %
Maximum length of boundary wire	800 m / 2 600 ft	800 m / 2 600 ft	800 m / 2 600 ft
Maximum length of guide wire	400 m / 1 300 ft	400 m / 1 300 ft	400 m / 1 300 ft
Working capacity	2 200 m ² / 0.55 acre +/- 20 %	3 200 m ² / 0.8 acre +/- 20 %	5 000 m ² / 1.25 acre +/- 20 %
IP classification			
Robotic lawnmowers	IPX4	IPX4	IPX4
Charging Station	IPX1	IPX1	IPX1
Power supply	IPX4	IPX4	IPX4
***) uncertainties K_{WA}	2 dB (A)	2 dB (A)	1 dB (A)
***) uncertainties K_{PA}	2-4 dB (A)	2-4 dB (A)	2-4 dB (A)

*) Noise emissions in the environment measured as noise power (L_{WA}) in conformity with EC directive 2000/14/EC. The guaranteed noise power includes variation in production and variation from the test code with 1-3 dB(A).

Noise emission declarations agree with EN 50636-2-107:2015

Husqvarna AB does not guarantee full compatibility between the robotic lawnmower and other types of wireless systems such as remote controls, radio transmitters, hearing loops, underground electric animal fencing or similar.

WARRANTY TERMS

11 Warranty Terms

Husqvarna AB guarantees this product's functionality for a period of two years (from date of purchase). The warranty covers serious faults relating to materials or manufacturing faults. Within the warranty period, we will replace the product or repair it at no charge if the following terms are met:

- The robotic lawnmower and the charging station may only be used in compliance with the instructions in this Operator's Manual.
- Users or non-authorized third parties are not permitted to attempt to repair the product.

Examples of faults which are not included in the warranty:

- Damage caused by water seepage from underneath the robotic lawnmower. This damage is normally caused by laundry or irrigation systems or holes/hollows in the working area when pools of water are formed when it rains.
- Damage caused by lightning.
- Damage caused by incorrect battery storage or handling.
- Damage caused by using a battery that is not a Husqvarna original battery.
- Damage to the search wire.
- Damage that arises from the use of non-Husqvarna spares and accessories, such as blades and installation materials.

The blades are seen as disposable and are not covered by the guarantee.

If a fault occurs with your robotic lawnmower, please contact your local dealer (see Memo on page page 2) for further instructions. Please have your receipt and product serial number to hand for quicker assistance.



ENVIRONMENTAL INFO

12 Environmental Info

The symbol on the Husqvarna robotic lawnmower or its packaging indicates that this product cannot be treated as domestic waste. It should instead be left at a suitable recycling center to recycle its electronic components and batteries. The battery must also be removed from the robotic lawnmower in a safe manner.

The batteries are enclosed in the robotic lawnmower chassis. The chassis must be dismantled to access the batteries. Contact your local dealer for dismantling or see *12.1 Removal of Battery for Recycling on page 93*.

By ensuring that this product is taken care of correctly, you can help to counteract the potential negative impact on the environment and people that can otherwise result through the incorrect waste management of this product. For more detailed information about recycling this product, contact your municipality, your domestic waste service or the shop from where you purchased the product.

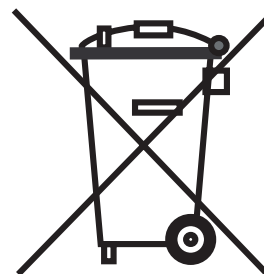

3012-689

12.1 Removal of Battery for Recycling

Follow these steps for removal of the battery from the robotic lawnmower.

RELEASE NOTES

The apparatus must be disconnected from the mains when the battery is being removed.

Disassembling the body

The body is fitted to the chassis using four quick-mounted, snap-on brackets. The charging cable fastened to the body's contact plate must be uncoupled so that the body can be completely removed from the chassis.

1. Set the main switch to position 0.
2. Clean the area around the grommet for the charging cable found at the very front under the mower.
3. Pull out the rubber grommet on the charging cable and carefully loosen the connector.
4. Loosen the body from the chassis by lifting the body one corner at a time while holding the chassis in place.

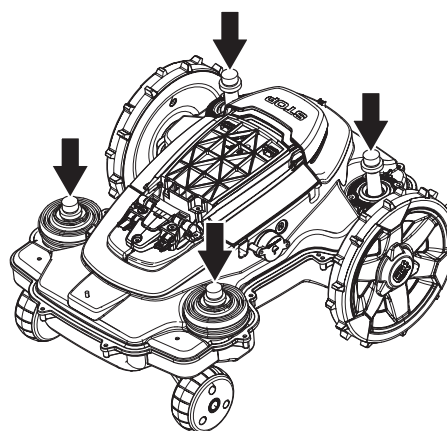

3020-111

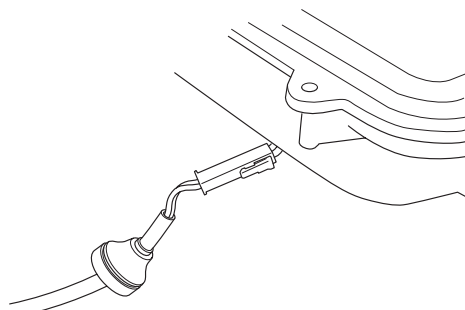

3020-109





ENVIRONMENTAL INFO

Dismantling the chassis

1. Loosen all 14 screws (Torx 20).

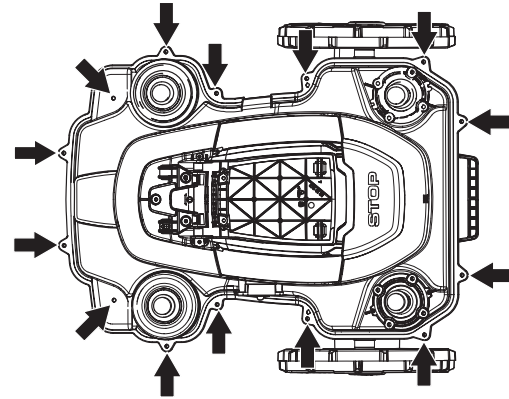

3020-110

2. Remove the guarantee seal at the point of separation between the chassis halves on the right-hand side.
3. Carefully lift the back edge of the upper section of the chassis.

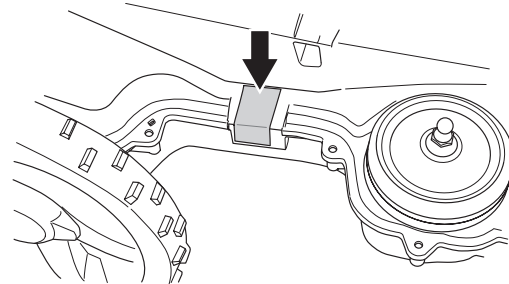

3020-112

4. Disconnect the MMI cable from the main circuit board and remove the upper section of the chassis.

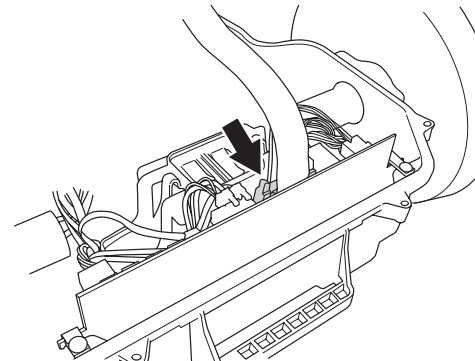

3020-113

Remove the battery

Loosen the three screws (Torx 20) holding the battery cover in place.

Disconnect the battery connection from the main circuit board.

Open the battery cover and remove the battery.

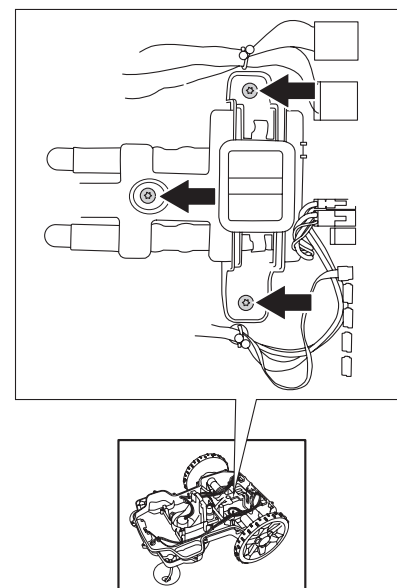

3020-128











Husqvarna[®]

ORIGINAL INSTRUCTIONS

AUTOMOWER is a trademark owned by Husqvarna AB. Copyright © 2016 HUSQVARNA. All rights reserved.

www.automower.com

115 78 66-95

