



操作手册 Operator's manual

570BTS 580BTS

请认真阅读本操作手册，确保在充分理解各项说明之后再使用机器。
Please read the operator's manual carefully and make sure you understand the instructions before using the machine.



Chinese
English

符号说明

符号

警告！如果使用不当或粗心大意，机器可能就会成为危险的工具，对操作者或他人造成严重或致命伤害。



请认真阅读本操作手册，确保在充分理解各项说明之后再使用机器。



请务必穿戴：

- 听觉保护设备
- 经检验合格的眼部保护设备
- 多尘条件下应使用通气口罩。



应在必要时佩戴手套。



吹风机将以很大的力量抛出可能反弹回来的物体。如果未使用建议的安全设备则可能会导致眼部严重受伤。



吹风机操作员必须确保 15 米范围内无任何人员或动物。当多名操作员在同一现场工作时，彼此必须保持至少 15 米的安全距离。



使您的身体部位远离发热表面。



启动注油器

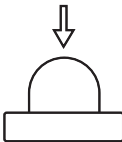

有关机器上的其他符号/标识，请参考适用于特定市场的特殊认证要求。

进行任何检查或者维护之前，请将停止开关扳到 STOP（停止）位置以关闭引擎。

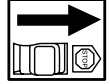

务必戴上保护手套。

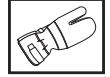

必须经常清洗。

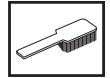

视检。



务必佩戴护目镜或面具。



加油。



阻气挺杆处于“打开位置”。



阻气挺杆处于“关闭位置”。



目录

符号说明

符号	2
目录	3
启动前应注意以下事项:	3
引言	
尊敬的客户:	4
构造图示说明	
吹风机构造图示说明	5
一般安全须知	
概述	6
安全须知	
个人防护装备	8
机器安全设备	8
机器安全设备的检查、维修和保养	9
一般工作须知	10
组装	
安装吹管和控制手柄	13
燃油处理	
燃油	14
加燃油	15
启动与停止	
启动与停止	16
维护	
概述	17
化油器	17
消音器	17
冷却系统	17
进气栅网	18
火花塞	18
空气滤清器	18
维护计划	19
技术参数	
技术参数	20
有限保修	
有限保修	21

启动前应注意以下事项:

请详细阅读操作手册。



警告！ 长期接触噪音会导致永久性听力损伤。因此，请务必佩戴检验合格的听觉保护设备。



警告！ 任何情况下，未经制造厂的许可，不得修改本机的设计。必须使用原厂零件。未经许可擅自修改，或使用未经认可的零件，可能会对操作员或其他人员造成严重的伤害或死亡。



警告！ 吹风机是一种危险工具！不小心或不正确使用会造成严重甚至致命伤害。阅读并且理解本《操作手册》的内容极其重要。

连续开发产品是 Husqvarna AB 的政策，因此拥有保留修改产品设计和外观的权利，而无需事先通知。

本机仅适用于吹扫草坪、小路、沥青道路和类似区域。

引言

尊敬的客户：

感谢您选购 Husqvarna 产品！Husqvarna 的历史可以追溯到 1689 年，当时瑞典国王查尔斯十一世下令在 Husqvarna River 的河岸上开办一家火枪生产厂。选择这一地点非常合理，这是因为当时利用 Husqvarna River 中的水力来建立水力发电厂。在 300 多年的成长过程中，Husqvarna 工厂生产出了许多不同的产品，从木炉到现代化厨房用品、缝纫机、自行车、摩托车等等。1956 年，第一台电机驱动除草机问世，随后于 1959 年链锯诞生，这就是 Husqvarna 如今所从事的领域。

如今，Husqvarna 已经成为世界上领先的园林产品生产商之一，公司极为重视产品质量。公司的商业理念为：为园林与建筑行业开发、生产与提供电机驱动产品。此外，Husqvarna 的目标是在人体工程学、使用性、安全性及环保方面居于领先地位。这就是我们为这些领域中的产品开发许多不同功能的原因所在。

我们相信，在相当长一段时间之后，您会对我们产品的质量与性能高度满意。购买我们的任意产品，您都将随时获得专业的维修和保养帮助。如果出售本机的零售商不是我们的授权经销商，应咨询离您最近的保养厂的地址。

希望我们的产品让您称心如意并与您长期相伴。请将本操作手册视为重要文档。遵照其中的内容（使用、维修、维护等），机器的使用寿命及转让时的价值都将大大提高。出售本机时，请确保将操作手册转交买家。

非常感谢您使用 Husqvarna 产品。

连续开发产品是 Husqvarna AB 的政策，因此拥有保留修改产品设计和外观的权利，而无需事先通知。

构造图示说明

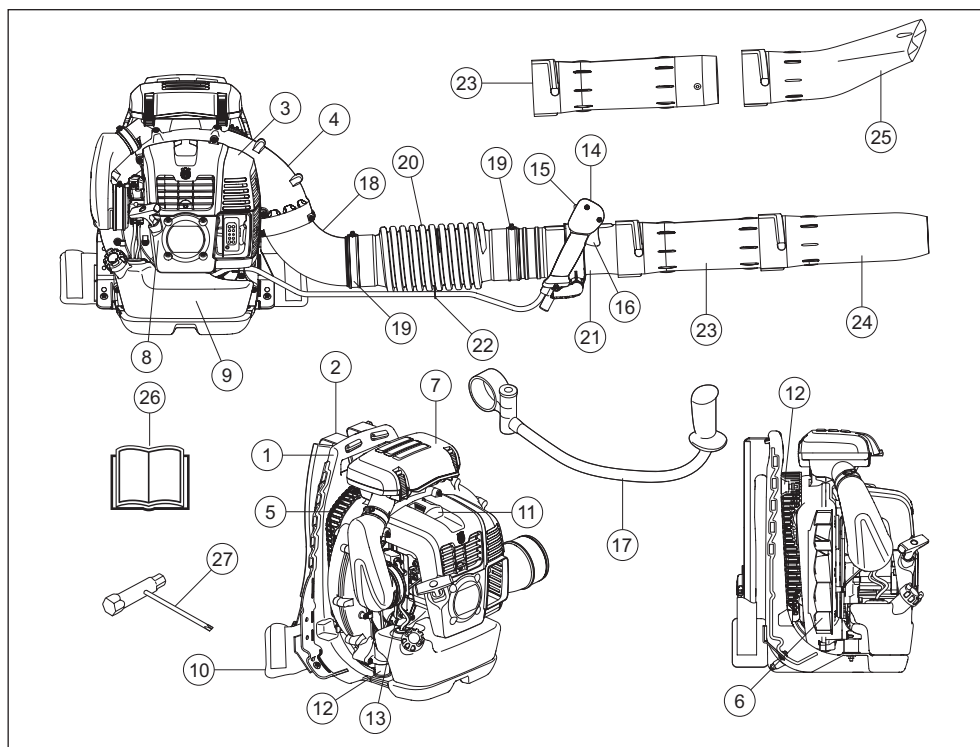

吹风机构造图示说明

- | | |
|--------------|------------------|
| 1 机架 | 15 具有油门位置设置的停止开关 |
| 2 背带 | 16 油门扳机 |
| 3 引擎盖 | 17 手柄杆 (附件) |
| 4 风扇外壳 | 18 弯管 |
| 5 进气栅网 | 19 卡箍 |
| 6 风扇 | 20 挠性软管 |
| 7 空气滤清器 | 21 控制管 |
| 8 启动器把手 | 22 卡箍 |
| 9 燃油箱 | 23 消声器联接管 |
| 10 垫 | 24 吹管 |
| 11 火花塞 | 25 扁平喷嘴 (附件) |
| 12 减振系统 | 26 操作手册 |
| 13 阻气门开关 | 27 万用扳手 |
| 14 控制手柄/操作手柄 | |

一般安全须知

概述

重要事项！

本机仅适用于吹扫草坪、小路、沥青道路和类似区域。

使用前应对机器进行全面检查。请参阅维护时间表。

感到疲劳、曾经饮酒，或曾服用影响视力、判断力或协调能力的药物时，请勿操作本机。

请使用个人防护装备。请参阅“个人防护装备”一节的说明。

绝不能使用曾对原规格进行任何改动的机器。

禁止使用有故障的机器。按照本手册中的说明进行安全检查、维护和保养。部分维护和保养措施必须由受过培训并有相应资质的专家进行。请参阅《维护》篇中的说明。

启动前必须安装好所有的盖子和防护罩。确保火花塞线帽和点火器导线未受损，以免出现电击风险。

吹风机操作员必须确保 15 米范围内无任何人员或动物。当多名操作员在同一现场工作时，彼此必须保持至少 15 米的安全距离。

严禁儿童使用机器。

在事先未确定其他人是否阅读和了解了本操作手册的内容之前，禁止其使用本机。

开始工作前，务必检查有无任何可能堵塞进气栅网的物体。

切勿拆下进气栅网。

在紧急情况下，解开腰带和胸带可离开机器并让机器向后落下。

请与当地有关当局联络，并确定您遵循相关的规定。

使您的身体部位远离发热表面。

切勿在引擎运行时触摸火花塞或点火线。



警告！ 本机在操作期间会产生电磁场。电磁场在某些情况下会干扰有源或无源医疗植入体。为了减少严重或致命性伤害风险，我们建议使用医疗植入体的人员在操作本机之前事先咨询其医生及医疗植入体制造商。

启动

- 不得在室内启动本机。吸入废气有危险。
- 观察周围并确保人员或动物不会接触吹风机。
- 将机器置于地面上，用左手将机身按在地上（注意！不要用手脚。）用右手抓住启动器把手，并稳稳地快速拉动。

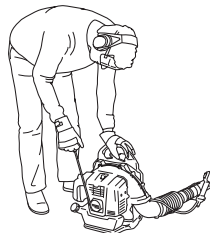

燃油安全须知

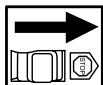

- 必须使用带防溢漏阀的油罐。
- 切勿在引擎运行时加油。加油前务必关闭引擎，并让它冷却几分钟。
- 确保加油或混合燃油（汽油和二冲程机油）时通风良好。
- 避免任何皮肤接触燃油。燃油会对皮肤产生刺激，甚至可能会导致皮肤病变。
- 启动机器之前，先将机器移到距离加油点至少 3 米外的地方。

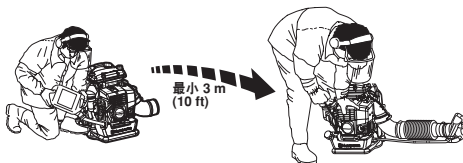

- 在下列情况下，切勿启动机器：
 - 如果机器上有溅出的燃油。先将溅出的燃油擦掉，然后让剩余的燃油蒸发掉。
 - 如果燃油溅在自己身上或衣服上，须先换掉衣服。清洗接触到燃油的身体部位。使用肥皂和水进行清洗。
 - 如果机器出现燃油泄漏。经常检查油箱盖和油管是否发生泄漏。

一般安全须知

运输及存放

- 小心储存与运输机器及燃油，以免出现漏油或油气接触火花或明火的风险，比如来自电动机械、电机、继电器/电源开关或锅炉的火花或明火。
- 存放和运输燃油时，务必使用经过批准的专用容器。
- 长时间存放本机时，必须清空燃油箱。请咨询当地加油站如何处理剩余的燃油。清空燃油箱并按下注油器，直到排空所有燃油。拆下火花塞并向油缸中加入一勺二冲程机油。翻转引擎几次，然后将火花塞放回原位。
- 在长时间存放之前，确保清洁机器并且进行全面保养。
- 运输期间将机器固定好。
- 将机器存放在干燥、凉爽、通风良好并且无尘的位置。将机器存放在儿童触及不到的位置。



警告！ 处理燃油时请小心。谨记失火、爆炸及误吸油气的危险。

调整背带



警告！ 使用机器工作时必须始终系上背带。否则将无法安全操纵并会导致您或他人受伤。

确保腰带和胸带已扣住并调整得当。

未扣住的带子有可能被卡入或吸入机器风扇中。



正确调整的背带和机器能够显著促进工作的进行。调整背带以获得最佳工作位置。



拉紧边带，以使压力均匀分布在肩膀上。



将臀带置于臀部上方，不要离腹部太远。系紧臀带，以便感觉到靠在臀部上的吹风机的重量。系紧并调整胸带以获得最佳工作位置。



安全须知

个人防护装备



警告！ 使用本机时，一定要使用经过批准的个人防护装备。个人防护装备不能避免受伤，但当意外发生时，可降低伤害程度。选择防护装备时，请向经销商查询。请认真阅读本操作手册，确保在充分理解各项说明之后再使用机器。



警告！ 戴有听觉保护设备时，请留意警告信号或呼喊声。一旦引擎停机，便取下听觉保护设备。

- 应在必要时佩戴手套。



- 佩带听觉保护设备，尽量降低噪音。

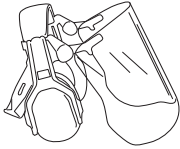

- 始终佩戴经检验合格的眼部保护设备。如果使用面罩，必须同时配戴经检验合格的护目镜。在美国，经检验合格的护目镜必须符合 ANSI Z87.1 标准；在欧盟国家/地区，必须符合 EN 166。眼睛可能会被抛出的树枝或物体击打而受到损伤。

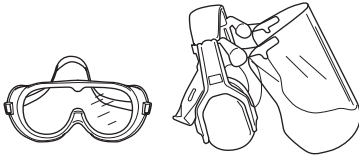

- 穿上坚固的防滑靴。



- 务必穿戴结实的长裤、靴子、手套和长袖衬衫。为了减少物体被吸入回转部件所带来的受伤风险，请勿穿着宽松衣服、佩戴围巾、珠宝等。固定住头发使其位于在肩部上方。
- 多尘条件下应使用通气口罩。

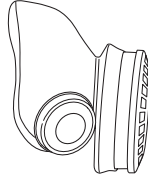

- 附近应有急救箱。

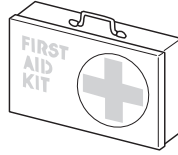

机器安全设备

本节介绍机器的安全装备及其用途，并说明如何进行检查和维修，以确保机器正常运转。请参阅《构造图示说明》部分，以找到该安全设备在机器上的正确位置。



警告！ 切勿使用安全装备存在故障的机器！务必进行本部分列出的例行检查、维修和保养。

停止开关

使用停止开关关闭引擎。

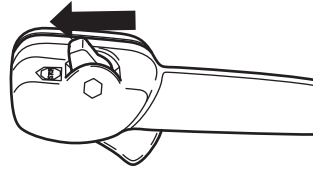

拆下点火线和火花塞，以进行检查和维护。

安全须知

减振系统

本机配备有减振系统，用于尽量减少振动，并使操作更简单。

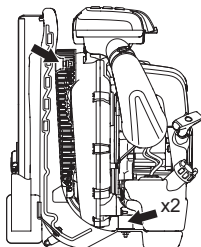

警告！ 血液循环不佳的人受到过度振动时，可能会导致循环系统或神经伤害。如果您因过度振动而引起以下症状，请自行就医。例如：麻痹、感觉麻木、发痒、刺痛、痛楚、体力缺乏、肤色或身体状况发生变化。这些症状通常出现在手指、双手或手腕上。低温情况下，这种危险会增加。

消音器

消音器设计用于最大程度地降低噪音并将引擎的废气导离操作人员。

气候温暖干燥的国家很容易发生火灾。因此，我们配备了消音器，消音器内部装有火花挡网。

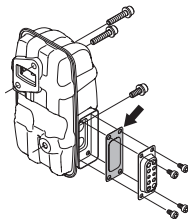

对于消音器，一定要按照说明进行检查、维修及保养。请参阅《如何检查、维修和保养机器的安全装备》篇的说明。



警告！

切记：引擎废气中含有一氧化碳，会导致一氧化碳中毒。因此，不应在室内或通风较差的任何地方启动或运行本机器。

引擎的废气很热，并可能带有火花，从而引发火灾。切勿在室内或易燃材料附近操作本机！



警告！ 消音器内含可致癌的化学物质。消音器出现故障时，务必避免接触这些物质。

机器安全设备的检查、维修和保养



警告！ 本机的保养和维修必须经过专门培训。对于本机的安全设备来说尤其如此。如果在检修过程中出现下述的故障，应与保养厂联络。如果您购买我们的产品，我们承诺提供专业的修理和保养。如果出售本机的零售商不是保养商，应向他咨询离您最近的保养厂的地址。

停止开关

- 启动引擎，确保引擎在停止开关移到停止位置时停下来。

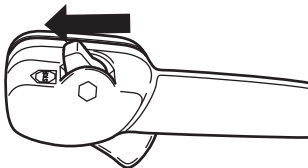

安全须知

减振系统

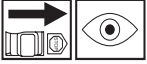

- 定期检查减振装置是否有裂痕和变形。如果有损坏，请更换。

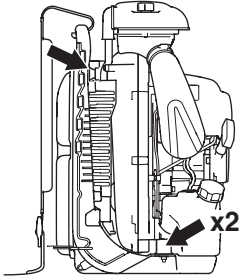

- 检查确保减震垫无损坏且安装牢固。

消音器



- 切勿使用消音器出现故障的机器。



- 定期检查消音器是否牢固安装在机器上。

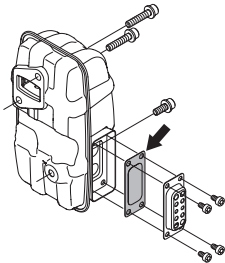

- 您的机器上的消音器配有火花挡网，必须定期清洁。请参阅《维护》章节中的《消音器》篇。挡网堵塞会导致引擎过热，并可能造成严重损坏。切勿使用火花挡网发生故障的消音器。



警告！ 不得使用安全设备存在故障的机器。机器的安全设备必须按照本节说明进行检查和维护。如果您的机器未通过这些检查中的任何一项，请联系您的保养厂对其进行维修。

空气滤清器

切勿使用没有空气滤清器或滤清元件损坏或变形的吹风机，因为未经过滤的含尘空气会迅速损坏引擎。

一般工作须知

重要事项！ 本节介绍使用吹风机工作时的基本安全守则。当您遇到任何情况，不知如何继续时，请咨询专家。与您的经销商或保养厂联系。避免任何超出您能力范围的使用。

考虑到周围的居民，应避免在不适当的时间使用机器，如夜间或清晨。限制同时使用的设备装置数量以降低噪音。通读并遵循简单指示，以便尽可能减少对周边的干扰。

- 使用吹风机时尽可能使用最小的油门。很少需要使用全开油门，很多工作流程均可以半油门完成。较低的油门意味着较低的噪音和较少的灰尘，此外还更易于控制收集/移动的垃圾。
- 使用耙子或刷子清除粘在地面上的垃圾。
- 使吹风机的开口尽可能靠近地面。利用吹管的整个长度来使气流贴近地面。
- 之后进行清理。



警告！ 注意周围。如果有人靠近您的工作区域，应将油门控制设置到最低油门，直到该人处于安全距离为止。吹风机应远离人员、动物、游乐场、敞开的窗户、汽车等。

安全须知

基本安全守则



- 未经授权人员或动物不得进入 15 米范围内的工作区域。
- 加油前请先让引擎冷却。
- 使您的身体部位远离发热表面。
- 如果机器着火或出现其他需要您离开机器的紧急情况，应解开背带并让机器向后落下。
- 强大的气流会使物体以可以弹回的速度移动并导致严重的眼部受伤。

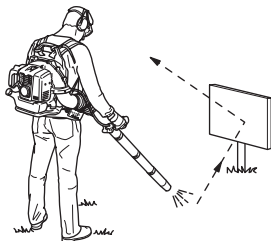

- 请勿将空气喷嘴正对人或动物。
- 安装或拆卸附件或其他零件前应停止引擎。
- 避免在不良的天气情况下使用本机，例如浓雾、大雨、强风或是严寒等。在天气不良的情况下工作容易让人疲倦，更可能造成危险状况，例如容易滑倒的地面。
- 确保您可以安全地移动与站立。检查您的周围区域是否存在障碍物（树根、岩石、树枝、沟渠等），以免您突然移动。在倾斜地面上工作时，要特别小心。



- 切勿在引擎运转的情况下放下机器，除非是放在您可以清楚看到的位置。
- 引擎废气中含有一氧化碳，会导致一氧化碳中毒。因此，不应在室内或通风较差的任何地方启动或运行本机。
- 在梯子或脚手架上或在高处（如屋顶）禁止使用吹风机。否则将会导致严重受伤。



- 小心！如果发生事故时无法求救，请勿使用本机。

安全须知

基本工作技巧



警告！注意抛掷物。始终佩戴眼部保护设备。石头、垃圾等会抛入眼中，导致失明或严重伤害。未经授权的人员不得靠近。儿童、动物、围观者和助手应位于 15 米外的安全区域中。如果有人进入则应立即关闭机器。



警告！如果引擎盖上的排气出口被墙壁和/或其他障碍物遮住，请勿操作吹风机，否则机器会受到损坏。在操作过程中，请确保与障碍物至少相距 50 cm。



警告！在清洁之前务必停止引擎运行。

- 本吹风机为背包式，可在运行时使用肩带携带。右手握住管上的手柄进行操作和控制。
- 空气喷嘴的速度可通过油门进行调节。选择最适于各自任务的速度。

使用“停止开关”可以设置油门位置，这样就不需要在使用吹风机时一直将手指按在油门上。当控制手柄保持在完全向后位置时，可获得全开油门。

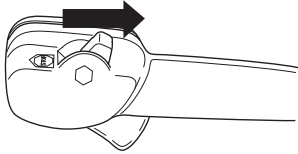

- 检查确保空气吸入口未被树叶或垃圾等堵塞。空气吸入口堵塞会降低机器的吹风能力，并使引擎的工作温度升高，从而导致引擎故障。停止引擎并清除物体。

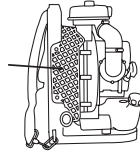

- 注意风向。利用风力更易于工作。
- 使用吹风机移动大型堆积物非常耗时，并产生不必要的噪音。
- 请保持平衡并找到牢固的立足处。
- 完成工作时机器应垂直存放。

组装

安装吹管和控制手柄

- 将吹风机和控制管与挠性软管相连。将挠性软管的两端固定到位。使用随附的紧固件。

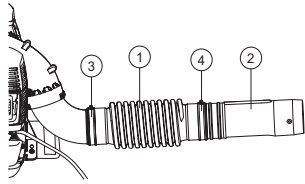

- 1 挠性软管
- 2 控制管
- 3 卡箍
- 4 卡箍

注意！

稍微润滑管以便安装。

- 将手柄架固定在控制管上，并拧紧手柄架上的旋钮。请确保将手柄架与控制管的凸起处对齐。

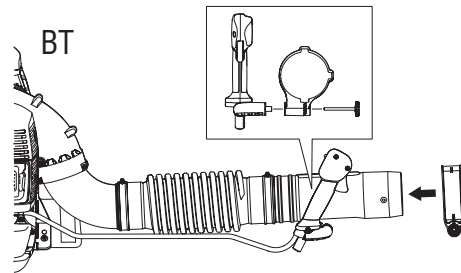

- 调整位置和角度，以获得舒适的工作位置，然后拧紧。

- 使用卡箍将缆线固定在挠性软管上。

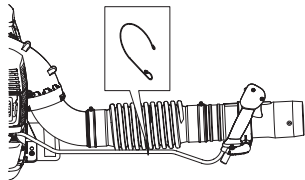

- 连接直管和管端。将管对在一起并转动使其锁紧。

附件

手柄杆

拆卸联接管。从手柄架上拆下旋钮，并将手柄架推到手柄架管上。装配旋钮并拧紧。

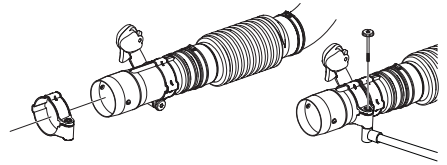

装配联接管。

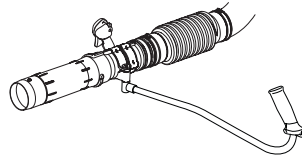

- 如果需要更高的风速，应将圆形吹管更换成扁平喷嘴。

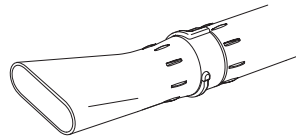

燃油处理

燃油

小心！本机配有一个二冲程引擎，必须始终使用汽油与二冲程机油混合的燃油运行。注意准确测定要混合的油量，以确保正确混合。混合少量燃油时，即使小误差也会严重影响混合比。



警告！ 确保在空气流通的地方处理燃油。

汽油

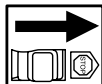

小心！务必使用优质汽油/机油混合物（辛烷值至少为 90）。



- 建议采用的最低辛烷值为 90。如果使用辛烷值低于 90 的汽油，会引起爆震。这会导致引擎过热，令引擎严重受损。
- 连续高转速作业时，建议提高辛烷值。请使用高品质无铅汽油。

可使用乙醇混合燃油 E10（乙醇混合浓度最高 10%）。使用高于 E10 的乙醇混合燃油将产生贫油运行条件，从而对引擎造成损害。

二冲程机油

- 最好使用 HUSQVARNA 为二冲程引擎特别开发的二冲程机油。混合比 1:50 (2%)。
- 如果无法取得 HUSQVARNA 的二冲程机油，请选用其它气冷式引擎专用的高品质二冲程机油。选择机油时，请与您的代理商联络。混合比 1:33 (3%)。
- 千万不可使用水冷式舷外引擎专用的二冲程机油，即所谓的舷外机油。
- 千万不可使用四冲程引擎专用的机油。

汽油, 公升	二冲程机油, 公升	
	2% (1:50)	3% (1:33)
5	0.10	0.15
10	0.20	0.30
15	0.30	0.45
20	0.40	0.60

混合

- 请在干净的燃油专用容器内混合汽油与机油。
- 务必首先加入一半汽油。然后加入全部的机油。混合（摇匀）混合液。最后再加入另一半汽油。
- 加入机器的燃油箱之前，务必充分混合（摇匀）燃油混合液。



- 一次混合的油量不要超过一个月的用量。
- 如果机器一段时间不使用，应倒光油箱内的油，并清理干净。

加燃油



警告！ 采取下列注意事项可以减少火患的发生：

务必在通风良好的区域加油。千万不要在室内给机器加油。

不要吸烟或者把热烫的物体放在燃油旁边。

加油前先关掉引擎。

加油前务必关闭引擎，并让它冷却几分钟。

加油时，请慢慢打开油箱盖，以便缓慢释放过高的压力。

加油之后小心拧紧燃油箱盖。

如果将燃油溅在机器上。先将溅出的燃油擦掉，然后让剩余的燃油蒸发掉。

务必将机器移离加油区和加油站之后才可启动。

- 启动机器之前，先将机器移到距离加油点至少 3 米外的地方。

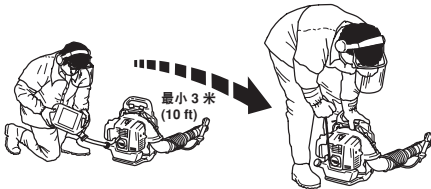

- 将油箱盖四周清理干净。油箱上的污物会导致运行故障。
- 先将油罐摇匀，充分混合燃油后，再加入油箱。
- 每次使用前应检查油位，并留出燃油膨胀的空间，因为引擎和太阳的热量可能会导致燃油膨胀并溢出。

启动与停止

启动与停止



警告！ 务必将机器移离加油区和加油站之后才可启动。将机器停放在平整表面上。

确定没有非工作人员在现场。否则会造成严重的人身伤害。安全距离为 15 米。

机器仅在按照设计配备全套部件的情况下启动。如果在未安装所有防护罩的情况下启动机器，则会导致人身伤害。

冷引擎

点火装置： 将停止开关设置到开始位置。开度大约为三分之一。

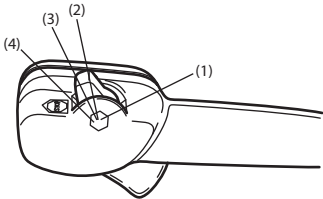

- 1 全开油门
- 2 开度大约为三分之一。
- 3 空转速度
- 4 停止开关

禁止将停止开关设置在全开油门位置。

阻气门： 将风门设在阻风位置。

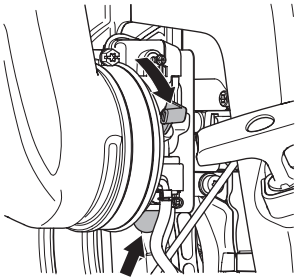

启动注油器： 反复挤压注油泵直至燃油开始注入球囊。不必将球囊装满。

暖引擎

步骤与启动冷引擎相同，但是无需将阻气门控制设定在阻气门位置上。

启动

用左手将机器按在地上（小心！不要用脚！）用右手抓住启动器把手，慢慢地向外拉启动绳，直到感觉到有阻力（止轮具抓紧），然后快速用力地拉。

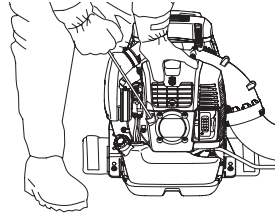

千万不可将启动器拉绳绕在手上。

拉动启动器把手，直到引擎启动。引擎启动后，将阻气门控制返回到运行位置。

小心！ 不要将启动器的拉绳拉到底，也不要完全拉出的位置放开启动器把手。这样做会损坏机器。

注意！

引擎启动后将立即释放空气，即便是在空转速度运行时。由于阻气过多，尝试几次后引擎无法启动，则打开阻气门并重复拉动启动绳。

使用油门控制设置所需的引擎速度。

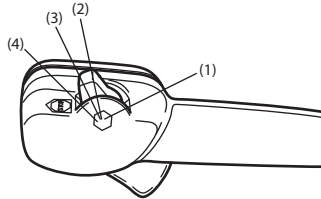

- 1 全开油门
- 2 开度大约为三分之一。
- 3 空转速度
- 4 停止开关

停止

将停止开关拨至停止位置，关闭引擎。

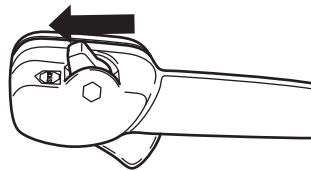

维护

概述

拆下点火线和火花塞，以进行检查和维护。使您的身体部位远离发热表面。

化油器

调节空转速度

进行调节之前，确保空气滤清器清洁并已装好空气滤清器外壳。

出厂空转速度设为 2000 rpm。如果必须调节空转速度，则使用化油器上边缘的调整螺钉。

消音器

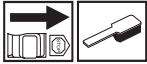

消音器的设计是用于降低噪音，同时将引擎的废气导离操作者。引擎的废气很热烫，有时会激发火花，如果溅向干燥易燃的材料，可能会引起火灾。

一些消音器配有专门的火花挡网。火花挡网应当每月清洁一次。最好用钢丝刷进行清洁。

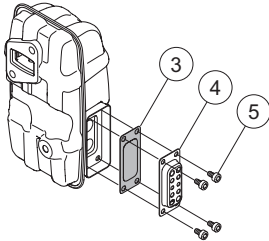

火花挡网的拆卸流程如下：

- 拆下排气管（4、5）。
- 拆下火花消除器（3）。
- 拉出火花挡网并用钢丝刷进行清洁。如果火花挡网故障则应进行更换。

小心！切勿使用消音器发生故障的机器。定期检查消音器是否完好无损且妥善固定。（1）、（2）拧紧螺丝。8-10 Nm

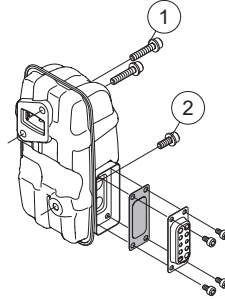

检查火花消除器和排气管是否正确拧紧到位（5）。紧固至 2-3 Nm。



警告！消音器在使用过程中会变得非常热，并且在停止后仍保持一段时间。怠速时同样如此。接触会灼伤皮肤。注意火灾危险！

冷却系统

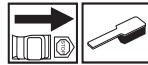

为了尽量保持较低的操作温度，本机器配备了冷却系统。

冷却系统由以下部分组成：

- 气缸上的散热片。
- 进气栅网

每周一次用刷子清洗冷却系统，在恶劣的环境下更应常清洗。脏污或堵塞的冷却系统会引起引擎过热，导致气缸及活塞损坏。检查确认喷嘴未被堵塞。

维护

进气栅网

检查确保各侧（包括外侧）的空气吸入口未被树叶或垃圾等堵塞。空气吸入口堵塞会降低机器的吹风能力，并使引擎的工作温度升高，从而导致引擎故障。停止引擎并清除物体。

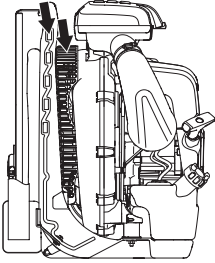

警告！ 如果栅网未安装到位，切勿使用吹风机。使用前，检查栅网是否安装到位且未损坏。

火花塞



火花塞的状况会受下列的因素影响：

- 化油器调节不正确。
- 燃油混合不正确（机油太多或种类不对）。
- 空气滤清器变脏。

这些因素会导致异物堆积在火花塞电极上，从而造成操作问题及启动困难。

清洁火花塞外部。拔下火花塞，然后检查跳火间距。将跳火间距调至 0.6 - 0.7 mm 或更换火花塞。检查并确定火花塞安装有抑制器。

0.6 - 0.7 mm

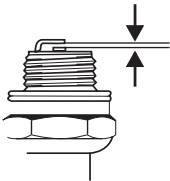

小心！务必使用推荐的火花塞类型！不适合的火花塞会损坏活塞/气缸。

空气滤清器

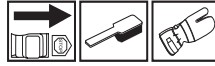

必须定期清洁空气滤清器，以清除泥土和灰尘，避免发生下列情况：

- 化油器故障。
- 启动问题。
- 引擎功率损耗。
- 引擎零件发生不必要磨损。
- 过度耗油。

每 40 小时清洁一次滤清器，或者如果在灰尘异常多的环境下，则要增加清洁次数。

避免接触消音器、气缸等的高温表面，否则会烫伤皮肤。

清洁空气滤清器

- 拧松空气滤清器外壳的四个紧固件，拆下滤清器。在温肥皂水中将预滤器清洗干净。

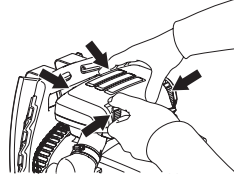

清洁空气滤清器。清洗滤清器时不要在硬表面上敲打它。这样会损坏滤清器。如果纸质滤清器仍较脏，应更换成新滤清器。

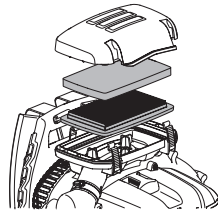

注意！

切勿使用油性溶剂清洁空气滤清器。

滤清器经过长期使用之后，无法彻底清洁。因此，所有的空气滤清器都应定期更换新的。**损坏的空气滤清器一定要换新。**

- 重新安装空气滤清器和空气滤清器外壳。

维护

维护计划

以下是部分一般维修说明。欲知更多详情如需进一步的资料，请与保养厂联络。

维护	日常维护	每周维护	每月维护
清洁机器的外部。	X		
检查油门控制是否安全工作。	X		
检查停止开关能否正常操作。	X		
清洁空气滤清器。必要时换新。	X		
检查螺母和螺丝是否上紧。	X		
检查引擎、油箱与燃油管是否漏油。	X		
检查燃油滤清器上是否有污物，油管是否有裂痕或其它破损现象。必要时换新。	X		
清洁或更换消音器上的火花挡网（仅适用于未安装催化转换器的消音器）。	X		
检查确保进气栅网的各侧未被堵塞。	X		
检查启动器及启动器绳索。		X	
检查确认防振元件未损坏。		X	
清洁火花塞外部。拔下火花塞，然后检查跳火间距。将跳火间距调至 0.6 - 0.7 mm 或更换火花塞。检查并确定火花塞安装有抑制器。		X	
清洁机器的冷却系统。		X	
清洁化油器外部以及其周围区域。		X	
检查所有的电缆及接头。			X
更换火花塞。检查并确定火花塞安装有抑制器。			X
检查并清洁消音器上的火花挡网（仅适用于安装催化转换器的消音器）。			X
清洁燃油箱。			X

技术参数

技术参数

技术参数	570BTS	580BTS
引擎		
气缸排量 (cm ³)	65.6	75.6
空转速度 (rpm)	2000	2000
最大引擎输出, 按照 ISO 8893, 单位为 kW/rpm		
催化转换器消音器	无	否
调速点火系统	是	是
点火系统		
火花塞	NGK CMR7H	NGK CMR7H
跳火间距 (mm)	0.6-0.7	0.6-0.7
燃油和润滑系统		
燃油箱容量 (L)	2.2	2.6
重量		
空重, 公斤 (磅)	11.2	11.8
噪声排放		
(参阅注释 1)		
声功率级, 测量值 dB(A)	110	111
声能级, 保证值 L _{WA} dB (A)	110	112
噪声级		
(参阅注释 2)		
操作人员耳旁的等效声压级, 根据 EN15503 测得, 单位为 dB(A)	99	100
振动程度		
(参阅注释 3)		
手柄的等效振级 (a _{hw,eq}), 根据 EN15503 测得, 单位为 m/s ²	1.8	1.6
风扇性能		
标准喷嘴的最大气流速度, m/s:	106	92
扁平喷嘴的最大气流速度, m/s:	91	93
标准喷嘴的气流量, m ³ /min	22	26
扁平喷嘴的气流量, m ³ /min:	24	25

注释 1: 环境噪声释放按照欧盟指令 2000/14/EC 规定的声能 (L_{WA}) 进行测量。报告给出的机器声功率级是按照原装切割锯片的最高噪声级别测量得出的。保证声功率与测定声功率之间存在差异, 在于保证声功率按照 2000/14/EC 指令的要求还包含了测量结果中的离差以及相同型号不同机器之间的偏差。

注释 2: 等效声压级值按照持续时间分别为 1/7 (怠速) 和 6/7 (运行) 的工作循环计算得出。本机的等效声压级的报告数据具有一个 1 dB(A) 的典型统计离差 (标准偏差)。

注释 3: 等效振级值按照持续时间分别为 1/7 (怠速) 和 6/7 (运行) 的工作循环计算得出。等效振级的报告数据中具有一个 1 m/s² 的典型统计离差 (标准偏差)。

有限保修

有限保修

如果在试用保修期内的正常工作情况下产品出现任何故障，则将由 Husqvarna 授权经销商免费更换或修理故障的零件。

保修期：最终用户购买后六 (6) 个月，以生产月份起 12 个月为准。（如果用于租赁目的则为 30 天）。

买方应承担装运往返 Husqvarna 经销商的运输费用。

如果在 Husqvarna 经销商处执行诊断工作，买方不对应确定保修零件存在缺陷的诊断工作承担费用。

买方或所有者负责执行所有者/操作手册中制造商规定的所需维护工作。

对于必要维护计划更换、仅按计划定期检查维修是否有缺陷或“在必要时更换”的任何保修零件在保修期内享有保修。对于必要维护计划内更换的保修零件应在该零件的第一次计划更换时间点之前享有保修。

任何在非保修维护或维修中使用的具有同等性能和耐久性的更换零件，公司将同样承担保修责任。

保修不适用于因以下原因导致装置损坏的情况：忽视所有者/操作手册中所列的有关装置使用和保护的说明、事故处理不当、改装、滥用、润滑不当、使用公司规定以外的任何零件或附件、或其他超出公司控制范围的原因。

此保修不适用于因忽视《所有者/操作手册》中所列有关正确使用和维护装置说明而导致的装置损坏情况，包括搬运不当、改装、滥用、润滑不当、使用公司指定范围以外的部件或附件，或其他超出公司控制范围的原因。

此保修不适用于部件因正常磨损或外观发生无变化而需更换的情况。

没有任何明示性担保。

任何暗示性保修仅限于有限保修期间。另外，此有限保修将代替所有其他明示或暗示性保修，包括用于特殊用途的耐用性保证以及本产品耐用性的暗示性担保。

任何及所有保修不包括意外或间接损坏责任。

如需了解更多信息，请致电最近的服务中心，或访问 Husqvarna 网站 <http://www.husqvarna.com>

KEY TO SYMBOLS

Symbols

WARNING! The machine can be a dangerous tool if used incorrectly or carelessly, which can cause serious or fatal injury to the operator or others.



Please read the operator's manual carefully and make sure you understand the instructions before using the machine.



Always wear:

- Hearing protection
- Approved eye protection



A breathing mask should be used when there is a risk of dust.

Gloves should be worn when necessary.



The blower can forcibly throw objects that can bounce back. This can result in serious eye injuries if the recommended safety equipment is not used.



The blower operator must ensure that no people or animals come closer than 15 metres.



When several operators are working at the same site a safety distance of at least 15 metres must be in effect.

Keep all parts of your body away from hot surfaces.



Air purge

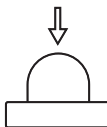

Other symbols/decals on the machine refer to special certification requirements for certain markets.

Switch off the engine by moving the stop switch to the STOP position before carrying out any checks or maintenance.



Always wear protective gloves.



Regular cleaning is required.



Visual check.



Protective goggles or a visor must be worn.



Refuelling.



Choke lever in "open position".



Choke lever in "closed position".



CONTENTS

Contents

KEY TO SYMBOLS

Symbols 22

CONTENTS

Contents 23

Note the following before starting: 23

INTRODUCTION

Dear Customer, 24

WHAT IS WHAT?

What is what on the blower? 25

GENERAL SAFETY PRECAUTIONS

General 26

SAFETY INSTRUCTIONS

Personal protective equipment 28

Machine's safety equipment 28

Checking, maintaining and servicing the machine's safety equipment 29

General working instructions 30

ASSEMBLY

Assembling the blow pipe and control handle 33

FUEL HANDLING

Fuel 34

Fueling 35

STARTING AND STOPPING

Starting and stopping 36

MAINTENANCE

General 37

Carburettor 37

Muffler 37

Cooling system 37

Air intake screen 38

Spark plug 38

Air filter 38

Maintenance schedule 39

TECHNICAL DATA

Technical data 40

EC Declaration of Conformity 41

LIMITED WARRANTY

Limited warranty 42

Note the following before starting:

Please read the operator's manual carefully.



WARNING! Long-term exposure to noise can result in permanent hearing impairment. So always use approved hearing protection.



WARNING! Under no circumstances may the design of the machine be modified without the permission of the manufacturer. Always use original accessories. Non-authorized modifications and/or accessories can result in serious personal injury or the death of the operator or others.



WARNING! A blower is a dangerous tool if used carelessly or incorrectly and can cause serious, even fatal injuries. It is extremely important that you read and understand the contents of this Operator's manual.

Husqvarna AB has a policy of continuous product development and therefore reserves the right to modify the design and appearance of products without prior notice.

The machine is only designed for blowing lawns, pathways, asphalt roads and the like.

INTRODUCTION

Dear Customer,

Congratulations on your choice to buy a Husqvarna product! Husqvarna is based on a tradition that dates back to 1689, when the Swedish King Karl XI ordered the construction of a factory on the banks of the Husqvarna River, for production of muskets. The location was logical, since water power was harnessed from the Husqvarna River to create the water-powered plant. During the more than 300 years in existence, the Husqvarna factory has produced a lot of different products, from wood stoves to modern kitchen appliances, sewing machines, bicycles, motorcycles etc. In 1956, the first motor driven lawn mowers appeared, followed by chain saws in 1959, and it is within this area Husqvarna is working today.

Today Husqvarna is one of the leading manufacturers in the world of forest and garden products, with quality as our highest priority. The business concept is to develop, manufacture and market motor-driven products for forestry and gardening, as well as for the building and construction industry. Husqvarna's aim is also to be at the front edge for ergonomics, usability, security and environmental protection. That is the reason why we have developed many different features to add to our products within these areas.

We are convinced that you will appreciate with great satisfaction the quality and performance of our product for a very long time to come. The purchase of one of our products gives you access to professional help with repairs and service whenever this may be necessary. If the retailer who sells your machine is not one of our authorized dealers, ask for the address of your nearest service workshop.

It is our wish that you will be satisfied with your product and that it will be your companion for a long time. Think of this operator's manual as a valuable document. By following its content (usage, service, maintenance, etc), the life span and the second-hand value of the machine can be extended. If you sell this machine, make sure that the operator's manual is passed on to the buyer.

Thank you for using a Husqvarna product.

Husqvarna AB has a policy of continuous product development and therefore reserves the right to modify the design and appearance of products without prior notice.

WHAT IS WHAT?

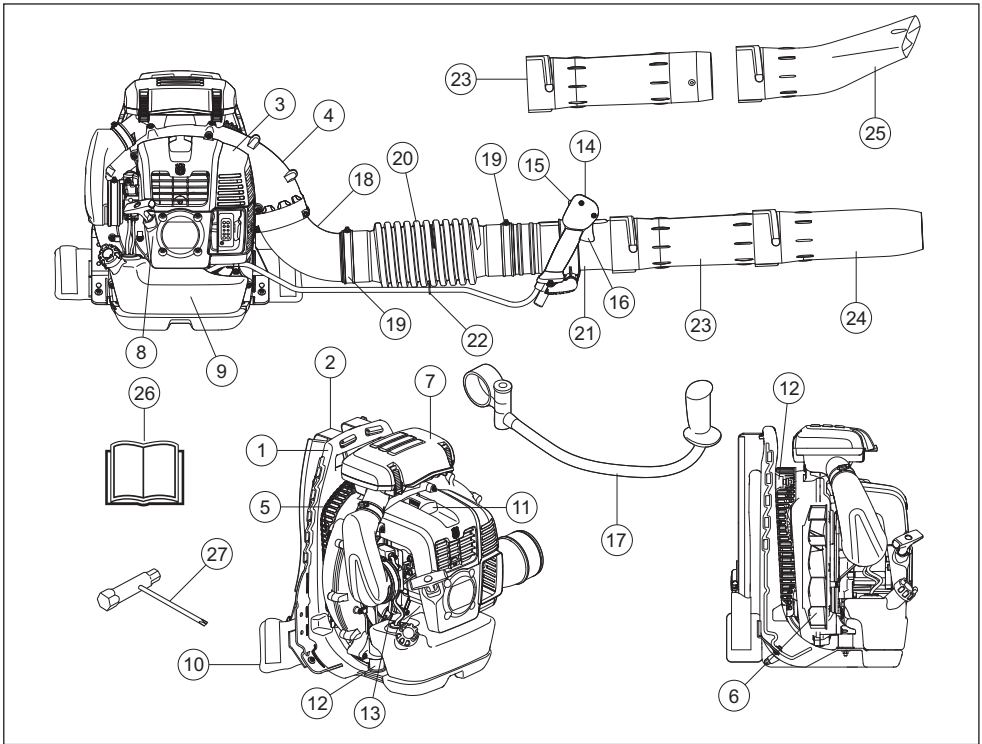

What is what on the blower?

- | | | | |
|----|---------------------------------|----|--|
| 1 | Frame | 15 | Stop switch with throttle position setting |
| 2 | Harness | 16 | Throttle trigger |
| 3 | Engine cover | 17 | Handlebar (Accessory) |
| 4 | Fan shell | 18 | Elbow |
| 5 | Air intake screen | 19 | Clamp |
| 6 | Fan | 20 | Flexible hose |
| 7 | Air cleaner | 21 | Control pipe |
| 8 | Starter handle | 22 | Clamp |
| 9 | Fuel tank | 23 | Intermediate pipe |
| 10 | Pad | 24 | Blower nozzle |
| 11 | Spark plug | 25 | Flat nozzle (Accessory) |
| 12 | Vibration damping system | 26 | Operator's manual |
| 13 | Choke control | 27 | Combination spanner |
| 14 | Control handle/Operating handle | | |

GENERAL SAFETY PRECAUTIONS

General

IMPORTANT!

The machine is only designed for blowing lawns, pathways, asphalt roads and the like.

Carry out an overall inspection of the machine before use. See the maintenance schedule.

Never use the machine if you are tired, if you have drunk alcohol, or if you are taking medication that could affect your vision, your judgement or your co-ordination.

Wear personal protective equipment. See instructions under the "Personal protective equipment" heading.

Never use a machine that has been modified in any way from its original specification.

Never use a machine that is faulty. Carry out the safety checks, maintenance and service instructions described in this manual. Some maintenance and service measures must be carried out by trained and qualified specialists. See instructions under the Maintenance heading.

All covers and guards must be fitted before starting. Ensure that the spark plug cap and ignition lead are undamaged to avoid the risk of electric shock.

The blow operator must ensure that no people or animals come closer than 15 metres. When several operators are working at the same site a safety distance of at least 15 metres must be in effect.

Never allow children to use the machine.

Never allow anyone else to use the machine without first ensuring that they have read and understood the contents of the operator's manual.

Always check for any objects that may block the air intake screen before beginning work.

Never remove the air intake screen.

In case of emergency, release yourself from the machine by opening the waist and chest belt and let the machine fall backwards.

Always contact local authorities and make sure you are following applicable directives.

Keep all parts of your body away from hot surfaces.

Never touch the spark plug or ignition cable while the engine is running.



WARNING! This machine produces an electromagnetic field during operation. This field may under some circumstances interfere with active or passive medical implants. To reduce the risk of serious or fatal injury, we recommend persons with medical implants to consult their physician and the medical implant manufacturer before operating this machine.

Starting

- Never start the machine indoors. Exhaust fumes can be dangerous if inhaled.
- Observe the surroundings and ensure that no people or animals can come into contact with the blower.
- Place the machine on the ground, press the machine body against the ground with your left hand (NOTE! Not your foot). Now grasp the starter handle with your right hand and then pull quickly and firmly.



Fuel safety



- Always use a fuel container with an anti-spill valve.
- Never refuel the machine while the engine is running. Always stop the engine and let it cool for a few minutes before refuelling.
- Make sure there is plenty of ventilation when refuelling or mixing fuel (petrol and 2-stroke oil).
- Avoid all skin contact with fuel. Fuel is a skin irritant and may even cause skin changes.
- Move the machine at least 3 m from the refuelling point before starting it.

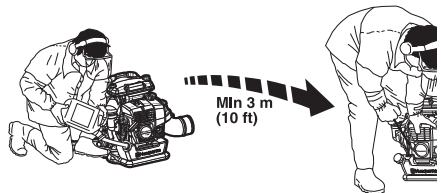

- Never start the machine:
 - If you have spilled fuel on it. Wipe off the spillage and allow remaining fuel to evaporate.
 - If you have spilled fuel on yourself or your clothes, change your clothes. Wash any part of your body that has come in contact with fuel. Use soap and water.
 - If the machine is leaking fuel. Check regularly for leaks from the fuel cap and fuel lines.

GENERAL SAFETY PRECAUTIONS

Transport and storage

- Store and transport the machine and fuel so that there is no risk of any leakage or fumes coming into contact with sparks or open flames, for example, from electrical machinery, electric motors, electrical relays/ switches or boilers.
- When storing and transporting fuel always use approved containers intended for this purpose.
- When storing the machine for long periods the fuel tank must be emptied. Contact your local petrol station to find out where to dispose of excess fuel. Empty the fuel tank and press the primer until all fuel has been emptied. Remove the spark plug and drop a spoon of 2-stroke oil in the cylinder. Turn over the engine a few times and then put the spark plug back in place.
- Ensure the machine is cleaned and that a complete service is carried out before long-term storage.
- Secure the machine during transport.
- Store the machine in a dry, cool, well-aired and dust-free location. Store the machine out of reach of children.



WARNING! Take care when handling fuel. Bear in mind the risk of fire, explosion and inhaling fumes.

Adjusting the harness



WARNING! The harness must always be worn when working with the machine. Failure to do so means you will be unable to manoeuvre safely and this can result in injury to yourself or others.

Make sure that the waist belt and chest belt are buttoned and correctly adjusted.

There is a risk that an unclosed belt can get stuck or sucked into the fan of the machine.



A correctly adjusted harness and machine significantly facilitates the work. Adjust the harness to give the best working position.



Tighten the side straps so that the pressure is evenly distributed across the shoulders.



Place the hip strap over the hip and not too far down on the stomach. Tighten the hip strap so that you feel the weight of the blower resting on your hip. Tighten and adjust the breast belt for the best working position.



SAFETY INSTRUCTIONS

Personal protective equipment



WARNING! You must use approved personal protective equipment whenever you use the machine. Personal protective equipment cannot eliminate the risk of injury but it will reduce the degree of injury if an accident does happen. Ask your dealer for help in choosing the right equipment. Please read the operator's manual carefully and make sure you understand the instructions before using the machine.



WARNING! Listen out for warning signals or shouts when you are wearing hearing protection. Always remove your hearing protection as soon as the engine stops.

- Gloves should be worn when necessary.



- Wear hearing protection that provides adequate noise reduction.



- Always wear approved eye protection. If you use a visor then you must also wear approved protective goggles. Approved protective goggles must comply with the ANSI Z87.1 standard in the USA or EN 166 in EU countries. Blows from branches or objects that are thrown can damage the eyes.

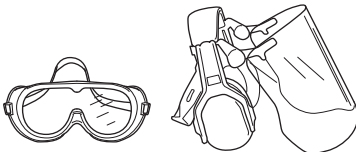

- Wear sturdy, non-slip boots.



- Always wear heavy, long pants, boots, gloves, and a long-sleeve shirt. To reduce the risk of injury associated with objects being drawn into rotating parts, do not wear loose clothing, scarves, jewelry, etc. Secure hair so it is above shoulder level.
- A breathing mask should be used when there is a risk of dust.

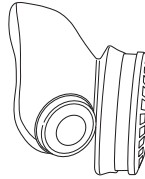

- Always have a first aid kit nearby.



Machine's safety equipment

This section describes the machine's safety equipment, its purpose, and how checks and maintenance should be carried out to ensure that it operates correctly. See the "What is what?" section to locate where this equipment is positioned on your machine.



WARNING! Never use a machine that has faulty safety equipment! Carry out the inspection, maintenance and service routines listed in this section.

Stop switch

Use the stop switch to switch off the engine.

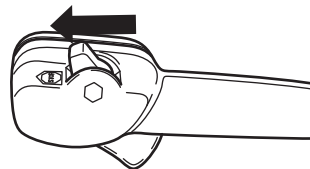

Remove the ignition cable and the spark plug to carry out inspection and maintenance.

SAFETY INSTRUCTIONS

Vibration damping system

Your machine is equipped with a vibration damping system that is designed to minimize vibration and make operation easier.

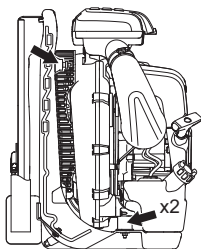

WARNING! Overexposure to vibration can lead to circulatory damage or nerve damage in people who have impaired circulation. Contact your doctor if you experience symptoms of overexposure to vibration. Such symptoms include numbness, loss of feeling, tingling, pricking, pain, loss of strength, changes in skin colour or condition. These symptoms normally appear in the fingers, hands or wrists. The risk increases at low temperatures.

Muffler

The muffler is designed to keep noise levels to a minimum and to direct exhaust fumes away from the user.

In countries that have a warm and dry climate there is a significant risk of fire. Consequently, we have equipped the muffler with a spark arrestor mesh mounted inside the muffler.

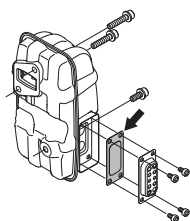

For mufflers it is very important that you follow the instructions on checking, maintaining and servicing your machine. See instructions under the heading Checking, maintaining and servicing the machine's safety equipment.



WARNING!

Bear in mind that: Engine exhaust fumes contain carbon monoxide, which can cause carbon monoxide poisoning. For this reason you should not start or run the machine indoors, or anywhere that is poorly ventilated.

The exhaust fumes from the engine are hot and may contain sparks which can start a fire. Never start the machine indoors or near combustible material!



WARNING! The inside of the muffler contain chemicals that may be carcinogenic. Avoid contact with these elements in the event of a damaged muffler.

Checking, maintaining and servicing the machine's safety equipment



WARNING! All servicing and repair work on the machine requires special training. This is especially true of the machine's safety equipment. If your machine fails any of the checks described below you must contact your service agent. When you buy any of our products we guarantee the availability of professional repairs and service. If the retailer who sells your machine is not a servicing dealer, ask him for the address of your nearest service agent.

Stop switch

- Start the engine and make sure the engine stops when you move the stop switch to the stop setting.

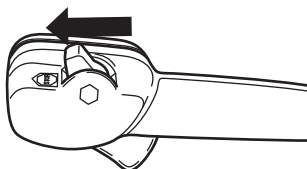

SAFETY INSTRUCTIONS

Vibration damping system

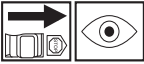

- Check the vibration damping units regularly for cracks or deformation. Replace them if damaged.

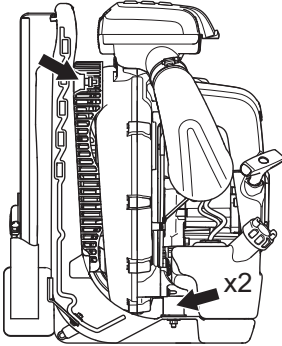

- Check that the vibration damping element is undamaged and securely attached.

Muffler



- Never use a machine that has a faulty muffler.



- Regularly check that the muffler is securely attached to the machine.

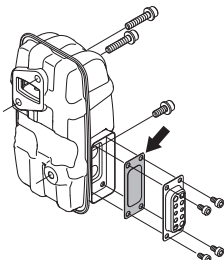

- The muffler on your machine is equipped with a spark arrestor mesh; this must be cleaned regularly. See the heading Muffler in the Maintenance chapter. A blocked mesh will cause the engine to overheat and

may lead to serious damage. Never use a muffler with a defective spark arrestor mesh.



WARNING! Never use a machine with faulty safety equipment. The machine's safety equipment must be checked and maintained as described in this section. If your machine fails any of these checks contact your service agent to get it repaired.

Air filter

Never use the leaf blower without an air filter or with a damaged or deformed filter element as unfiltered, dusty air can quickly destroy the engine.

General working instructions

IMPORTANT! This section considers basic safety rules when working with blowers. If you encounter a situation where you are uncertain how to proceed you should ask an expert. Contact your dealer or your service workshop. Avoid all usage which you consider to be beyond your capability.

Show consideration to persons in your surroundings by avoiding using the machine at unsuitable times, such as late in the evening or early in the morning. Reduce the noise levels by limiting the number of equipment units used simultaneously. Read through and follow the simple directions so that you disturb your surroundings as little as possible.

- Use the blower with the lowest possible throttle. It is seldom necessary to use full throttle, and many work procedures can be done at half throttle. A lower throttle means less noise and less dust, and it is also easier to keep control over the rubbish collected together/moved.
- Use a rake or a brush to release rubbish stuck to the ground.
- Hold the opening of the blower as close to the ground as possible. Utilise the entire length of the blow pipe to keep the air current close to the ground.
- Clean up afterwards. Make sure that you have not blown rubbish into someone's garden.
- Use the machine during normal working hours to avoid unnecessary noise. Avoid working early in the morning or late at night.



WARNING! Be aware of your surroundings. If anyone approaches your work area, set the throttle control to the lowest throttle until the person is at a safe distance. Direct the blower away from people, animals, play areas, open windows and cars etc.

SAFETY INSTRUCTIONS

Basic safety rules



- No unauthorised persons or animals may be present in the working area, which is 15 metres.
- Allow the engine to cool before refuelling.
- Keep all parts of your body away from hot surfaces.
- If the machine catches fire or other emergency occurs which forces you to release yourself from the machine, open the harness straps and let the machine fall backwards.
- The powerful currents of air can move objects at such a speed that they can bounce back and cause serious eye injuries.

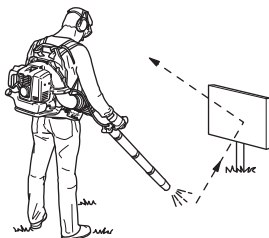

- Do not direct the air jet towards people or animals.
- Stop the engine before assembling or dismantling accessories or other parts.
- Do not use the machine in bad weather, such as dense fog, heavy rain, strong wind, intense cold, etc. Working in bad weather is tiring and can lead to dangerous conditions, e.g. slippery surfaces.
- Minimise the blowing time by lightly wetting dusty areas or using spray equipment.
- Make sure you can move and stand safely. Check the area around you for possible obstacles (roots, rocks, branches, ditches, etc.) in case you have to move suddenly. Take great care when working on sloping ground.



- Never put the machine down with the engine running unless you have it in clear sight.

- Engine exhaust fumes contain carbon monoxide, which can cause carbon monoxide poisoning. For this reason you should not start or run the machine indoors, or anywhere that is poorly ventilated.
- The blower must not be used while on a ladder or scaffolding, or in high places (such as roofs). Their work could result in severe injury.



- CAUTION! Do not use the machine unless you are able to call for help in the event of an accident.

Basic working techniques



WARNING! Watch out for thrown objects. Always wear eye protection. Stones, rubbish, etc. can be thrown up into the eyes causing blindness or serious injury. Keep unauthorised persons at a distance. Children, animals, onlookers and helpers should be kept outside the safety zone of 15 m. Stop the machine immediately if anyone approaches.



WARNING! Don't operate the blower if the exhaust gas outlet on the engine cover is covered by a wall and/or some other obstacles, the machine could get damage. Make sure that the distance is 50 cm or more from the obstacles during operation.



WARNING! Always stop the engine before cleaning.

- This blower is a backpack type, and is carried using a shoulder harness while operating. It is operated and controlled with the handle on the tube using the right hand.
- The speed of the air jet is regulated by means of the throttle. Select the speed best suited for respective tasks.

You can set the throttle position using the "stop switch" and by doing so not need to hold your finger on the throttle

SAFETY INSTRUCTIONS

all the time you are using the blower. Full throttle is obtained when the control is held back fully.

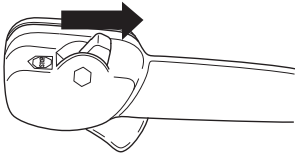

- Check that the air intake is not blocked, for example, by leaves or rubbish. A clogged air intake reduces the machine's blowing capacity and increases the engine's working temperature, which can result in engine failure. Stop the engine and remove the object.

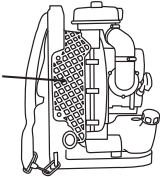

- Be aware of the wind direction. Work with the wind to make your work easier.
- Using the blower to move large piles is time consuming and creates unnecessary noise.
- Keep a good balance and a firm foothold.
- When work is finished the machine should be stored vertically.

ASSEMBLY

Assembling the blow pipe and control handle

- Connect the blower and control pipe with the flexible hose. Clamp both ends of the flexible hose in place. Use the accompanying hardware.

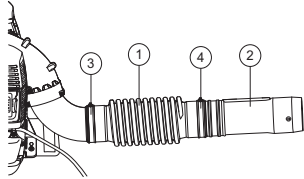

- 1 Flexible hose
- 2 Control pipe
- 3 Clamp
- 4 Clamp

NOTE!

Lubricate the pipes a little to facilitate assembly.

- Fasten the handle holder to the control pipe and tighten the knob on the holder. Please make sure to align the handle holder with the convex of the control pipe.

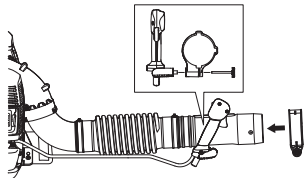

- Adjust the position and angle to achieve a comfortable working position, and tighten.
- Use the clamp to fasten the cabling to the flexible hose.

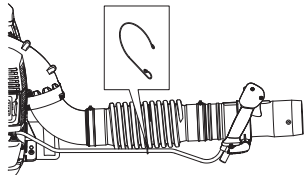

- Connect the straight pipe and pipe end. Push the pipes together and turn them so they lock.

Accessories

Handlebar

Disassemble the intermediate pipe. Disassemble the knob from the holder and push the holder on to the holder pipe. Assemble the knob and tighten.

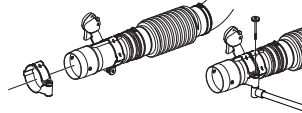

Assemble the intermediate pipe.

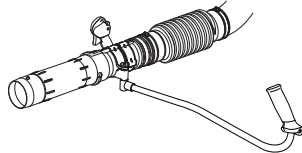

- If higher air speed is required, the round blow pipe is replaced by the flat nozzle.

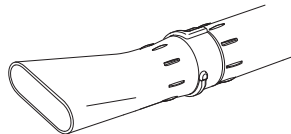

FUEL HANDLING

Fuel

CAUTION! The machine is equipped with a two-stroke engine and must always be run using a mixture of petrol and two-stroke oil. It is important to accurately measure the amount of oil to be mixed to ensure that the correct mixture is obtained. When mixing small amounts of fuel, even small inaccuracies can drastically affect the ratio of the mixture.



WARNING! Always ensure there is adequate ventilation when handling fuel.

Petrol



CAUTION! Always use a good quality petrol/oil mixture (at least 90 octane).



- The lowest recommended octane rating is 90. If you run the engine on a petrol with a lower octane rating than 90 this can cause knocking. This leads to an increased engine temperature, which can result in serious engine damage.
- When working at continuous high revs a higher octane rating is recommended. Use good quality unleaded petrol.

Husqvarna alkylate fuel

Husqvarna recommends the use of Husqvarna alkylate fuel for best performance. Husqvarna alkylate fuel is not available in all markets.

Ethanol blended fuel, E10 may be used (max 10% ethanol blend). Using ethanol blends higher than E10 will create lean running condition which can cause engine damage.

Two-stroke oil

- For best results and performance use HUSQVARNA two-stroke oil, which is specially formulated for our two-stroke engines. Mixture 1:50 (2%).
- If HUSQVARNA two-stroke oil is not available, you may use another two-stroke oil of good quality that is intended for air cooled engines. Contact your dealer when selecting an oil. Mixing ratio 1:33 (3%).
- Never use two-stroke oil intended for water-cooled outboard engines, sometimes referred to as outboard oil.
- Never use oil intended for four-stroke engines.

Petrol, litre	Two-stroke oil, litre
	2% (1:50)
5	0,10
10	0,20
15	0,30
20	0,40

Mixing

- Always mix the petrol and oil in a clean container intended for fuel.
- Always start by filling half the amount of the petrol to be used. Then add the entire amount of oil. Mix (shake) the fuel mixture. Add the remaining amount of petrol.
- Mix (shake) the fuel mixture thoroughly before filling the machine's fuel tank.



- Do not mix more than one month's supply of fuel at a time.
- If the machine is not used for some time the fuel tank should be emptied and cleaned.

FUEL HANDLING

Fueling



WARNING! Taking the following precautions, will lessen the risk of fire:

Refuel in a well ventilated area. Never fuel the machine indoors.

Do not smoke or place hot objects near fuel.

Always shut off the engine before refuelling.

Always stop the engine and let it cool for a few minutes before refuelling.

When refuelling, open the fuel cap slowly so that any excess pressure is released gently.

Tighten the fuel cap carefully after refuelling.

If you have spilled fuel on it. Wipe off the spillage and allow remaining fuel to evaporate.

Always move the machine away from the refuelling area and source before starting.

- Move the machine at least 3 m from the refuelling point before starting it.

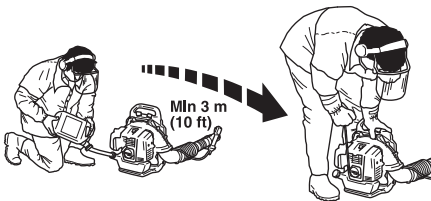

- Clean the area around the fuel cap. Contamination in the tank can cause operating problems.
- Ensure that the fuel is well mixed by shaking the container before filling the tank.
- Check the fuel level before each use and leave space for the fuel to expand, because the heat from the engine and the sun may otherwise cause the fuel to expand and overflow.

STARTING AND STOPPING

Starting and stopping



WARNING! Always move the machine away from the refuelling area and source before starting. Place the machine on a flat surface.

Make sure no unauthorised persons are in the working area. Otherwise there is a risk of serious personal injury. The safety distance is 15 meters.

The machine may only be started in its complete design. If the machine is started without all the guards fitted there is a risk of personal injuries.

Cold engine

Ignition: Set the stop switch to the start position. About one third open.

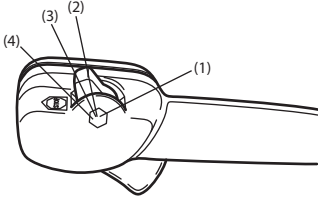

- 1 Full throttle
- 2 About one third open.
- 3 Idle speed
- 4 Stop switch

It is not allowed to set the stop switch in full throttle position.

Choke: Set the choke control in the choke position.

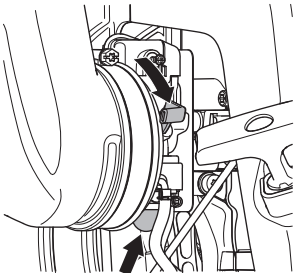

Primer bulb: Press the air purge repeatedly until fuel begins to fill the bulb. The bulb need not be completely filled.

Warm engine

Use the same starting procedure as for a cold engine but without setting the choke control in the choke position.

Starting

Hold the body of the machine on the ground using your left hand (CAUTION! Not with your foot!). Grip the starter handle, slowly pull out the cord with your right hand until you feel some resistance (the starter pawls grip), now quickly and powerfully pull the cord.

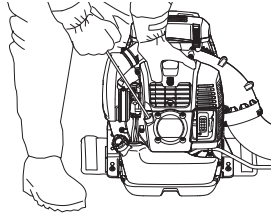

Never twist the starter cord around your hand.

Repeat pulling the cord until the engine starts. When the engine starts, return choke control to run position.

CAUTION! Do not pull the starter cord all the way out and do not let go of the starter handle when the cord is fully extended. This can damage the machine.

NOTE!

Air is released as soon as the engine is started, even when idling.

When the engine fails to start after several attempts due to overchoking, open the choke and repeat pulling the rope.

Set the required engine speed with the throttle control.

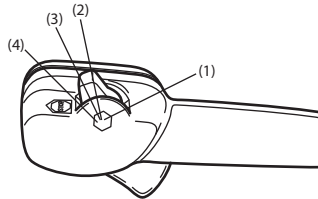

- 1 Full throttle
- 2 About one third open.
- 3 Idle speed
- 4 Stop switch

Stopping

The engine is stopped by moving the stop switch to the stop position.

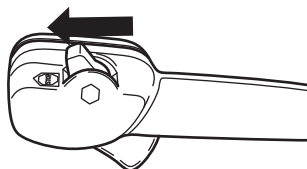

MAINTENANCE

General

Remove the ignition cable and the spark plug to carry out inspection and maintenance. Keep all parts of your body away from hot surfaces.

Carburettor

Adjustment of the idle speed

Before any adjustments are made, make sure that the air filter is clean and the air filter cover is fitted.

The factory idle speed setting is 2,000 rpm. Use the adjustment screw at the upper edge of the carburettor if the idle speed has to be adjusted.

Muffler

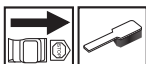

The muffler is designed to reduce the noise level and to direct the exhaust gases away from the operator. The exhaust gases are hot and can contain sparks, which may cause fire if directed against dry and combustible material.

The muffler is equipped with a special spark arrester mesh. The spark arrester mesh should be cleaned once a month. This is best done with a wire brush.

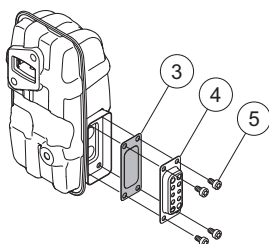

To remove the spark arrester mesh proceed as follows:

- Remove the exhaust duct (4, 5).
- Remove the spark arrester (3).
- Pull out the spark arrester mesh and clean using a wire brush. Replace the spark arrester mesh if it is defective.

CAUTION! Never use a machine with a defective muffler. Check regularly that the muffler is complete and secured correctly. (1), (2) Tighten the screws. 8-10Nm

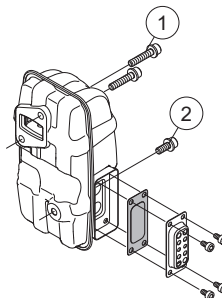

Check that the spark arrester and the exhaust duct are screwed in place correctly (5). Tighten to 2-3 Nm.



WARNING! The muffler gets very hot during use and remain so for some time after stopping. This also applies at idle speed. Contact can result in burns to the skin. Remember the risk of fire!

Cooling system



To keep the working temperature as low as possible the machine is equipped with a cooling system.

The cooling system consists of:

- Cooling fins on the cylinder.
- Air intake screen

Clean the cooling system with a brush once a week, more often in demanding conditions. A dirty or blocked cooling system results in the machine overheating which causes damage to the piston and cylinder. Check that the nozzles are not blocked.

MAINTENANCE

Air intake screen

Check that the air intake is not blocked on all sides including the underside, for example, by leaves or rubbish. A clogged air intake reduces the machine's blowing capacity and increases the engine's working temperature, which can result in engine failure. Stop the engine and remove the object.

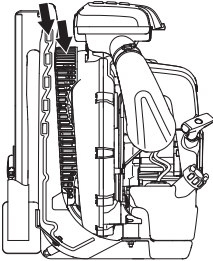

WARNING! Never use the blower if the screen is not in place. Before use, check that the screen is in place and undamaged.

Spark plug

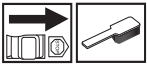

The spark plug condition is influenced by:

- Incorrect carburettor adjustment.
- An incorrect fuel mixture (too much or incorrect type of oil).
- A dirty air filter.

These factors cause deposits on the spark plug electrodes, which may result in operating problems and starting difficulties.

Clean the outside of the spark plug. Remove it and check the electrode gap. Adjust the gap to 0,6-0,7 mm or replace the spark plug. Check that the spark plug is fitted with a suppressor.

0,6-0,7 mm

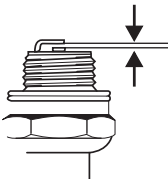

CAUTION! Always use the recommended spark plug type! Use of the wrong spark plug can damage the piston/cylinder.

Air filter

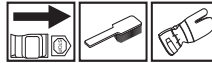

The air filter must be regularly cleaned to remove dust and dirt in order to avoid:

- Carburettor malfunctions.
- Starting problems.
- Loss of engine power.
- Unnecessary wear to engine parts.
- Excessive fuel consumption.

Clean the filter every 40 hours, or more regularly if conditions are exceptionally dusty.

Avoid contact with hot surfaces on muffler, cylinder etc. Contact can result in burns to the skin.

Cleaning the air filter

- Loosen the four fasteners holding the air filter cover and remove the filter. Wash the prefilter in warm soapy water.

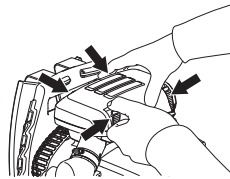

Clean the air filter. Do not clean the filter by tapping it against a hard surface. This will damage the filter. If the paper filter is still dirty it should be replaced with a new one.

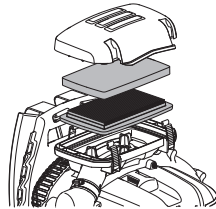

NOTE!

Never use oleaginous solvent to clean the air filter.

An air filter that has been in use for a long time cannot be cleaned completely. The filter must therefore be replaced with a new one at regular intervals. **A damaged air filter must always be replaced.**

- Refit the air filter and air filter cover.

MAINTENANCE

Maintenance schedule

Below you will find some general maintenance instructions. If you need further information please contact your service workshop.

Maintenance	Daily maintenance	Weekly maintenance	Monthly maintenance
Clean the outside of the machine.	X		
Check that the throttle control functions safely.	X		
Check that the stop switch works correctly.	X		
Clean the air filter. Replace if necessary.	X		
Check that nuts and screws are tight.	X		
Check that there are no fuel leaks from the engine, tank or fuel lines.	X		
Check the fuel filter for contamination and the fuel hose for cracks or other defects. Replace if necessary.	X		
Clean or replace the spark arrestor mesh on the muffler (only applies to mufflers without a catalytic converter).	X		
Check that all sides of the air intake screen are not blocked.	X		
Check the starter and starter cord.		X	
Check that the vibration damping elements are not damaged.		X	
Clean the outside of the spark plug. Remove it and check the electrode gap. Adjust the gap to 0,6-0,7 mm or replace the spark plug. Check that the spark plug is fitted with a suppressor.		X	
Clean the machine's cooling system.		X	
Clean the outside of the carburettor and the space around it.		X	
Check all cables and connections.			X
Replace the spark plug. Check that the spark plug is fitted with a suppressor.			X
Check and clean the spark arrestor mesh on the muffler (only applies to mufflers fitted with a catalytic converter).			X
Clean the fuel tank.			X

TECHNICAL DATA

Technical data

Technical data	570BTS	580BTS
Engine		
Cylinder displacement, cm ³	65.6	75.6
Idle speed, rpm	2000	2000
Max. engine output, acc. to ISO 8893, kW/ rpm		
Catalytic converter muffler	No	No
Speed-regulated ignition system	Yes	Yes
Ignition system		
Spark plug	NGK CMR7H	NGK CMR7H
Electrode gap, mm	0,6-0,7	0,6-0,7
Fuel and lubrication system		
Fuel tank capacity, litre	2,2	2,6
Weight		
Weight without fuel, kg	11,2	11,8
Noise emissions		
(see note 1)		
Sound power level, measured dB(A)	110	111
Sound power level, guaranteed L _{WA} dB(A)	110	112
Noise levels		
(see note 2)		
Equivalent sound pressure level at the operator's ear, measured according to EN15503 dB(A)	99	100
Vibration levels		
(see note 3)		
Equivalent vibration levels (a _{hv,eq}) at handles, measured according to EN15503, m/s ²	1,8	1.6
Fan performance		
Max. air velocity with blower nozzle, m/s:	106	92
Max air velocity with flat nozzle, m/s:	91	93
Air flow with standard nozzle, m ³ /min	22	26
Air flow with flat nozzle, m ³ /min:	24	25

Note 1: Noise emissions in the environment measured as sound power (L_{WA}) in conformity with EC directive 2000/14/EC. Reported sound power level for the machine has been measured with the original cutting attachment that gives the highest level. The difference between guaranteed and measured sound power is that the guaranteed sound power also includes dispersion in the measurement result and the variations between different machines of the same model according to Directive 2000/14/EC.

Note 2: The equivalent sound pressure level value is calculated with a work cycle of a duration of 1/7 for idling and 6/7 for racing. Reported data for equivalent sound pressure level for the machine has a typical statistical dispersion (standard deviation) of 1 dB(A).

Note 3: The equivalent vibration level value is calculated with a work cycle of a duration of 1/7 for idling and 6/7 for racing. Reported data for equivalent vibration level has a typical statistical dispersion (standard deviation) of 1 m/s².

TECHNICAL DATA

EC Declaration of Conformity (Applies to Europe only)

Husqvarna AB, SE-561 82 Huskvarna, Sweden, tel +46-36-146500, declares under sole responsibility that the blowers **Husqvarna 570BTS, 580BTS** with serial numbers dating 2014 and onwards (the year is clearly stated on the rating plate, followed by the serial number), comply with the requirements of the COUNCIL'S DIRECTIVE:

- of May 17, 2006 "relating to machinery" **2006/42/EC**.
- of December 15, 2004 "relating to electromagnetic compatibility" **2004/108/EC**.
- of May 8, 2000 "relating to the noise emissions in the environment" **2000/14/EC**. Conformity assessment according to Annex V.

For information relating to noise emissions, see the Technical data chapter. The following standards have been applied: **EN ISO 12100:2010, EN 15503:2009+A1:2013**

SMP Svensk Maskinprovning AB, Box 7035, SE-750 07 Uppsala, Sweden, has performed voluntary type examination on behalf of Husqvarna AB. The certificates are numbered:

SEC/10/2276 - 570BTS, **SEC/10/2277** - 580BTS

Huskvarna October 7, 2014



Per Gustafsson, Development manager (Authorized representative for Husqvarna AB and responsible for technical documentation.)

LIMITED WARRANTY

Limited warranty

Limited warranty

Should any failure occur on the product under normal operating conditions within the applicable warranty period, the failed part will be replaced or repaired free of charge by a Husqvarna authorized dealer.

WARRANTY PERIOD: Six (6) months after purchased by end-user subject to 12 months from produced month. (30 days if used for rental purpose)

THE PURCHASER SHALL BEAR COSTS OF TRANSPORTING THE UNIT TO AND FROM THE HUSQVARNA DEALER.

THE PURCHASER SHALL NOT BE CHARGED FOR DIAGNOSTIC LABOR WHICH LEADS TO THE DETERMINATION THAT A WARRANTED PART IS DEFECTIVE, IF THE DIAGNOSTIC WORK IS PERFORMED AT THE HUSQVARNA DEALER.

THE PURCHASER OR OWNER IS RESPONSIBLE FOR THE PERFORMANCE OF THE REQUIRED MAINTENANCE AS DEFINED BY THE MANUFACTURER IN THE OWNER/OPERATOR MANUAL.

ANY WARRANTED PART WHICH IS NOT SCHEDULED FOR REPLACEMENT AS REQUIRED MAINTENANCE, OR WHICH IS SCHEDULED ONLY FOR REGULAR INSPECTION TO THE EFFECT OF REPAIR OR "REPLACE AS NECESSARY" SHALL BE WARRANTED FOR THE WARRANTY PERIOD. ANY WARRANTED PART WHICH IS SCHEDULED FOR REPLACEMENT AS REQUIRED MAINTENANCE SHALL BE WARRANTED FOR THE PERIOD OF TIME UP TO THE FIRST SCHEDULED REPLACEMENT POINT FOR THE PART.

ANY REPLACEMENT PART THAT IS EQUIVALENT IN PERFORMANCE AND DURABILITY MAY BE USED IN NON-WARRANTY MAINTENANCE OR REPAIRS, AND SHALL NOT REDUCE THE WARRANTY OBLIGATION OF THE

COMPANY.

THE COMPANY IS LIABLE FOR DAMAGES TO OTHER ENGINE COMPONENTS CAUSED BY THE FAILURE OF A WARRANTED PART STILL UNDER WARRANTY.

THE WARRANTY DOES NOT APPLY TO THOSE UNITS WHICH HAVE BEEN DAMAGED BY NEGLIGENCE OF INSTRUCTION LISTED IN THE OWNER/OPERATOR MANUAL FOR PROPER USE AND MAINTENANCE OF THE UNITS ACCIDENT MISHANDLING, ALTERATION, ABUSE, IMPROPER LUBRICATION, USE OF ANY PARTS OR ACCESSORIES OTHER THAN THOSE SPECIFIED BY THE COMPANY, OR OTHER CAUSES BEYOND THE COMPANY'S CONTROL.

THIS WARRANTY DOES NOT COVER THOSE PARTS REPLACED BY NORMAL WEAR OR HARMLESS CHANGES IN THEIR APPEARANCE.

THERE ARE NO OTHER EXPRESS WARRANTIES.

ANY IMPLIED WARRANTY is limited to the duration of the limited warranty. Otherwise, this limited warranty is in lieu of all other expressed or implied warranties, including any warranty of **FITNESS FOR A PARTICULAR PURPOSE OR USE** and any implied warranty **MERCHANTABILITY** otherwise applicable to this product.

LIABILITIES FOR INCIDENTAL OR CONSEQUENTIAL DAMAGE UNDER ANY AND ALL WARRANTIES ARE EXCLUDED.

IF YOU NEED TO OBTAIN MORE INFORMATION, PLEASE CALL YOUR NEAREST SERVICE CENTER, OR CHECK PLEASE HUSQVARNA WEB SITE
<http://www.husqvarna.com>

www.husqvarna.com

CN - 原始说明书
GB - Original instruction

1157401-94



2016-04-14