

EasyCut Li-18/23 R
Art. 9823

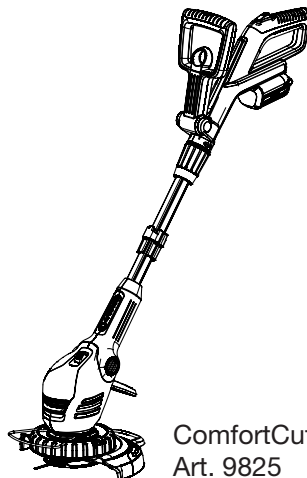

ComfortCut Li-18/23 R
Art. 9825

DE Betriebsanleitung
Accu-Turbotrimmer

EN Operating Instructions
Accu Turbotrimmer

FR Mode d'emploi
Coupe-bordures à batterie

NL Gebruiksaanwijzing
Accu-Turbotrimmer

SV Bruksanvisning
Accu-Turbotrimmer

DA Brugsanvisning
Accu-turbotrimmer

FI Käyttöohje
Accu-turbotrimmeri

NO Bruksanvisning
Batteri-turbotrimmer

IT Istruzioni per l'uso
Turbotrimmer a batteria

ES Instrucciones de empleo
Recortabordes con accu

PT Manual de instruções
Aparador de relva Accu-Turbotrimmer

PL Instrukcja obsługi
Podkaszarka akumulatorowa

HU Használati utasítás
Akkumulátoros dămilos
fűszegélynyíró

CS Návod k obsluze
Akumulátorový turbotrimmer

SK Návod na obsluhu
Akumulátorový turbotrimmer

EL Οδηγίες χρήσης
Επαναφορτιζόμενο κοιρευτικό
πετονιας

RU Инструкция по эксплуатации
Аккумуляторный турботриммер

SL Navodilo za uporabo
Akumulatorski turbo trimmer obrezovalnik

HR Upute za uporabu
Baterijski turbo trimmer za travu

SR/ BS Uputstvo za rad
Baterijska turbo trimmer-kosilica

UK Інструкція з експлуатації
Акумуляторний турботриммер

RO Instrucțiuni de utilizare
Turbotrimmer cu baterie

TR Kullanma Kılavuzu
Akülü Turbo Tirpan

BG Инструкция за експлоатация
Акумуляторен Турботриммер

SQ Manual përdorimi
Kositëse bari turbo me bateri

ET Kasutusjuhend
Akuga turbotrimmer

LT Eksploatavimo instrukcija
Akumuliatorinė turbo žolijaprovė

LV Lietošanas instrukcija
Turbotrimmeris ar akumulatoru

GARDENA EasyCut Li-18/23 R, ComfortCut Li-18/23 R

1. Safety Instructions	14
2. Assembly	16
3. Initial Operation	17
4. Operation	19
5. Storage	20
6. Maintenance	21
7. Troubleshooting	21
8. Available accessories	23
9. Technical Data	23
10. Service / Warranty	24

Original instructions.

Never operate the product when you are tired, ill or under the influence of alcohol, drugs or medicine.



This product may be used under supervision, or if instruction regarding the safe use of the product has been provided and the resulting dangers have been understood, by children aged 8 and above,

as well as by persons with physical, sensory or mental disabilities or a lack of experience and knowledge. Children must not be allowed to play with the product. Cleaning and user maintenance must not be performed by children without supervision. The use of this product by young people under the age of 16 is not recommended.

Intended use:

The GARDENA Turbotrimmer is designed for trimming and cutting areas of grass and lawns in private house and hobby gardens.

The Turbotrimmer must not be used in public facilities, parks, sports grounds, next to roads or in agriculture or forestry.

DANGER! Der GARDENA For safety reasons, the GARDENA Turbotrimmer must not be used for hedge trimming or for shredding for composting.

1. Safety Instructions

→ Please read the notes on safety on the Trimmer.

IMPORTANT!

Read the operator's manual carefully before use and keep for future reference.



DANGER! Eye and ear injuries!
→ Wear eye and hearing protection!

Symbols on the product:



CAUTION!

→ Please read the operating instructions before using this tool.



DANGER!

→ Keep your Turbotrimmer away from water and rain!

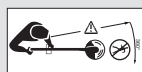

DANGER!

Risk of injury to other people!

→ Keep bystanders away.



Check your Trimmer before each use

→ Always visually inspect your Trimmer before each use.

→ Check that the ventilation slots are not obstructed in any way.

Do not use the trimmer if it is damaged or if safety devices (pressure switch, safety cover) and/or the blade holder are damaged or worn.

→ Never bypass the safety devices.

→ Inspect the area to be cut before you begin work. Remove any foreign objects and look out for foreign objects (such as stones, pieces of wood, strings and wires) while you are working.

→ However, should you encounter an obstacle during work, take the trimmer out of opera-

tion and remove the battery. Remove the obstacle; inspect the trimmer for potential damage and arrange for it to be repaired if necessary.

Use / responsibility



DANGER! Tool does not stop immediately when turned off! Keep hands and feet away from the work area until the blade is stationary!

The Trimmer can cause serious injuries.

→ Use the Trimmer only for the purpose specified in these operating instructions.

You are responsible for safety in the work area (2 metre radius).

→ Ensure that no other people (especially children) and animals are in close proximity to the danger area (15 metre radius).

Warning! When wearing hearing protection, and due to the noise produced by the unit, the operator may not notice persons approaching.

Remove the battery after use and regularly inspect the trimmer, especially the blade holder, for damage and arrange appropriate repair if necessary.

→ Always wear an eye shield or safety goggles!

→ Wear sturdy shoes and long trousers in order to protect your legs. Keep fingers and feet away from the plastic blade – especially during commissioning!

→ Always ensure that you have a secure foothold whilst working and that you keep your balance at all times.

Take extra care when walking backwards. You may stumble!

→ Only work in the daylight or when visibility is good.

→ Do not overreach. In order to prevent overtiredness, alternate working positions and ensure sufficient breaks are taken. This enables better control of the power tool in unexpected situations.

Interrupting work

→ Never leave the Trimmer unattended where you are working.

→ When stopping work, remove the battery and store the trimmer in a safe place.

→ If you stop work in order to move to another work area, the trimmer must be switched off, wait until the work tool is stationary and

remove the battery. Always carry the trimmer at the additional handle.

Familiarise yourself with the surroundings

→ Familiarise yourself with the surroundings and look out for possible dangers which you may not hear due to machine noise.

→ Never use the Trimmer when there is a risk of thunderstorms, when it is raining or in damp, wet areas.

→ Do not use the trimmer in the immediate vicinity of or in water (swimming pool, streams or garden ponds).

Battery safety

→ Please observe the safety instructions on the battery.



FIRE RISK! Short-circuit!

→ Do not bridge the contacts of the battery with metal components.



FIRE RISK!

The battery to be charged must be placed on a non-flammable, heat resistant and non-conductive surface while charging. Keep corrosive, flammable and easily combustible objects clear of the battery charger and the battery. Do not cover the battery charger and the battery while charging. Unplug the battery charger immediately in the event of smoke formation or fire.

Only use the original GARDENA Battery Charger for charging. The use of other battery chargers may damage the batteries irreparably and even cause a fire.



RISK OF EXPLOSION!

Protect battery from heat and fire. Do not leave on radiators or expose to strong sunshine for long periods.



Do not use the battery charger outdoors.

→ Protect the the battery charger from damp or wet areas.

Only use the battery in ambient temperatures of between 0 °C and 40 °C.

A non-functioning battery must be disposed of correctly. It may not be sent via post.

For further details, please contact your local disposal companies.

The battery charger should be checked regularly for signs of damage or ageing (brittleness) and may only be used if it is in perfect condition.

The charger unit provided may only be used to charge the rechargeable batteries supplied with the Turbotrimmer.

Non-rechargeable batteries must not be charged with this battery charger (danger of fire).

The Trimmer must not be operated during charging.

Only charge battery between 0 – 45 °C.
After heavy duty service allow battery to cool down first.

Only the original GARDENA battery may be used.

Storage

The trimmer must not be stored over 35 °C or under direct exposure to sunlight.

Never store the Trimmer with attached battery, this prevents misuse and accidents.

Do not store the trimmer in places with static electricity.

Warning! This unit makes an electromagnetic field while it operates. This field may under some conditions interfere with active or passive medical implants. To decrease the risk of conditions that can possibly injure or kill, we recommend persons with medical implants to speak with their physician and the medical implant manufacturer before operating.

Warning! Keep toddlers away when you assemble the unit. Small parts can be easily swallowed. There is also a risk that the polybag can suffocate toddlers.

2. Assembly

Assembling the trimmer:

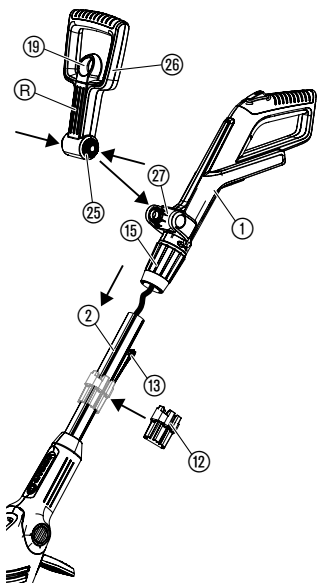

CAUTION!

The handle may only be assembled if the cable between the handle and the shaft is in a perfect condition. The handle may not be assembled if the cable is damaged. Contact GARDENA customer service in such a case.



CAUTION!

The trimmer may only be operated provided that the protective cover (11) is assembled.

- Carefully remove the handle (1) together with the shaft (2) from the packaging. In doing so, no stress may be exerted upon the cable.
- Ensure that the threaded collar (15) is in an open position (*padlock symbol open*).
- Slide the handle (1) onto the shaft (2) until it audibly engages. In doing so, the cable may not become twisted or jammed.
- By pulling on the handle (1), check whether it is firmly fixed to the shaft (2). Once assembled, the handle (1) and shaft (2) cannot be separated.
- Close the threaded collar (15) (*padlock symbol closed*).
- Pull the lock (19) belonging to the additional handle (26), push in both of the snap-fits (25) belonging to the additional handle (26) and, with the grooves (R) pointing forwards, snap them into the holder (27).

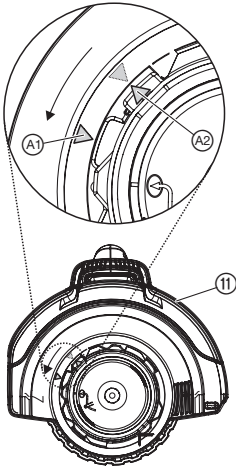
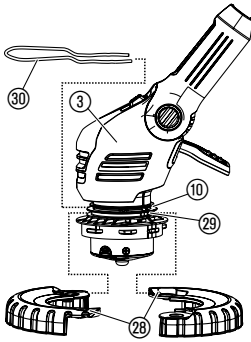

7. **Only for art. 9825:** Place both halves of the impeller 28 around the lower groove 29 of the trimmer head 3 and close until they audibly engage.
 8. From the front, push the plant guard 30 into the upper groove 10 of the trimmer head 3. In doing so, ensure that the impeller 28 can rotate freely (i.e. insert the bow with the kink pointing upwards).
 9. Place the protective cover 11 on top of the trimmer head 3.
 10. Turn the protective cover 11 until it can be pushed over the trimmer head entirely (the two arrows A1, A2 are directly across from each other).
 11. Rotate the protective cover 11 anti-clockwise until it audibly engages.
 12. Slightly widen the magazine 12 at the open point and slide onto the shaft 2.
 13. Slide up to 6 plastic blades 13 into the magazine 12 until the blades clamp into place.
- 6 plastic blades and a magazine for spare blades are included in the delivery. Up to 6 spare blades can be stored in the magazine.

For information regarding the assembly of the blade into the blade holders, please consult 7. Troubleshooting "Replacing the plastic blade".

3. Initial Operation

Charging the battery:



WARNING!

Overvoltage damages batteries and the battery charger.

→ **Ensure the correct mains voltage.**

Before using for the first time, the battery must be fully charged. Charging time (for uncharged battery) see 9. Technical Data.

The lithium-ion battery can be charged in any state of charge, and the charging process can be interrupted at any time without harming the battery (no memory effect).

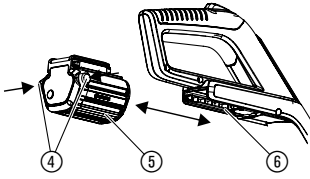

1. Depress both locking buttons (4) and remove the battery (5) from the battery holder (6) on the handle.
2. Plug the plug of the charger cable (7) into the battery (5).
3. Plug battery charger (8) into a mains socket.

When the charging control lamp (9) at the charger flashes green the battery is being charged.

When the charging control lamp (9) at the charger illuminates green the battery is completely charged
(For charging time, see 9. Technical Data.)

Battery charging status indicator during charging:

100 % charged	(L1), (L2) and (L3) illuminate (for 60 sec.)
66 – 99 % charged	(L1) and (L2) illuminate, (L3) flashes
33 – 65 % charged	(L1) illuminates, (L2) flashes
0 – 32 % charged	(L1) flashes

Check the charge status regularly while charging.

4. Once completely charged, disconnect the battery (5) from the battery charger (8). Disconnect the battery (5) from the battery charger (8) first, then unplug the battery charger (8).
5. Slide the battery (5) onto the battery holder (6) on the handle until it audibly engages.

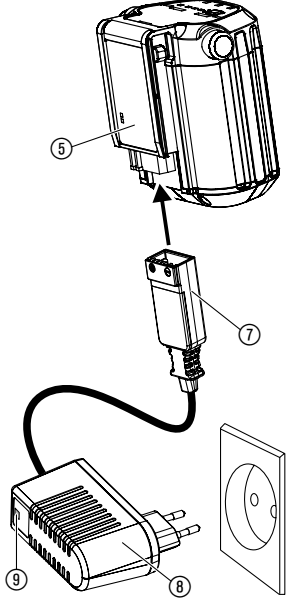

Avoid exhaustive discharge:

If the battery is empty, the full discharge protection automatically switches off the device to prevent the battery from discharging fully. To prevent the fully charged battery from self-discharging via the unplugged charger, it should be disconnected from the charger after charging. If the battery was stored for more than 1 year, it must be fully recharged.

If the battery was fully discharged, the charging indicator lamp (9) will flash rapidly at the start of charging (twice per second). If the charging indicator lamp (9) still flashes rapidly after 10 minutes, a fault has occurred (see 7. Troubleshooting). If the error-LED (W) on the battery flashes, a fault has occurred (see 7. Troubleshooting). In case of a completely empty battery it will take approx. 20 minutes until the LEDs on the battery will indicate charging. But the charging process is indicated by the flashing LED (9) on the charger.

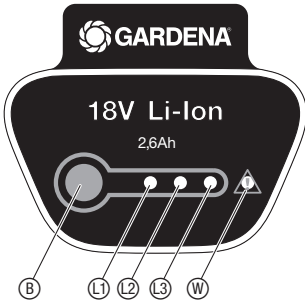

Battery charging status indicator during operation:

→ Press button (B) on the battery.

66 – 99 % charged	(L1), (L2) and (L3) illuminate
33 – 65 % charged	(L1) and (L2) illuminate
10 – 32 % charged	(L1) illuminates
0 – 10 % charged	(L1) flashes

4. Operation

DANGER!



Risk of injury if the Turbotrimmer does not switch off when you release the start button.

→ Never bypass the safety devices or switches (e.g. by tying the safety lock to the handle).

Risk of injury!

→ Remove the battery prior to each adjustment of the working position, to the shaft length, additional handle or plant guard!

Setting the working position:



Working position 1:
Standard trimming

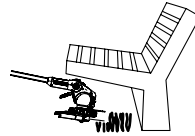

Working position 2:
Trimming beneath obstacles



Working position 3:
Vertical trimming of overhanging lawn edges

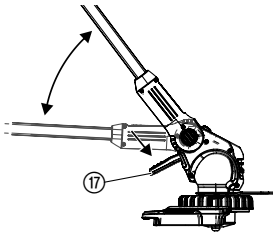

Working position 1:
For standard trimming.

Working position 2:

1. Press the foot pedal ⑰ and lower the shaft downwards into the desired working position.
2. Release the foot pedal ⑰ and allow the shaft to engage.

CAUTION! Avoid contact between the ground and the trimmer head in working position 1 + 2.

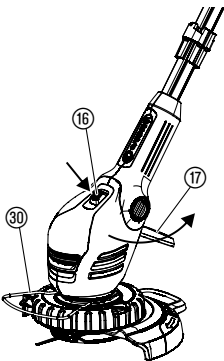

Working position 3 (only for art. 9825):

The upright must be in the uppermost position in working position 3.

1. Turn the plant guard ⑳ by 90° to its **parking position** until it locks into place.
2. Press the foot pedal ⑰ and move the upright into the uppermost position.
3. Press the button ⑯ and rotate the trimmer head from 0° to 90° until it engages.
4. With the impeller, move the trimmer along the lawn edge.

CAUTION! The trimmer may only be used provided that the trimmer head is engaged at an angle of 0° or 90°.

Setting the trimmer to body height:

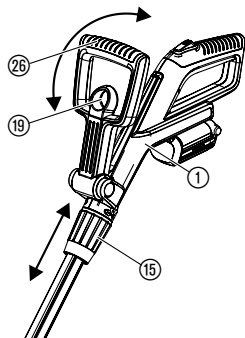

Adjusting the plant guard:

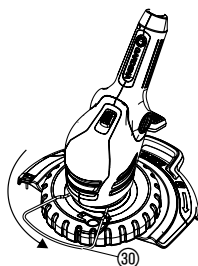

Working position

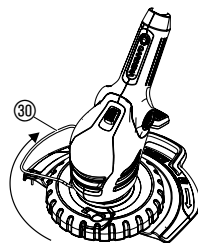

Parking position

→ Turn plant guard 30 through 90° into the required position until it locks into place.

Starting the trimmer:

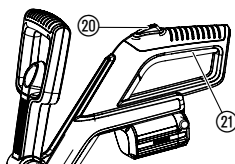

Setting the shaft length:

→ Loosen the clamping sleeve 15, extend the handle 1 to the desired shaft length and re-tighten the threaded collar 15.

The clamping sleeve 15 must be fastened firmly enough to prevent the shaft from being moved.

Setting the additional handle:

→ Pull the lock 19 belonging to the additional handle 26, set the additional handle 26 to the desired incline and release the lock 19.

If the trimmer is correctly set to the body height, the posture is upright and the trimmer head in **working position 1** is tilted forwards slightly.

→ Hold the trimmer by the handle 1 and additional handle 26 in such a manner that the trimmer head is tilted forwards slightly.

Switching the trimmer on:

1. Press and hold the safety lock 20 and then press the start button 21 on the handle.
2. Release the safety lock 20 again.

Switching the trimmer off:

→ Release the start button 21 on the handle.

5. Storage

To put into storage:

The product must be stored away from children.

1. Charge battery.
2. Store your Turbotrimmer in a dry place where it is protected from frost.

Recommendation:

The trimmer can be suspended by the handle. The trimmer head is not placed upon any unnecessary strain if stored in a suspended manner.

Disposal:
(in accordance with
RL2012/19/EC)



The product must not be disposed of to normal household waste. It must be disposed of in line with local environmental regulations.
→ Important! Dispose of the product through or via your municipal recycling collection centre.

Disposal of the battery:



The GARDENA battery contains lithium-ion cells that should not be disposed of with normal household waste at the end of its life.

Important!

Dispose of the batteries through or via your municipal recycling collection centre.

1. Discharge lithium-ion batteries completely.
2. Dispose of lithium-ion batteries properly.

6. Maintenance

DANGER!



Risk of injury from blade!

→ Remove the battery immediately before maintenance!

Risk of injury and risk of damage to property!

→ Never clean the trimmer with water or with a water jet (in particular a high-pressure water jet).

Cleaning the trimmer:

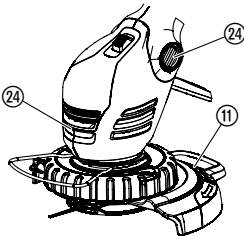

The ventilation slots must always be free of dirt.

→ Clean all moving parts after each use, and especially remove any grass and dirt from the cover (11) and ventilation slots (24).

7. Troubleshooting

DANGER!
Risk of cutting injuries!



Replacing the plastic blade:

Risk of injury from blade!

→ Remove the battery immediately in the event of faults!



DANGER! Risk of cutting injuries!

→ Never use metal cutting elements or spare parts and accessories not intended for use by GARDENA.

The blades may only become worn to half the original length at most. Only use original GARDENA Spare Blades. Spare blades are available from your GARDENA dealer or direct from GARDENA Service.

- GARDENA Spare Blades for Turbotrimmer

Art. No. 5368

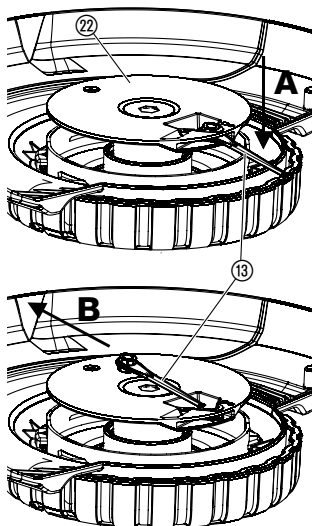

Disassembling the plastic blade:

1. Turn the trimmer over.
2. Press end of blade down slightly (A), slide blade (13) inside through blade carrier (22) (B) and pull out.

Assembling the plastic blade:

→ Slide new blade (13) from inside through slot in metal of blade carrier (22) until it snaps into place.

When the new blade is correctly inserted, it can be moved more easily.

Problem	Possible Cause	Remedy
The Trimmer is not cutting cleanly or not cutting at all	Blade worn or too short.	→ Replace blade.
	Blade broken off.	→ Replace blade.
The trimmer vibrates severely	The blade is excessively worn and creates an unbalance.	→ Replace blade.
The trimmer does not start	Battery is flat.	→ Charge battery (see 3. Initial Operation).
	Battery not pushed onto the handle properly.	→ Push battery onto the handle and make sure that the locking buttons snap in correctly.
	Motor blockage.	→ Unblock and restart the device.
The trimmer stops. Error-LED (9) flashes	Battery overload.	→ Wait for 10 sec. Press button (6) on the battery and restart.
	High temperature. The allowed operation temperature was exceeded.	→ Leave battery to cool for approx. 15 min. Press button (6) on the battery and restart.
Charging control lamp (9) on the charger does not illuminate	Battery charger or charging cable not plugged in properly.	→ Plug in battery charger and charging cable properly.
Charging control lamp (9) on the charger flashes red	Charging error.	→ Unplug charger and plug in again.
The trimmer stops. Error-LED (9) flashes	Battery error / battery defective.	→ Press button (6) on the battery and restart.
The battery can no longer be charged	Battery is defective.	→ Replace the battery (Art. No. 9839).

Only an original GARDENA BLi-18 Replaceable Battery (Art. 9839) may be used. This can be obtained from your GARDENA dealer or directly from GARDENA Service.



For any other malfunctions please contact the GARDENA service department. Repairs must only be carried out by GARDENA service departments or specialist dealers authorised by GARDENA.

8. Available accessories

GARDENA Replacement Battery BLi-18	Battery for additional duration or for replacement.	Art. No. 9839
GARDENA Battery Charger 18 V	Charger to charge the GARDENA Batteries BLi-18.	Art. No. 8833
GARDENA Spare Blades for Turbotrimmer		Art. No. 5368
GARDENA Replacement blade carrier	Available via the GARDENA Service.	

9. Technical Data

Turbotrimmer	EasyCut Li-18/23 R (Art. No. 9823)	ComfortCut Li-18/23 R (Art. No. 9825)
Cutting width	230 mm	230 mm
Rpm of blade carrier	approx. 9300 rpm	approx. 9300 rpm
Weight including battery	approx. 2.8 kg	approx. 3.1 kg
Workplace-related emission values $L_{pa}^{1)}$	75 dB (A)	68 dB (A)
Uncertainty k_{pa}	3 dB (A)	3 dB (A)
Noise level $L_{WA}^{2)}$	measured 83 dB (A) / guaranteed 88 dB (A)	measured 82 dB (A) / guaranteed 86 dB (A)
Uncertainty k_{WA}	4.5 dB (A)	4.2 dB (A)
Hand/arm vibration $a_{vhw}^{1)}$	< 2.5 m/s ²	< 2.5 m/s ²
Uncertainty k_a	1.5 m/s ²	1.5 m/s ²
Battery	lithium ion (18 V)	
Battery capacity	2.6 Ah	
Battery charging time	approx. 3.5 h 80 % / approx. 5 h 100 %	
Idling time*	approx. 60 min. (with full battery)	
Battery charger		
Mains voltage	230 V / 50 – 60 Hz	
Max. output current	600 mA	
Output voltage	18 V (DC)	

Measuring process complying with ¹⁾ IEC 60335-2-91 ²⁾ RL 2000/14/EC.

* The actual running time may differ from the stated idle time depending on application, type of cuttings and state of maintenance.



The stated vibration emission value has been measured according to a standardised test procedure and can be used for comparison of one electric power tool with another. It can also be used for preliminary evaluation of exposure. The vibration emission value can vary during actual use of the electric power tool.

10. Service/Warranty

Service:

Please contact the address on the back page.

Warranty:

In the event of a warranty claim, no charge is levied to you for the services provided.

GARDENA Manufacturing GmbH offers a two-year warranty (effective as of the date of purchase) for this product. This warranty includes all significant defects of the product that can be proved to be material or manufacturing faults.

This warranty is fulfilled by supplying a fully functional replacement product or by repairing the faulty product sent to us free of charge; we reserve the right to choose between these options.

This service is subject to the following provisions:

- The product was used for its intended purpose as per the recommendations in the operating instructions.

- Neither the purchaser nor a third party has attempted to repair the product.

This manufacturer's warranty does not affect warranty entitlements against the dealer/retailer.

If problems arise with this product, please contact our Service department or send the defective product along with a brief description of the fault to GARDENA Manufacturing GmbH, making sure to have sufficiently covered any shipping costs and to have followed the relevant postage and packaging guidelines. A warranty claim must be accompanied by a copy of the proof of purchase.

Consumables:

The blade and blade holder are consumables and are not included in the warranty.

DE Produkthaftung

Wir weisen ausdrücklich darauf hin, dass wir in Übereinstimmung mit dem Produkthaftungsgesetz nicht für Schäden haften, die durch unsere Produkte entstehen, wenn diese unsachgemäß und nicht durch einen von uns autorisierten Servicepartner repariert wurden oder wenn keine Original GARDENA Teile oder von uns zugelassene Teile verwendet wurden.

EN Product liability

In accordance with the German Product Liability Act, we hereby expressly declare that we accept no liability for damage incurred from our products where said products have not been properly repaired by a GARDENA-approved service partner or where original GARDENA parts or parts authorised by GARDENA were not used.

FR Responsabilité

Conformément à la loi relative à la responsabilité du fait des produits défectueux, nous déclarons expressément par la présente que nous déclinons toute responsabilité pour les dommages résultant de nos produits, si lesdits produits n'ont pas été correctement réparés par un partenaire d'entretien agréé GARDENA ou si des pièces d'origine GARDENA ou des pièces agréées GARDENA n'ont pas été utilisées.

NL Productaansprakelijkheid

Conform de Duitse wet inzake productaansprakelijkheid verklaren wij hierbij uitdrukkelijk dat wij geen aansprakelijkheid aanvaarden voor schade ontstaan uit onze producten waarbij deze producten niet zijn gerepareerd door een GARDENA-erkende servicepartner of waarbij geen originele GARDENA-onderdelen of onderdelen die door GARDENA zijn goedgekeurd zijn gebruikt.

SV Produktsvar

I enlighet med tyska produktansvarslagar förklarar vi härmed uttryckligen att vi inte åtar oss något ansvar för skador som orsakas av våra produkter där produkterna inte har genomgått korrekt reparation från en GARDENA-godkänd servicepartner eller där originaldelar från GARDENA eller delar godkända av GARDENA inte använts.

DA Produktsvar

I overensstemmelse med den tyske produktansvarslov erklærer vi hermed udtrykkeligt, at vi ikke påtager os noget ansvar for skader på vores produkter, hvis de pågældende produkter ikke er blevet repareret korrekt af en GARDENA-godkendt servicepartner, eller hvor der ikke er brugt originale GARDENA-reservedele eller godkendte reservedele fra GARDENA.

FI Tuotevastuu

Saksan tuotevastuulain mukaisesti emme ole vastuussa laitteiden vaurioista, jos korjauksia ei ole tehnyt GARDENAn hyväksymä huoltoliike tai jos niiden syyinä on muiden kuin alkuperäisten GARDENA-varaosien tai GARDENAn hyväksymien varaosien käyttö.

IT Responsabilità del prodotto

In conformità con la Legge tedesca sulla responsabilità del prodotto, con la presente dichiariamo espressamente che decliniamo qualsiasi responsabilità per danni causati dai nostri prodotti qualora non siano stati correttamente riparati presso un partner di assistenza approvato GARDENA o laddove non siano stati utilizzati ricambi originali o autorizzati GARDENA.

ES Responsabilidad sobre el producto

De acuerdo con la Ley de responsabilidad sobre productos alemana, por la presente declaramos expresamente que no aceptamos ningún tipo de responsabilidad por los daños ocasionados por nuestros productos si dichos productos no han sido reparados por un socio de mantenimiento aprobado por GARDENA o si no se han utilizado piezas originales GARDENA o piezas autorizadas por GARDENA.

PT Responsabilidade pelo produto

De acordo com a lei alemã de responsabilidade pelo produto, declaramos que não nos responsabilizamos por danos causados pelos nossos produtos, caso os tais produtos não tenham sido devidamente reparados por um parceiro de assistência GARDENA aprovado ou se não tiverem sido utilizadas peças GARDENA originais ou peças autorizadas pela GARDENA.

PL Odpowiedzialność za produkt

Zgodnie z niemiecką ustawą o odpowiedzialności za produkt, niniejszym wyraźnie oświadczamy, że nie ponosimy żadnej odpowiedzialności za szkody poniesione na skutek użytkowania naszych produktów, w przypadku gdy naprawa tych produktów nie była odpowiednio przeprowadzana przez zatwierdzonego przez firmę GARDENA partnera serwisowego lub nie stosowano oryginalnych części GARDENA albo części autoryzowanych przez tę firmę.

HU Termékszavatosság

A németországi termékszavatossági törvénnyel összhangban ezzel nyomatékosan kijelentjük, hogy nem vállalunk felelősséget a termékeinkben keletkezett olyan károkért, amelyek valamely GARDENA által jóváhagyott szervizpartner által nem megfelelően végzett javításból adódtak, vagy amely során nem eredeti GARDENA alkatrészeket vagy a GARDENA által jóváhagyott alkatrészeket használtak fel.

CS Odpovědnost za výrobek

V souladu s německým zákonem o odpovědnosti za výrobek tímto výslovně prohlašujeme, že nepřijímáme žádnou odpovědnost za poškození vzniklá na našich výrobcích, kdy zmíněné výrobky nebyly řádně opraveny schváleným servisním partnerem GARDENA nebo kdy nebyly použity originální náhradní díly GARDENA nebo náhradní díly autorizované společností GARDENA.

SK Zodpovednosť za produkt

V súlade s nemeckými právnymi predpismi upravujúcimi zodpovednosť za výrobok týmto výslovne prehlasujeme, že nenesieme žiadnu zodpovednosť za škody spôsobené našimi výrobkami, v prípade ktorých neboli náležité opravy vykonané servisným partnerom schváleným spoločnosťou GARDENA alebo neboli použité diely spoločnosti GARDENA alebo diely schválené spoločnosťou GARDENA.

EL Ευθύνη προϊόντος

Σύμφωνα με τον γερμανικό νόμο περί Ευθύνης για τα Προϊόντα, με το παρόν δηλώνουμε ρητώς ότι δεν αποδεχόμαστε καμία ευθύνη για τυχόν ζημιές που προκύπτουν από τα προϊόντα μας εάν αυτά δεν έχουν επισκευαστεί σωστά από κάποιον εγκεκριμένο συνεργάτη επισκευών της GARDENA ή εάν δεν έχουν χρησιμοποιηθεί αυθεντικά εξαρτήματα GARDENA ή εξαρτήματα εγκεκριμένα από την GARDENA.

SL Odgovornost proizvajalca

V skladu z nemškimi zakoni o odgovornosti za izdelke, izrecno izjavljajo, da ne sprejemamo nobene odgovornosti za škodo, ki jo povzročijo naši izdelki, če teh niso ustrezno popravili GARDENINI odobreni servisni partnerji ali pri tem niso bili uporabljeni originalni GARDENINI nadomestni deli ali GARDENINIMI homologiranimi nadomestnimi deli.

HR Pouzdanost proizvoda

Sukladno njemačkom zakonu o pouzdanosti proizvoda, ovime izričito izjavljujemo kako ne prihvaćamo nikakvu odgovornost za oštećenja na našim proizvodima nastala uslijed neispravnog popravka od strane servisnog partnera kojeg odobrava GARDENA ili uslijed nekorištenja originalnih GARDENA dijelova ili dijelova koje odobrava GARDENA.

RO Răspunderea pentru produs

În conformitate cu Legea germană privind răspunderea pentru produs, declarăm în mod expres prin prezentul document că nu acceptăm nicio răspundere pentru defecțiunile suferite de produsele noastre atunci când acestea nu au fost reparate în mod corect de un atelier de service partener, aprobat de GARDENA, sau când nu au fost utilizate piese GARDENA originale sau piese autorizate de GARDENA.

BG Отговорност за вреди, причинени от стоки

Съгласно германския Закон за отговорността за вреди, причинени от стоки, с настоящото изрично декларираме, че не носим отговорност за щети, причинени от нашите продукти, ако те не са били правилно ремонтирани от одобрен от GARDENA сервиз или ако не са използвани оригинални части на GARDENA или части, одобрени от GARDENA.

ET Tootevastutus

Vastavalt Saksamaa tootevastutusseadusele deklareerime kaesolevaga selgesõnaliselt, et me ei kannu mingisugust vastutust meie toodetest tingitud kahjude eest, kui need tooted ei ole korrektselt parandatud GARDENA heakskiidetud hoolduspartneri poolt või kui parandamisel ei ole kasutatud GARDENA originaalosi või GARDENA volitatud osi.

LT Gaminio patikimumas

Mes aiškiai pareiškiamo, kad, atsižvelgiant į Vokietijos gaminių patikimumo įstatymą, nepriisiame atsakomybės dėl bet kokios žalos, patirtos dėl mūsų gaminių, jeigu jie buvo netinkamai taisomi arba jų dalys buvo pakeistos neoriginaliomis GARDENA dalimis ar nepatvirtintomis dalimis, arba jeigu remonto darbai buvo atliekami ne GARDENA techninės priežiūros centro specialistų.

LV Atbildība par produkcijas kvalitāti

Saskaņā ar Vācijas likumu par atbildību par produkcijas kvalitāti ar šo mēs paziņojam, ka neuzņemamies atbildību par bojājumiem, kas radušies, lietojot mūsu izstrādājumus, kuru remontu nav veicis uzņēmuma GARDENA apstiprināts apkopes partneris vai kuru remontam netika izmantotas oriģinālās GARDENA detaļas vai detaļas, kuru lietošanu apstiprinājis uzņēmums GARDENA.

<p>DE EU-Konformitätserklärung</p> <p>Der Unterzeichner, Husqvarna AB, 561 82 Huskvarna, Schweden, bescheinigt hiermit, dass die nachstehend aufgeführten Geräte bei Verlassen des Werks die harmonisierten EU-Leitlinien, EU-Normen für Sicherheit und besondere Normen erfüllen. Dieses Zertifikat verliert seine Gültigkeit, wenn die Geräte ohne unsere Genehmigung verändert werden.</p>	<p>HU EK megfeleléségi nyilatkozat</p> <p>Alulírott Husqvarna AB, 561 82 Huskvarna, Svédország ezzel tanúsítja, hogy az alábbiakban leírt egységek a gyár elhagyásakor megfelelték a harmonizált uniós előírásoknak és biztonsági és termékspecifikus szabványoknak. Ez a tanúsítvány érvényes veszt, ha az egységeket jóváhagyásunk nélkül átalakítják.</p>
<p>EN EC Declaration of Conformity</p> <p>The undersigned, Husqvarna AB, 561 82 Huskvarna, Sweden, hereby certifies that, when leaving our factory, the units indicated below are in accordance with the harmonised EU guidelines, EU standards of safety and product specific standards. This certificate becomes void if the units are modified without our approval.</p>	<p>CS Prohlášení o shodě ES</p> <p>Niže uvedená společnost Husqvarna AB, 561 82 Huskvarna, Švédsko, tímto potvrzuje, že při opuštění naší továrny jsou jednotky uvedené níže v souladu s harmonizačními pokyny EU, standardy EU ohledně bezpečnosti a specifickými produktovými standardy. Tento certifikát pozbyvá platnosti, pokud dojde k úpravě jednotek bez našeho schválení.</p>
<p>FR Déclaration de conformité CE</p> <p>Le constructeur, soussigné : Husqvarna AB, 561 82 Huskvarna, Suède, déclare qu'à la sortie de ses usines le matériel neuf désigné ci-dessous était conforme aux prescriptions des directives européennes énoncées ciaprès et conforme aux règles de sécurité et autres règles qui lui sont applicables dans le cadre de l'Union européenne. Toute modification apportée à cet appareil sans notre accord annule la validité de ce certificat.</p>	<p>SK EÚ vyhlásenie o zhode</p> <p>Dolu podpísaná spoločnosť Husqvarna AB, 561 82 Huskvarna, Švédsko týmto osvedčuje, že nižšie uvedené jednotky boli v súlade s harmonizačnými usmerneniami EÚ, normami EÚ v oblasti bezpečnosti a špecifickými normami týkajúcimi sa produktu v čase opustenia výrobného závodu. Toto osvedčenie stráca platnosť, ak boli jednotky zmenené bez nášho súhlasu.</p>
<p>NL EG-conformiteitsverklaring</p> <p>De ondergetekende, Husqvarna AB, 561 82 Huskvarna, Zweden, verklaart hierbij dat de producten die hieronder staan vermeld, wanneer ze onze fabriek verlaten, in overeenstemming zijn met de geharmoniseerde Europese richtlijnen, EU-normen voor veiligheid en productspecifieke normen. Dit certificaat vervalt als de producten worden aangepast zonder onze toestemming.</p>	<p>EL Δήλωση Συμμόρφωσης EK</p> <p>Η υπογεγραμμένη εταιρεία, Husqvarna AB, 561 82 Huskvarna, Σουηδία, πιστοποιεί ότι, κατά την έξοδο από το εργοστάσιο, οι μονάδες που αναφέρονται κατωτέρω συμμορφώνονται με τις ευρωπαϊκές οδηγίες ΕΕ, τα πρότυπα ασφαλείας της ΕΕ και τα συγκεκριμένα πρότυπα προϊόντος. Αυτό το πιστοποιητικό καθίσταται άκυρο εάν οι μονάδες έχουν τροποποιηθεί χωρίς την έγκρισή μας.</p>
<p>SV EG-försäkran om överensstämmelse</p> <p>Undertecknad firma Husqvarna AB, 561 82 Huskvarna, Sverige, intygar härmed att nedan nämnda produkter, när de lämnar vår fabrik, överensstämmer med EU:s riktlinjer, EU:s säkerhetsstandarder och produktspecifika standarder. Detta intygg skall ogiltigförklaras om produkten ändras utan vårt godkännande.</p>	<p>SL Izjava ES o skladnosti</p> <p>Spodaj podpisana, Husqvarna AB, 561 82 Huskvarna, Švedska, s to izjavo potrjuje, da je bila spodaj navedena enota ob izhodu iz tovarne sklada v usklajenimi smernicami EU, standardi EU za varnost in standardi, specifičnimi za izdelek. Izjava postane neveljavna v primeru neodobrene spremembe enote.</p>
<p>DA EU-øverensstemmelseserklæring</p> <p>Undertegnede, Husqvarna AB, 561 82 Huskvarna, Sverige erklærer hermed, at nedenfor anførte enheder er i overensstemmelse med de harmoniserede EU-retningslinjer, EU-standarder for sikkerhed og produktspecifikke standarder, når de forlader fabrikken. Denne erklæring ugyldiggøres, hvis enhederne ændres uden vores godkendelse.</p>	<p>HR Izjava o uskladenosti EZ</p> <p>Niže potpisana Husqvarna AB, 561 82 Huskvarna, Švedska, ovime potvrđuje kako su u nastavku navedene jedinice prilikom napuštanja tvornice bile u skladu s uskladenim smjernicama EU, EU sigurnosnim standardima i standardima specifičnima za proizvod. Ova certifikacija poništava se ako se jedinice izmjenjuju bez odobrenja.</p>
<p>FI EY-vaatimustenmukaisuusvakuutus</p> <p>Husqvarna AB, 561 82 Huskvarna, Ruotsi, vakuuttaa täten, että alla mainitut laitteet ovat tehtaalta lähtiesään yhdenmukaiset EU-säännösten, EU:n turva-standardien ja tuotekohtaisten standardien mukaisia. Tämä vakuutus mitätöityy, jos laitteita muokataan ilman hyväksyntäämme.</p>	<p>RO Declarație de conformitate CE</p> <p>Subscrisa, Husqvarna AB, 561 82 Huskvarna, Suedia, certifică prin prezenta că, la momentul ieșirii din fabrica noastră, unitățile indicate mai jos sunt în conformitate cu directivele UE armonizate, cu standardele UE de siguranță și cu standardele specifice ale produsului. Prezentul certificat devine nul dacă unitățile sunt modificate fără aprobarea noastră.</p>
<p>IT Dichiarazione di conformità CE</p> <p>La sottoscritta Husqvarna AB, 561 82 Huskvarna, Svezia, certifica che il prodotto qui di seguito indicato, nei modelli da noi commercializzati, è conforme alle direttive armonizzate UE nonché agli standard di sicurezza UE e agli standard specifici di prodotto. Qualunque modifica apportata al prodotto senza nostra specifica autorizzazione invalida la presente dichiarazione.</p>	<p>BG Декларация за съответствие на ЕО</p> <p>С настоящото долуподписаната, Husqvarna AB, 561 82 Huskvarna, Швеция, удостоверява, че при напускане на фабриката модулите, посочени по-долу, са в съответствие с хармонизираните директиви на ЕС, стандартите на ЕС за безопасност и специфичните за продукта стандарти. Този сертификат става невалиден, ако модулите са променени без нашето одобрение.</p>
<p>ES Declaración de conformidad CE</p> <p>El abajo firmante, Husqvarna AB, 561 82 Huskvarna, Suecia, certifica por la presente que, cuando salen de la fábrica, las unidades indicadas a continuación cumplen las normas de armonización de la UE, las normas de la UE sobre seguridad y las normas específicas del producto. Este certificado quedará sin efecto si se modifican las unidades sin nuestra autorización.</p>	<p>ET EÜ vastavusdeklaratsioon</p> <p>Allkirjutatu Husqvarna AB, 561 82 Huskvarna, Rootsi, kinnitab käesolevaga, et tehased väljumeis vastavad alpool nimetatud seadmed harmoneeritud EL-i suunistele, EL-i ohutusstandarditele ja tootele eriomastele standarditele. See vastavuskinnitus kaotab kehtivuse, kui seadet muudetakse ilma meie heakskiuduta.</p>
<p>PT Declaração de conformidade CE</p> <p>O abaixo assinado, Husqvarna AB, 561 82 Huskvarna, Suécia, certifica por este meio que, ao sair da nossa fábrica, as unidades indicadas acima estão em conformidade com as diretivas uniformizadas da UE, os padrões de segurança da UE e os padrões específicos do produto. Este certificado deixa de ser válido se as unidades forem modificadas sem a nossa aprovação.</p>	<p>LT EB atitikties deklaracija</p> <p>Husqvarna AB, 561 82 Huskvarna, Sweden, garantuoja, kad iš gamyklos siunčiami toliau nurodyti įrenginiai atitinka suderintus EB reikalavimus, EB saugos ir konkretaus gamtinio standartus. Pakeltus gaminius be mūsų patvirtinimo, nautraikiamas šio sertifikato galiojimas.</p>
<p>PL Deklaracja zgodności WE</p> <p>Niżej podpisany przedstawiciel firmy Husqvarna AB, 561 82 Huskvarna, Szwecja, niniejszym oświadcza, że podane poniżej wyroby opuszczające fabrykę są zgodne ze zharmonizowanymi normami UE oraz z obowiązującymi w UE przepisami bezpieczeństwa i normami dotyczącymi danego produktu. Modyfikacja wyrobów bez naszej zgody powoduje unieważnienie niniejszego certyfikatu.</p>	<p>LV EK atbilstības deklarācija</p> <p>Uzņēmums Husqvarna AB, 561 82 Huskvarna, Zviedrija, ar parakstu apliecina, ka tālāk minētās vienības, pametot rūpniec, atbilst saskatotajām ES vadlīnijām, ES drošības standartiem un izstrādājuma specifiskajiem standartiem. Šis sertifikāts tiek anulēts, ja šīs vienības tiek modificētas bez mūsu apstiprinājuma.</p>

Produktbezeichnung: Description of the product: Désignation de produit : Productbenaming: Produktbeteckning: Produktbetegelse: Tuotenimike: Nome del prodotto: Designación del producto: Designação do produto: Opis produktu: A termék megnevezése: Označení produktu: Označenie výrobku: Ονομασία προϊόντος: Ime izdelka: Naziv proizvoda: Denumire produs: Описание на продукта: Toote nimetus: Gaminio pavadinimas: Izstrādājuma nosaukums:	Accu-Turbotrimmer Accu Turbotrimmer Coupe-bordures à batterie Accu-Turbotrimmer Accu-Turbotrimmer Accu-turbotrimmer Accu-turbotrimmeri Turbotrimmer a batteria Recortabordes con accu Aparador de relva Accu-Turbotrimmer Podkaszarka akumulatorowa Akkumulátoros damilos fűszegélynyíró Akkumulátorový turbotrimmer Akumulátorový turbotrimmer Επανορθωτικό κουρευτικό πετονιάς Akkumulátorin turbo obrezovalnik Baterijski turbo trimer za travu Turbotrimmer cu baterie Акумуляторен Турботриммер Akuga turbotrimmer Akkumulatoriinė turbo žoliapjovė Turbotrimmeris ar akumulatoru	Schall-Leistungspiegel: Noise level: Niveau sonore : Geluidsniveau: Ljudnivá: Støjniveau: Äänitaso: Livello acustico: Nivel de ruido: Nivel de ruído: Poziom hałas: Zajszint: Hladina hluku: Hladiny hluku: Επίπεδο Θορύβου: Raven zvočne moči: Razina buke: Nivel de zgomot: Ниво на шум: Műratase: Triukšmo lygis: Trokšņa līmenis :	gemessen / garantiert measured / guaranteed mesuré / garanti gemeten / gegarandeerd uppmätt / garanterad målt / garanteret mitattu / taattu misurato / garantito medido / garantizado medido / garantido zmierzony / gwarantowany mért / garantált naměřená / zaručená namerané/zaručené μετρημένο / εγγυημένο izmerjena / zagotovljena mjerena / zajamčena măsurat / garantat измерено / гарантирано mõõdetud / garanteeritud išmatuotas / garantuojamas mēritais / garantētais
--	---	---	---

Art. 9823 83 dB (A) / 88 dB (A)
Art. 9825 82 dB (A) / 86 dB (A)

Produkttyp: Product type: Type de produit : Producttype: Produkttyp: Produkttype: Tuotetyypit: Tipo di prodotto: Tipo del producto: Tipo de produto: Typ produktu:	Terméktípus: Typ produktu: Typ výrobku: Τύπος προϊόντος: Tip izdelka: Tip proizvoda: Tip produs: Тип на продукта: Toote tüüp: Gaminio tipas: Izstrādājuma tips:	Artikelnummer: Article number: Référence : Artikelnummer: Artikelnummer: Artikelnummer: Artikelnummer: Número de artículo: Número de artículo: Número de referéncia:	Numer katalogowy: Cikkszám: Číslo materiálu: Číslo výrobku: Αριθμός προϊόντος: Številka artikla: Broj artikla: Cod articol: Артикулен номер: Artikli number: Gaminio numeris: Preces numurs:
--	---	---	---

EasyCut Li-18/23 R Art. 9823
ComfortCut Li-18/23 R Art. 9825

Anbringningsjaar der CE-Kennzeichnung: Year of CE marking: Année d'aposition du marquage CE: Installatiejaar van de CE-aanduiding: Märkningsår: CE-Mærkningsår: CE-merkin kiinnitysvuosi: Anno di applicazione della certificazione CE: Colocación del distintivo CE: Ano de marcação pela CE: Rok nadania oznakowania CE: CE-jelzés elhelyezésének éve: Rok umístění značky CE: Rok udelenia značky CE:	Έτος ομήτος CE: Leto namestitve CE-oznake: Godina dobivanja CE oznake: Anul de marcare CE: Година на поставяне на CE-маркировка: CE-märgistuse paigaldamise aasta: Metal, kada pažymėta CE-ženklų: CE-märkjuma uzlikšanas gads:
---	--

2013

EU-Richtlinien: EC-Directives: Directives UE : EU-richtlijnen: EU-riktlinjer: EU-direktiver: EU-direktívt: Directive UE: Directivas de la UE: Diretivas UE: Dyrektywy UE: EU-irányelvek: Smernice EU: Smernice EU: Οδηγίες ΕΕ: EU-direktive: Direktive EU:	Directivele EU: ЕС-Директиви: EL-i direktiivid: ES direktivos: ES direktivas:	2006/42/EG 2011/65/EG 2000/14/EG 2014/30/EG
--	---	--

Ladegerät / Battery charger
Art. 9825-00.630.00:
2014/35/EG

Harmonisierte EN-Normen / Harmonised EN: EN ISO 12100 EN 60335-1 EN 50636-2-91	Batterie / Batterie Art. 9839: EN 62133 Ladegerät / Battery charger Art. 9825-00.630.00: EN 60335-1 EN 60335-2-29
---	--

Hinterlegte Dokumentation: GARDENA Technische Dokumentation, M. Kugler 89079 Ulm Deposited Documentation: GARDENA Technical Documentation, M. Kugler 89079 Ulm Documentation déposée: Documentation technique GARDENA, M. Kugler 89079 Ulm	Konformitätsbewertungsverfahren: Nach 2000/14/ EG Art. 14 Anhang VI Conformity Assessment Procedure: according to 2000/14/EC Art.14 Annex VI Procédure d'évaluation de la conformité : Selon 2000/14/CE art. 14 Annexe VI
--	---

Reinhard Pompe
 Vice President

Deutschland / Germany

GARDENA
Manufacturing GmbH
Central Service
Hans-Lorenser-Straße 40
D-89079 Ulm
Produktfragen:
(+49) 731 490-123
Reparaturen:
(+49) 731 490-290
service@gardena.com

Albania

COBALT Sh.p.k.
Rr. Siri Kodra
1000 Tirana

Argentina

Husqvarna Argentina S.A.
Av.del Libertador 5954 –
Piso 11 – Torre B
(C1428ARP) Buenos Aires
Phone: (+54) 11 5194 5000
info.gardena@
ar.husqvarna.com

Armenia

Garden Land Ltd.
61 Tigran Mets
0005 Yerevan

Australia

Husqvarna Australia Pty. Ltd.
Locked Bag 5
Central Coast BC
NSW 2252
Phone: (+61) (0) 2 4352 7400
customer.service@
husqvarna.com.au

Austria / Österreich

Husqvarna Austria GmbH
Industriezone 36
4010 Linz
Tel.: (+43) 732 77 01 01-485
service.gardena@
husqvarnagroup.com

Azerbaijan

Firm Progress
a. Aliyev Str. 26A
1052 Baku

Belgium

Husqvarna België nv/sa
Gardena Division
Rue Egide Van Opthem 111
1180 Uccle / Ukkel
Tel.: (+32) 2 720 92 12
info@gardena.be

Bosnia / Herzegovina

SILK TRADE d.o.o.
Industrijska zona Bukva bb
74260 Tešanj

Brazil

Husqvarna do Brasil Ltda
Av. Francisco Matarazzo,
1400 – 19º andar
São Paulo – SP
CEP: 05001-903
Tel: 0800-112252
marketing.br.husqvarna@
husqvarna.com.br

Bulgaria

AGROLAND България АД
бул. 8 Декември, №13
Офис 5
1700 Студентски град
София
Тел.: (+359) 246669 10
info@agroland.eu

Canada / USA

GARDENA Canada Ltd.
100 Summerlea Road
Brampton, Ontario L6T 4X3
Phone: (+1) 905 792 9330
info@gardenacanada.com

Chile

Maquinarias Agroforestales
Ltda. (Maga Ltda.)
Santiago, Chile
Avda. Chesterton
8355 comuna Las Condes
Phone: (+56) 2 202 4417
Dalton@magla.cl
Zipcode: 7560330

China

Husqvarna (Shanghai)
Management Co., Ltd.
高世华 (上海) 管理有限公司
3F, Bent Square B
No207, Song Hong Rd.,
Chang Ning District,
Shanghai, PRC. 200335
上海市长宁区沁虹路207号明
基广场B座3楼, 邮编: 200335

Colombia

Husqvarna Colombia S.A.
Calle 18 No. 68 D-31, zona
Industrial de Montevideo
Bogotá, Cundinamarca
Tel. 571 2922700 ext. 105
jairo.salazar@
husqvarna.com.co

Costa Rica

Compania Exim
Euroberoamericana S.A.
Los Colegios, Moravia,
20 metros al Sur del Colegio
Saint Francis – San José
Phone: (+506) 297 68 83
exim_euro@racsa.co.cr

Croatia

SILK ADRIA d.o.o.
Josipa Lončara 3
10090 Zagreb
Phone: (+385) 1 3794 580
silk.adria@zg.t-com.hr

Cyprus

Med Marketing
17 Digeni Akrita Ave
P.O. Box 27017
1641 Nicosia

Czech Republic

Husqvarna Česko s.r.o.
Türkova 2319/5b
149 00 Praha 4 – Chodov
Bezplatná infolinka:
800 100 425
servis@cz.husqvarna.com

Denmark

GARDENA DANMARK
Lejrvvej 19, st.
3500 Værløse
Tlf.: (+45) 70264770
husqvarna@husqvarna.dk
www.gardena.com/dk

Dominican Republic

BOSQUESA, S.R.L.
Carretera Santiago Licey
Km. 5 ½
Esquina Copal II,
Santiago
Dominican Republic
Phone: (+809) 736-0333
joserbosquesa@claro.net.do

Ecuador

Husqvarna Ecuador S.A.
Arupos E1-181 y 10 de
Agosto Quito, Pichincha
Tel. (+593) 22800739
francisco.jacom@
husqvarna.com.ec

Estonia

Husqvarna Eesti OÜ
Gardena Division
Valdeku 132
Tallinn
Phone: (+359) 246669 10
info@gardena.ee

Finland

Oy Husqvarna Ab
Gardena Division
Lautatarhankatu 8 B / PL 3
00581 HELSINKI
info@gardena.fi

France

Husqvarna France
9/11 Allée des pierres mayettes
92835 Gennevilliers Cedex
France
http://www.gardena.com/fr
N° AZUR: 0 810 00 78 23
(Prix d'un appel local)

Georgia

ALD Group
Belashvili 8
1159 Tbilisi

Great Britain

Husqvarna UK Ltd
Preston Road
Aycliffe Industrial Park
Newton Aycliffe
County Durham
DL5 6UP
info.gardena@
husqvarna.co.uk

Greece

Γ. ΠΑΠΑΔΟΠΟΥΛΟΣ ΑΕΒΕ
Λεωφ. Αθηνών 92
Αθήνα
T.K. 104 42
ΕΛΚΔΘ
Τηλ. (+30) 210 5193100
info@papadopoulos.com.gr

Hungary

Husqvarna Magyarország Kft.
Ezred u. 1-3
1044 Budapest
Telefon: (+36) 1 251-4161
vevoszolgalat.husqvarna@
husqvarna.hu

Iceland

O. Johnson & Kaaber
Túnguhsali 1
110 Reykjavik
ooj@oik.is

Ireland

Husqvarna UK Ltd
Preston Road
Aycliffe Industrial Park
Newton Aycliffe
County Durham
DL5 6UP
info.gardena@
husqvarna.co.uk

Italy

Husqvarna Italia S.p.A.
Via Santa Vecchia 15
23868 VALMADRERA (LC)
Phone: (+39) 0341.203.111
assistenza.italia@
it.husqvarna.com

Japan

KAJUICHI Co. Ltd.
Sumitomo Realty &
Development Kojimachi
BLDG., 8F
5-1 Nibannyo
Chiyoda-ku
Tokyo 102-0084
Phone: (+81) 33 264 4721
m_ishihara@kaku-ichi.co.jp

Kazakhstan

LAMED LTD.
155/1, Tazhibayevoy Str.
050060 Almaty
IP Schmidt
Abayavenue 3B
110 005 Kostanay

Korea

Kyung Jin Trading CO.,LTD.
107-4, SunDuk Bld.,
YangJae-dong,
Seochoo-gu,
Seoul, (zipcode: 137-891)
Phone: (+82) (0)2 574-6300

Kyrgyzstan

Alye Maki
av. Moladaya Guardir J 3
720014
Bishkek

Latvia

Husqvarna Latvija SIA
Gardena Division
Ulbrokas 19A
LV-1021 Riga
info@gardena.lv

Lithuania

Husqvarna Lietuva
Gardena Division
Atletikos pl. 77C
LT-52104 Kaunas
info@gardena.lt

Luxembourg

Magasins Jules Neuberg
39, rue Jacques Stas
Luxembourg-Gasperich 2549
Case Postale No.12
Luxembourg 2010
Phone: (+352) 40 1401
ap@neuberg.lu

Mexico

AFOSA
Av. Lopez Mateos Sur # 5019
Col. La Calma 45070
Zapopan, Jalisco
Mexico
Phone: (+52) 33 3818-3434
icornejo@afosa.com.mx

Moldova

Convel S.R.L.
290A Muncesti Str.
2002 Chisinau

Netherlands

Husqvarna Nederland B.V.
GARDENA Division
Postbus 50131
1305 AC ALMERE
Phone: (+31) 36 521 00 10
info@gardena.nl

Neth. Antilles

Jonka Enterprises N.V.
Sta. Rosa Weg 196
P.O. Box 8200
Curaçao
Phone: (+599) 9 767 66 55
pgm@jonka.com

New Zealand

Husqvarna New Zealand Ltd.
PO Box 76-437
Manukau City 2241
Phone: (+64) (0) 9 9202410
support.nz@husqvarna.co.nz

Norway

Husqvarna Norge AS
Gardena Division
Trøskeneveien 36
1708 Sarpsborg
Tel: 69 10 47 00
www.gardena.no

Peru

Husqvarna Perú S.A.
Jr. Ramón Cárcamo 710
Lima 1
Tel.: (+51) 1 3320 400 ext. 416
juan.remozgo@
husqvarna.com

Poland

Husqvarna
Poland Spółka z o.o.
ul. Wysockiego 15 b
03-371 Warszawa
Phone: (+48) 22 330 96 00
gardena@husqvarna.com.pl

Portugal

Husqvarna Portugal, SA
Lagoa – Albarraque
2635 – 595 Rio de Mouro
Tel.: (+351) 21 922 85 30
Fax: (+351) 21 922 85 36
info@gardena.pt

Romania

Madex International Srl
Soseaua Odaii 117-123,
RO 013603 Bucuresti, S 1
Phone: (+40) 21 352.76.03
madex@mes.ro

Russia / Россия

ООО „Хускварна“
141400, Московская обл.,
г. Химки,
улица Ленинградская,
владение 39, стр.6
Бизнес Центр
„Химки Бизнес Парк“,
помещение 0802_04
http://www.gardena.ru

Serbia

Domel d.o.o.
Autoput za Novi Sad bb
11273 Belgrade
Phone: (+381) 11 848 88 12
miroslav.jejina@domel.rs

Singapore

Hy-Ray PRIVATE LIMITED
40 Jalin Pemimpin
#02-08 Tat Ann Building
Singapore 577185
Phone: (+65) 6253 2277
shjying@hyray.com.sg

Slovak Republic

Husqvarna Česko s.r.o.
Türkova 2319/5b
149 00 Praha 4 – Chodov
Bezplatná infolinka:
800 154 044
info@sk.husqvarna.com

Slovenia

Husqvarna Austria GmbH
Industriezeile 36
4010 Linz
Tel.: (+43) 732 77 01 01-485
service.gardena@
husqvarnagroup.com

South Africa

Husqvarna
Husqvarna (Pty) Ltd
Postnet Suite 250
Private Bag X6,
Cascades, 3202
South Africa
Phone: (+27) 33 846 9700
info@gardena.co.za

Spain

Husqvarna España S.A.
Calle de Rivas nº10
28052 Madrid
Phone: (+34) 91 708 05 00
atencioncliente@gardena.es

Suriname

Agrofix n.v.
Verlengde Hogestraat #22
Pobox: (+597) 472426
agrofix@sr.net
Pamob: 2006
Paramaribo
Suriname – South America

Sweden

Husqvarna AB
Gardena Division
S-561 82 Huskvarna
info@gardena.se

Switzerland / Schweiz

Husqvarna Schweiz AG
Consumer Products
Industriestrasse 10
5506 Mägenwil
Phone: (+41) (0) 62 887 37 90
info@gardena.ch

Turkey

Dost Bahçe Diş Ticaret
Müesseslik A.Ş.
Yunus Mah. Adil Sok. No:3
İç Kapı No: 1 Kartal
34873 İstanbul
Phone: (+90) 216 38 93 939
info@dobstbahce.com.tr

Ukraine / Україна

ТОВ „Хускарна Україна“
вул. Васильківська, 34,
офіс 204-р
03022, Київ
Тел. (+38) 044 498 39 20
info@gardena.ua

Uruguay

FELISA
Entre Rios 1083 CP 11800
Montevideo – Uruguay
Tel: (+598) 22 03 18 44
info@felisa.com.uy

Venezuela

Corporación Casa y Jardín C.A.
Av. Caroní, Edif. Trezmen, PB.
Colas de Bello Monte.
1050 Caracas.
Tlf: (+58) 212 992 33 22
info@casayjardin.net.ve

9823-20.960.06/0917
© GARDENA
Manufacturing GmbH
D-89070 Ulm
http://www.gardena.com