



Husqvarna[®]

English



Operator Manual

Z 560x / 967 669702-00

Please read the operator manual carefully and make sure you understand the instructions before using the machine.

Gasoline containing a maximum of 10% ethanol (E10) is permitted for use in this machine. The use of gasoline with more than 10% ethanol (E10) will void the product warranty.

115 92 55-26 Rev.A



⚠ WARNING! Failure to follow cautious operating practices can result in dangerous injury to the operator or other persons. The owner must understand these instructions, and must let only approved persons who understand these instructions to operate the mower.

Each person operating the mower must be of sound mind and body and must not be under the influence of mind altering substances.

⚠ WARNING! The rollover protection system's capabilities may be impaired by damage if the mower is overturned or if alteration to the ROPS occurs. If these conditions take place, the total structure **MUST** be replaced.

⚠ WARNING! Engine exhaust, some of its constituents, and certain vehicle components contain or emit chemicals known to the State of California to cause cancer and birth defects or other reproductive harm.

⚠ WARNING! Battery posts, terminals and related accessories contain lead and lead compounds, chemicals known to the State of California to cause cancer and birth defects or other reproductive harm. Clean your hands after handling.

⚠ WARNING! Engine exhaust and certain vehicle components contain or emit chemicals considered to cause cancer, birth defects, or other reproductive system damage. The engine exhaust contains carbon monoxide, which is an odorless, colorless, poisonous gas. Do not use the machine in enclosed spaces.

When this product is worn out and no longer used, return it to the reseller or other party for recycling.

To implement improvements, specifications and designs can be altered without prior notification.

Note that no legal demands can be placed based on the information contained in these instructions.

Use only original parts for repairs. The use of other parts voids the warranty.

Do not modify or install non-standard equipment to the unit without consent from the manufacturer. Modifications to the unit may cause unsafe operations or damage the unit.

CONTENTS

| | | | |
|---|----|-----------------------------------|----|
| INTRODUCTION..... | 4 | OPERATION | 17 |
| Driving and Transport on Public Roads | 4 | Training..... | 17 |
| Towing | 4 | Steering..... | 17 |
| Operating..... | 4 | Operating on Hills..... | 18 |
| SYMBOLS AND DECALS..... | 6 | Moving Machine By Hand..... | 19 |
| SAFETY | 7 | MAINTENANCE..... | 20 |
| Protecting Children..... | 7 | Battery..... | 22 |
| Personal Safety Equipment..... | 8 | Deck Maintenance..... | 23 |
| Slope Operation..... | 8 | Cutting Blades..... | 23 |
| Safe Handling of Gasoline..... | 9 | V-belts..... | 23 |
| Transport..... | 10 | Adjusting the Mower Deck..... | 24 |
| Towing..... | 10 | Deck Lift Spring..... | 25 |
| Spark Arrestor..... | 10 | Neutral Adjustment..... | 25 |
| Rollover Protection System..... | 11 | Park Brake..... | 25 |
| CONTROLS..... | 12 | Tire Pressures..... | 25 |
| Steering Control Levers..... | 13 | Safety System..... | 26 |
| Park Brake..... | 13 | Caster Wheels..... | 26 |
| Throttle Control..... | 13 | LUBRICATION..... | 27 |
| Ignition Switch..... | 14 | Engine oil..... | 28 |
| Choke Control..... | 14 | Wheel and Deck Zerks..... | 28 |
| Blade Switch..... | 14 | Transaxle Fluid Change..... | 28 |
| Service Meter..... | 14 | TROUBLESHOOTING..... | 30 |
| Fuel Gauges..... | 14 | STORAGE..... | 31 |
| Fuses..... | 14 | SCHEMATIC..... | 32 |
| Fuel Shut Off Valve..... | 15 | CONFORMITY..... | 33 |
| Seat Adjustment..... | 15 | EC Declaration Of Conformity..... | 33 |
| Cutting Height..... | 15 | TECHNICAL DATA..... | 34 |
| Fuel Tanks..... | 15 | SERVICE JOURNAL..... | 37 |
| Tracking..... | 16 | | |

INTRODUCTION

Congratulations

Thank you for purchasing a Husqvarna ride-on mower. This machine is built for superior efficiency to rapidly mow primarily large areas. A control panel that the operator can easily access and a hydrostatic transmission regulated by steering controls each contribute to the machine's performance.

This manual is a valuable document. Read the contents carefully before using or servicing the machine. The following of instructions (use, service, maintenance) by all who operate this machine is important for the safety of the operator and others. It can also largely increase the life span of the machine and increase its resale value.

If you sell your machine, be sure to give the operator manual to the new owner.

The last chapter of this operator manual supplies a Service Journal. Make sure that service and repair work are documented. A correctly kept service journal reduces service costs for the maintenance and affects the machine's resale value. Please contact your dealer for more information. Take the operator manual along when the machine is taken to your dealer for service.

General

In this operator manual, left and right, rearward and forward are used in relation to the machine's usual driving direction.

Continuous dedication to make our products better requires that specifications and design are subject to change without notice.

Driving and Transport on Public Roads

Check applicable road traffic regulations before transporting on public roads. If the machine is transported, you must always use approved fastening equipment and make sure that the machine is correctly attached. DO NOT operate this machine on public roadways.

Towing

If machine is equipped with a tow hitch, use much more care when towing. Do not let children or others in or on the towed equipment. Make wide turns to avoid jack-knifing. Travel slowly and leave more distance to stop.

Do not tow on sloped ground. The weight of the towed equipment can cause loss of traction and loss of control.

Obey the manufacturer's recommendation for weight limits for towed equipment. Do not tow near ditches, canals, and other dangerous areas.

Operating

This machine is constructed only for mowing grass on lawns and even ground without obstacles such as stones, tree stumps, etc. The machine can also be used for other tasks when equipped with special accessories supplied by the manufacturer. Operating instructions for the accessories are supplied with delivery. All other types of uses are incorrect. The manufacturer's directions concerning operation, maintenance, and repairs must be carefully followed.

Lawn mowers and all power equipment, can be potentially dangerous if used incorrectly. Safety requires good judgment, careful use in accordance with these instructions and common sense.

The machine must only be operated, maintained, and repaired by persons who know the machine's special qualities and who are also knowledgeable about the safety instructions. Use only approved repair parts to maintain this machine.

Accident prevention regulations, other general safety regulations, occupational safety rules, and traffic regulations must be followed without fail.

Unauthorized modifications to the design of the machine can absolve the manufacturer from liability for resulting personal injury or damage to property.

INTRODUCTION

Good Service

Husqvarna's products are sold throughout the world and only in specialized retail stores with complete service. This ensures that you as a customer receive only the best support and service. Before the product is delivered, the machine has, for example, been inspected and adjusted by your retailer. See the certificate in the Service Journal in this operator manual.

When you need spare parts or support in service questions, warranty issues, etc., consult the following professional:

| | | |
|---|--------|--------------|
| | | |
| This manual belongs to the machine with the manufacturing number: | Engine | Transmission |

Manufacturing Number

The machine's manufacturing number can be found on the printed plate affixed to the engine compartment.

Stated on the plate, from the top are:

- The machine's type designation (I.D.).
- The manufacturer's type number (Model).
- The machine's serial number (Serial no.)

Please have the type designation and serial number available when ordering spare parts.

The engine's manufacturing number is stamped on one of the valve covers.

The plate states:

- The engine's model.
- The engine's type.
- Code

Please have these available when ordering spare parts.

The wheel motors and hydrostatic pumps have a barcode decal affixed at the rear.

SYMBOLS AND DECALS

These symbols are found on the machine and in the operator manual. Study them carefully until you know what they mean.

IMPORTANT INFORMATION Xxxx xxxxxx
xxxxx xxxx xxxxxxxxxxxx xxxxxx xxxxxxxxxxxx.





Used in this publication to tell the reader of a risk of material damage, particularly if the reader neglects to obey the instructions in the manual. Used also when there is a possibility for misuse or misassembly.



 **WARNING!** Xxxx xxxxxx xxxxxx xxxxx
xxxxxxxxxxx xxxxxx xxxxxxxxxxxx.



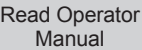
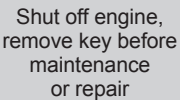
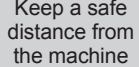
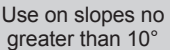

Used in this publication to tell the reader of a risk of personal injury or death, particularly if the reader neglects to obey the instructions in the manual.

| | | | | | | |
|--|---|---|---|---|---|---|
|  |  |  |  |  |  |  |
| Reverse | Neutral | Fast | Slow | Choke | Fuel | Park Brake |

| | | | | | |
|--|---|---|---|---|--|
|  |  |  |  |  |  |
| Danger | Use protective glasses | Use protective gloves | Wear hearing protection | Do not stand here | Noise emissions to the surroundings in accordance with the European Union's directive. The machine's emission is stated in the chapter TECHNICAL DATA and on decals. |

| | | | |
|--|---|---|---|
|  |  |  |  |
| Warning! Do not touch parts | Warning! Do not use without deflector or grass catcher | Warning! Use caution when lifting the cover | Warning! Battery acid is corrosive, explosive and flammable |

| | | | | |
|--|--|---|---|---|
|  |  |  |  |  |
| Read Operator Manual | Shut off engine, remove key before maintenance or repair | Keep a safe distance from the machine | Use on slopes no greater than 10° | No passengers |

| | | | | |
|--|---|---|---|---|
|  |  |  |  |  |
| Whole body exposure to thrown objects | Severing of fingers and toes | Do not open or remove safety shields with engine running | Careful backing up, watch for other people | Careful going forward, watch for other people |

SAFETY

Safety Instructions

These instructions are for your safety. Read them carefully.

⚠ WARNING! THIS CUTTING MACHINE CAN AMPUTATE HANDS AND FEET AND THROW OBJECTS. FAILURE TO OBEY THE FOLLOWING SAFETY INSTRUCTIONS COULD RESULT IN SERIOUS INJURY OR DEATH.

⚠ WARNING! CHILDREN CAN BE SERIOUSLY INJURED OR KILLED BY THIS EQUIPMENT. Carefully read and obey all the safety instruction that follow.

IMPORTANT INFORMATION The American Academy of Pediatrics recommends that children be a minimum of 16 years of age before operating a riding lawn mower.

Protecting Children

Tragic accidents can occur if the operator is not alert to the presence of children. Children are frequently attracted to the machine and the mowing activity. **Do not** think that children will stay where you last saw them.

- Keep children out of the mowing area and in the watchful care of a responsible adult **other than** the operator.



- Be alert and turn machine off if a child enters the area.
- Before and while backing, look behind and down for small children.

- Do not carry children, even with the blades shut off. They can fall off and be seriously injured or interfere with safe machine operation. Children who have been given rides in the past can suddenly come into the mowing area to ride again and be run over or backed over by the machine.



- Do not let children to operate the machine.
- Use extreme care when going near blind corners, shrubs, trees, or other objects that can block your view of a child.

General Operation

- Read, understand, and obey all instructions on the machine and in the manual before starting.
- It is recommended that someone knows that you are mowing and can give aid if there is an injury or accident.

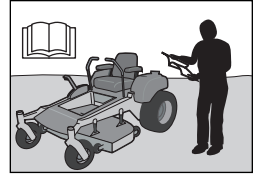

- Those who operate, maintain, and/or service this machine must first read and understand this Operator Manual. Local laws can regulate the age of the user. The owner is responsible for training the users of this equipment.
- The owner and operator of this equipment can prevent accidents and is responsible for accidents or injuries occurring to themselves, other persons and/or property.
- Do not put hands or feet near rotating parts or under the machine. Keep away from the discharge opening at all times.
- Only let responsible adults, who are familiar with the instructions, to operate the machine.

- Clean the area of objects such as rocks, toys, wire, etc., which could be picked up and thrown by the blades.

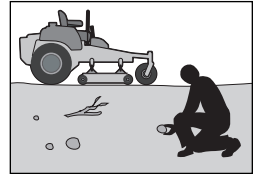

- Be sure the area is has no bystanders before operating. Stop machine if someone enters the area.
- Do not mow in reverse unless fully necessary. Always look down and behind before and while backing.
- Do not point discharged material toward someone. Avoid discharging material against a wall or obstruction. Material can ricochet back toward the operator. Stop the blades when going across gravel surfaces.
- Do not operate machine without the full grass catcher, discharge guard, or other safety devices in place and working.
- Slow down before turning.
- Always turn off blades, move the steering control lever out to the park brake position, stop engine and remove keys before dismounting.
- Do not carry passengers. The machine is only intended for use by one person.
- Operate the machine only in daylight or good artificial light.

SAFETY

- Disengage blades when not mowing. Shut off engine and wait for all parts to come to a full stop before cleaning the machine, removing the grass catcher or unlogging the discharge guard.
- Do not operate the machine while under the influence of alcohol or drugs.
- Look for traffic when operating near or going across roadways.
- Use more care when loading or removing the machine into a trailer or truck.
- Always wear eye protection when operating machine.

WARNING! When using the machine, approved personal protective equipment must be used. Personal protective equipment cannot remove the risk of injury but it will reduce the degree of injury if an accident does occur. Speak to your retailer for aid in choosing the right equipment.

- Wear correct Personal Protective Equipment (PPE) while operating this machine, including (at a minimum) sturdy footwear, eye protection, and hearing protection. Do not mow in shorts and/or footwear with open toes.
- Data shows that operators age 60 years and above are involved in a large percentage of riding mower-related injuries. These operators must evaluate if they can safely operate the riding mower sufficiently to protect themselves and others from serious injury.
- Obey the manufacturer's recommendation for wheel weights or counterweights.
- Keep machine free of grass, leaves or other debris buildup which can touch hot exhaust or engine parts and burn. Do not let the mower deck plow leaves or other debris that can cause a buildup to occur. Clean oil or fuel spillage before operating or storing the machine.
- Let machine cool before storage.

Personal Safety Equipment

- Make sure that first aid equipment is near at hand when using the machine.
- Do not use the machine when barefoot.
- Always wear protective shoes or boots. Steel toe caps are recommended.



- Always wear approved protective glasses or a full visor when assembling or driving.
- Always wear gloves when handling the blades.
- Do not wear loose clothing that can become caught in moving parts.
- Use ear protectors to avoid damage to hearing.

Slope Operation

Slopes are a major cause related to loss of control and tip-over accidents, which can result in severe injury or death. Operation on slopes requires more care. If you cannot back up the slope or if you feel uneasy on it, do not mow it.

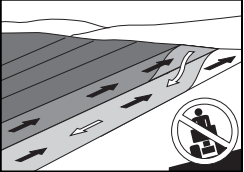
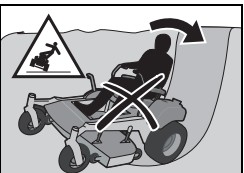
- Mow up and down slopes (10 degrees maximum), not across. 
- Look for holes, ruts, bumps, rocks, or other hidden objects. Uneven terrain could overturn the machine. Tall grass can hide obstacles.
- Select a low ground speed so it will not be necessary to stop while on the slope.
- Do not mow on wet grass. Tires can lose traction.
- Avoid starting, stopping, or turning on a slope. If the tires lose traction, disengage the blades and continue slowly straight down the slope.
- Move slowly and gradually on slopes. Do not make sudden changes in speed or direction, which could cause machine to roll over. 
- Use more care while operating machine with grass catchers or other attachments; the stability of the machine can be effected.
- Do not use on steep slopes.
- Do not try to stabilize the machine by putting a foot on the ground.
- Do not mow near drop-offs, ditches, or embankments. The machine could suddenly roll over if a wheel is over the edge or the edge caves in.

WARNING! Do not drive up or down hills with slopes greater than 10 degrees. Do not drive across slopes.

SAFETY

Safe Handling of Gasoline

To avoid personal injury or damage to property, use care in handling gasoline. Gasoline is very flammable and the vapors are explosive.

⚠ WARNING! The engine and the exhaust system become very hot during operation. There is a risk for burns if touched. Let engine and exhaust system to cool before refueling.

- Do not fuel the machine indoors.
- Extinguish all cigarettes, cigars, pipes, and other sources of ignition.
- Use only approved gasoline containers.
- Do not remove gas cap or add fuel with the engine running. Let engine cool before refueling.
- Do not keep the machine or fuel container where there is an open flame, spark or pilot light such as on a water heater or other appliance.
- Before you start refueling, keep the risk of static electricity to a minimum by touching a metal surface.
- Do not fill containers in a vehicle or on a truck or trailer bed with plastic liner. Always put containers on the ground away from the vehicle when filling.
- Do not put too much fuel in the tank. Replace gas cap and tighten securely.
- Remove gas-powered equipment from the truck or trailer and refuel it on the ground. If this is not possible, refuel such equipment with a portable container, rather than from a gasoline dispenser nozzle.
- Keep the nozzle in contact with the rim of the fuel tank or container opening at all times until fueling is complete. Do not use a nozzle lock-open device.
- If fuel is spilled on clothing, change clothing immediately.
- Do not start the engine near spilled fuel.
- Do not use gasoline as a cleaning agent.
- If leaks occur in fuel system, the engine must not be started until problem has been resolved.
- Check the fuel level before each use and leave space for the fuel to expand, because the heat from the engine and the sun can otherwise cause the fuel to expand and overflow.



General Maintenance

- Do not use the machine indoors or in spaces lacking correct ventilation. The exhaust fumes contain carbon monoxide, an odorless and poisonous lethal gas.
- Make sure that the equipment is in good condition and that all nuts and bolts, especially those fastening the blade attachments, are correctly tightened and torqued.

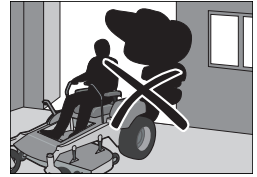

CAUTION! Use protective glasses for maintenance work.

- Maintain or replace safety and instruction labels as necessary.
 - Do not interfere with the intended operation of or reduce the protection given by a safety device. Check their operation regularly. DO NOT operate a machine with a safety device that does not operate correctly.
 - Check grass catcher components and the discharge guard frequently and replace with manufacturer's recommended parts when necessary.
- ⚠ WARNING!** The engine must not be started when the driver's floor plate or protective plates for the mower deck's drive belt is removed.
- Do not change the settings of engine controllers and avoid running the engine at overly high engine speeds. If you run the engine too fast, machine components could be damaged.
 - To reduce the risk of fire, keep machine free of grass, leaves or other debris buildup. Clean oil or fuel spills and remove fuel-soaked debris. Let machine cool before storing.
 - Stop to do an inspection of the equipment if you run over or into anything. If necessary, make repairs before starting.
 - Do not make adjustments or repairs with the engine running.
 - The blades are sharp and can cause cuts and gashes. Wrap blades or use protective gloves when handling them.
 - Check the park brake's operation regularly. Adjust and service as necessary.
 - Do not work with the starter circuit if there is spilled fuel.

SAFETY

- Make sure that the fuel filler cap is mounted tightly and no flammable substances are kept in an open vessel.
- Sparking can occur when working with the battery and the heavy cables of the starter circuit. This can cause battery explosion, fire or eye injury. Sparking will not occur after the grounding cable (normally negative, black) is removed from the battery.
- Disconnect the grounding cable from the battery first and reconnect it last.
- Do not make a bridge short circuit across the starter relay to run the starter.
- Be very careful when handling battery acid. Acid on skin can cause serious corrosive burns. If you spill battery acid on your skin, rinse immediately with water.
- Acid in the eyes can cause blindness, contact a doctor immediately.

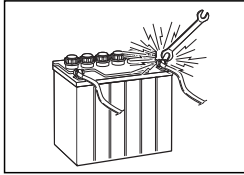

- Be careful when servicing the battery. Explosive gases form in the battery. Do not do maintenance on the battery when smoking or near open flames or sparks. The battery can explode and cause serious injury or damage.
- The machine is tested and approved only with the equipment originally supplied or recommended by the manufacturer. Only use approved repair parts for the machine.
- The mulch blades must only be used in familiar areas when higher quality mowing is necessary.
- Regularly clean the deck and the underside of the deck. Avoid spraying engine and electrical components with water.

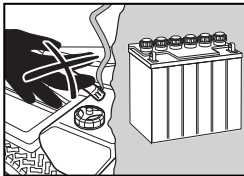

Transport

- The machine is heavy and can cause serious crushing injuries. Be more careful when it is loaded on or removed from a vehicle or trailer.
- Use full width ramps for loading machine into a trailer or truck.
- The two front and rear tie down straps must be used and directed down and out from the machine.

- Check and abide by local traffic regulations before transporting the machine on roads.
- Use an approved trailer to transport the machine. Turn off the fuel supply. Fasten the machine down with approved devices such as bands, chains or straps.
- Do not tow this machine, it can cause damage to the drive system.
- Do not tow trailers, etc. with this mower. They can jackknife or overturn, causing damage to the mower and possible serious injury to the operator.
- Load the unit onto truck or trailer by driving up ramps of sufficient strength using a slow speed. Do not lift! The machine is not intended to be lifted by hand.
- When loading or removing this machine, do not use more than the maximum recommended operation angle of 10 degrees.

WARNING! Use extreme care when loading the machine into a truck or trailer using ramps. There is the possibility of serious injury or death if the machine falls off the ramps.

IMPORTANT INFORMATION The park brake is not sufficient to lock the machine in place during transport. Make sure the machine is correctly fastened to the transport vehicle. Always reverse the machine onto the transport vehicle to avoid tipping it over.

Towing

If machine is equipped with a tow hitch, use much more caution when towing. Do not let children or others in or on towed equipment.

Make wide turns to avoid jack-knifing. Travel slowly and leave more distance to stop. Do not tow on sloped ground. The weight of the towed equipment may cause loss of traction and loss of control.

Follow the manufacturer's recommendation for weight limits for towed equipment. Do not tow near ditches, canals, and other hazards.

Spark Arrestor

This mower is equipped with an internal combustion engine and must not be used on or near unimproved forested, bush covered or grassy lands unless the engine's system is equipped with a spark arrestor meeting applicable local or state laws. Federal laws apply on federal lands. If a spark arrestor is used, it must be maintained in good working order by the operator.

A spark arrestor for the muffler is available through your authorized Husqvarna dealer.

SAFETY

Rollover Protection System

The Rollover Protection System (ROPS) increases the basic weight of the unit by 73 lbs.

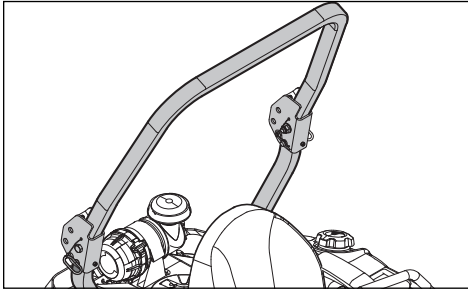

- Do not use ROPS as a lifting, attaching or anchoring point.
- Do not use ROPS for wrecking or towing.
- Do not exceed Max GVW: 2200 lbs.
- Read the operator manual before use.
- Securely fasten the seat belt if the unit has a ROPS.
- Be certain the seat belt operates correctly and can be released quickly in the event of an emergency.
- Keep folding ROPS in the raised and locked position and use the seat belt when operating the machine.
- Lower a folding ROPS temporarily only when absolutely necessary. Do NOT wear the seat belt when the ROPS is folded down.
- Check carefully for overhead clearance (i.e. before driving under trees, electrical wires, through doorways) while loading into a truck or trailer.
- Keep the ROPS in safe operating condition by periodically inspecting for damage and keeping all mounting fasteners tight. Check all bolts, including on the seat belt, for correct torque before each use.
- Check the ROPS structure for damage before each use. If any part of the ROPS is damaged, the entire ROPS must be replaced.
- DO NOT remove the ROPS.
- Where possible, avoid operating the unit near ditches, embankments and holes.

- Reduce speed when turning, crossing slopes and on rough, slick or muddy surfaces. Stay off slopes too steep for safe operation.
- Watch where you are going, especially at row ends, on roads and around trees.
- Do not permit others to ride.
- Operate mower smoothly, no jerky turns, starts or stops.
- When mower is stopped, engage park brake securely.
- ROPS bar is NOT intended for use in sub zero temperatures.

⚠ WARNING! Please note that there is NO roll over protection when the ROPS is folded down.

CONTROLS

This operator manual describes the Husqvarna Zero Turn Rider. The rider is fitted with a four-stroke overhead valve engine.

Transmission from the engine is made via belt-driven hydraulic pumps. Using the left and right steering controls, the flow is regulated and thereby the direction and speed.

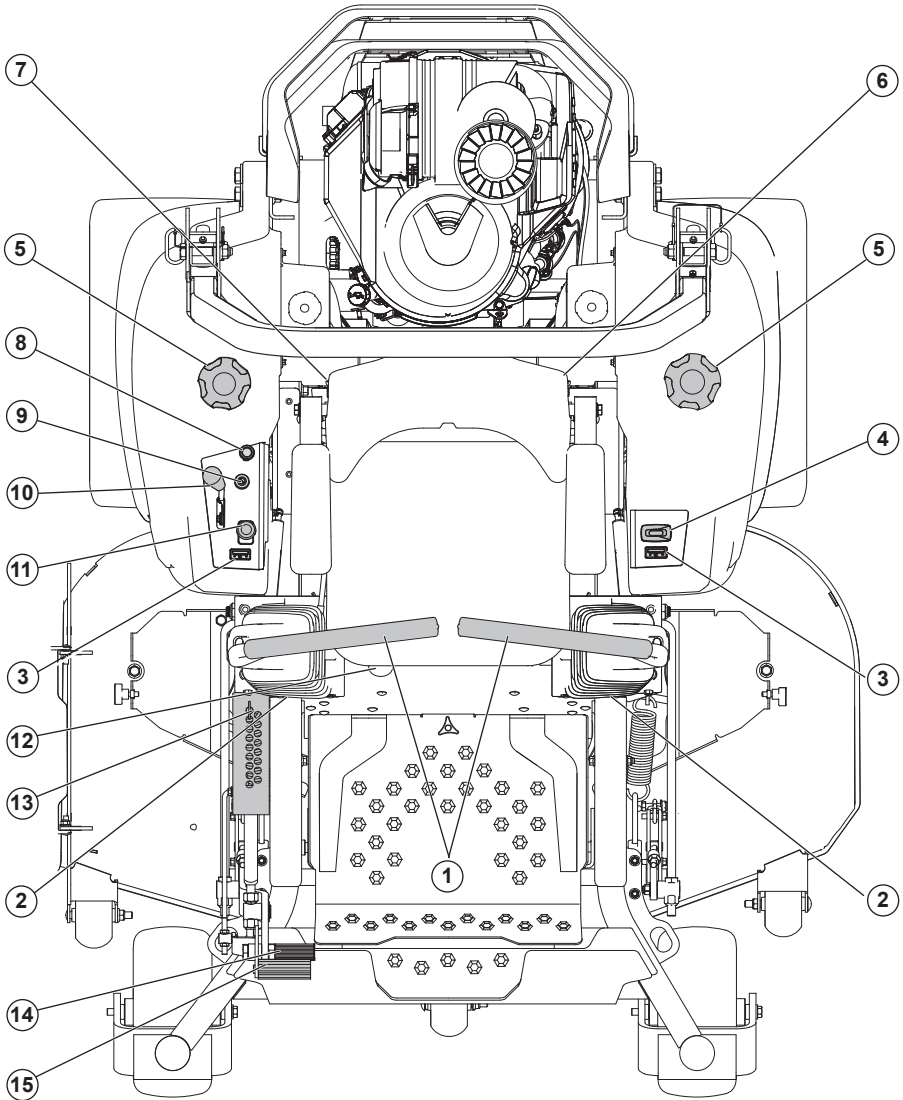

1. Steering / park brake controls

6. Fuses

11. Blade switch

2. Tracking controls

7. Fuel tank selector

12. Seat adjustment lever

3. Fuel gauges

8. Choke control

13. Deck height pin

4. Service meter

9. Ignition switch

14. Deck lift pedal

5. Fuel tank caps

10. Throttle control

15. Deck release pedal

CONTROLS

Steering Control Levers

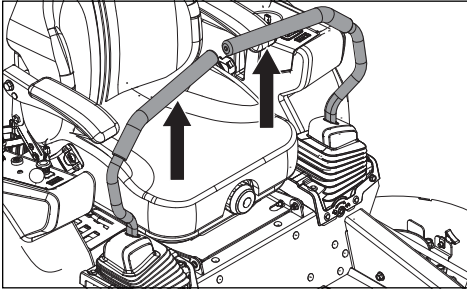

The machine's speed and direction are continuously variable using the two steering controls. The steering controls can be moved forward or backward about a neutral position. There is a neutral position, which is locked if the steering controls are moved out.

When the two controls are in the neutral position (N), the machine stands still. Equally moving the two controls forward or backward moves the machine in a straight line forward or backward.

For example, to turn right while moving forward, move the right control towards the neutral position. The rotation of the right wheel is reduced and the machine turns to the right.

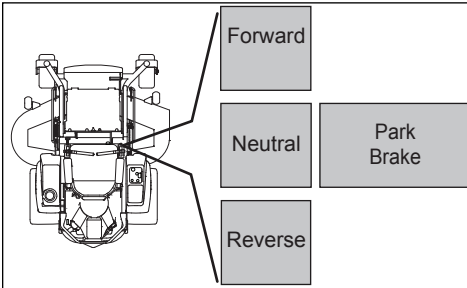

Zero turn can be achieved by moving one control backward (behind the neutral position) and carefully moving the other steering control forward from its neutral position. The rotation direction when zero turning is determined by which steering control is moved backward behind the neutral position. If the left steering control is pulled backward, the machine turns to the left. Use more care when using this maneuver.

If the steering controls are in uneven positions when standing still or do not fit in the slots for moving the controls out, they can be adjusted.

⚠ WARNING! The machine can turn very rapidly if one steering control is moved much further forward than the other.

Park Brake

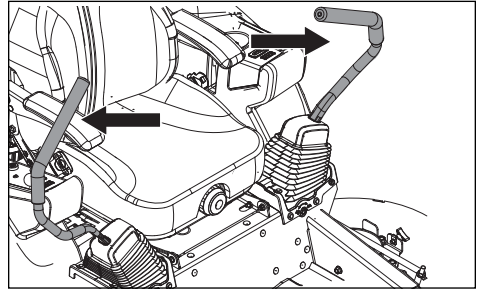

The park brake is integrated with the steering control levers. Move the two levers out from the neutral position to engage the park brake.

To release the park brake, pull the two steering control levers inwards to the neutral position at the same time. Do not operate the unit without the two levers being inwards out of the engaged position or machine components could be damaged.

IMPORTANT INFORMATION Failure to bring the steering / park brake controls inwards at the same time will cause the unit's safety system to shut the unit down.

Throttle Control

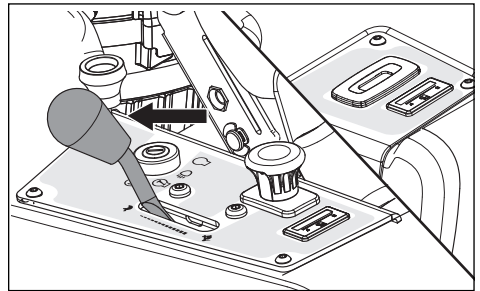

The throttle control regulates the engine speed and the rate of rotation of the blades, assuming the blade switch is pulled out.

To increase or decrease the engine speed, the control is moved forward or back respectively.

Avoid idling the engine for long periods, as there is a risk of fouling the spark plugs. **USE FULL THROTTLE WHEN MOWING**, for best mower performance and battery charging.

CONTROLS

Ignition Switch

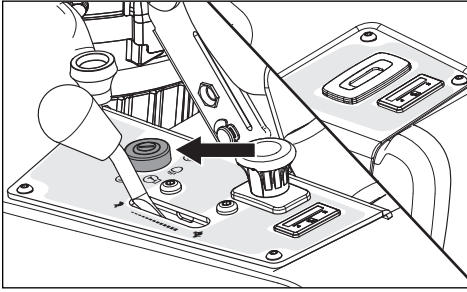

The ignition switch is used to start and stop the engine. On models equipped with headlights, turn the key clockwise to ACCESSORY for headlight use.

Choke Control

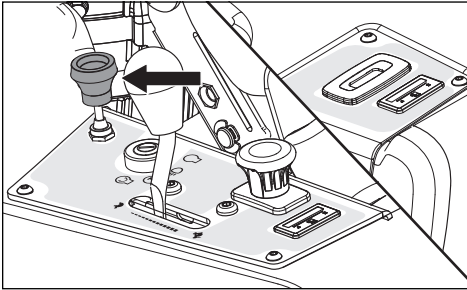

The choke control is used for cold starts to provide the engine with a richer fuel mixture. For cold starts, pull the control up.

Blade Switch

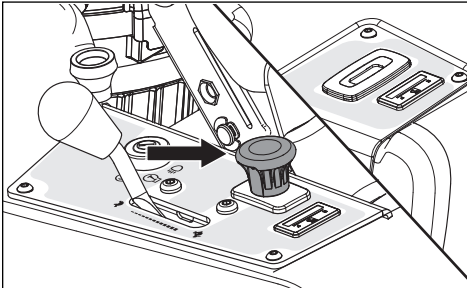

To engage the mower deck, pull the knob out; mower blades are disengaged when the knob is pressed down.

Service Meter

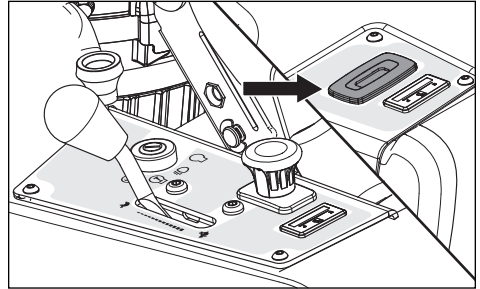

The service meter is located on the left hand control panel and shows the total operating time with the blades engaged.

After every 50 hours of operation, an oil can icon will appear and stay on for two hours, before an automatic reset occurs. To manually reset the meter, turn the key off and on five times at one second intervals. To service the engine and mower, see the Service Journal of this manual.

Fuel Gauges

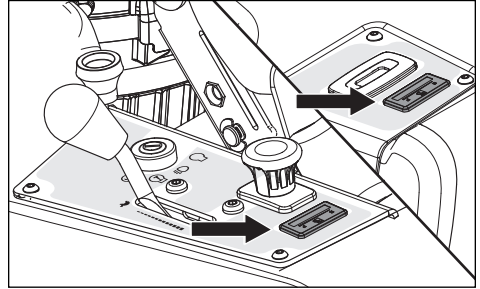

Fuel gauges for each fuel tank are located the right and left control panels.

Fuses

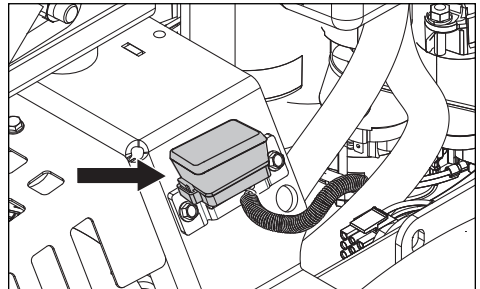

Fuses are located on the left hand side of the machine and are accessed by tilting the seat forward. Fuses are flat pin fuses type as used in automobiles. The 20 A is the primary fuse. The 7.5 A is for the mower deck coupling. The 10 A is for accessories.

CONTROLS

Fuel Shut Off Valve

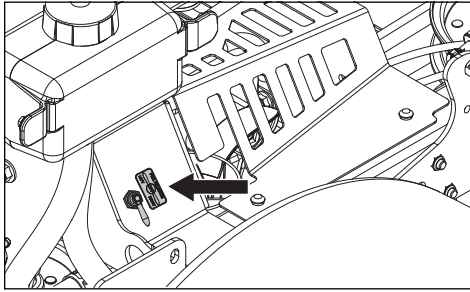

The fuel shut off valve is located at the right rear of the seat. The valve has three positions: right tank, left tank and OFF.

Seat Adjustment

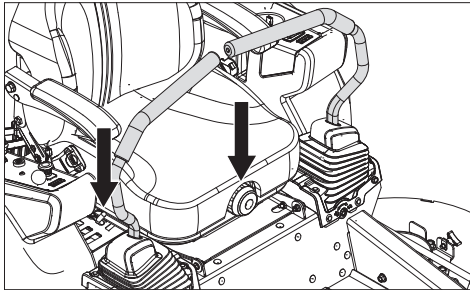

The seat can be adjusted lengthways with the lever located at the right hand side of the seat. When making adjustments the lever is moved upward.

Adjustments may be made to seat suspension by turning the center knob.

IMPORTANT INFORMATION Seat must not be adjusted while unit is in motion.

Seat Release

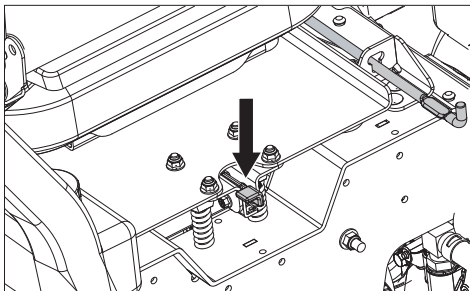

The seat can be rotated forward to access the mower battery and hydro gears. Pull up on the latch lever to release the seat. Raise the seat until the rod engages.

Cutting Height

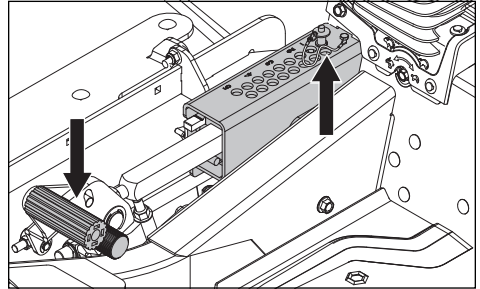

The cutting height pedals release the deck lift and set the desired deck height. Apply pressure to the lift pedal (lower) and rotate foot to also apply pressure to the release pedal (upper), unlocking the deck lift.

For transport, push the lift pedal forward until the deck lift latches in the transport (highest) position.

The cutting height can be set from 25.4 mm - 127 mm. To set the deck cutting height, press the button on the top of the height pin to remove it. Slip the height pin into the hole for the desired cutting height.

Release deck height control pedal by pushing it forward.

IMPORTANT INFORMATION Always raise the deck to the highest position for transport.

Fuel Tanks

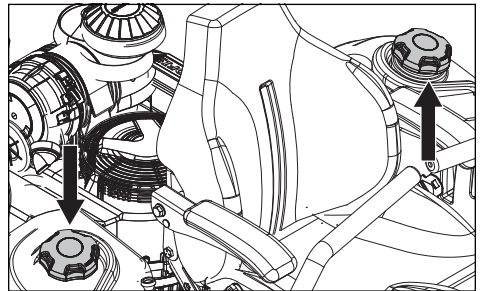

Read the safety instructions before refueling. The capacity for each tank is six gallons (22.7 liters).

Regularly check the gas cap gasket for damage and keep the cap properly tightened.

WARNING! Fill to bottom of filler neck. Do not overfill. Wipe off spilled oil or fuel. Do not store, spill or use gasoline near an open flame.

The engine will run on a minimum of 87-octane unleaded gasoline (no oil mix). Environmentally adapted alkylate gasoline can be used. See

CONTROLS

Technical Data concerning ethanol fuel. Methanol fuel is not allowed. Do not use E85 alcohol based fuel. Damage to the engine and components may occur.

When operating in temperatures below 0°C, use fresh, clean winter grade gasoline to help insure good cold weather starting.

IMPORTANT INFORMATION Experience indicates that alcohol blended fuels (called gasohol, ethanol or methanol) can attract moisture which leads to separation and formation of acids during storage. Acidic gas can damage the fuel system of an engine while in storage. To avoid engine problems, the fuel system must be emptied before storage of 30 days or longer. Drain the gas tank, start the engine and let it run until the fuel lines and carburetor are empty. Use fresh fuel the next season. See **Storage** for more information. Do not use engine or carburetor cleaners in the fuel tank or permanent damage may occur.

WARNING! Gasoline is highly flammable. Observe caution and fill the tank outdoors (see the safety section).

WARNING! The engine and the exhaust system, become very hot during operation. There is a risk for burns if touched. Let engine and exhaust system to cool before refueling.

2. For preliminary tracking adjustment, move unit to an open, unobstructed area such as an empty parking lot or open field.
3. Back the bolts out until flush with nut.
4. Test operate unit by driving it at full throttle and the full forward position on the two steering control levers. Gradually turn in the tracking bolt on the right hand side until the unit noticeably starts drifting right.
5. Drive forward at full throttle with the two steering control levers in the full forward position. Gradually turn in the left hand tracking bolt until unit tracks straight.

Tracking

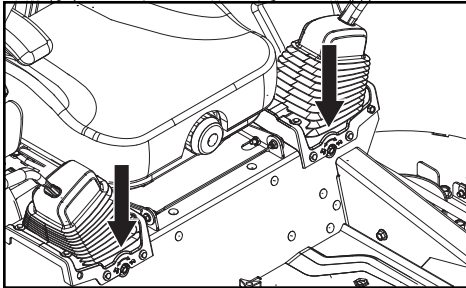

If the mower is not tracking straight, check the air pressure in the two rear tires. Recommended air pressure for the rear tires is 15 psi (1 bar).

1. Tracking adjustments are made using the tracking bolts. The bolts act as limiting devices for the motion control levers when in the full-forward position.

OPERATION

Read the *Safety* section and following pages, if you are unfamiliar with the machine.

Training

Due to unique steering capabilities, zero turn mowers are far more maneuverable than typical riding mowers.

Review this section fully before trying to move the mower under its own power. When first operating the mower or until becoming comfortable with controls, use a reduced throttle speed and reduced ground speed. DO NOT move control levers to the furthest forward or reverse positions during initial operation.

First time users must become familiar with the mower's movement on a hard surface, such as concrete or blacktop BEFORE trying to operate on turf. Until the operator becomes comfortable with the mower controls and zero turn, overly aggressive maneuvers can damage turf.

Steering

To move forward and rearward

The direction and speed of the mower's movements are effected by the movement of the control lever(s) on each side of mower. The left lever controls the left wheel. The right lever controls the right wheel.

First time users must push the mower (see ***Moving Machine By Hand*** in the *Operation* section) to an open, flat area without other persons, vehicles or obstacles nearby. To move the unit under its own power, the operator must sit in the seat and start the engine (see ***Before Starting*** in the *Operation* section). Adjust the engine speed to idle but do not engage the blades. Pull control levers inward. As long as the control levers have not been moved forward or rearwards, the mower will not move.

Slowly move the two control levers forward slightly. This will let the mower start moving forward in a straight line. Pull the control levers back to the neutral position and stop the mower from moving.

Pull back slightly on control levers, allowing the mower to move rearwards. Push the control levers forward to the neutral position to stop the mower from moving.

To turn to the right

While moving in a forward direction, pull the right lever back towards the neutral position while maintaining the position of the left lever, this will slow the rotation of the right wheel and cause the machine to turn in that direction.

To turn to the left

While moving in a forward direction pull the left lever back towards the neutral position while maintaining the position of the right lever, this will slow the rotation of the left wheel and cause the machine to turn in that direction.

To zero turn

While moving in a forward direction, first pull the two control levers back until the mower stops or slows dramatically.

Then by alternating one lever slightly to the forward position and the other in the reverse position, complete the turn.



WARNING! Make sure the work area is free of stones and other objects that could be thrown by the rotating blades.

Roll Bar

Operate the unit with the roll bar in the raised and locked position and use the seat belt. There is no rollover protection when the roll bar is down. If it is necessary to lower roll bar, do not wear the seat belt. Raise the roll bar as soon as clearance permits.



WARNING! The seat belt must be used when the roll bar is in upright position.

Before Starting



WARNING! Make sure the work area is free from of stones and other objects that could be thrown by the rotating blades.

1. Read the sections on *Safety* and *Controls* before starting the machine.
2. Perform the daily maintenance before starting (see ***Maintenance Schedule*** in the *Maintenance* section).
3. Check that there is sufficient fuel in the fuel tank.
4. Adjust the seat to the desired position.

The following conditions must be fulfilled before the engine can be started:

- The blade switch must be pressed down into the disengaged position.
- The two steering / park brake controls must be in the locked (outer) position.

Starting the Engine

1. Sit on the seat.
2. Raise the mower deck to the transport position by pushing the lift pedal forward.

OPERATION

3. Disengage the mower blades by pressing the blade switch down.
4. Move the steering / park brake controls to the locked (outer) position.
5. Move throttle control to the middle position. If the engine is cold, pull the choke control up.

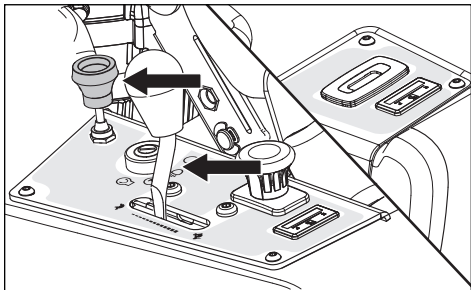

6. Set the fuel tank valve to the desired tank.
7. Set the deck height pin in the desired position.

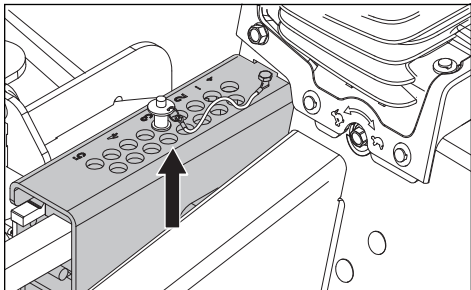

8. Press in and turn the ignition key to the start position.

IMPORTANT INFORMATION Do not run the starter for more than five seconds each time. If the engine does not start, wait approximately ten seconds before retrying.

9. When the engine starts, immediately release the ignition key back to the run position. Slowly push in the choke control knob, if it was used to start a cold engine.
10. Set the engine speed with the throttle. Allow the engine to run at a moderate speed, approximately mid throttle, for a short time before use. **USE FULL THROTTLE WHEN MOWING** (no choke).

Running

1. Release the park brake by pulling the steering / park brake controls in to the neutral position at the same time.

NOTE: The mower is equipped with an operator presence system. If the operator

tries to leave the seat with the engine running, without first engaging the park brake, the engine will shut off.

2. Release deck height control by pushing the pedal forward to lower the deck to selected setting.
3. Move throttle control to full throttle.
4. Engage the mower deck by pulling the blade switch up.

WARNING! Make sure that no one is near mower when engaging blade switch.

5. Pull control levers inward and slowly move the two control levers slightly forward to move forward in a straight line.

Stopping the Engine

1. Move the throttle to the minimum position (tortoise symbol).
2. Move the steering / park brake controls at the same time out to the park brake position.
3. Release the mower deck by pressing the blade switch down.
4. Raise the mower deck by pressing the foot pedals forward to the transport position. If the engine has been worked hard, allow it to idle at least sixty seconds to attain a normal operating temperature before stopping. To prevent fouling the spark plugs, avoid idling the engine for longer periods.
5. Turn the ignition key to the stop position and remove the key. Always remove the key when leaving the mower to prevent unauthorized use.

IMPORTANT INFORMATION When stopping and leaving the machine, the two steering / park brake controls must be moved out to the locked position at the same time.

IMPORTANT INFORMATION Leaving the ignition switch in a position other than OFF will cause the battery to be discharged.

Operating on Hills

Read the Safety Instructions **Driving on Slopes** in the *Safety* section.

- Use the slowest speed possible before starting up or down hills.
- If stopping is fully necessary, pull steering / park brake controls into the neutral position and push outward to engage the park brake.
- Pull the steering / park brake controls back to the center of the mower and push forward to regain forward movement.

OPERATION

- Try not to stop or change speed on hills.
- Make all turns slowly.

⚠ WARNING! Do not drive the rider on terrain that slopes more than 10 degrees. Mow slopes up and down, never side to side. Avoid sudden directional changes.

Mowing Tips

- Find and flag rocks and other fixed objects to avoid collisions.
- Begin with a high cutting height and reduce it until the desired mowing result is attained. Cut the average lawn to 63.5 mm during the cool season and over 76.2 mm during the hot months. For healthier and better looking lawns, mow often after moderate growth.
- For best cutting performance, mow grass over 15.2 cm in height twice. Make the first cut relatively high; the second to the desired height.
- The mowing result will be best with a high engine speed (the blades rotate rapidly) and low speed (the rider moves slowly). If the grass is not too long and dense, the driving speed can be increased without negatively affecting the mowing result.
- When mowing large areas, start by turning to the right so that clippings will discharge away from shrubs, fences, driveways, etc. After one or two rounds, mow in the opposite direction making left hand turns until finished.

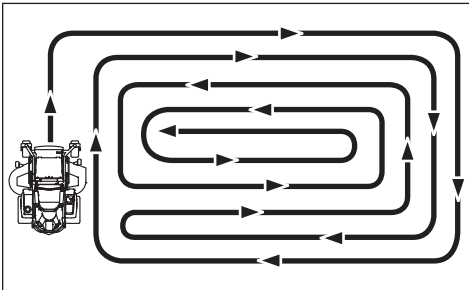

- The finest lawns are obtained by mowing often. The lawn becomes more even and the grass clippings more evenly distributed over the mown area. The total time taken is not increased as a higher operating speed can be used without poor mowing results.
- Avoid mowing wet lawns. The mowing result is poorer because the wheels sink into the soft lawn, clumps build, and grass clippings fasten under the cowlings.

- Hose the mower deck underside with water after each use. When cleaning, the mower deck shall be raised into the transport position. Make sure the mower is cooled and the engine is off.
- Use compressed air to clean top surface of the deck. Avoid flooding water on top surface, engine and electrical components.
- When the mulching kit is used, it is important that the mowing interval is frequent.

⚠ WARNING! Do not make adjustments unless:

- the engine is stopped,
- the ignition key is removed,
- the park brake is engaged

Moving Machine By Hand

Bypass Valves

Bypass valves are used to release the system so the machine may be moved by hand when not running.

Hydro Pumps

When pushing or pulling the mower, engage the bypass valve on each transaxle. Access to the valves is from the lower rear of the unit. The bypass valves are located on the front, inner sides of the transaxles. Set the deck to the lowest position when accessing the pump valves. To disengage each pump, turn the slot on the pump valve 45° clockwise from the RUN position to the BYPASS position.

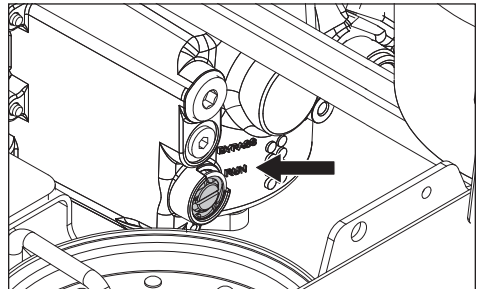

Load the machine into truck or trailer by driving up ramps in low gear. DO NOT LIFT! The machine is not intended to be lifted by hand.

⚠ WARNING! Use extreme caution when loading the machine into a truck or trailer using ramps. There is the possibility of serious injury or death if the machine falls off the ramps.

MAINTENANCE

Maintenance Schedule

Following is a list of maintenance procedures that must be performed on the machine. For those points not described in this manual, visit an authorized service workshop. An annual service

carried out by an authorized service workshop is recommended to maintain your machine in the best possible condition and to ensure safe operation.

Read **General Maintenance** in the *Safety* section.

| MAINTENANCE | DAILY | | AT LEAST ONCE EACH YEAR | MAINTENANCE INTERVAL IN HOURS | | |
|--|--------|-------|-------------------------|-------------------------------|-----|-----|
| | BEFORE | AFTER | | 50 | 250 | 500 |
| CHECK | | | | | | |
| Park brake for adjustment | ● | | ● | ● | ● | ● |
| Engine's oil level (every refueling) | ■ | | | | | |
| Safety system | ● | | | | | |
| For fuel and oil leakages | ◆ | | | | | |
| For damage | | ◆ | | ◆ | ◆ | ◆ |
| For loose hardware (screws, nuts) | | ● | | | | |
| For mower deck damage | | ● | | | | |
| Tire pressures | | ● | | ● | ● | ● |
| Battery connections | | | ● | ● | ● | ● |
| CLEAN | | | | | | |
| Engine's cooling air intake | | ■ | | | | |
| Under the mower deck | | ● | | ● | ● | ● |
| Around the engine | | ◆ | | ◆ | ◆ | ◆ |
| Around belts, belt pulleys | | ◆ | | ◆ | ◆ | ◆ |
| Engine's cooling air intake ²⁾ | | | ■ | ■ | ■ | ■ |
| Air cleaner foam pre-filter ²⁾ | | | ■ | | ■ | |
| Air cleaner paper filter cartridge ²⁾ | | | ■ | | ■ | |
| ALSO | | | | | | |
| Inspect muffler/spark arrestor | | | ◆ | ◆ | ◆ | ◆ |
| Start the engine & blades, listen for unusual sounds | | ◆ | | | | |
| Sharpen ³⁾ / Replace mower blades | | | ● | ● | ● | ● |

● = Described in this manual

◆ = Not described in this manual

■ = Refer to the engine manufacturer's manual

¹⁾ First change after 8-10 hours. When operating with a heavy load or at high ambient temperatures, replace every 50 hours.

²⁾ In dusty conditions, cleaning and replacement are required more often.

³⁾ Performed by authorized service workshop.



WARNING! Before performing service or adjustment:

- Engage the park brake.
- Place the blade switch in the disengaged position.
- Turn the ignition switch to OFF position and remove the key.
- Make sure the blades and all moving parts have stopped.

MAINTENANCE

| MAINTENANCE | DAILY | | AT LEAST ONCE EACH YEAR | MAINTENANCE INTERVAL IN HOURS | | |
|---|--------|-------|-------------------------------------|-------------------------------------|-----|-----|
| | BEFORE | AFTER | | 50 | 250 | 500 |
| CHECK | | | | | | |
| Throttle and choke cables for adjustment | | | | | ■ | |
| Mower deck for adjustment | | | ● | | | ● |
| Condition of belts, belt pulleys | | | ● | | ● | |
| Caster wheels (every 200 hours) | | | ● | | ● | |
| Hydraulic oil level | | ● | | | | |
| Engine valve clearance ³⁾ | | | ◆ | | | ◆ |
| CHANGE | | | | | | |
| Spark plugs | | | ■ | | ■ | |
| Engine oil ¹⁾ | | | ■ | ■ | | |
| Engine oil filter | | | ■ | | ■ | |
| Fuel filter | | | ■ | | ■ | |
| Paper air filter ²⁾ | | | ■ | | ■ | |
| Air cleaner foam pre-filter ²⁾ | | | ■ | | | |
| Air cleaner paper filter cartridge ²⁾ | | | ■ | | ■ | |
| Hydraulic oil (every 500 hours) | | | ● | | | ● |
| Hydraulic oil filter (every 500 hours) | | | ● | | | ● |
| ALSO | | | | | | |
| Dismantle and inspect starter ³⁾ (every 500 hours) | | | | | | ◆ |
| Perform the 500-hour service ³⁾ | | | ◆ | | | ◆ |

● = Described in this manual

◆ = Not described in this manual

■ = Refer to the engine manufacturer's manual

1) First change after 8-10 hours. When operating with a heavy load or at high ambient temperatures, replace every 50 hours.

2) In dusty conditions, cleaning and replacement are required more often.

3) Performed by authorized service workshop.



WARNING! Do not short battery terminals by allowing a wrench or other objects to contact the two terminals at the same time. Before connecting battery, remove metal bracelets, wristwatch bands, rings, etc. Positive terminal must be connected first to prevent sparks from accidental grounding.

IMPORTANT INFORMATION The mower is equipped with a 12-volt negative grounded system. The other vehicle must also be a 12-volt negative grounded system. Do not use your mower to start other vehicles.



CAUTION! Always wear eye protection when around batteries.

MAINTENANCE

Battery

If the battery is too weak to start the engine, it must be recharged.

Jumper Cable Use

1. Connect each end of the RED cable to the POSITIVE (+) terminal on each battery, taking care not to short against chassis.
2. Connect one end of the BLACK cable to the NEGATIVE (-) terminal of the fully charged battery.
3. Connect the other end of the BLACK cable to a good CHASSIS GROUND on the mower with the discharged battery, away from the fuel tank and battery.

To remove cables, reverse order

1. Remove BLACK cable first from chassis and then from the fully charged battery.
2. Remove RED cable last from the two batteries.

The mower is equipped with a maintenance free battery and does not need servicing. However, periodic charging of the battery with an automotive type battery charger will extend its life.

- Keep battery and terminals clean.
- Keep battery bolts tight.
- See chart for charging times.

| STD BATTERY | STATE OF CHARGE | APPROXIMATE CHARGING TIME* TO FULL CHARGE AT 80° F | | | |
|----------------|-----------------------|---|----------|----------|----------|
| | | Maximum Rate at: | | | |
| | | 50 Amps | 30 Amps | 20 Amps | 10 Amps |
| 12.6V | 100% | - FULL CHARGE - | | | |
| 12.4V | 75% | 20 min. | 35 min. | 48 min. | 90 min. |
| 12.2V | 50% | 45 min. | 75 min. | 95 min. | 180 min. |
| 12.0V | 25% | 65 min. | 115 min. | 145 min. | 280 min. |
| 11.8V | 0% | 85 min. | 150 min. | 195 min. | 370 min. |

*Charging time depends on battery capacity, condition, age, temperature and efficiency of charger

IMPORTANT INFORMATION Do open or remove caps or covers. Adding or checking the level of electrolyte is not necessary. Always use two wrenches for the terminal screws.

CAUTION! Lead-acid batteries generate explosive gases. Keep sparks, flame and smoking materials away from batteries.

Battery Removal

Corrosion and dirt on the battery and terminals can cause the battery to lose power.

1. Lift and rotate the seat fully forward until supported by the seat rod.
2. Remove the bolt and nut from the battery bracket and remove the bracket from the battery.

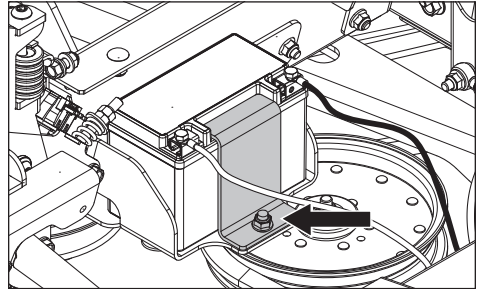

3. Using two wrenches, disconnect the BLACK battery cable then the RED battery cable.
4. Carefully remove the battery from the mower.

Cleaning

5. Rinse the battery with plain water and dry.
6. Clean the terminals and battery cable ends with a wire brush.

Replacing

7. Install the new battery with terminals in the same position as the old battery.
8. Connect RED battery cable first to positive (+) battery terminal.
9. Connect BLACK grounding cable to negative (-) battery terminal.
10. Fasten the battery in place with bracket removed in Step 2.

MAINTENANCE

Deck Maintenance

For all deck maintenance, make sure the mower is on a level surface. Stop the engine and engage the park brake. Remove the deck guards.

Cutting Blades

To attain the best mowing effect, it is important that blades are well sharpened and not damaged. Replace blades that have been bent or cracked when hitting obstacles.

CAUTION! Blades are sharp. Protect your hands with gloves and/or wrap blades with a heavy cloth when handling. The sharpening of blades should be carried out by an authorized service workshop.



Let the service workshop decide whether a blade with large nicks can be repaired/ground or must be replaced. Balance the blades after sharpening. Check the blade mounts.

Blade Replacement

1. Remove blade bolt by turning it counter clockwise.
2. Install new or resharpened blade with stamped GRASS SIDE facing towards ground/grass (down) or THIS SIDE UP facing deck and cutter housing.
3. Install and tighten blade bolt securely.
4. Torque blade bolt to 90 ft-lbs (122 Nm).

IMPORTANT INFORMATION Special blade bolt is heat treated. Replace with a Husqvarna bolt if required. Do not use lower grade hardware than specified.

V-belts

Check every 100 hours of operation. Check for severe cracking and large nicks.

NOTE: The belt will show some small cracks in normal operation.

Deck Belt

Deck Belt Removal

Park the mower on a level surface and engage the park brake. Lower the deck into the lowest cutting position.

1. Remove foot plate and belt shields.
2. Remove dirt or grass that may have accumulated around the cutter housings and entire deck surface.

3. Remove the belt guide hardware with a 1/2" wrench and set the belt guide aside.

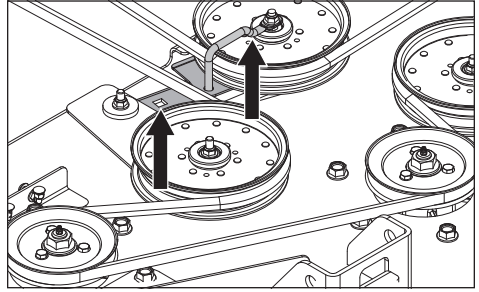

4. With a 1/2" breaker bar and using the square opening in the idler arm, shift the arm counter clockwise to relieve the tension on the belt.
5. Carefully lift the belt over the top of the cutter housing pulleys.
6. Remove the belt from around the electric clutch on the engine shaft.

Deck Belt Installation

NOTE: For ease in installing the deck belt, refer to the routing decal on the cutting deck.

1. Place the belt around all the pulleys except the center spindle pulley.
2. With a 1/2" breaker bar, shift the idler arm counter clockwise. When there is enough slack, slip the belt onto the center spindle pulley.
3. Reinstall the belt guide removed in Step 3 above.
4. Check belt routing to make sure it matches the routing decal and that the belt does not have twists.
5. Adjust belt tension by turning the eyebolt nut until there is approximately 22.2 mm - 25.4 mm of threads showing outside the nut.

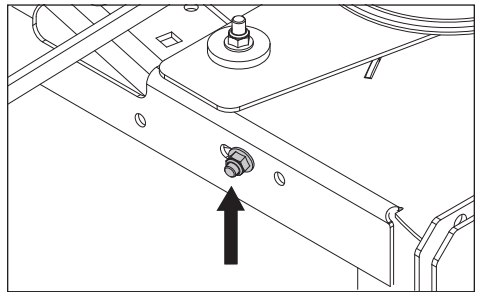

6. Belt tension must be set to 60-70 lbs.
7. Replace belt shields on the two mandrel housings and secure with fasteners.

MAINTENANCE

Pump Belt

The belts are not adjustable and need to be replaced if they begin to slip from wear. Park the mower on a level surface. Engage the park brake.

1. Remove the deck belt.
2. Remove clutch stop to access the belt.

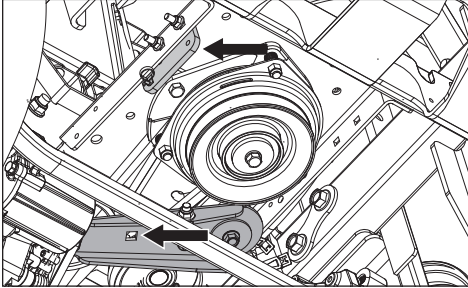

3. Disconnect clutch wire.
4. With a 1/2" breaker bar and using the square opening in the idler arm, shift the arm to create slack in the belt.
5. Remove belt from the engine and pump pulleys.

Reinstallation

1. Wrap the belt around the engine pulley and then around the left pump pulley.
2. Route the belt around the inside of the idler pulley.
3. With a 1/2" breaker bar and using the square opening in the idler arm, shift the arm to create slack in the belt.
4. While holding the idler back with the breaker bar, wrap the belt around the right pump pulley.
5. Replace and secure clutch stop. Reinstall the deck belt.
6. Check the belt tension. To tighten the belt, turn the nut on the idler eyebolt. The recommended belt tension is 27 lb.

Adjusting the Mower Deck

Leveling Deck

Adjust the deck while the mower is on a level surface. Make sure the tires are inflated to the correct pressure. See **Tire Pressures** in this section. If tires are under or over inflated, the deck cannot be properly adjusted. Faulty mower deck adjustments will cause an uneven mowing result.

Four bolts control the height and pitch of the mower deck. Adjust the deck slightly higher in the rear.

NOTE: To insure precision in the leveling procedure, mower deck drive belt must be installed prior to leveling the deck.

1. Wear heavy gloves. Turn each outer blade tip to align with the deck side-to-side.

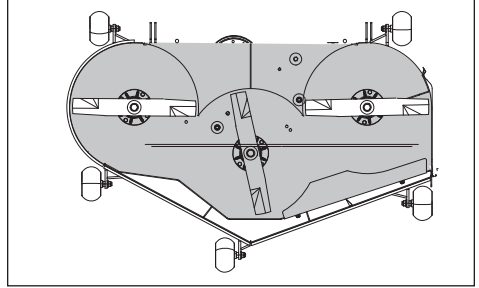

2. Measure from the floor surface up to the bottom of the blade tip on the discharge side of the mower deck. Record this measurement. Move to the opposite side; check that measurement is the same. If adjustment is required, loosen the locknut and adjust the bolt up until the two side to side measurements are equal. Retain measurement.

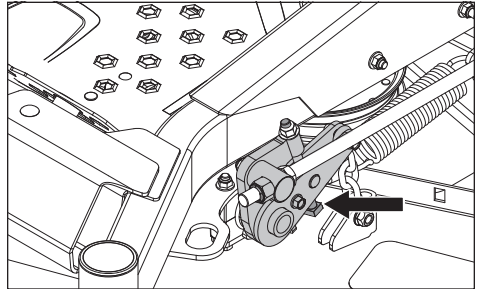

3. Turn the two outer blades to align with the deck front to rear. Reposition the rear blade mounting bolts up or down until the rear blade tips are positioned 3.175 mm - 9.525 mm higher in the rear than the front blade tips.
4. Confirm measurements once again. The blade tip height must be equal side to side. In the rear, the blade tips must be 3.175 mm - 9.525 mm higher than the front measurement. In the front, blade tips must be equal from side to side.

NOTE: This will place the mower deck in a standard measurement position. Depending on the type of grass being mowed or environmental conditions, more adjustments may be required to get the desired cut.

MAINTENANCE

Deck Lift Spring

When mowing 5.1 cm or lower, it may be necessary to adjust the deck lift springs. Access the springs by tilting the seat forward. Loosen the nut to adjust the spring tension.

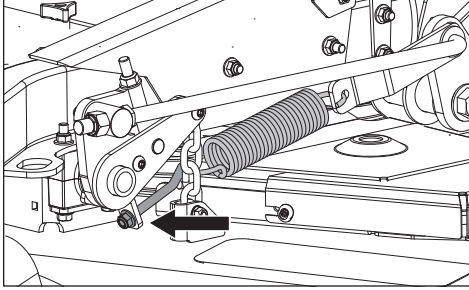

Neutral Adjustment

Perform the adjustment with the machine parked on level ground and the park brake engaged.

1. Raise the rear wheels of the machine and support it with jack stands.
2. Start the engine. If the either wheel turns while the machine's park brake is engaged, the neutral linkage for the corresponding wheel must be adjusted.
3. To access the control rod linkage, unlatch and rotate the seat forward.

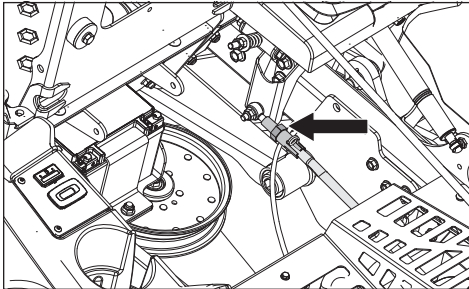

4. Remove and retain the pin from the front coupler.
5. Turn the hex nut by hand in either direction until the wheel stops turning.
6. Turn the hex again, counting the number of turns with the flat surfaces of the nut. Stop turning when the wheel spins in the opposite direction.
7. Turn the nut back, one half of the amount of turns counted in Step 6.
8. Repeat with the opposite wheel if necessary.

Park Brake

WARNING! Faulty adjustment will result in reduced braking and can cause an accident.

Visually check that no damage is found on the steering control levers, links or switches belonging to the park brake. Do a standstill test and check that there is sufficient braking action.

1. Make equal adjustments on the two park brake controls. To make adjustments, remove the rivet pins from the boot and slide the boot up.
2. If the park brake position does not pass the standstill test, or has needed maintenance, it may need adjustment. The spring should measure a compressed length of 12.7 mm shorter than the free length. Tighten the nuts holding the brake spring if necessary.

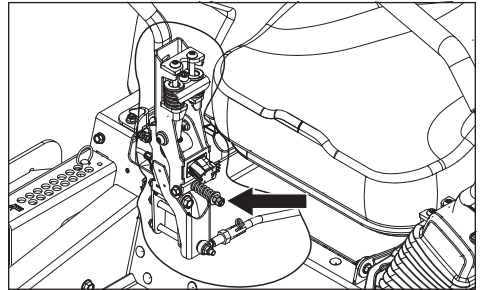

3. To change the park brake action, tighten the pivot bolt until the desired braking feel is correct.

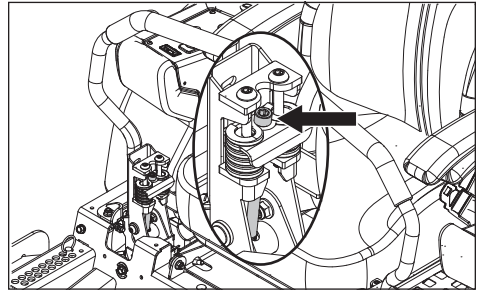

Tire Pressures

All tires must be at 15 psi / 103 kPa / 1 bar.

IMPORTANT INFORMATION DO NOT add a tire liner or foam fill material to the rear tires. Excessive loads created by foam filled tires will cause premature failures.

Only use O.E.M. specified tires.

MAINTENANCE

Safety System

The machine is equipped with a safety system that prevents starting or driving under the following conditions.

The engine can only be started when:

- the mower deck is disengaged.
- the steering / park brake controls are in the outer, locked neutral position, making sure of full parking brake engagement for a safe startup.

NOTE: If the steering / park brake controls are not holding in the full outboard position, the tension can be adjusted. (See Park Brake in this section).

Make daily inspections to make sure that the safety system works by trying to start the engine when one of the conditions is not met. Change the conditions and try again.

Make sure the engine stops when the park brake is not engaged and the operator leaves the seated position.

Make sure the engine stops if the mower blades are engaged and the driver leaves the seated position.

IMPORTANT INFORMATION To drive, the driver must sit in the seat and the steering / park brake controls must be moved into the engaged (outer) position. Otherwise the engine will stop.

Caster Wheels

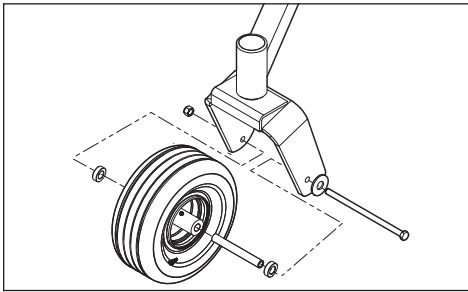

Check every 200 hours. Check that wheels rotate freely.

To replace, remove nut and caster bolt. Pull the wheel out of the fork. Install in reverse order. Tighten caster bolt. Torque to 50 ft-lbs (67.8 Nm).

NOTE: Tire must rotate freely but axle spacers must not. If wheels do not rotate freely take the unit to the dealer for service.

Anti-scalp Rollers

Anti-scalp rollers keep the deck in the proper position to help prevent scalping in most terrain conditions. Do not adjust the rollers to support the deck.

IMPORTANT INFORMATION Adjust anti-scalp rollers with the mower on a flat level surface. To avoid deck damage, the anti-scalp rollers must not be adjusted to support the deck.

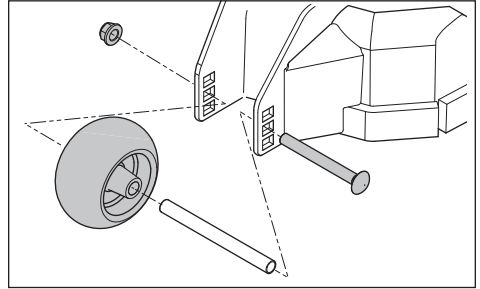

Anti-scalp rollers can be set in three positions.

- Upper 38 mm - 64 mm grass
- Middle 64 mm - 102 mm grass
- Lower 102 mm - 127 mm grass

The rollers must be approximately 6.35 mm from ground. Do not adjust the rollers to support the deck.

Cleaning



CAUTION! Always wear eye protection when cleaning and washing.

Regular cleaning and washing, especially under the mower deck, will increase the machine's life-span. Make it a habit to clean the machine directly after use (after it is cooled), before the dirt sticks.

Do not spray water on the top of the mower deck. Use compressed air to clean the top side of mower deck. Regularly clean deck and underside of the deck with normal water pressure. Do not use a high pressure washer or steam cleaner. Avoid spraying engine and electrical components with water.

Do not rinse hot surfaces with cold water. Let unit cool before washing.

Hardware

Check daily. Inspect the entire machine for loose or missing hardware.

LUBRICATION

Lubrication Schedule

| 12/12 | 1/52 | 1/365 | | 50h | 250h | 500h | |
|-------|------|-------|--|------|------|------|--|
| | | | | (2x) | (2x) | (2x) | |
| | | | | (2x) | (2x) | (2x) | |
| | | | | (3x) | (3x) | (3x) | |
| | | 4 | | | | | |
| | | | | 5 | | | |
| | | | | * | | | |

| | |
|-------|------------|
| 12/12 | Every year |
| 1/52 | Every Week |
| 1/365 | Every day |

- * Initial hydraulic oil and filter change at 100 hrs, every 400 hrs thereafter.
- ▲ Change engine oil every 50 hours.

| | |
|---------------------------|--|
| Lubricate with grease gun | |
| Filter change | |
| Oil change | |
| Level check | |

General

Remove the ignition key to prevent accidental movements during lubrication.

When lubricating with an oil can, it must be filled with engine oil. When lubricating with grease, unless otherwise stated, use high grade molybdenum disulphide grease.

For daily use, the machine must be lubricated twice weekly.

Wipe away excess grease after lubrication. It is important to avoid getting lubricant on the belts or the drive surfaces on the belt pulleys. If this happens, clean them with spirits. If the belt continues to slip after cleaning, it must be replaced. Gasoline or other petroleum products must not be used to clean belts.

WARNING! Escaping hydraulic oil under pressure can have sufficient force to penetrate the skin, causing serious injury. If injured by escaping fluid, see a doctor at once. Serious infection or reaction can develop if proper medical treatment is not administered immediately.

IMPORTANT INFORMATION Use minimal lubrication and remove excess lubricant so that it does not come into contact with belts or belt pulley drive surfaces.

LUBRICATION

Engine oil

NOTE: Change the engine oil when the engine is warm. Refer to the engine owner's manual for the correct replacement oil and filter change recommendations.

⚠ WARNING! The engine drain plug is located close to the muffler. To prevent burns, the engine should be shut off and allowed to cool slightly so the engine is still warm but the surrounding surfaces and oil are not.

1. Park on a level surface. Engage the park brake.
2. Clean the dirt and debris from the area around the oil fill cap.
3. Remove the cap/dipstick.
4. Locate the drain hose at the right rear of the engine below the muffler. Put an adequately sized container under the end of the drain hose and remove the oil drain plug.

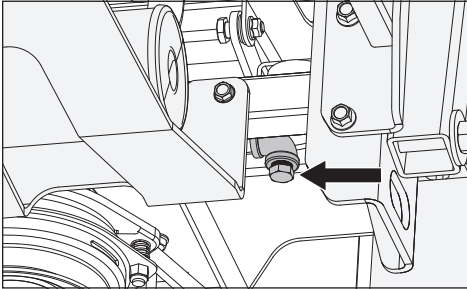

5. Let the oil to fully drain from the engine.
6. Replace the drain hose plug and tighten securely.
7. Fill the engine with new oil to the bottom of the fill tube threads. Check the level with the dipstick.
8. Replace the oil fill cap securely when the oil level is FULL.
9. Refer to the Service Journal for oil checking and changing intervals.

Wheel and Deck Zerk

Use only good quality bearing grease. Grease from well-known brand names (petrochemical companies, etc.) usually maintains a good quality.

Front Wheel Mount

Remove dust cap to expose zerk. Lubricate with a grease gun until the grease is forced out around the top washer.

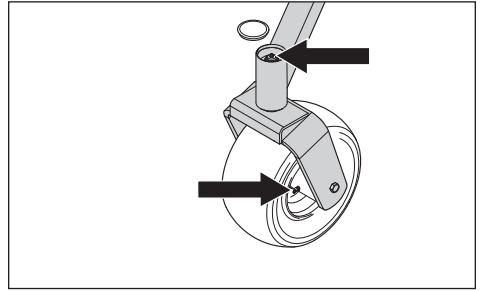

Front Wheel Bearings

Lubricate 3-4 strokes with a grease gun on each set of wheel bearings.

Deck Spindles

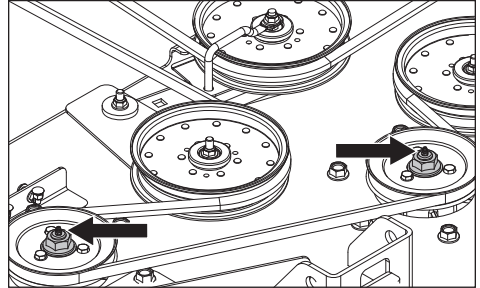

10. Lower the cutting deck completely.
11. If a grease gun without rubber hose is used, the foot plate must be removed to access the center spindle.
12. Lubricate with a grease gun, 2-3 strokes per spindle.

Transaxle Fluid Change

Fluid and Filter Change

The hydraulic drive is designed with an external filter for ease of maintenance. To ensure constant fluid quality levels and longer life, an oil filter change interval of every 400 hours is recommended.

Drain old oil filters of all free-flowing oil prior to disposal. Place used oil in appropriate containers and dispose of it in accordance with laws in your area.

The following procedure is performed with the pump installed in the vehicle, and the vehicle on level ground.

1. Park on a level surface. Engage the park brake.
2. Place an oil drain pan with a 8 quart capacity beneath the oil reservoir.
3. Remove the oil filter cover and discard the gasket.

LUBRICATION

4. After the oil has drained remove the filter from the housing.
5. Install a new filter and gasket into the filter cover and install the assembly into the transaxle, turning it three-quarters to one full turn after the filter gasket contacts the filter base surface.

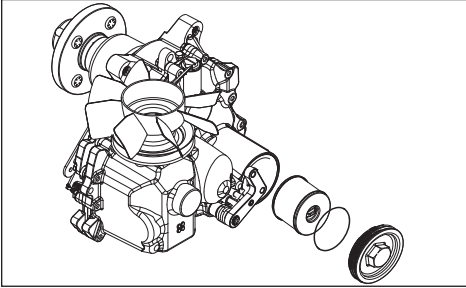

6. Repeat the procedure the opposite side.
7. Remove the top port vent plug from the left side and right side of the transaxles prior to filling with oil.

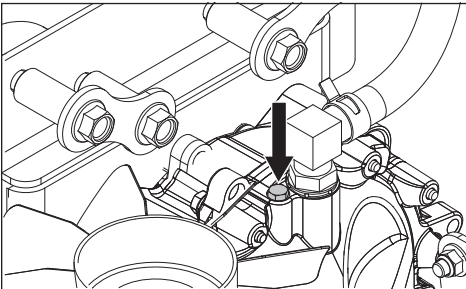

8. Fill with 20W50 motor oil until the oil appears at the bottom of each transaxles' top port with approximately 2 quarts (1.89 liters) per transaxle, 4 quarts (3.78 liters) total.
9. Install the fill plugs into each transaxle as the oil level reaches the port. Torque the top port plugs to 180 in./lbs.
10. Continue to fill the transaxles through the expansion tank until the FULL COLD line is reached. This will take approximately 23 additional ounces (0.68 liter).
11. Reinstall the expansion tank cap by hand. Do not overtighten.

Transmission Purging

Due to the effects air has on efficiency in hydrostatic drive applications, it is critical to purge the system.

Perform the procedure first with the vehicle drive wheels off the ground, then repeated under normal operating conditions.

Resulting symptoms in hydrostatic systems may be:

- Noisy operation.
- Lack of power or drive after short term operation.
- High operation temperature and excessive expansion of oil.
- Shortened component life.

Purge procedures must be implemented if the hydrostatic system has been opened for maintenance or when more oil has been added to the system.

Before starting, make sure the oil tank is at the proper oil level. If not, fill to the specifications outlined above.

See **Moving Machine By Hand** in the *Operation* section for bypass linkage adjustments.

1. Release the park brake.
2. With the bypass valve open and the engine running at fast idle, slowly move the steering controls in the forward and reverse directions five or six times. As air is purged from the unit, the oil level will drop.
3. With the bypass linkage valve and the engine running, slowly move the steering controls in the forward and reverse directions five or six times. Check the oil level and add oil as required after stopping the engine.
4. It may be necessary to repeat Steps 2 and 3 until all the air is completely purged from the system. When the hydraulic drive operates at normal noise levels and moves smoothly forward and reverse at normal speeds, the hydraulic drive is considered purged.

TROUBLESHOOTING

Problem / Cause

Engine will not start

- Blade switch is engaged
- Steering controls are not locked in the park brake position
- Dead battery
- Contamination in the carburetor or fuel line
- Fuel supply shutoff valve is closed or in the wrong position
- Clogged fuel filter or fuel line
- Ignition system faulty

Starter does not turn the engine over

- Dead battery
- Battery terminal cable contacts are defective
- Blown fuse
- Fault in the starter safety circuit. See **Safety System** in the *Maintenance* Section

Engine runs rough

- Faulty carburetor
- Clogged fuel filter or jet
- Choke is engaged with a warm engine
- Clogged ventilation valve on the fuel cap
- Fuel tank nearly empty
- Fouled spark plugs
- Rich fuel mixture or fuel-air mixture.
- Wrong fuel type
- Water in fuel
- Clogged air filter

Engine seems weak

- Clogged air filter
- Fouled spark plugs
- Carburetor incorrectly adjusted
- Air trapped in hydraulic system

Machine vibrates

- Blades are loose
- Blades are incorrectly balanced
- Engine is loose

Engine overheats

- Clogged air intake or cooling fins
- Engine overloaded
- Poor ventilation around engine
- Defective engine speed regulator
- Too little or no oil in the engine
- Contamination in the fuel line
- Fouled spark plugs

Battery not charging

- Battery terminal cable contacts are defective
- Charging lead is disconnected
- Fault in engine charging system

Mower moves slowly, unevenly, or not at all

- Park brake is engaged
- Bypass valve on pump is open
- Transmission drive belt is slack or off
- Air trapped in hydraulic system

Mower deck not engaging

- Drive belt for the mower deck is loose
- Electromagnetic coupling contact is loose
- Blade switch is faulty or loose from cable contact
- Blown fuse

Transaxle leaks oil

- Damaged seals, housing, or gaskets
- Air trapped in hydraulic system

Uneven mowing results

- Unequal air pressures in tires
- Bent blades
- Suspension for the mower deck is uneven
- Blades are dull
- Driving speed too high
- Grass is too long
- Grass has collected under the mower deck

STORAGE

Winter Storage

The machine must be readied for storage at the end of the mowing season, or if it will not be in use for more than thirty days.

Fuel allowed to stand for long periods of time (thirty days or more) can leave sticky residues that can plug the carburetor and disrupt engine function.

Fuel stabilizers are an permitted option as regards to the sticky residues that can occur during storage.

Add stabilizer to the fuel in the tank or in the storage container. Always use the mixing ratios specified by the manufacturer of the stabilizer. Run the engine for at least ten minutes after adding the stabilizer so that it reaches the carburetor. Do not empty the fuel tank and the carburetor if a stabilizer has been added.



WARNING! Do not store an engine with fuel in the tank indoors or in poorly ventilated spaces where fuel vapor can come in contact with open flames, sparks, or a pilot light such as in a boiler, hot water tank, clothes dryer, etc. Handle the fuel with care. It is very flammable and can cause serious personal injury and property damage. Drain the fuel into an approved container outdoors and store far away from open flame or sources of ignition. Do not use gasoline for cleaning. Use a degreaser and warm water.

To ready the machine for storage:

1. Thoroughly clean the machine, especially under the mower deck. Touch up damage to the paint and spray a thin layer of oil on the underside of the mower deck to avoid corrosion.
2. Inspect the machine for worn or damaged parts and tighten nuts or screws that may have become loose.
3. Change the engine oil; dispose of properly.
4. Empty the fuel tanks or add a fuel stabilizer. Start the engine and let it run until the carburetor is drained of fuel or the stabilizer has reached the carburetor.
5. Remove the spark plug and pour about a tablespoon of engine oil into the cylinder. Turn over the engine so that the oil is evenly distributed and then refit the spark plug.
6. Lubricate all grease zerks, joints, and axles.
7. Remove the battery. Clean, charge, and store the battery in a cool place, but protect it from direct cold.
8. Store the machine in a clean, dry place and cover it for extra protection.

Service

When ordering spare parts, please specify the purchase year, model, type, and serial number.

Always use genuine Husqvarna spare parts.

An annual check-up at an authorized service workshop is a good way to ensure that the machine performs its best the following season.

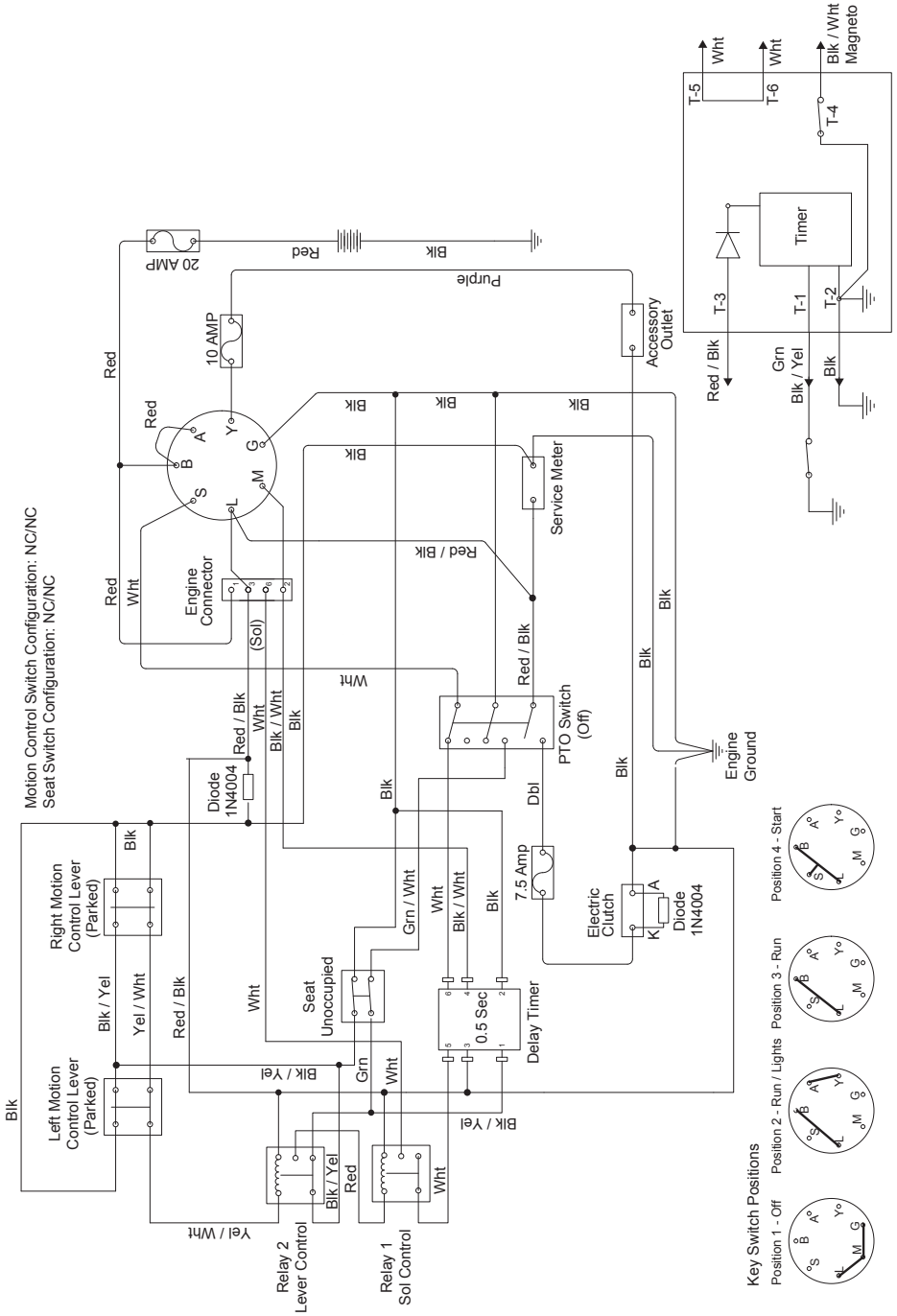

CONFORMITY

EC Declaration Of Conformity

We, Husqvarna AB, SE 561 82 Huskvarna, SWEDEN, declare under our sole responsibility that the represented product:

| | |
|-------------------------|---|
| Description | Combustion-engine-powered ride-on lawn mower with seated operator |
| Brand | Husqvarna |
| Platform / Type / Model | Z560X |
| Batch | Serial number dating 2017 and onwards |

complies fully with the following EU directives and regulations:

| Directive/Regulation | Description |
|------------------------|---|
| 2006/42/EC | "relating to machinery" |
| 2014/30/EU | "relating to electromagnetic compatibility" |
| 2000/14/EC; 2005/88/EC | "relating to outdoor noise" |

Harmonized standards and/or technical specifications applied are as follows;

EN ISO 12100, ISO 14982, ISO 5395-1 & 3, ISO 3744, ISO 11094, EN 1032, ISO 21299

In accordance with directive 2000/14/EC, Annex V, the declared sound values are stated in the technical data section of this manual and in the signed EC Declaration of Conformity.

The supplied combustion-engine-powered ride-on lawn mower with seated operator conforms to the example that underwent examination.

TECHNICAL DATA

| ENGINE | |
|----------------------------|--|
| Manufacturer | Briggs & Stratton |
| Type | Vanguard 810 |
| Power | 17.34 kW @ 2900 ¹⁾ |
| Lubrication | Pressure with oil filter |
| Fuel | Min 87 octane unleaded (Max ethanol 10%, Max MTBE 15%) |
| Fuel tank capacity | 45.42 litres |
| Cooling | Air cooled |
| Air filter | Cyclonic |
| Alternator | 12v 15 amp @ 3600 rpm |
| Starter | Electric |
| TRANSMISSION | |
| Transmission | HydroGear ZT5400 |
| Steering control | Dual levers, foam gripped |
| Speed forward | 0-19.6 km/h |
| Speed reverse | 0-8 km/h |
| Brakes | Integrated Mechanical Park Brake |
| Front caster tires | 13 x 6.5 Flat Free |
| Rear tires, turf pneumatic | 24 x 12-12 |
| Tire pressure | 15 PSI / 103 kPa / 1 bar |
| FRAME | |
| Cutting Width | 152.4 cm |
| Cutting Height | 2.5 cm - 12.7 cm |
| Number of Blades | 3 |
| Blade Length | 53.34 cm |
| Anti-scalp roller | 4 adjustable |
| Seat | Husqvarna Commercial Suspension |
| Hinged Arm Rests | Yes |
| Service Meter | Digital |
| Blade Engagement | Clutch 250 ft/lbs |
| Deck Construction | 7 gauge fabricated |
| Productivity | 23, 472 m ² /h |

¹⁾ The power rating as declared by the engine manufacturer is the average gross power output at the specified RPM of a typical production engine for the engine model measured using SAE Standards for engine gross power. Refer to the engine manufacturer engine specifications.

TECHNICAL DATA

| DIMENSIONS | |
|---------------------------|-----------------------|
| Weight | 594 kg |
| Base Machine Length | 210 cm |
| Base Machine Height | 127 cm |
| Base Machine Width | 138.4 cm |
| Overall Width, Chute Up | 162 cm |
| Overall Width, Chute Down | 188 cm |
| Overall Height, ROPS up | 183 cm |
| VIBRATION AND SOUND | |
| Hand/Arm Vibration | 1.27 m/s ² |
| Whole Body Hand/Arm | 0.08 m/s ² |
| Sound Level, Measured | 105 dB |
| Sound Level, Guaranteed | 105 dB |

TECHNICAL DATA

Torque Specifications

| | | | |
|------------------------|-----------|--------------------------|----------|
| Engine crankshaft bolt | 50 ft/lb | Standard 1/4" fasteners | 9 ft/lb |
| Deck pulley bolts | 150 ft/lb | Standard 5/16" fasteners | 18 ft/lb |
| Lug nuts | 75 ft/lb | Standard 3/8" fasteners | 33 ft/lb |
| Blade bolt | 90 ft/lb | Standard 7/16" fasteners | 52 ft/lb |
| | | Standard 1/2" fasteners | 80 ft/lb |

HEX HEAD CAP SCREWS

The torque values shown must be used as a general guideline when specific torque values are not given.

U.S. Standard Hardware

| Grade | | SAE Grade 5 | | SAE Grade 8 | | Flangelock Screw w/Flangelock Nut | |
|--|-------|-------------|------|-------------|------|-----------------------------------|----|
| | Size | ft./lbs | Nm | ft./lbs | Nm | ft./lbs | Nm |
| Shank Size (Diameter in inches, fine or coarse thread) | 1/4 | 9 | 12 | 13 | 18 | | |
| | 5/16 | 18 | 24 | 28 | 38 | 24 | 33 |
| | 3/8 | 31 | 42 | 46 | 62 | 40 | 54 |
| | 7/16 | 50 | 68 | 75 | 102 | | |
| | 1/2 | 75 | 102 | 115 | 156 | | |
| | 9/16 | 110 | 149 | 165 | 224 | | |
| | 5/8 | 150 | 203 | 225 | 305 | | |
| | 3/4 | 250 | 339 | 370 | 502 | | |
| | 7/8 | 378 | 512 | 591 | 801 | | |
| | 1-1/8 | 782 | 1060 | 1410 | 1912 | | |

** Grade 5 - Minimum commercial quality (lower quality not recommended)

Metric Standard Hardware

| Grade | | Grade 8.8 | | Grade 10.9 | | Grade 12.9 | |
|---|------|-----------|-----|------------|-----|------------|-----|
| | Size | ft./lbs | Nm | ft./lbs | Nm | ft./lbs | Nm |
| Shank Size (Diameter in millimeters, fine or coarse thread) | M4 | 1.5 | 2 | 2.2 | 3 | 2.7 | 3.7 |
| | M5 | 3 | 4 | 4.5 | 6 | 5.2 | 7 |
| | M6 | 5.2 | 7 | 7.5 | 10 | 8.2 | 11 |
| | M7 | 8.2 | 11 | 12 | 16 | 15 | 20 |
| | M8 | 13.5 | 18 | 18.8 | 25 | 21.8 | 30 |
| | M10 | 24 | 33 | 35.2 | 48 | 43.5 | 59 |
| | M12 | 43.5 | 59 | 62.2 | 84 | 75 | 102 |
| | M14 | 70.5 | 96 | 100 | 136 | 119 | 161 |
| | M16 | 108 | 146 | 147 | 199 | 176 | 239 |
| | M18 | 142 | 193 | 202 | 274 | 242 | 328 |
| | M20 | 195 | 264 | 275 | 373 | 330 | 447 |
| | M22 | 276 | 374 | 390 | 529 | 471 | 639 |
| | M24 | 353 | 478 | 498 | 675 | 596 | 808 |
| M27 | 530 | 719 | 735 | 996 | 904 | 1226 | |

SERVICE JOURNAL

DELIVERY SERVICE

| Action | Date, mtr reading, stamp, sign |
|--|--------------------------------|
| Charge and connect the battery | <input type="checkbox"/> |
| Adjust the tire pressure of all wheels to 15 PSI (1 bar) | <input type="checkbox"/> |
| Mount the steering controls in the normal position | <input type="checkbox"/> |
| Connect the contact box to the cable for the seat's safety switch | <input type="checkbox"/> |
| Check that the right amount of oil is in the engine | <input type="checkbox"/> |
| Adjust the position of the steering controls | <input type="checkbox"/> |
| Fill with fuel and open the fuel shut off valve | <input type="checkbox"/> |
| Start the engine | <input type="checkbox"/> |
| Check that there is drive to the two wheels | <input type="checkbox"/> |
| Check mower deck pitch and adjustment | <input type="checkbox"/> |
| Check: | |
| Safety switch for the park brake | <input type="checkbox"/> |
| Safety switch for the mower deck | <input type="checkbox"/> |
| Safety switch in the seat | <input type="checkbox"/> |
| Safety switch in the steering controls | <input type="checkbox"/> |
| Park brake functionality and adjustment | <input type="checkbox"/> |
| Driving forward | <input type="checkbox"/> |
| Driving backward | <input type="checkbox"/> |
| Engaging the blades | <input type="checkbox"/> |
| Idle speed | <input type="checkbox"/> |
| Engine high idle speed | <input type="checkbox"/> |
| Inform the customer about: | |
| Need and advantages of following the service schedule | <input type="checkbox"/> |
| Need and advantages of leaving the machine for service | <input type="checkbox"/> |
| Effects of service and maintaining a service journal on the machine's resale value | <input type="checkbox"/> |
| Application areas for mulching | <input type="checkbox"/> |
| Fill in the sales papers, etc. | |

Delivery service has
been carried out

No remaining notes

Certified:

SERVICE JOURNAL

AFTER 10 HOURS

| Action | Date, mtr reading, stamp, sign |
|-----------------------------------|--------------------------------|
| Change the engine oil | <input type="checkbox"/> |
| Change the oil filter | <input type="checkbox"/> |
| Inspect hydraulic hoses | <input type="checkbox"/> |
| Inspect hydraulic belt | <input type="checkbox"/> |
| Inspect hydraulic filter | <input type="checkbox"/> |
| Check neutral position | <input type="checkbox"/> |
| Check safety system | <input type="checkbox"/> |
| Check seat belt | <input type="checkbox"/> |
| Check ROPS | <input type="checkbox"/> |
| Check fuel system for leaks | <input type="checkbox"/> |
| Inspect safety guards and shields | <input type="checkbox"/> |
| Check brake adjustment | <input type="checkbox"/> |

DAILY SERVICE

| Action | Date, mtr reading, stamp, sign |
|---|--------------------------------|
| Clean debris from mower | <input type="checkbox"/> |
| Check engine oil level | <input type="checkbox"/> |
| Check the tire pressures | <input type="checkbox"/> |
| Check underside of deck | <input type="checkbox"/> |
| Inspect deck pulleys | <input type="checkbox"/> |
| Check/clean the engine's cooling air intake | <input type="checkbox"/> |
| Check safety system | <input type="checkbox"/> |
| Check seat belt | <input type="checkbox"/> |
| Check ROPS | <input type="checkbox"/> |
| Check fuel system for leaks | <input type="checkbox"/> |
| Inspect safety guards and shields | <input type="checkbox"/> |
| Check brake adjustment | <input type="checkbox"/> |

SERVICE JOURNAL

50-HOUR SERVICE

| Action | Date, mtr reading, stamp, sign |
|---|--------------------------------|
| Clean debris from mower | <input type="checkbox"/> |
| Check engine oil level | <input type="checkbox"/> |
| Check the tire pressures | <input type="checkbox"/> |
| Check underside of deck | <input type="checkbox"/> |
| Inspect deck pulleys | <input type="checkbox"/> |
| Check/clean the engine's cooling air intake | <input type="checkbox"/> |
| Check safety system | <input type="checkbox"/> |
| Check seat belt | <input type="checkbox"/> |
| Check ROPS | <input type="checkbox"/> |
| Check fuel system for leaks | <input type="checkbox"/> |
| Inspect safety guards and shields | <input type="checkbox"/> |
| Check brake adjustment | <input type="checkbox"/> |

SERVICE JOURNAL

250-HOUR SERVICE

| Action | Date, mtr reading, stamp, sign |
|---|--------------------------------|
| Grease fittings (caster pivots and caster wheels) | <input type="checkbox"/> |
| Inspect dampers | <input type="checkbox"/> |
| Inspect frame | <input type="checkbox"/> |
| Inspect throttle and choke cables | <input type="checkbox"/> |
| Inspect hardware | <input type="checkbox"/> |
| Check the tire pressures | <input type="checkbox"/> |
| Change the engine oil and filter | <input type="checkbox"/> |
| Change air filter | <input type="checkbox"/> |
| Inspect spark plug | <input type="checkbox"/> |
| Inspect fuel filter | <input type="checkbox"/> |
| Check engine RPM | <input type="checkbox"/> |
| Clean underside of deck | <input type="checkbox"/> |
| Check blade pitch | <input type="checkbox"/> |
| Grease blade spindles | <input type="checkbox"/> |
| Inspect spindle bearings | <input type="checkbox"/> |
| Inspect deck belt and blades | <input type="checkbox"/> |
| Inspect idler arm bearings | <input type="checkbox"/> |
| Inspect deck idler pulleys | <input type="checkbox"/> |
| Inspect hydraulic filter | <input type="checkbox"/> |
| Inspect hydraulic drive belt | <input type="checkbox"/> |
| Inspect hydraulic hoses | <input type="checkbox"/> |
| Check neutral position | <input type="checkbox"/> |
| Inspect battery connections | <input type="checkbox"/> |
| Check safety system | <input type="checkbox"/> |
| Check seat belt | <input type="checkbox"/> |
| Check ROPS | <input type="checkbox"/> |
| Check fuel system for leaks | <input type="checkbox"/> |
| Inspect safety guards and shields | <input type="checkbox"/> |
| Check brake adjustment | <input type="checkbox"/> |

SERVICE JOURNAL

500-HOUR SERVICE

| Action | Date, mtr reading, stamp, sign |
|---|--------------------------------|
| Grease fittings (caster pivots and caster wheels) | <input type="checkbox"/> |
| Inspect dampers | <input type="checkbox"/> |
| Inspect frame | <input type="checkbox"/> |
| Inspect throttle and choke cables | <input type="checkbox"/> |
| Inspect hardware | <input type="checkbox"/> |
| Check the tire pressures | <input type="checkbox"/> |
| Change the engine oil and filter | <input type="checkbox"/> |
| Change air filter | <input type="checkbox"/> |
| Inspect spark plug | <input type="checkbox"/> |
| Inspect fuel filter | <input type="checkbox"/> |
| Check engine RPM | <input type="checkbox"/> |
| Clean underside of deck | <input type="checkbox"/> |
| Check blade pitch | <input type="checkbox"/> |
| Grease blade spindles | <input type="checkbox"/> |
| Inspect spindle bearings | <input type="checkbox"/> |
| Inspect deck belt and blades | <input type="checkbox"/> |
| Inspect idler arm bearings | <input type="checkbox"/> |
| Inspect deck idler pulleys | <input type="checkbox"/> |
| Change hydraulic oil level | <input type="checkbox"/> |
| Change hydraulic filter | <input type="checkbox"/> |
| Replace hydraulic drive belt | <input type="checkbox"/> |
| Inspect hydraulic hoses | <input type="checkbox"/> |
| Check neutral position | <input type="checkbox"/> |
| Inspect battery connections | <input type="checkbox"/> |
| Load test battery | <input type="checkbox"/> |
| Clean electrical connections | <input type="checkbox"/> |
| Inspect the clutch | <input type="checkbox"/> |
| Check safety system | <input type="checkbox"/> |
| Check seat belt | <input type="checkbox"/> |
| Check ROPS | <input type="checkbox"/> |
| Check fuel system for leaks | <input type="checkbox"/> |
| Inspect safety guards and shields | <input type="checkbox"/> |
| Check brake adjustment | <input type="checkbox"/> |

SERVICE JOURNAL

AT LEAST ONCE EACH YEAR

| Action | Date, mtr reading, stamp, sign |
|---|--------------------------------|
| Clean the engine's cooling air intake | <input type="checkbox"/> |
| Replace the air cleaner's foam pre-filter | <input type="checkbox"/> |
| Replace the air filter's paper cartridge | <input type="checkbox"/> |
| Change the engine oil | <input type="checkbox"/> |
| Replace the engine oil filter | <input type="checkbox"/> |
| Check/adjust the cutting height | <input type="checkbox"/> |
| Check/adjust the park brake | <input type="checkbox"/> |
| Clean/Change the spark plugs | <input type="checkbox"/> |
| Inspect spark plug | <input type="checkbox"/> |
| Check the engine valve clearance | <input type="checkbox"/> |



www.husqvarna.com

2017-12-15