



Art. 19032

EN **Operator's manual**
smart Irrigation Control

GARDENA smart Irrigation Control 24 V

1. SAFETY	4
2. ASSEMBLY	6
3. INSTALLATION	8
4. OPERATION	19
5. MAINTENANCE	22
6. STORAGE	22
7. TROUBLESHOOTING	23
8. TECHNICAL DATA	25
9. ACCESSORIES	26
10. SERVICE/WARRANTY	27

Original instructions.



For safety reasons, children and young people under 16 as well as anyone who is not familiar with these operating instructions should not use the product. Persons with reduced physical or mental abilities may use the product only if they are supervised or instructed by a responsible person. Children must be supervised to ensure that they do not play with the product. Never operate the product when you are tired, ill or under the influence of alcohol, drugs or medicine.

Intended use:

The **GARDENA smart Irrigation Control** is intended for private use in domestic and hobby gardens, to control sprinklers and watering systems. It can be used for automatic watering during holidays. It is only intended for use in a weatherproof and dust-proof location. It is not intended for indoor use.

The **GARDENA smart Irrigation Control** is part of a garden irrigation system and can only be programmed together with the **GARDENA smart Gateway Art. 19000**.

The **GARDENA smart Irrigation Control** is controlled automatically with the **GARDENA smart system App**. Sprinklers, a sprinkler system or a drip head watering system can be used for watering.

The **GARDENA smart Irrigation Control** carries out watering fully automatically according to the set program and can therefore also be used during holidays. Early in the morning or late in the evening, evaporation and therefore water consumption is lowest.



DANGER! Risk of injury!

The product must not be used for industrial purposes or in conjunction with chemicals, foodstuffs, easily flammable and explosive materials.

1. SAFETY

Important!
Read the operator's manual carefully before use and keep for future reference.

Symbols on the product:



Read operator's manual.

Electrical safety



DANGER! Cardiac arrest!

This product makes an electromagnetic field while it operates. This field may under some conditions interfere with active or passive medical implants.

To decrease the risk of conditions that can possibly injure or kill, we recommend persons with medical implants to speak with their physician and the medical implant manufacturer before you operate the product.



DANGER!
Electric shock!

Risk of injury due to electric shock.

The product must be supplied through a residual current device (RCD) having a rated residual operating current not exceeding 30 mA.

The product must only be operated with the 24 V (AC) power supply unit provided. Do not use an adapter.

Protect the 24 V (AC) power supply unit from moisture and direct sunlight when connected.

Install the irrigation control in a weatherproof location.

Check the power cord for damage before use.

The product must be used only for controlling commercially available 24 V (AC) valves. The electric power consumption per channel must not exceed 400 mA (a GARDENA Irrigation Valve Art. 1278 requires 150 mA).

Cable cross-section of the connection cable:

The maximum permissible distance between the product and the valve depends on the cross-section of the connection cable. For a distance of 30 m, the cross section is 0.5 mm² and 0.75 mm² for a distance of 45 m. No more than 3 valves must be in operation at the same time.

The **GARDENA Connection Cable Art. 1280** is 0.5 mm² in size and is 15 m long.

Up to 6 valves can be connected using this cable. The connection cable can be connected so that it is watertight using the **GARDENA Cable Clip Art. 1282**.

Personal safety



DANGER!

Risk of suffocation!

Small parts can be easily swallowed. There is also a risk that the polybag can suffocate toddlers. Keep toddlers away when you assemble the product.

Protect the product from direct sunlight.



Be careful when touching the valves!

Metal parts can heat up.

2. ASSEMBLY

To assemble the irrigation control on the wall:

The both screws and dowels are in the scope of delivery.

The distance between the holes is 120 mm.

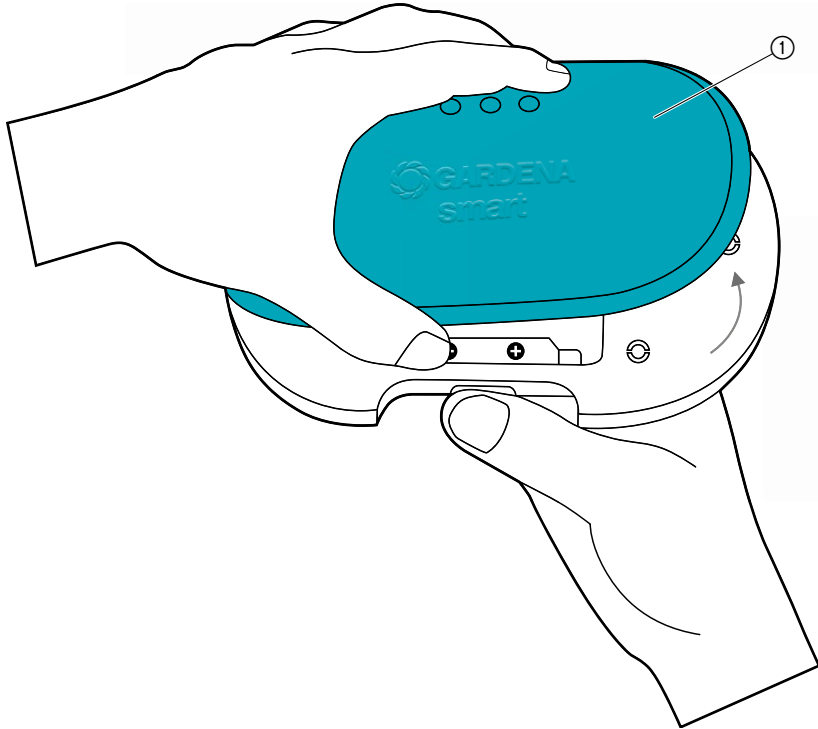

1. Remove the cover ①.

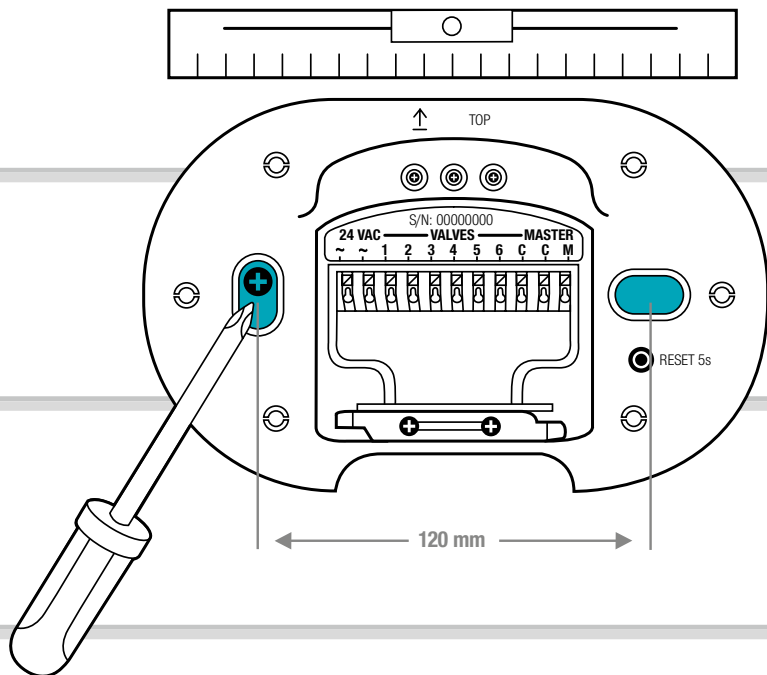

2. Mark the positions of the holes. To do this, hold the Irrigation Control against the wall, bring it straight and mark 2 holes at a distance of 120 mm.
3. Drill the holes and assemble the Irrigation Control to the wall with the 2 plugs and screws supplied.

NOTE:

The cables must be led downwards!

Pay attention to the cable lengths, especially during initial installation.

If you want to mount several irrigation controls, the distance between the holes is 150 mm.

Due to the cable routing, up to 3 Irrigation Controls can be assembled on top of each other.

3. INSTALLATION

To remove the cable strain relief:

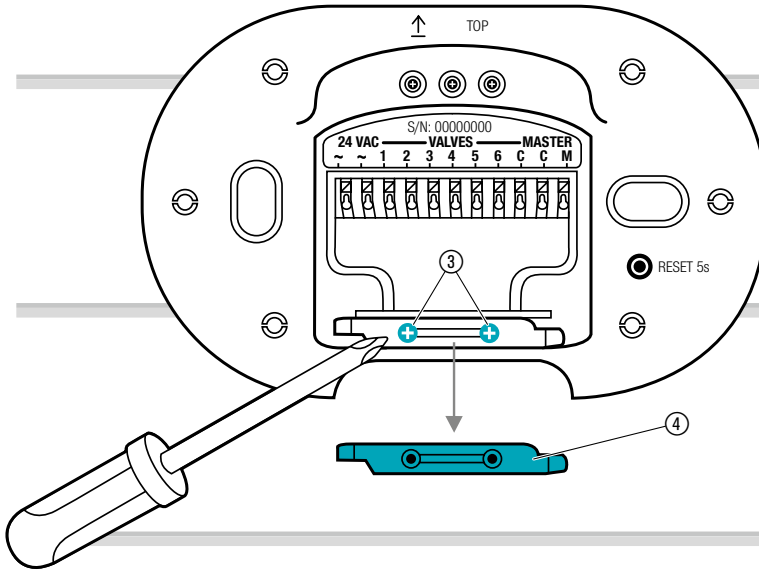

→ Loosen both screws ③ and remove the cable strain relief ④.

Connection overview:

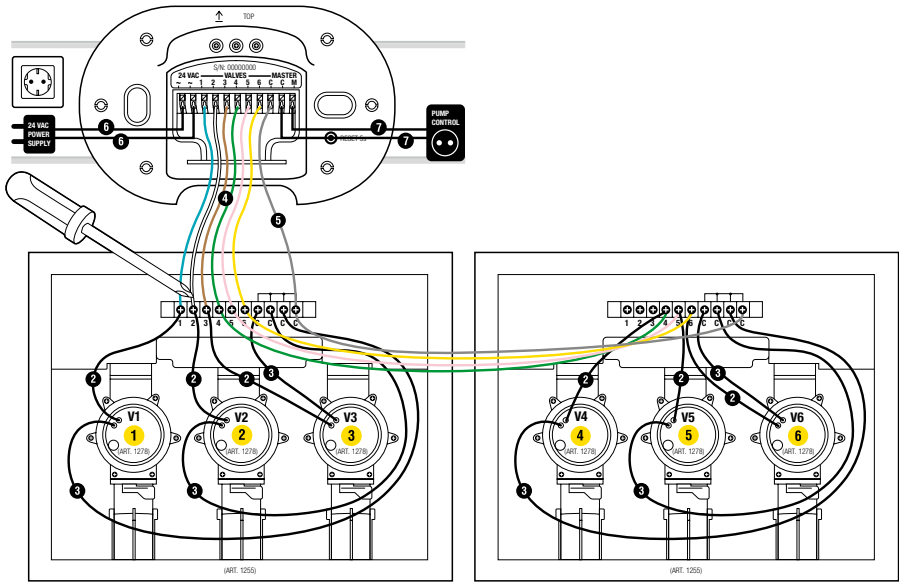

Valve Box Art. 1255

Valve Box Art. 1255

To connect the valves to the Valve Box:

Make sure that the terminal block has been correctly installed in the valve box.

1

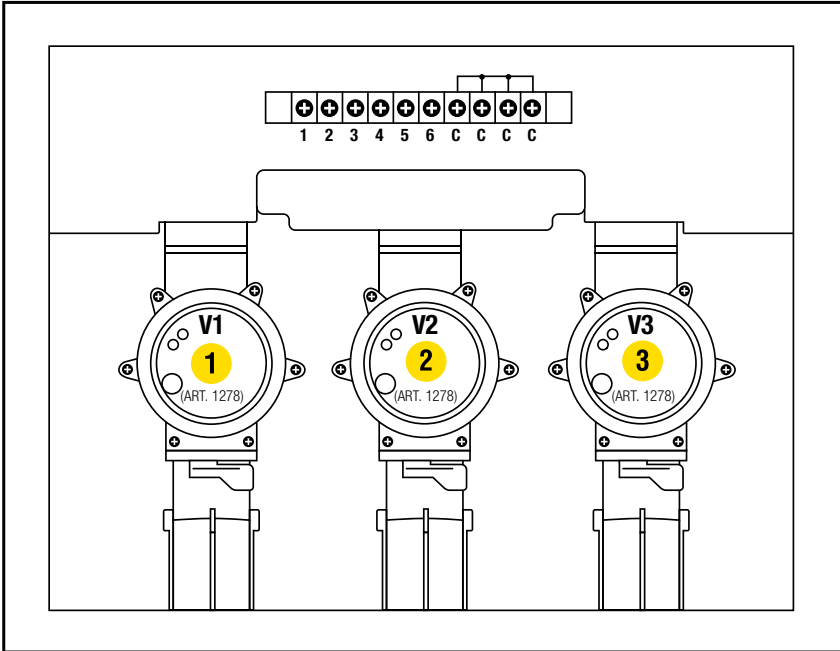

→ Label the valves (1 – 6) with the yellow stickers of the valve box.
 (Therefore the signal cable terminals **VALVES 1 – 6** of the Irrigation Control can be clearly assigned to the valves).

2

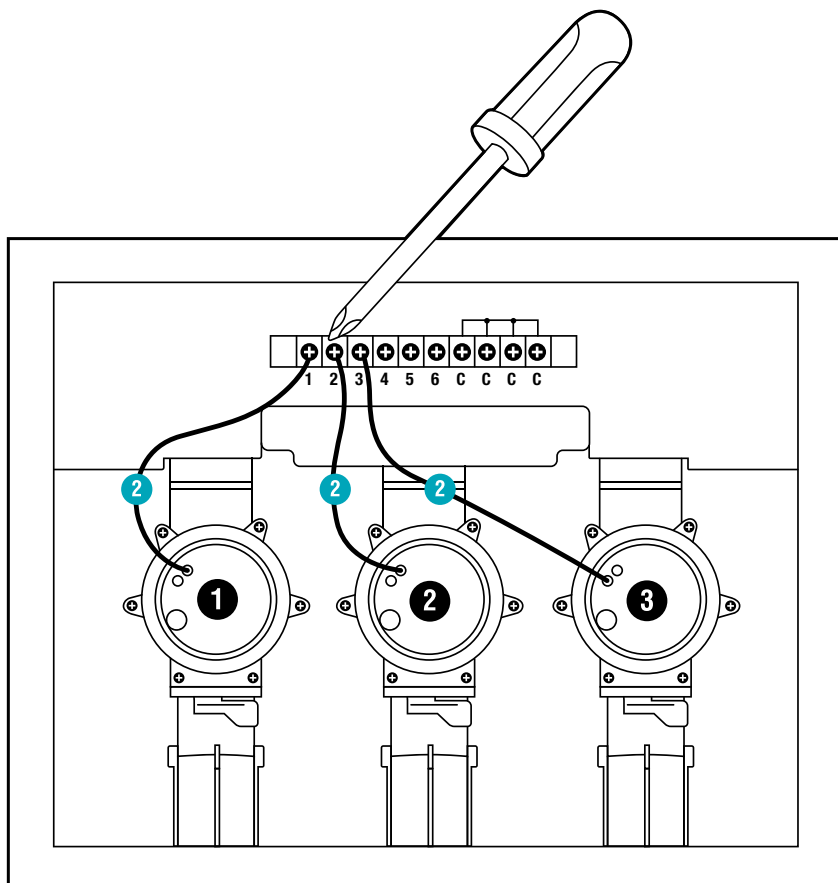

- Connect a cable of the valve **V1** to the signal cable terminal **1** of the Valve Box.
- Connect a cable of the valve **V2** to the signal cable terminal **2** of the Valve Box.
- Connect a cable of the valve **V3** to the signal cable terminal **4** of the Valve Box.

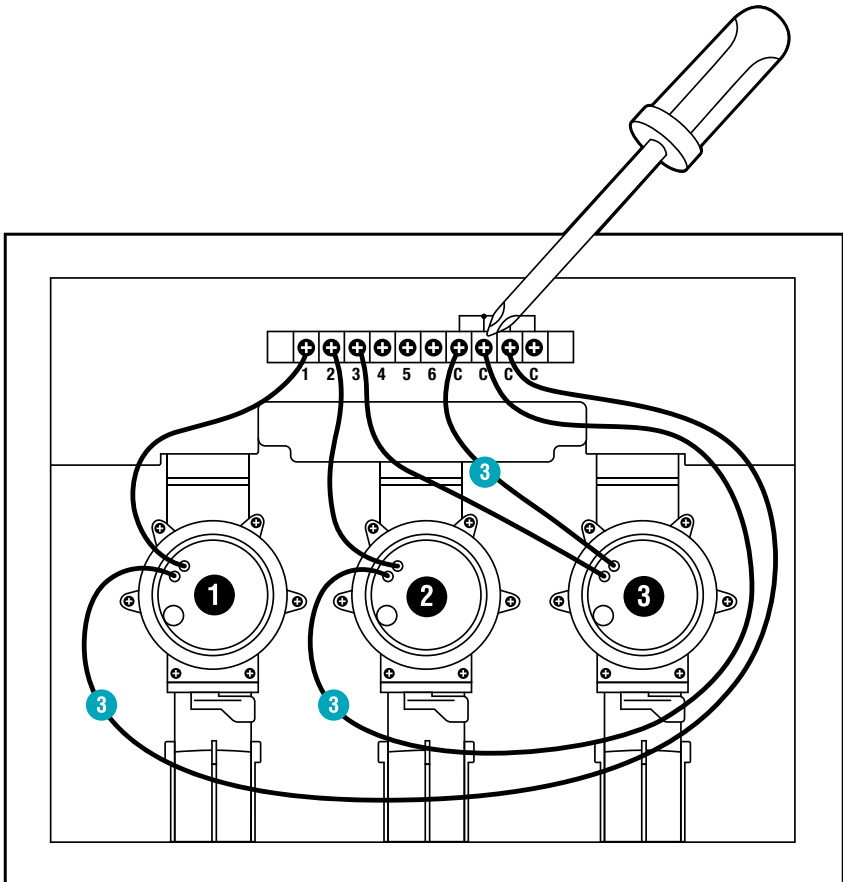

- Connect the other cable of the valve **V1** to a signal cable terminal **C** of the Valve Box.
(All 4 signal cable terminals **C** are connected to each other and equivalent).
- Connect the other cable of the valve **V2** to a signal cable terminal **C** of the Valve Box.
- Connect the other cable of the valve **V3** to a signal cable terminal **C** of the Valve Box.

To connect the Valve Box to the Irrigation Control:

Tip: Press down the signal cable terminal with your index finger, screwdriver or ballpoint pen to connect the cables.

With the **GARDENA Connection Cable Art. 1280** you can connect up to **6 valves** with the Irrigation Control.

4

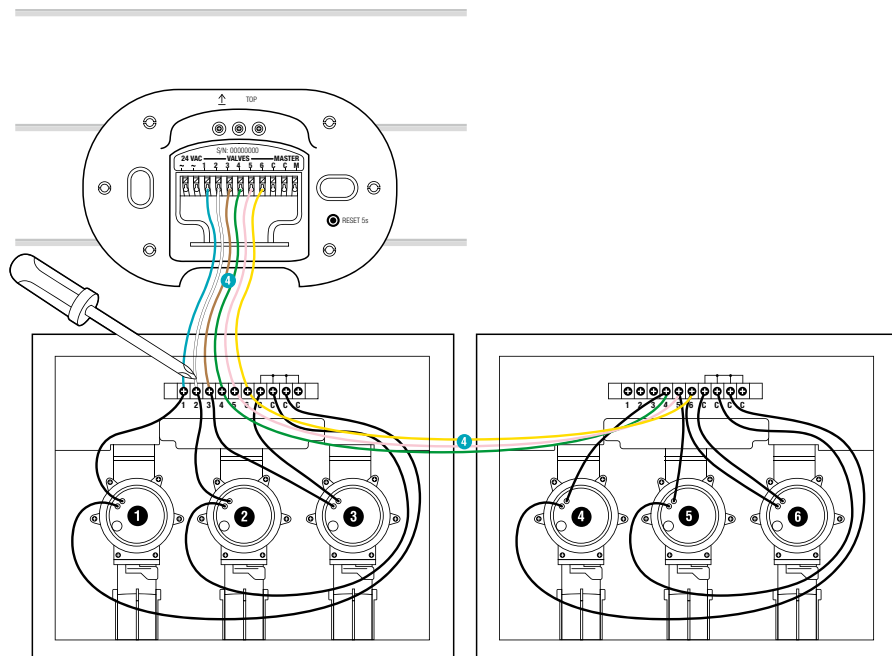

- Connect the signal cable terminal **1** of the Valve Box to the signal cable terminal **VALVES 1** of the Irrigation Control.
- Connect the signal cable terminal **2** of the Valve Box to the signal cable terminal **VALVES 2** of the Irrigation Control.
- Connect the signal cable terminal **3** of the Valve Box to the signal cable terminal **VALVES 3** of the Irrigation Control.

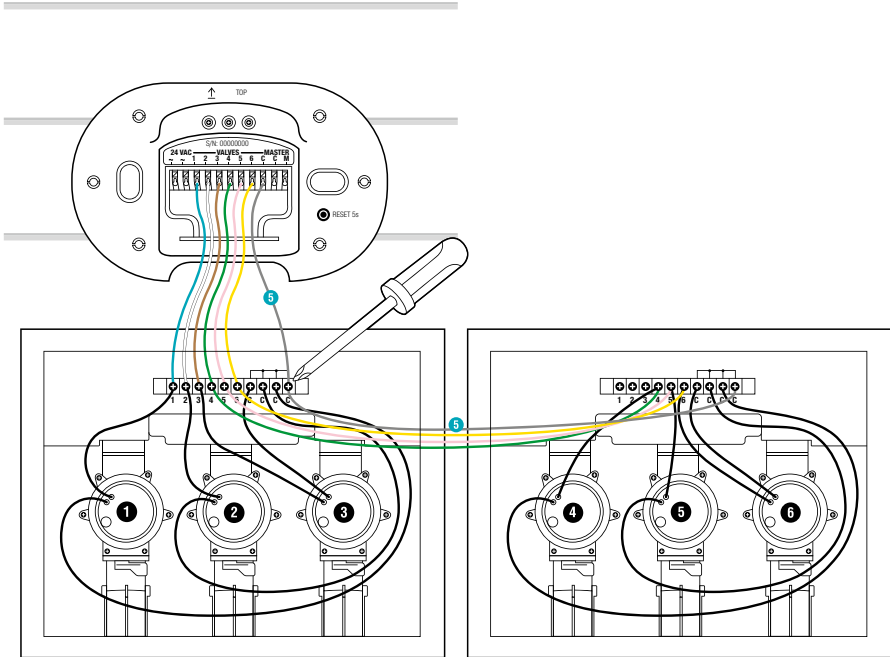

→ Connect one signal cable terminal **C** of the Valve Box to the blue signal signal cable terminal **C** of the Irrigation Control.

To connect the pump:

Master Channel:

The master channel **M** is activated as soon as a valve is activated.

For example, you can activate a garden pump via the master channel so that the pump supplies the irrigation system whenever a valve is activated.

For example, the pump can be operated using the **GARDENA Pump Control Art. 1273** that is connected to the master channel.

6

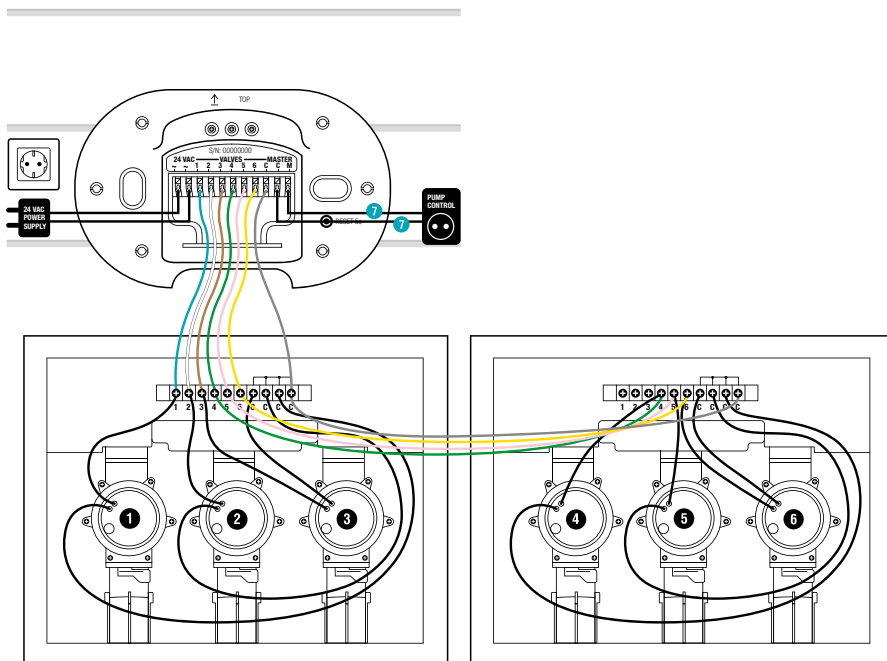

→ Connect both cables to the signal cable terminals **M** and **C** of the Irrigation Control (polarity does not have to be considered).

To connect the power supply:



CAUTION!

The irrigation control is damaged if the power supply unit is connected to cable terminals other than the 24 V (AC) cable terminals!

→ Connect the power supply unit to the 24 V (AC) terminals only!



CAUTION!

Damaging of the irrigation control system by short circuit!

→ Check all wiring before you plug in the power supply.

7

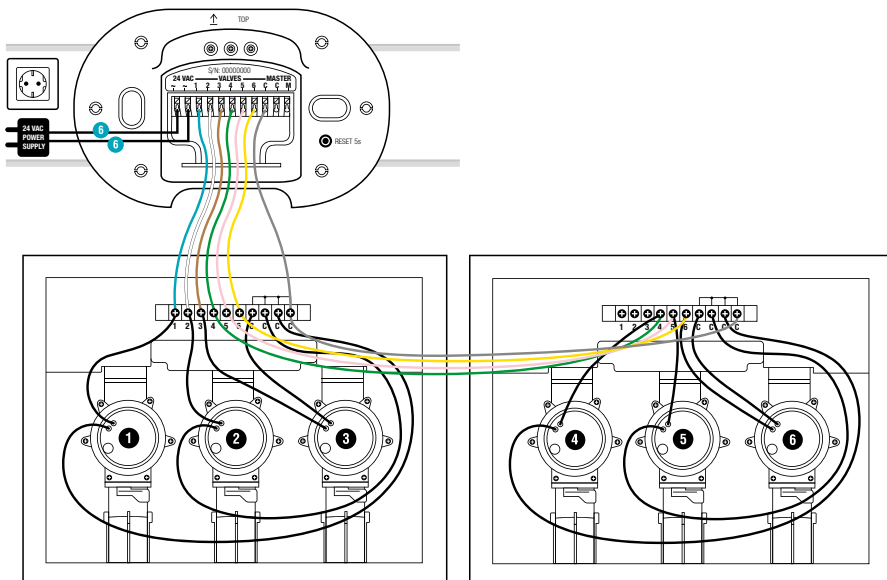

1. Connect both cables to the cable terminals **24 V (AC)** of the Irrigation Control (polarity does not have to be considered).
2. Plug the power supply unit into an socket.

To close the cover:

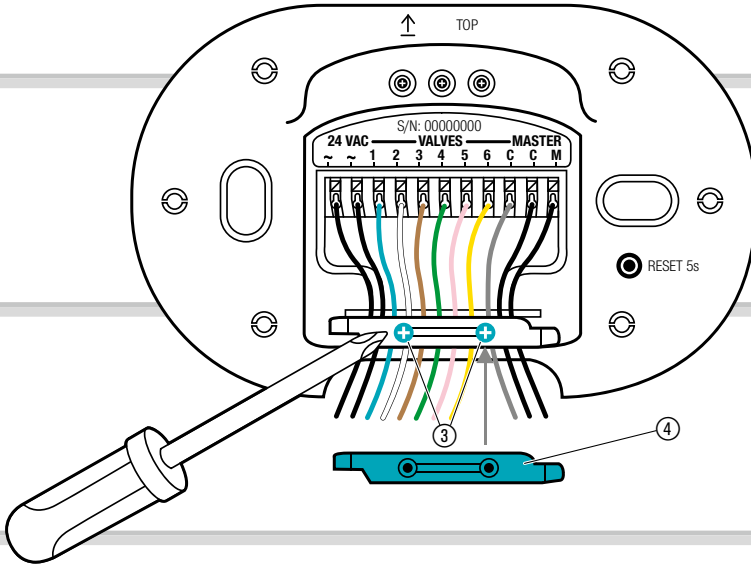

1. Attach the cable strain relief ④ and tighten the two screws ③.

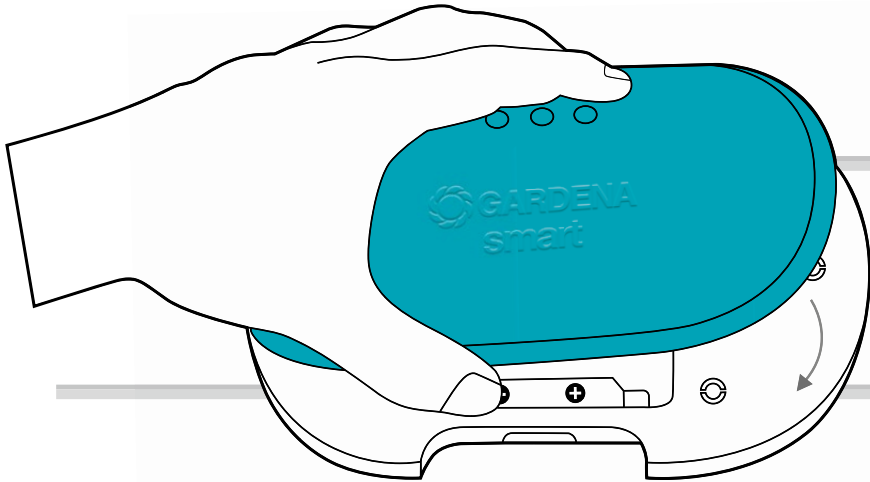

2. Push the cover onto the Irrigation Control.

4. OPERATION

LED Display:

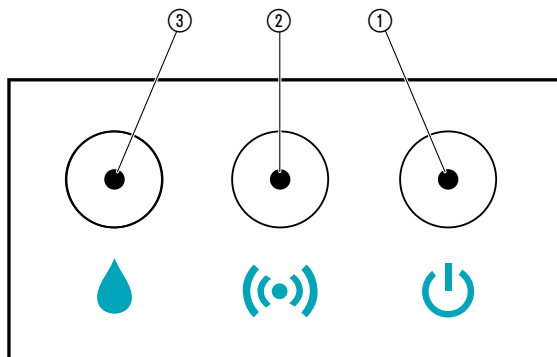

- ① **LED Power:**
Green: Power On
- ② **LED Connection display/Signal:**
Green flashing: While connecting
Green: Signal strength high
Yellow: Signal strength medium
Red: Signal strength low
Red flashing: Inclusion mode failed
- ③ **LED Active watering:**
Green

Operation with the GARDENA smart system App:

You can use the **GARDENA smart system app** to control all smart system products from anywhere at any time. You can download the free **GARDENA smart system app** from the Apple App Store or from the Google Play Store.

In order to include, a **GARDENA smart Gateway** with internet connectivity is needed. All GARDENA smart products are integrated via the app. Follow the instructions inside the App.

Settings of the Irrigation Control:

- According to the timings in the smart system App:
Watering days, start, duration
- As required in the smart system App:
Start and finish

Factory Reset:

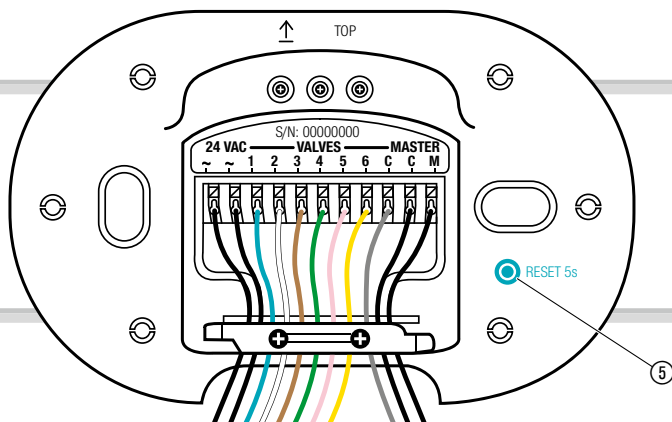

The smart Irrigation Control will be reset to the factory settings.

→ Push the Reset key ⑤ for a short time.
New connection.

- or -

→ Push and hold down the Reset key ⑤ for at least 5 seconds.
 Cancels the existing connection and allows a new connection to be established, e. g. different Gateway.

5. MAINTENANCE

To clean the Irrigation Control:

Do not use caustic / abrasive cleaning agents.

→ Clean the Irrigation Control with a damp cloth (do not use solvent).

6. STORAGE

To put into storage:

The product must be stored away from children.

→ Do not store the Irrigation Control outdoors if not in use.

Disposal:

(in accordance with RL2012/19/EC)





The product must not be disposed of to normal household waste. It must be disposed of in line with local environmental regulations.

IMPORTANT!

Dispose of the product through or via your municipal recycling collection centre.

7. TROUBLESHOOTING

Problem	Possible Cause	Remedy
 LED Power illuminates red	Undervoltage	→ Check the power connection.
	Wrong power supply.	→ Check the power supply.
	MCU Communication error.	→ Reset the irrigation control to factory settings.
 LED Active Watering flashes red	Can't open valve because of limit of 2.	→ Check the program.
	Valve is not connected.	→ Check the valve.
	Single channel overcurrent.	→ Check the current of the channel.
	Sum overcurrent.	→ Check the sum current of the valves.
	Watering schedule cancelled.	→ Restart the program.
	Master channel error	→ Check the master channel.
	Watering duration too short.	→ Increase the watering duration
Watering program is not being undertaken (no watering)	The valve has previously been manually opened.	→ Avoid any program overlap.
	Water tap closed.	→ Open the water tap.
No function	Faulty wiring.	→ Check the cable terminals.
	Power supply unit is not connected.	→ Connect the power supply unit.
	Power supply unit is too hot.	→ Disconnect the power supply unit and let it be cooled down. Connect the power supply unit again. → Protect the power supply unit from direct sunlight.
Inclusion is not possible (Inclusion)	No wireless connection to the Gateway.	→ Select another position for the irrigation control or the Gateway.
	No power supply available.	→ Check the mains cable.

Problem	Possible Cause	Remedy
Irrigation Control does not respond	Faulty wiring.	→ Check the cable terminals.
	No wireless connection to the Gateway.	→ Check the wireless connection to the Gateway.



NOTE: For any other malfunctions please contact the GARDENA service department. Repairs must only be done by GARDENA service departments or specialist dealers approved by GARDENA.

8. TECHNICAL DATA

	Unit	Value (Art. 19032)
Operation temperature range (outdoors)	°C	+5 – +40
<i>SRD:</i>		
Frequency range	MHz	863 – 870
Maximum power	mW	25
Free field radio range (approx.)	m	100
<i>Power supply</i>		
Mains voltage	V (AC)	230
Mains frequency	Hz	50
Rated Power	W	22
Standby power (approx.)	W	3
Output voltage	V (AC)	24
Max. Output current	mA	600

EC Declaration of Conformity:

Hereby, GARDENA Manufacturing GmbH declares that the radio equipment type (smart Irrigation Control Art. 19032) is in compliance with directive 2014/53/EU.

The full text of the EC declaration of conformity is available at the following internet address:

<http://www.gardena.com/int/support/safety-regulations>

9. ACCESSORIES

GARDENA Pump Control	Art. 1273
GARDENA Watering Valve 24V	Art. 1278
GARDENA Valve Boxes	Art. 1254/1255
GARDENA Connection Cable	Art. 1280
GARDENA Cable Clips	Art. 1282

10. SERVICE/WARRANTY

Service:

Please contact the address on the back page.

Warranty:

In the event of a warranty claim, no charge is levied to you for the services provided.

GARDENA Manufacturing GmbH offers a 2-year warranty for this product (from the date of purchase) if the product has been used exclusively for private purposes. This manufacturer's warranty does not apply to used products purchased from a secondary market. This warranty includes all significant defects of the product that can be proved to be material or manufacturing faults. This warranty is fulfilled by supplying a fully functional replacement product or by repairing the faulty product sent to us free of charge; we reserve the right to choose between these options. This service is subject to the following provisions:

- The product was used for its intended purpose as per the recommendations in the operating instructions.
- Neither the purchaser nor a third party has attempted to repair the product.
- Only original GARDENA spare and wear parts were used.

Normal wear and tear of parts and components, optical changes, as well as wear parts and consumables, are excluded from the warranty.

This manufacturer's warranty does not affect warranty entitlements against the dealer/retailer.

If problems arise with this product, please contact our Service department. In the event of a warranty claim, please send the defective product together with a copy of the purchase receipt and a description of the defect, sufficiently stamped, to the GARDENA service address on the back page.

Product liability:

In accordance with the German Product Liability Act, we hereby expressly declare that we accept no liability for damage incurred from our products where said products have not been properly repaired by a GARDENA approved service partner or where original GARDENA parts or parts authorised by GARDENA were not used.

