

EasyCut Li

Art. 9836

<b>DE Betriebsanleitung</b> Akku-Heckenschere	<b>SK Návod na obsluhu</b> Akumulátorové nožnice na živý plot
<b>EN Operator's manual</b> Battery Hedge Trimmer	<b>EL Οδηγίες χρήσης</b> Μπορντούροφάλιδο μπαταρίας
<b>FR Mode d'emploi</b> Taille-haies à batterie	<b>RU Инструкция по эксплуатации</b> Аккумуляторный кусторез
<b>NL Gebruiksaanwijzing</b> Accu-heggenschaar	<b>SL Navodilo za uporabo</b> Akumulatorske škarje za živo mejo
<b>SV Bruksanvisning</b> Accu-häcksax	<b>HR Upute za uporabu</b> Baterijske škare za živicu
<b>DA Brugsanvisning</b> Hækkeklipper med accu	<b>SR/ BS Uputstvo za rad</b> Baterijske makaze za živicu
<b>FI Käyttöohje</b> Akkukäyttöinen pensasleikkuri	<b>UK Інструкція з експлуатації</b> Акумуляторний садовий секатор
<b>NO Bruksanvisning</b> Accu hekksaks	<b>RO Instrucțiuni de utilizare</b> Trimmer de gard viu cu baterie
<b>IT Istruzioni per l'uso</b> Tagliasiepi a batteria	<b>TR Kullanma Kılavuzu</b> Akülü çit budayıcı
<b>ES Instrucciones de empleo</b> Recortasetos con Accu	<b>BG Инструкция за експлоатация</b> Аккумуляторна ножица за жив плет
<b>PT Manual de instruções</b> Corta sebes a bateria	<b>SQ Manual përdorimi</b> Prerëse ligustrash me bateri
<b>PL Instrukcja obsługi</b> Akumulatorowe nożyce do żywopłotu	<b>ET Kasutusjuhend</b> Akuga hekilõikur
<b>HU Használati utasítás</b> Akumulátoros sövénynyíró	<b>LT Eksploatavimo instrukcija</b> Akumuliatorinės gyvatvorių žirklys
<b>CS Návod k obsluze</b> Akumulátorové nůžky na živý plot	<b>LV Lietošanas instrukcija</b> Ar akumulatoru darbināmas dzīvžoga šķēres

<p><b>DE Produkthaftung</b> Wir weisen ausdrücklich darauf hin, dass wir in Übereinstimmung mit dem Produkthaftungsgesetz nicht für Schäden haften, die durch unsere Produkte entstehen, wenn diese unsachgemäß und nicht durch einen von uns autorisierten Servicepartner repariert wurden oder wenn keine Original GARDENA Teile oder von uns zugelassene Teile verwendet wurden.</p>
<p><b>EN Product liability</b> In accordance with the German Product Liability Act, we hereby expressly declare that we accept no liability for damage incurred from our products where said products have not been properly repaired by a GARDENA-approved service partner or where original GARDENA parts or parts authorised by GARDENA were not used.</p>
<p><b>FR Responsabilité</b> Conformément à la loi relative à la responsabilité du fait des produits défectueux, nous déclarons expressément par la présente que nous déclinons toute responsabilité pour les dommages résultant de nos produits, si lesdits produits n'ont pas été correctement réparés par un partenaire d'entretien agréé GARDENA ou si des pièces d'origine GARDENA ou des pièces agréées GARDENA n'ont pas été utilisées.</p>
<p><b>NL Productaansprakelijkheid</b> Conform de Duitse wet inzake productaansprakelijkheid verklaren wij hierbij uitdrukkelijk dat wij geen aansprakelijkheid aanvaarden voor schade ontstaan uit onze producten waarbij deze producten niet zijn gerepareerd door een GARDENA-erkende servicepartner of waarbij geen originele GARDENA-onderdelen of onderdelen die door GARDENA zijn goedgekeurd zijn gebruikt.</p>
<p><b>SV Produktansvar</b> I enlighet med tyska produktansvarslagar förklarar vi härmed uttryckligen att vi inte åtar oss något ansvar för skador som orsakas av våra produkter där produkterna inte har genomgått korrekt reparation från en GARDENA-godkänd servicepartner eller där originaldelar från GARDENA eller delar godkända av GARDENA inte använts.</p>
<p><b>DA Produktansvar</b> I overensstemmelse med den tyske produktansvarslov erklærer vi hermed udtrykkeligt, at vi ikke påtager os noget ansvar for skader på vores produkter, hvis de pågældende produkter ikke er blevet repareret korrekt af en GARDENA-godkendt servicepartner, eller hvor der ikke er brugt originale GARDENA-reservedele eller godkendte reservedele fra GARDENA.</p>
<p><b>FI Tuotevastuu</b> Saksan tuotevastuulain mukaisesti emme ole vastuussa laitteiden vaurioista, jos korjauksia ei ole tehnyt GARDENA:n hyväksymä huoltoliike tai jos niiden synnä on muiden kuin alkuperäisten GARDENA-varaosien tai GARDENA:n hyväksymien varaosien käyttö.</p>
<p><b>IT Responsabilità del prodotto</b> In conformità con la Legge tedesca sulla responsabilità del prodotto, con la presente dichiariamo espressamente che decliniamo qualsiasi responsabilità per danni causati dai nostri prodotti qualora non siano stati correttamente riparati presso un partner di assistenza approvato GARDENA o laddove non siano stati utilizzati ricambi originali o autorizzati GARDENA.</p>
<p><b>ES Responsabilidad sobre el producto</b> De acuerdo con la Ley de responsabilidad sobre productos alemana, por la presente declaramos expresamente que no aceptamos ningún tipo de responsabilidad por los daños ocasionados por nuestros productos si dichos productos no han sido reparados por un socio de mantenimiento aprobado por GARDENA o si no se han utilizado piezas originales GARDENA o piezas autorizadas por GARDENA.</p>
<p><b>PT Responsabilidade pelo produto</b> De acordo com a lei alemã de responsabilidade pelo produto, declaramos que não nos responsabilizamos por danos causados pelos nossos produtos, caso os tais produtos não tenham sido devidamente reparados por um parceiro de assistência GARDENA aprovado ou se não tiverem sido utilizadas peças GARDENA originais ou peças autorizadas pela GARDENA.</p>
<p><b>PL Odpowiedzialność za produkt</b> Zgodnie z niemiecką ustawą o odpowiedzialności za produkt, niniejszym wyraźnie oświadczamy, że nie ponosimy żadnej odpowiedzialności za szkody poniesione na skutek użytkowania naszych produktów, w przypadku gdy naprawa tych produktów nie była odpowiednio przeprowadzana przez zatwierdzonego przez firmę GARDENA partnera serwisowego lub nie stosowano oryginalnych części GARDENA albo części autoryzowanych przez tę firmę.</p>
<p><b>HU Termékszavatosság</b> A németországi termékszavatossági törvénnyel összhangban ezennel nyomatékosan kijelentjük, hogy nem vállalunk felelősséget a termékeinkben keletkezett olyan károkért, amelyek valamely GARDENA által jóváhagyott szervizpartner által nem megfelelően végzett javításból adódtak, vagy amely során nem eredeti GARDENA alkatrészeket vagy a GARDENA által jóváhagyott alkatrészeket használtak fel.</p>
<p><b>CS Odpovědnost za výrobek</b> V souladu s německým zákonem o odpovědnosti za výrobek tímto výslovně prohlašujeme, že nepřijímáme žádnou odpovědnost za poškození vzniklá na našich výrobcích, kdy zmíněné výrobky nebyly řádně opraveny schváleným servisním partnerem GARDENA nebo kdy nebyly použity originální náhradní díly GARDENA nebo náhradní díly autorizované společností GARDENA.</p>
<p><b>SK Zodpovednosť za produkt</b> V súlade s nemeckými právnymi predpismi upravujúcimi zodpovednosť za výrobok týmto výslovné prehlasujeme, že nenesieme žiadnu zodpovednosť za škody spôsobené našimi výrobkami, v prípade ktorých neboli náležité opravy vykonané servisným partnerom schváleným spoločnosťou GARDENA alebo neboli použité diely spoločnosti GARDENA alebo diely schválené spoločnosťou GARDENA.</p>
<p><b>EL Ευθύνη προϊόντος</b> Σύμφωνα με τον γερμανικό νόμο περί Ευθύνης για τα Προϊόντα, με το παρόν δηλώνουμε ρητώς ότι δεν αποδεχόμαστε καμία ευθύνη για τυχόν ζημιές που προκύπτουν από τα προϊόντα μας εάν αυτά δεν έχουν επισκευαστεί σωστά από κάποιον συγκεκριμένο συνεργάτη επισκευών της GARDENA ή εάν δεν έχουν χρησιμοποιηθεί αυθεντικά εξαρτήματα GARDENA ή εξαρτήματα συγκεκριμένα από την GARDENA.</p>
<p><b>SL Odgovornost proizvajalca</b> V skladu z nemškimi zakoni o odgovornosti za izdelke, izrecno izjavljajo, da ne sprejemamo nobene odgovornosti za škodo, ki jo povzročijo naši izdelki, če teh niso ustrezno popravili GARDENINI odobreni servisni partnerji ali pri tem niso bili uporabljeni originalni GARDENINI nadomestni deli ali GARDENINIMI homologiranimi nadomestnimi deli.</p>
<p><b>HR Pouzdanost proizvoda</b> Sukladno njemačkom zakonu o pouzdanosti proizvoda, ovime izričito izjavljujemo kako ne prihvaćamo nikakvu odgovornost za oštećenja na našim proizvodima nastala uslijed neispravnog popravka od strane servisnog partnera kojeg odobrava GARDENA ili uslijed nekorištenja originalnih GARDENA dijelova ili dijelova koje odobrava GARDENA.</p>
<p><b>RO Răspunderea pentru produs</b> În conformitate cu Legea germană privind răspunderea pentru produs, declarăm în mod expres prin prezentul document că nu acceptăm nicio răspundere pentru defecțiunile suferite de produsele noastre atunci când acestea nu au fost reparate în mod corect de un atelier de service partener, aprobat de GARDENA, sau când nu au fost utilizate piese GARDENA originale sau piese autorizate de GARDENA.</p>
<p><b>BG Отговорност за вреди, причинени от стоки</b> Съгласно германския Закон за отговорността за вреди, причинени от стоки, с настоящото изрично декларираме, че не носим отговорност за щети, причинени от нашите продукти, ако те не са били правилно ремонтирани от одобрен от GARDENA сервиз или ако не са използвани оригинални части на GARDENA или части, одобрени от GARDENA.</p>
<p><b>ET Tootevastutus</b> Vastavalt Saksamaa tootevastutusseadusele deklareerime käesolevaga selgesõnaliselt, et me ei kanna mingisugust vastutust meie toodetest tingitud kahjude eest, kui need tooted ei ole korrektselt parandatud GARDENA heakskiidetud hoolduspartneri poolt või kui parandamisel ei ole kasutatud GARDENA originaalosi või GARDENA volitatud osi.</p>
<p><b>LT Gaminio patikimumas</b> Mes aiškiai pareiškiame, kad, atsižvelgiant į Vokietijos gaminių patikimumo įstatymą, nepriisiame atsakomybės dėl bet kokios žalos, patirtos dėl mūsų gaminių, jeigu jie buvo netinkamai taisomi arba jų dalys buvo pakeistos neoriginaliomis GARDENA dalimis ar nepatvirtintomis dalimis, arba jeigu remonto darbai buvo atliekami ne GARDENA techninės priežiūros centro specialistų.</p>
<p><b>LV Atbildība par produkcijas kvalitāti</b> Saskaņā ar Vācijas likumu par atbildību par produkcijas kvalitāti ar šo mēs paziņojam, ka neuzņemamies atbildību par bojājumiem, kas radušies, lietojot mūsu izstrādājumus, kuru remontu nav veicis uzņēmuma GARDENA apstiprināts apkopes partneris vai kuru remontam netika izmantotas oriģinālās GARDENA detaļas vai detaļas, kuru lietošanu apstiprinājis uzņēmums GARDENA.</p>

01

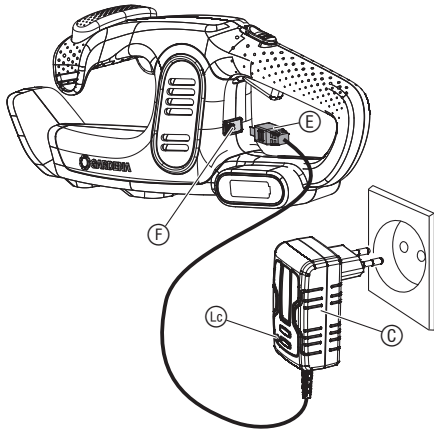

02

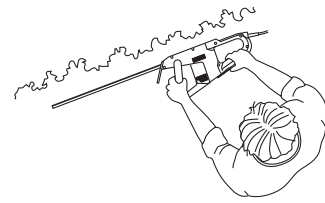

03

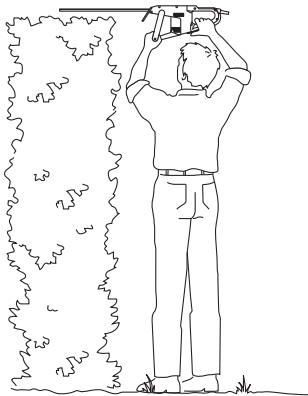

04

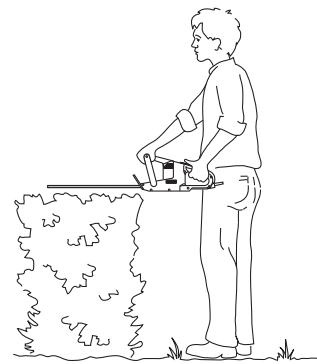

05

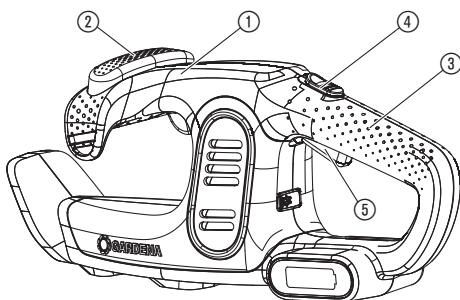

M1

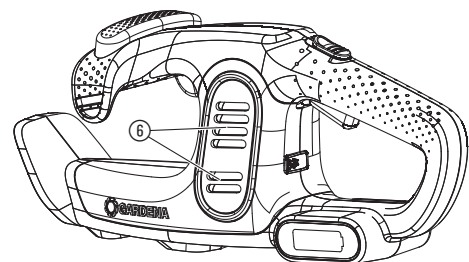

## EN

### Original instructions.



This product is not intended for use by persons (including children) with reduced physical, sensory or mental capabilities, or lack of experience and knowledge, unless they have been given supervision or instruction concerning use of the product by a person responsible for their safety. Children should be supervised to ensure that they do not play with the product. The use of this product by young people under the age of 16 is not recommended.

### Intended use:

The GARDENA Hedge Trimmer is intended to cut hedges, shrubs and grass coverings in private domestic gardens and allotments.

The product is not intended for long term use.

### DANGER! Risk of injury!

**Do not use the product to cut lawns/lawn edges, to chop up material or to make compost.**

## 1. SAFETY

### IMPORTANT!

Read the operator's manual carefully before use and keep for future reference.

#### Symbols on the product:



Read operator's manual.



Always wear approved hearing protection.  
Always wear approved eye protection.



Danger – Keep hands away from blade.



Do not expose to rain.



**For the charger:**  
Remove plug from the mains immediately if the cable is damaged or cut.

#### General safety warnings

#### General power tool safety warnings:



**WARNING!**

**Read all safety warnings and all instructions!** Failure to follow the warnings and instructions may result in electric shock, fire and/or serious injury.

**Save all warnings and instructions for future reference.**

The term "power tool" in the warnings refers to your mains operated (corded) power tool or battery operated (cordless) power tool.

#### 1) Work area safety

a) **Keep work area clean and well lit.** Cluttered or dark areas invite accidents.

- b) **Do not operate power tools in explosive atmospheres, such as in the presence of flammable liquids, gases or dust.** *Power tools create sparks which may ignite the dust or fumes.*
- c) **Keep children and bystanders away while operating a power tool.** *Distractions can cause you to lose control.*
- 2) Electrical safety**
- a) **Power tool plugs must match the outlet. Never modify the plug in any way. Do not use any adaptor plugs with earthed (grounded) power tools.** *Unmodified plugs and matching outlets will reduce risk of electric shock.*
- b) **Avoid body contact with earthed or grounded surfaces, such as pipes, radiators, ranges and refrigerators.** *There is an increased risk of electric shock if your body is earthed or grounded.*
- c) **Do not expose power tools to rain or wet conditions.** *Water entering a power tool will increase the risk of electric shock.*
- d) **Do not abuse the cord. Never use the cord for carrying, pulling or unplugging the power tool. Keep cord away from heat, oil, sharp edges or moving parts.** *Damaged or entangled cords increase the risk of electric shock.*
- e) **When operating a power tool outdoors, use an extension cord suitable for outdoor use.** *Use of a cord suitable for outdoor use reduces the risk of electric shock.*
- f) **If operating a power tool in a damp location is unavoidable, use a residual current device (RCD) protected supply.** *Use of an RCD reduces the risk of electric shock.*
- 3) Personal safety**
- a) **Stay alert, watch what you are doing and use common sense when operating a power tool. Do not use a power tool while you are tired or under the influence of drugs, alcohol or medication.** *A moment of inattention while operating power tools may result in serious personal injury.*
- b) **Use personal protective equipment. Always wear eye protection.** *Protective equipment such as dust mask, non-skid safety shoes, hard hat, or hearing protection used for appropriate conditions will reduce personal injuries.*
- c) **Prevent unintentional starting. Ensure the switch is in the off-position before connecting to power source and/or battery pack, picking up or carrying the tool.** *Carrying power tools with your finger on the switch or energising power tools that have the switch on invites accidents.*
- d) **Remove any adjusting key or wrench before turning the power tool on.** *A wrench or a key left attached to a rotating part of the power tools may result in personal injury.*
- e) **Do not overreach. Keep proper footing and balance at all times.** *This enables better control of the power tool in unexpected situations.*
- f) **Dress properly. Do not wear loose clothing or jewellery. Keep your hair, clothing and gloves away from moving parts.** *Loose clothes, jewellery or long hair can be caught in moving parts.*
- g) **If devices are provided for the connection of dust extraction and collection facilities, ensure these are connected and properly used.** *Use of dust collection can reduce dust-related hazards.*
- 4) Power tool use and care**
- a) **Do not force the power tool. Use the correct power tool for your application.** *The correct power tool will do the job better and safer at the rate for which it was designed.*
- b) **Do not use the power tool if the switch does not turn it on and off.** *Any power tool that cannot be controlled with the switch is dangerous and must be repaired.*
- c) **Disconnect the plug from the power source and /or the battery pack from the power tool before making any adjustments, changing accessories, or storing power tools.** *Such preventive safety measures reduce the risk of starting the power tool accidentally.*
- d) **Store idle power tools out of the reach of children and do not allow persons unfamiliar with the power tool or these instructions to operate the power tool.** *Power tools are dangerous in the hands of untrained users.*
- e) **Maintain power tools. Check for misalignment or binding of moving parts, breakage of parts and any other condition that may affect the power tool's operation. If damaged, have the power tool repaired before use.** *Many accidents are caused by poorly maintained power tools.*
- f) **Keep cutting tools sharp and clean.** *Properly maintained cutting tools with sharp cutting edges are less likely to bind and are easier to control.*
- g) **Use the power tool, accessories and tool bits etc. in accordance with these instructions, taking into account the working conditions and the work to be performed.** *Use of the power tool for operations different from those intended could result in a hazardous situation.*
- 5) Battery tool use and care**
- a) **Recharge only with the charger specified by the manufacturer.** *A charger that is suitable for one type of battery pack may create a risk of fire when used with another battery pack.*
- b) **Use power tools only with specifically designated battery packs.** *Use of any other battery packs may create a risk of injury and fire.*
- c) **When battery pack is not in use, keep it away from other metal objects, like paper clips, coins, keys, nails, screws or other small metal objects, that can make a connection from one terminal to another.** *Shorting the battery terminals together may cause burns or a fire.*

- d) **Under abusive conditions, liquid may be ejected from the battery; avoid contact. If contact accidentally occurs, flush with water. If liquid contacts eyes, additionally seek medical help.** *Liquid ejected from the battery may cause irritation or burns.*

## 6) Service

**Have your power tool serviced by a qualified repair person using only identical replacement parts.**

*This will ensure that the safety of the power tool is maintained.*

### Hedge trimmer safety warnings:

- **Keep all parts of the body away from the cutter blade. Do not remove cut material or hold material to be cut when blades are moving. Make sure the switch is off when clearing jammed material.** *A moment of inattention while operating the hedge trimmer may result in serious personal injury.*
- **Carry the hedge trimmer by the handle with the cutter blade stopped. When transporting or storing the hedge trimmer always fit the cutting device cover.** *Proper handling of the hedge trimmer will reduce possible personal injury from the cutter blades.*
- **Hold the power tool by insulated gripping surfaces only, because the cutter blade may contact hidden wiring or its own cord.** *Cutter blades contacting a "live" wire may make exposed metal parts of the power tool "live" and could give the operator an electric shock.*
- **Keep cable away from the cutting area.** *During operation the cable may be hidden in shrubs and can be accidentally cut by the blade.*

### Additional safety warnings

#### Battery safety



#### **DANGER! Fire risk!**

**The battery product to be charged must be placed on a non-flammable, heat resistant and non-conductive surface while charging.**

**Keep corrosive, flammable and easily combustible objects clear of the battery charger and the battery product.**

**Do not cover the battery charger and the battery product while charging.**

Disconnect the battery charger immediately in the event of smoke formation or fire.

Only use the original GARDENA Charger to charge the battery. The use of other battery chargers may damage the batteries irreparably and even cause a fire.

Do not charge any third-party batteries. There is a risk of fire and explosion!

If you notice fire: Extinguish the flames with oxygen reducing materials.



#### **DANGER! Risk of explosion!**

**Protect battery products from heat and fire. Do not leave on radiators or expose to strong sunshine for long periods.**

**Do not operate in explosive atmospheres, such as in the presence of flammable liquids, gases, or dust. Battery products may create sparks which could ignite the dust or fumes.**

Only charge and use the battery product in ambient temperatures of between 0 °C and 40 °C. Allow battery to cool down after long periods of use.

Check the charging cable regularly for signs of damage or ageing (brittleness). Only use it in perfect condition.

Do not stow or transport the battery product above 45 °C or in direct sunlight. Ideally, the battery product should be stored below 25 °C so that self-discharge is low.

Do not expose the battery product to rain or wet conditions. Water entering a battery product will increase the risk of electric shock.

If usage of the battery is not planned for a certain time (winter period) reload the battery to avoid a deep discharge.

Do not store the battery product in places where static electricity is present.

### Electrical safety



#### **DANGER! Cardiac arrest!**

**This product makes an electromagnetic field while it operates. This field may under some conditions interfere with active or passive medical implants. To decrease the risk of conditions that can possibly injure or kill, we recommend persons with medical implants to speak with their physician and the medical implant manufacturer before you operate the product.**

Thoroughly inspect the area where the product is to be used and remove all wires and other foreign objects.

Before using the product and after any impact, check for signs of wear or damage and repair as necessary.

If the product can no longer be switched off in the event of a defect, place the product on a solid surface and monitor it until the battery is empty. Send the defective product to our GARDENA Service Centre.

Never attempt to use an incomplete product or one with an unauthorised modification.

Stop the product if the product starts to vibrate abnormally. Check immediately. Excessive vibration can cause injury.  
Do not use the product nearby a water.  
Do not operate next to swimming pools or garden ponds.

#### Personal safety



#### DANGER! Risk of suffocation!

Small parts can be easily swallowed. There is also a risk that the poly-bag can suffocate toddlers. Keep toddlers away when you assemble the product.



#### DANGER! Risk of injury!

If the device switches off due to an empty battery (charging control lamp  flashes green), it may happen that the battery recovers after a certain time. The device is then ready for operation again.

Know how to stop the product quickly in an emergency.

Avoid contact to the oil of the blade in particular when you react allergic with it.

Only work in the daylight or when visibility is good.

Check your product before each use. Always visually inspect your Hedge Trimmer before each use. Check that the ventilation slots are not obstructed in any way.

Check the blade before usage.

Keep the blade well maintained.

If the product got hot while operation, let it cool down before storage.

Do not overload the product.

Warning! When wearing hearing protection, and due to the noise produced by the product, the operator may not notice persons approaching.

Always wear suitable clothing, protective gloves, and stout shoes.

Always ensure that you have a secure foothold whilst working.

Do not work on slippery underground.

## 2. OPERATION



#### DANGER! Risk of injury!

Cut injury when the product starts accidentally.

→ Wait for the blade to stop and slide the protective cover over the blade before you transport the product.

#### To charge the battery [Fig. O1]:







#### CAUTION!

Overvoltage damages the battery and the charging power supply.

→ Make sure that you use the correct mains voltage.



Before you use the battery the first time, the battery must be completely charged.

The lithium-ion battery can be charged in any state of charge and the charging process can be disconnected at any time without to damage the battery (no memory effect).

1. Connect the charging power supply  into a mains socket.  
*The power LED  illuminates red.*
2. Connect the battery charger cable  to the charging socket .

**When the charging control lamp  at the charging socket flashes green, the battery is being charged.**

**When the charging control lamp  at the charging socket illuminates green, the battery is completely charged** (Charging time, see 6. TECHNICAL DATA).

3. Examine the charge status regularly while you charge.
4. When the battery is completely charged, disconnect the battery charger cable  from the charging socket .
5. Disconnect the charging power supply  from the mains.

#### Work positions:

The hedge trimmer can be operated in 3 positions.

– Side trimming [Fig. O2]

– High trimming [Fig. O3]

– Low trimming [Fig. O4]

#### To start the hedge trimmer [Fig. O5]:









#### DANGER! Risk of injury!

Risk of injury if the product does not stop when you release the start levers.



→ Do not bypass the safety devices or switches. For example do not attach the start levers to the handle.

#### To start:

The product is provided with a two-handed safety device (2 start levers with starting lockout) to prevent the product from being turned on by accident.

1. Remove the protective cover from the blade.
  2. Hold the front handle  with one hand and push the front start lever .
  3. Hold the main handle  with the other hand, push the starting lockout  forward and pull the rear start lever .
- The hedge trimmer starts.*
4. Release the starting lockout  again.

#### To stop:

1. Release the two start levers /.
- The hedge trimmer stops.*
2. Wait for the blade to stop and slide the protective cover over the blade.

## 3. MAINTENANCE



#### DANGER! Risk of injury!

Cut injury when the product starts accidentally.

→ Wait for the blade to stop and slide the protective cover over the blade before you maintain the product.

#### To clean the Hedge Trimmer [Fig. M1]:



#### DANGER! Risk of injury!

Risk of injury and risk of damage to the product.

→ Do not clean the product with water or with a water jet (in particular high-pressure water jet).

→ Do not clean with chemicals including petrol or solvents. Some can destroy critical plastic parts.

#### The airflow slots must always be clean.

1. Clean the product with a damp cloth.
2. Clean the airflow slots  with a soft brush (do not use a screwdriver).
3. Spray the blade with the **GARDENA Cleaning Spray, Art. 2366**.  
*Avoid contact of the oil with the plastic parts.*

#### To clean the charging power supply:

Make sure that the contacts of the charging socket and the charging power supply always are clean and dry before you connect the charging power supply.

#### Do not use running water.

→ Clean the contacts and the plastic parts with a soft and dry cloth.

## 4. STORAGE

#### To put into storage:

The product must be stored away from children.

1. Charge the battery.
2. Clean the hedge trimmer and the charging power supply (see 3. MAINTENANCE).
3. Store the hedge trimmer and the charging power supply in a dry, enclosed and frost-free place.

#### Disposal:

(in accordance with RL2012/19/EC)

The product must not be disposed of to normal household waste. It must be disposed of in line with local environmental regulations.



The GARDENA battery contains lithium-ion cells that should not be disposed of with normal household waste at the end of its life.



#### IMPORTANT!

→ Dispose of the product through or via your municipal recycling collection centre.



## 5. TROUBLESHOOTING



**DANGER! Risk of injury!**

**Cut injury when the product starts accidentally.**

→ Wait for the blade to stop and slide the protective cover over the blade before you troubleshoot the product.

Problem	Possible Cause	Remedy
Hedge is not cleanly cut	Blade is blunt or damaged.	→ Let the blade be replaced by the GARDENA Service.
Hedge trimmer does not start. Charging control lamp  flashes green	Under voltage.	→ Charge the battery.
Hedge trimmer does not start. Charging control lamp  flashes red	Battery overload.	→ Release the start levers. Start again.
	Blade is blocked.	→ Remove the obstacle. Start again.
	Battery temperature is out of range.	→ Use the battery in surroundings where temperatures are between 0 °C and 40 °C.
Power LED  on the charging power supply does not illuminate	Charging power supply is not plugged in correctly.	→ Plug the charging power supply into a wall outlet.



**NOTE: For any other malfunctions please contact the GARDENA service department. Repairs must only be done by GARDENA service departments or specialist dealers approved by GARDENA.**

## 6. TECHNICAL DATA

Battery Hedge Trimmer	Unit	Value (Art. 9836)
Strokes	1/min	2400
Length of blade	cm	40
Tooth gap of blade	mm	16
Weight	kg	2.2
Sound pressure level $L_{pA}$ <sup>1)</sup> Uncertainty $k_{pA}$	dB(A)	75 3
Sound power level $L_{WA}$ <sup>2)</sup> : measured/guaranteed Uncertainty $k_{WA}$	dB(A)	93 / 94 0.6
Hand/arm vibration $a_{vhw}$ <sup>1)</sup> Uncertainty $k_a$	m/s <sup>2</sup>	< 2.5 1.5

Measuring process complying with: <sup>1)</sup> EN 60745-2-15 <sup>2)</sup> RL 2000/14/EC



**NOTE: The stated vibration emission value has been measured according to a standardized test procedure and can be used for comparison of one electric power tool with another. It can also be used for preliminary evaluation of exposure. The vibration emission value can vary during actual use of the electric power tool.**

Battery	Unit	Value
Battery voltage	V (DC)	14.4
Battery capacity	Ah	2.0
Battery charging time 80% / 100% (approx.)	min.	160 / 200

Charging Power Supply	Unit	Value (Art. 9836-20.610.00)
Mains voltage	V (AC)	100 – 240
Mains frequency	Hz	50 – 60
Rated Power	W	15
Output voltage	V (DC)	18.5
Max. output current	mA	600

## 7. ACCESSORIES

GARDENA Charging Power Supply	Charger to charge the internal batteries.	<b>Art. 9836-20.610.00</b>
GARDENA Cleaning Spray	Extends the life of the blade and the battery idling time.	<b>Art. 2366</b>

## 8. SERVICE/WARRANTY

### Service:

Please contact the address on the back page.

### Warranty:

In the event of a warranty claim, no charge is levied to you for the services provided.

GARDENA Manufacturing GmbH offers a two-year warranty (effective as of the date of purchase) for this product. This warranty includes all significant defects of the product that can be proved to be material or manufacturing faults. This warranty is fulfilled by supplying a fully functional replacement product or by repairing the faulty product sent to us free of charge; we reserve the right to choose between these options. This service is subject to the following provisions:

- The product was used for its intended purpose as per the recommendations in the operating instructions.
- Neither the purchaser nor a third party has attempted to repair the product.

This manufacturer's warranty does not affect warranty entitlements against the dealer/retailer.

If problems arise with this product, please contact our Service department or send the defective product along with a brief description of the fault to GARDENA Manufacturing GmbH, making sure to have sufficiently covered any shipping costs and to have followed the relevant postage and packaging guidelines. A warranty claim must be accompanied by a copy of the proof of purchase.

### Consumables:

The blade and excentric drive are consumables and are not included in the warranty.





**Deutschland / Germany**

GARDENA  
Manufacturing GmbH  
Central Service  
Hans-Lorenser-Straße 40  
D-89079 Ulm  
Produktfragen:  
(+49) 731 490-123  
Reparaturen:  
(+49) 731 490-290  
service@gardena.com

**Albania**

COBALT Sh.p.k.  
Rr. Siri Kodra  
1000 Tirana

**Argentina**

Husqvarna Argentina S.A.  
Av.del Libertador 5954 –  
Piso 11 – Torre B  
(C1428ARP) Buenos Aires  
Phone: (+54) 11 5194 5000  
info.gardena@  
ar.husqvarna.com

**Armenia**

Garden Land Ltd.  
61 Tigran Mets  
0005 Yerevan

**Australia**

Husqvarna Australia Pty. Ltd.  
Locked Bag 5  
Central Coast BC  
NSW 2252  
Phone: (+61) (0) 2 4352 7400  
customer.service@  
husqvarna.com.au

**Austria / Österreich**

Husqvarna Austria GmbH  
Industriezeile 36  
4010 Linz  
Tel.: (+43) 732 77 01 01-485  
service.gardena@  
husqvarnagroup.com

**Azerbaijan**

Firm Progress  
a. Aliyev Str. 26A  
1052 Baku

**Belgium**

Husqvarna België nv/sa  
Gardena Division  
Rue Egide Van Ophem 111  
1180 Uccle / Ukkel  
Tel.: (+32) 2 720 92 12  
info@gardena.be

**Bosnia / Herzegovina**

SILK TRADE d.o.o.  
Industrijska zona Bukva bb  
74260 Tešanj

**Brazil**

Husqvarna do Brasil Ltda  
Av. Francisco Matarazzo,  
1400 – 19º andar  
São Paulo – SP  
CNPJ: 05001-903  
Tel: 0800-112252  
marketing.br.husqvarna@  
husqvarna.com.br

**Bulgaria**

AGROLAND България АД  
бул. 8 Декември, №13  
Офис 5  
1700 Студентски град  
София  
Тел.: (+359) 24 66 69 10  
info@agroland.eu

**Canada / USA**

GARDENA Canada Ltd.  
100 Summerlea Road  
Brampton, Ontario L6T 4X3  
Phone: (+1) 905 792 93 30  
info@gardenacanada.com

**Chile**

Maquinarias Agroforestales  
Ltda. (Maga Ltda.)  
Santiago, Chile  
Avda. Chesterton  
# 8355 comuna Las Condes  
Phone: (+56) 2 202 4417  
Dalton@maga.cl  
Zipcode: 7560330

**China**

Husqvarna (Shanghai)  
Management Co., Ltd.  
富世华 (上海) 管理有限公司  
3F, Benq Square B,  
No207, Song Hong Rd.,  
Chang Ning District,  
Shanghai, PRC. 200335  
上海市长宁区淞虹路207号明  
基广场B座3楼, 邮编: 200335

**Colombia**

Husqvarna Colombia S.A.  
Calle 18 No. 68 D-31, zona  
Industrial de Montevideo  
Bogotá, Cundinamarca  
Tel. 571 2922700 ext. 105  
jairo.salazar@  
husqvarna.com.co

**Costa Rica**

Compania Exim  
Euroberoamericana S.A.  
Los Colegios, Moravia,  
200 metros al Sur del Colegio  
Saint Francis – San José  
Phone: (+506) 297 68 83  
exim\_euro@racsa.co.cr

**Croatia**

Husqvarna Austria GmbH  
Industriezeile 36  
4010 Linz  
Tel.: (+43) 732 77 01 01-485  
service.gardena@  
husqvarnagroup.com

**Cyprus**

Med Marketing  
17 Digeni Akrita Ave  
P.O. Box 27017  
1641 Nicosia

**Czech Republic**

Husqvarna Česko s.r.o.  
Türkova 2319/5b  
149 00 Praha 4 – Chodov  
Bezplatná infolinka:  
800 100 425  
servis@cz.husqvarna.com

**Denmark**

GARDENA DANMARK  
Lejrvej 19, st.  
3500 Værløse  
Tlf.: (+45) 70 26 47 70  
husqvarna@husqvarna.dk  
www.gardena.com/dk

**Dominican Republic**

BOSQUESA, S.R.L  
Carretera Santiago Licey  
Km. 5 ½  
Esquina Copal II.  
Santiago  
Dominican Republic  
Phone: (+809) 736-0333  
joserbosquesa@claro.net.do

**Ecuador**

Husqvarna Ecuador S.A.  
Arupos E1-181 y 10 de  
Agosto Quito, Pichincha  
Tel. (+593) 22800739  
francisco.jacome@  
husqvarna.com.ec

**Estonia**

Husqvarna Eesti OÜ  
Valdeku 132  
EE-11216 Tallinn  
info@gardena.ee

**Finland**

Oy Husqvarna Ab  
Gardena Division  
Lautatarhankatu 8 B/PL 3  
00581 HELSINKI  
www.gardena.fi

**France**

Husqvarna France  
9/11 Allée des pierres mayettes  
92635 Gennevilliers Cedex  
France  
http://www.gardena.com/fr  
N° AZUR: 0 810 00 78 23  
(Prix d'un appel local)

**Georgia**

Transporter LLC  
8/57 Beliashvili street  
0159 Tbilisi, Georgia  
Phone: (+995) 322 14 71 71

**Great Britain**

Husqvarna UK Ltd  
Preston Road  
Aycliffe Industrial Park  
Newton Aycliffe  
County Durham  
DL5 6UP  
info.gardena@  
husqvarna.co.uk

**Greece**

Π. ΠΑΠΑΔΟΠΟΥΛΟΣ ΑΕΒΕ  
Λεωφ. Αθηνών 92  
Αθήνα  
T.K.104 42  
Ελλάδα  
Τηλ. (+30) 210 51 93 100  
info@papadopoulos.com.gr

**Hungary**

Husqvarna Magyarország Kft.  
Ezred u. 1-3  
1044 Budapest  
Telefon: (+36) 1 251-4161  
vevoszolgalat.husqvarna@  
husqvarna.hu

**Iceland**

Ó. Johnson & Kaaber  
Tunguhalsi 1  
110 Reykjavik  
ooj@ojk.is

**Ireland**

Husqvarna UK Ltd  
Preston Road  
Aycliffe Industrial Park  
Newton Aycliffe  
County Durham  
DL5 6UP  
info.gardena@  
husqvarna.co.uk

**Italy**

Husqvarna Italia S.p.A.  
Via Santa Vecchia 15  
23868 VALMADRERA (LC)  
Phone: (+39) 0341.203.111  
assistenza.italia@  
it.husqvarna.com

**Japan**

KAKUICHI Co. Ltd.  
Sumitomo Realty &  
Development Kojimachi  
BLDG., 8F  
5-1 Nibannycyo  
Chiyoda-ku  
Tokyo 102-0084  
Phone: (+81) 33 264 4721  
m\_ishihara@kaku-ichi.co.jp

**Kazakhstan**

LAMED Ltd.  
155/1, Tazhibayevoi Str.  
050060 Almaty  
IP Schmidt  
Abayavenue 3B  
110 005 Kostanay

**Korea**

Kyung Jin Trading CO.,LTD.  
107-4, SunDuk Bld.,  
YangJae-dong,  
Seocho-gu,  
Seoul, (zipcode: 137-891)  
Phone: (+82) (0)2 574-6300

**Kyrgyzstan**

Alye Maki  
av. Moladaya Guardir J 3  
720014  
Bishkek

**Latvia**

Husqvarna Latvija SIA  
Ulbrokas 19A  
LV-1021 Rīga  
info@gardena.lv

**Lithuania**

UAB Husqvarna Lietuva  
Ateities pl. 77C  
LT-52104 Kaunas  
info@gardena.lt

**Luxembourg**

Magasins Jules Neuberger  
39, rue Jacques Stas  
Luxembourg-Gasperich 2549  
Case Postale No. 12  
Luxembourg 2010  
Phone: (+352) 40 14 01  
api@neuberger.lu

**Mexico**

AFOSA  
Av. Lopez Mateos Sur # 5019  
Col. La Calma 45070  
Zapopan, Jalisco  
Mexico  
Phone: (+52) 33 3818-3434  
icornejo@afosa.com.mx

**Moldova**

Convel S.R.L.  
290A Muncesti Str.  
2002 Chisinau

**Netherlands**

Husqvarna Nederland B.V.  
GARDENA Division  
Postbus 50131  
1305 AC ALMERE  
Phone: (+31) 36 521 00 10  
info@gardena.nl

**Neth. Antilles**

Jonka Enterprises N.V.  
Sta. Rosa Weg 196  
P.O. Box 8200  
Curaçao  
Phone: (+599) 9 767 66 55  
pgm@jonka.com

**New Zealand**

Husqvarna New Zealand Ltd.  
PO Box 76-437  
Manukau City 2241  
Phone: (+64) (0) 9 9202410  
support.nz@husqvarna.co.nz

**Norway**

Husqvarna Norge AS  
Gardena Division  
Trøskenveien 36  
1708 Sarpsborg  
info@gardena.no

**Peru**

Husqvarna Perú S.A.  
Jr. Ramón Cárcamo 710  
Lima 1  
Tel: (+51) 1 3320400 ext. 416  
juan.remuzgo@  
husqvarna.com

**Poland**

Husqvarna  
Poland Spółka z o.o.  
ul. Wysockiego 15 b  
03-371 Warszawa  
Phone: (+48) 22 330 96 00  
gardena@husqvarna.com.pl

**Portugal**

Husqvarna Portugal, SA  
Lagoa - Albarraque  
2635 - 595 Rio de Mouro  
Tel.: (+351) 21 922 85 30  
Fax : (+351) 21 922 85 36  
info@gardena.pt

**Romania**

Madex International Srl  
Soseaua Odaii 117-123,  
RO 013603 București, S1  
Phone: (+40) 21 352.76.03  
madex@ines.ro

**Russia / Россия**

ООО „Хускварна“  
141400, Московская обл.,  
г. Химки,  
улица Ленинградская,  
владение 39, стр.6  
Бизнес Центр  
„Химки Бизнес Парк“,  
помещение ОВ02\_04  
http://www.gardena.ru

**Serbia**

Domel d.o.o.  
Autoput za Novi Sad bb  
11273 Belgrade  
Phone: (+381) 1 18 48 88 12  
miroslav.jejina@domel.rs

**Singapore**

Hy-Ray PRIVATE LIMITED  
40 Jalan Pemimpin  
#02-08 Tat Ann Building  
Singapore 577185  
Phone: (+65) 6253 2277  
shiyiing@hyray.com.sg

**Slovak Republic**

Husqvarna Česko s.r.o.  
Türkova 2319/5b  
149 00 Praha 4 – Chodov  
Bezplatná infolinka:  
800 154 044  
servis@sk.husqvarna.com

**Slovenia**

Husqvarna Austria GmbH  
Industriezeile 36  
4010 Linz  
Tel.: (+43) 732 77 01 01-485  
service.gardena@  
husqvarnagroup.com

**South Africa**

Husqvarna  
South Africa (Pty) Ltd  
Postnet Suite 250  
Private Bag X6,  
Cascades, 3202  
South Africa  
Phone: (+27) 33 846 9700  
info@gardena.co.za

**Spain**

Husqvarna España S.A.  
Calle de Rivas nº 10  
28052 Madrid  
Phone: (+34) 91 708 05 00  
atencioncliente@gardena.es

**Suriname**

Agrofix n.v.  
Verlengde Hogestraat #22  
Phone: (+597) 472426  
agrofix@sr.net  
Pobox : 2006  
Paramaribo  
Suriname – South America

**Sweden**

Husqvarna AB  
Gardena Division  
S-561 82 Husqvarna  
Gardenaorder@husqvarna.se

**Switzerland / Schweiz**

Husqvarna Schweiz AG  
Consumer Products  
Industriestrasse 10  
5506 Mägenwil  
Phone: (+41) (0) 62 887 37 90  
info@gardena.ch

**Turkey**

Dost Bahçe Diş Ticaret  
Müessesilik A.Ş  
Yunus Mah. Adil Sok. No:3  
Ic Kapi No: 1 Kartal  
34873 Istanbul  
Phone: (+90) 216 38 93 939  
info@dostbahce.com.tr

**Ukraine / Україна**

ТОВ «Хускварна Україна»  
вул. Васильківська, 34,  
офіс 204-г  
03022, м. Київ  
Тел. (+38) 044 498 39 02  
info@gardena.ua

**Uruguay**

FELI SA  
Entre Rios 1083 CP 11800  
Montevideo – Uruguay  
Tel: (+598) 22 03 18 44  
info@felisa.com.uy

**Venezuela**

Corporación Casa y Jardín C.A.  
Av. Caroní, Edif. Trezmen, PB.  
Colinas de Bello Monte.  
1050 Caracas.  
Tlf: (+58) 212 992 33 22  
info@casayjardin.net.ve

9836-20.960.01/0618  
© GARDENA  
Manufacturing GmbH  
D-89070 Ulm  
http://www.gardena.com