



Husqvarna®



Operator's manual

DXR140

Please read the operator's manual carefully and make sure you understand the instructions before using the machine.



English

KEY TO SYMBOLS

Symbols on the machine

WARNING! The machine can be a dangerous tool if used incorrectly or carelessly, which can cause serious or fatal injury to the operator or others.

Please read the operator's manual carefully and make sure you understand the instructions before using the machine.

Noise emission to the environment according to the European Community's Directive. The machine's emission is specified in the Technical data chapter and on the label.

Always wear:

- Tight-fitting, heavy-duty and comfortable clothing that permits full freedom of movement.
- Sturdy, non-slip boots or shoes.
- Protective gloves.
- Protective helmet.
- Hearing protection.
- Protective goggles or a visor.
- A breathing mask, gas mask or fresh air helmet must be used when working in environments where the air can be harmful to health.

WARNING! Live parts.

WARNING! Ensure that no material can fall down and cause damage when you are using the machine.

WARNING! Watch out for demolition material becoming loose when working. Use personal safety equipment and keep your distance.

WARNING! Always position yourself above the machine when driving on a slope. There is a risk of the machine tipping.

WARNING! Exercise particular caution when working close to edges. Ensure that the machine is stable and does not move closer to the edge while the work is in progress. Ensure that the underlying surface has satisfactory bearing capacity.

Inspections and/or maintenance must be carried out with the motor switched off and the power cord disconnected.

Always connect the machine through a ground fault circuit interrupter with personal

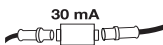
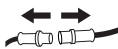

protection, i.e. a ground fault circuit interrupter that trips at a ground fault of 30 mA.

Ensure that the power cable cannot be run over. Take particular care when moving or when the outriggers are being retracted or extended. Risk of electric shock.

The lifting equipment must be attached at all the machine's lifting points.



Keep your distance! Nobody is permitted to be within the machine's risk area when work is underway. The machine's risk area can vary during the course of the work. See chapter Safety instructions.

The machine can overturn during work. During operation the machine must be positioned as level as possible and the outriggers must be fully extended.

Pressurized hydraulic accumulator. No service operations may be performed on the hydraulic system until the pressure has been manually discharged. See chapter Maintenance and service.

Gearbox oil



Drain



Hydraulic oil



Environmental marking. Symbols on the product or its packaging indicate that this product cannot be handled as domestic waste.

By ensuring that this product is taken care of correctly, you can help to counteract the potential negative impact on the environment and people that can otherwise result through the incorrect waste management of this product.

For more detailed information about recycling this product, contact your municipality, your domestic waste service or the shop from where you purchased the product.



KEY TO SYMBOLS

Explanation of warning levels

The warnings are graded in three levels.

WARNING!



WARNING! Used if there is a risk of serious injury or death for the operator or damage to the surroundings if the instructions in the manual are not followed.

IMPORTANT!



IMPORTANT! Used if there is a risk of injury to the operator or damage to the surroundings if the instructions in the manual are not followed.

CAUTION!

CAUTION! Used if there is a risk of damage to materials or the machine if the instructions in the manual are not followed.

Note the following before starting:



WARNING! Cutting, especially when **DRY** cutting, generates dust that comes from the material being cut, which frequently contains silica. Silica is a basic component of sand, quartz, brick clay, granite and numerous other minerals and rocks. Exposure to excessive amount of such dust can cause:

Respiratory disease (affecting your ability to breath), including chronic bronchitis, silicosis and pulmonary fibrosis from exposure to silica. These diseases may be fatal;

Skin irritation and rash.

Cancer according to NTP* and IARC* */ National Toxicology Program, International Agency for Research on Cancer

Take precautionary steps:

Avoid inhalation of and skin contact with dust, mist and fumes.

Wear and ensure that all bystanders wear appropriate respiratory protection such as dust masks designed to filter out microscopic particles. (See OSHA 29 CFR Part 1910.1200)

Wet cut when feasible, to minimize dust.

CONTENTS

Contents

KEY TO SYMBOLS

Symbols on the machine	2
Explanation of warning levels	3
Note the following before starting:	3

CONTENTS

Contents	4
----------------	---

INTRODUCTION

Dear customer!	5
Good service	5
Serial Number	5
Applications	5
User responsibility	5
The manufacturer's reservation	5

PRESENTATION

What is what on the machine?	6
The machine's functions	7

HYDRAULIC SYSTEM

The machine's hydraulic system	8
General	9
Main pressure	9
Cooler	9

ELECTRICAL SYSTEM

The machine's electric system	10
General	11
High-voltage circuit	11
Low-voltage circuit	11

CONTROL SYSTEM

What is what on the remote control?	12
General	13
Remote control	13
Signal transmission	13
Battery	13
The machine's software	13

MACHINE'S SAFETY EQUIPMENT

General	14
---------------	----

SAFETY INSTRUCTIONS

Protective equipment	16
General safety warnings	16
General working instructions	17
External environmental factors	22

STARTING AND STOPPING

Before starting	23
Starting	23
Stopping	23
Inspection after work	23

OPERATION

Operating modes	24
Pattern description	25

TOOLS

General	28
Work mode	29
Changing tools	29
Storage	30

ACCESSORIES

Accessory kits	31
Service check	33
What is what on the control unit?	33
Connect the service check	34

SETTINGS

Menu overview	35
Operational settings	35
Work	35
Transport	36
Service	37

MAINTENANCE AND SERVICE

General	47
Measures to take in advance of maintenance, service and trouble shooting	47
After Maintenance and Service	47
Cleaning	48
Service schedule	49
Service review	51

TROUBLESHOOTING

Error messages	57
Troubleshooting schedule	62

TECHNICAL DATA

Guide values for mains connection	64
The hydraulic system pressure	64
Hydraulic fluid and lubricant	64
Preset limit values	65
Technical data	65
Reach and transport diagram	67

US WARRANTY STATEMENT

WARRANTY POLICY	69
EQUIPMENT	69

INTRODUCTION

Dear customer!

Thank you for choosing a Husqvarna DXR 140!

This operator's manual is a valuable document. Make sure it is always at hand at the work place. By following its instructions (on operation, service, maintenance, etc.) you will significantly extend the life of the machine and even its second-hand value.

Good service

Husqvarna products are sold all over the world and ensures that you, the customer, get the best support and service. When you need spare parts or advice on service or warranty issues, go to www.husqvarnacp.com and find your local service agent.

Serial Number

The machine's serial number is indicated on the arm by the mounting against the tower. Stated on the plate are:

- The machine's type designation
- Weight
- The manufacturer's type number
- The machine's serial number
- Manufacturer

The hydraulic pump and hydraulic motors are fitted with rating plates that indicate article number and the machine manufacturer's manufacture number.

Please state the type designation and serial number when ordering spare parts and for service matters.

Applications

The machine is intended for:

- Demolishing, fragmenting, cutting, detaching, separating, picking up and distributing parts of buildings and constructions.
- Use in risky environments where the operator can control the machine without being present within the risk area.
- Use both indoors and outdoors.
- Use in dangerous environments where the machine is exposed to risk of collapse, hazardous substances, great heat, etc.

The machine is NOT intended for:

- Use in areas classified as 'explosive'.
- Use in water where the level risks damaging the machine's equipment.
- Operation on a public highway.
- Use as a towing vehicle, means of transport or lifting device.
- Use in environments where there is danger for the operator or the life and health of people in the vicinity.

- Use in applications or environments that are not compatible with the recommendations in this Operator's Manual.

User responsibility

It is the owner's/employer's responsibility that the operator has sufficient knowledge about how to use the machine safely. Supervisors and operators must have read and understood the Operator's Manual. They must be aware of:

- The machine's safety instructions.
- The machine's range of applications and limitations.
- How the machine is to be used and maintained.

National legislation could regulate the use of this machine. Find out what legislation is applicable in the place where you work before you start using the machine.

The manufacturer's reservation

Husqvarna Construction Products reserves the right to alter specifications and instructions for the machine without prior notification. The machine may not be modified without the manufacturer's written permission. If the machine is modified after delivery from Husqvarna Construction Products and without the manufacturer's written permission, it is the owner's responsibility.

Modification can entail new risks for operators, the machine and the surroundings. These can include impaired strength or inadequate protection. It is the responsibility of the owner to specify which alterations are going to be made and to contact the supplier of the machine for approval before commencing the modifications.

All information and all data in the Operator's Manual were applicable at the time the Operator's Manual was sent to print.

Contact

Husqvarna Construction Products, Jons väg 19, SE-433 81 Göteborg, Sweden.

PRESENTATION

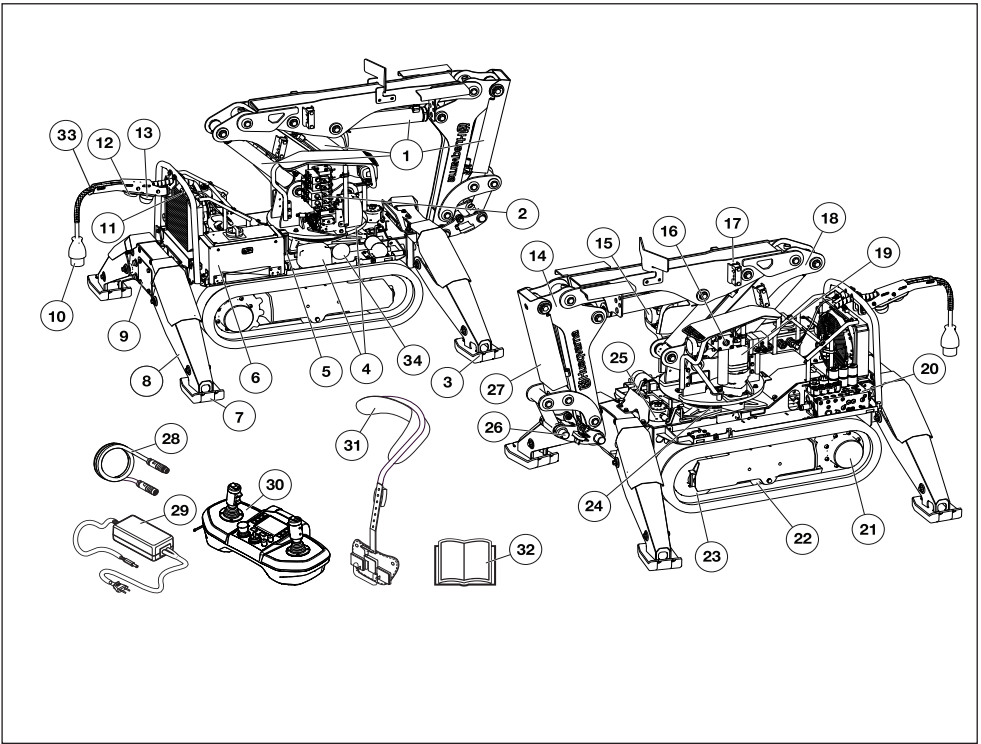

What is what on the machine?

- | | |
|---|-------------------------------|
| 1 Cylinders | 17 Arm 2 |
| 2 Valve block, arm system | 18 Arm 1 |
| 3 Lifting eye | 19 Slew motor |
| 4 Control module | 20 Valve block, chassis |
| 5 Radio module | 21 Drive motor |
| 6 Electrical cabinet | 22 Support wheel |
| 7 Outrigger foot | 23 Tensioning wheel |
| 8 Outriggers | 24 Gear ring |
| 9 Inspection hatch | 25 Hydraulic tank |
| 10 Power cable | 26 Tool attachment |
| 11 Emergency stop | 27 Cylinder guard |
| 12 Antenna | 28 Communication cable |
| 13 Warning light | 29 Battery charger |
| 14 Arm 3 | 30 Remote control |
| 15 Working lights | 31 Harness |
| 16 Lubrication pump for lubricating the breaker | 32 Operator's manual |
| | 33 Communication cable socket |
| | 34 Horn |

PRESENTATION

The machine's functions

The machine's functions are operated by means of interaction between the hydraulic system, the electric system and the control system.

A brief description of the machine's functions follows below.

Arm system

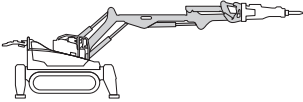

The arm system is divided into three parts in order to provide extensive movement, a long reach and compactness. Expanding shafts minimize the risk of play in the joints.

Work as close to the work object as possible as this makes optimum use of the power to the arm system and cylinders.

By running cylinder 1 and cylinder 2 in parallel, the machine's reach can be modified without moving the machine.

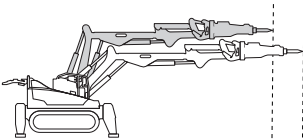

Tower

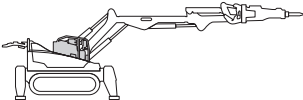

The tower can be turned indefinitely which makes it possible to work in several directions without having to move the machine.

The machine is equipped with a slew brake. When the rotating function is not activated, the function is braked by means of passive brakes.

NOTICE! The machine's rotating function must not be subject to overload, e.g. caused by tools that exceed the weight limit.

Caterpillar tracks

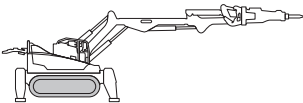

The caterpillar tracks are driven individually by hydraulic motors. The machine can be turned by operating the caterpillar tracks at different speeds. Operating the tracks in different directions enables the machine to make tight

maneuvers. When the drive function is not activated the passive brakes lock the drive motors.

In the transport mode you can control the caterpillar tracks and the tower at the same time. This function is useful when the machine is used in for example narrow spaces.

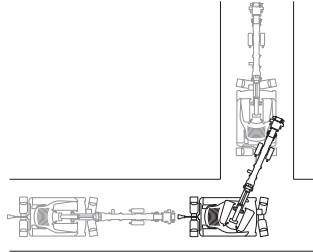

Outriggers

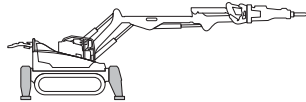

The main function of the outriggers is to give the machine stability. They must always be used when working with the machine.

Tools

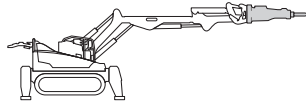

The machine should be fitted with tools that are appropriate for the tasks that are to be carried out. The weight and performance requirement of the tool is decisive in ascertaining whether it is suitable for use with the machine. Further information is available in the "Tools" and "Technical data" chapters and the tool supplier's instructions.

External tool (optional)

The machine has been prepared with connections for external hand tools for the machine's hydraulic system.

HYDRAULIC SYSTEM

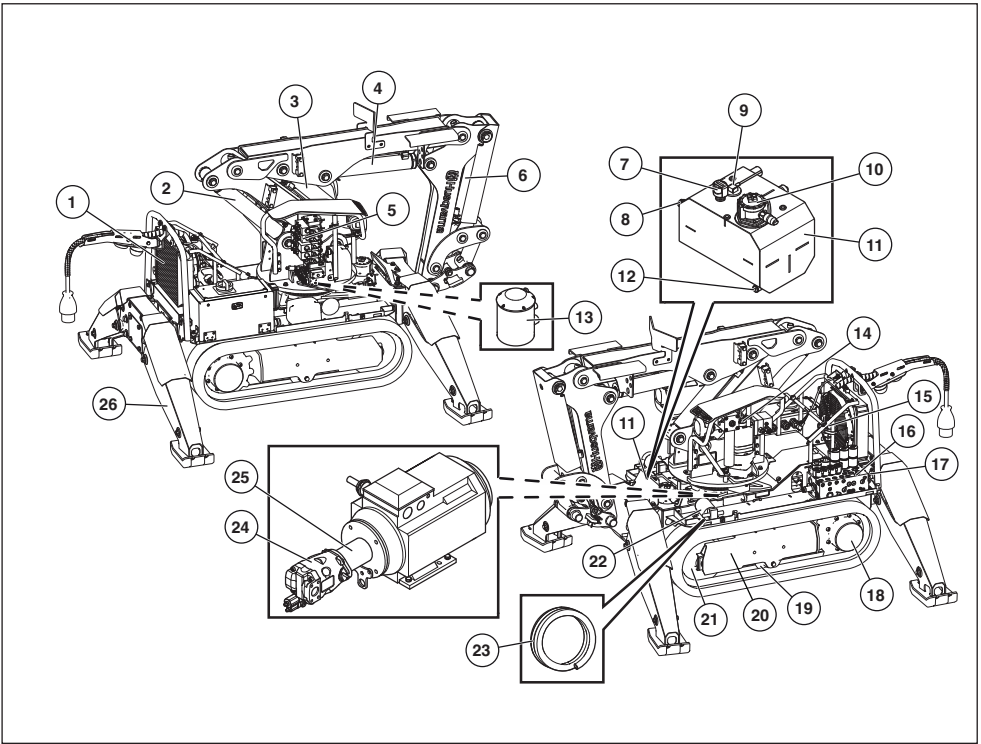

The machine's hydraulic system

- | | | | |
|----|-------------------------|----|-----------------------------|
| 1 | Cooler | 13 | Swivel |
| 2 | Cylinder 1 | 14 | Slew motor |
| 3 | Cylinder 2 | 15 | Accumulator - track tension |
| 4 | Cylinder 3 | 16 | Valve block, chassis |
| 5 | Valve block, arm system | 17 | Valve for track tension |
| 6 | Cylinder 4 | 18 | Drive motor |
| 7 | Air filter | 19 | Support wheel |
| 8 | Sight gauge | 20 | Cylinder for track tension |
| 9 | Level indicator | 21 | Tensioning wheel |
| 10 | Oil filter | 22 | Filling pump |
| 11 | Hydraulic tank | 23 | Hose for oil filling |
| 12 | Drain plug | 24 | Hydraulic pump |
| | | 25 | Intermediate piece |
| | | 26 | Cylinders for outriggers |

HYDRAULIC SYSTEM

General

The task of the hydraulic system is to operate the machine's functions by means of hydraulic pressure and flow. The system consists of hydraulic pump, tank, cooler, hydraulic motor, hydraulic cylinders, filters and valves of various kinds. Hoses or pipes connect the components with each other.

Valves are used to control the hydraulic system's pressure, volume rate of flow and direction. Pressure control valves limit or reduce the pressure to the value required. Volume control valves affect the hydraulic oil's flow and thereby the speed of the functions. Direction control valves direct the hydraulic oil to the machine's different functions.

The hydraulic pump is of the variable displacement type and delivers a flow of 0-52 l/min (0-14 gal/min).

Main pressure

The hydraulic system has different pressure levels.

- Hydraulic breaker 160 Bar (15 kW)
- Standard pressure is 200 Bar
- Increased main pressure is 250 Bar

Increased main pressure is used when the outriggers are extended and when running arm system inward in parallel motion.

the oil temperature raises above 80 °C (176 °F) the breaker pressure will automatically be decreased to make the machine able to run longer before it is overheated.

Cooler

The cooler has an integrated bypass valve that protects against overpressure in conjunction with, for example, cold start.

ELECTRICAL SYSTEM

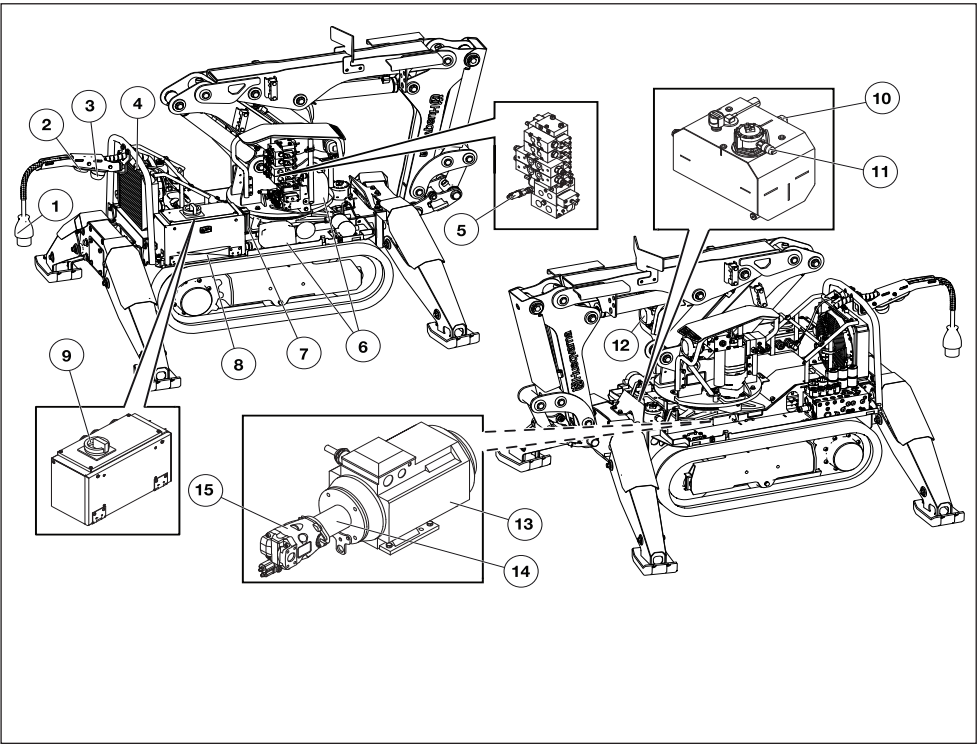

The machine's electric system

- 1 Power cable
- 2 Antenna
- 3 Warning light
- 4 Emergency stop
- 5 Pressure sensor
- 6 Control module
- 7 Radio module
- 8 Electrical cabinet
- 9 Main switch
- 10 Temperature sensor
- 11 Pressure switch
- 12 Working lights
- 13 Electric motor

General

The electric system consists of a high-voltage circuit and a low-voltage circuit.

High-voltage circuit

High-voltage is used as a power source for both the electric motor and the low-voltage circuit. An automatic phase rotation change-over switch ensures that the electric motor has the correct rotation direction.

Power supply

The power supply from the grid or generator must be sufficiently powerful and constant to ensure that the electric motor runs without problems.

Too high or too low voltage causes the electric motor's power consumption, and consequently also its temperature, to increase until the motor's safety circuit trips.

Fuses

The fuses in the distribution box protect the electrical system in conjunction with overloading or breakdown. The power outlet must be correctly fused with respect to the electric motor, the length of the power cable and the area of the power cable's conductor. The table 'Guide values for mains connection' in the 'Technical data' section shows which fuse is required for the electric motor.

The machine is equipped with Softstart and can be started with most types of fuses.

If a fuse keeps blowing, there is a fault in the electrical system or in the machine that is connected to it. Before restarting the machine the source of the fault must be removed.

Power cable

The machine is connected to the power supply with a 3 phase power cable. It is very important that the cable that is used is correctly dimensioned, i.e. that it has the correct cross-sectional area in relation to the length of the conductor in order to counteract drops in voltage. The guide values for the cable's size are set out in the table 'Guide values for mains connection' in the 'Technical data' section.

Low-voltage circuit

The high-voltage power is converted to low-voltage in an AC/DC module. It is used to supply power to the control system and functions such as work lighting and refilling pump.

CONTROL SYSTEM

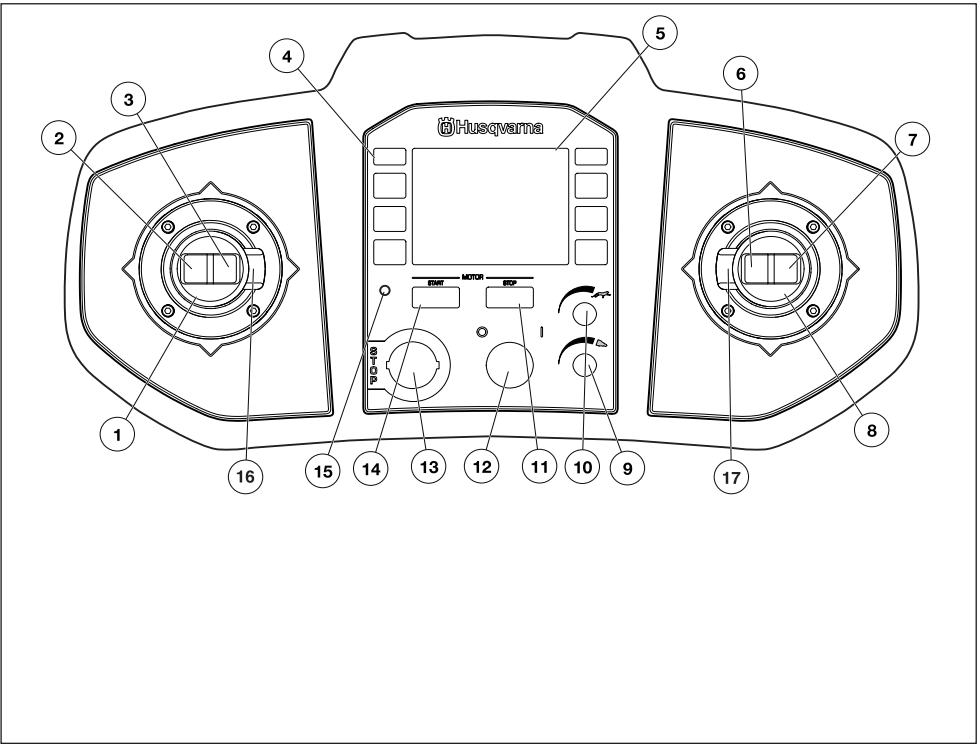

What is what on the remote control?

- 1 Left joystick
- 2 Left joystick - left button
- 3 Left joystick - right button
- 4 Menu buttons
- 5 Display
- 6 Right joystick - left button
- 7 Right joystick - right button
- 8 Right joystick
- 9 Pressure/flow to hydraulic tool (breaker/cutter)
- 10 Flow to machine movement/speed
- 11 Stop button motor
- 12 Main switch
- 13 Machine stop
- 14 Start button motor
- 15 Light emitting diode, joysticks active
- 16 Left joystick - left thumb switch
- 17 Right joystick - right thumb switch

CONTROL SYSTEM

General

The remote control, the electronics unit and the pilot control valves are the main components in the control system. The signals from the remote control are transmitted to the machine via bluetooth or via a cable. The electronic unit in the machine transmits the signals via the pilot control valves to the hydraulic system by converting electric power into hydraulic pressure.

Remote control

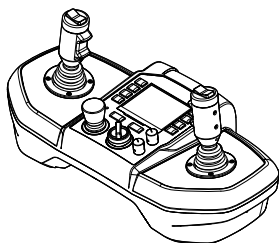

The machine is controlled from the remote control. Transmission of signals is either wireless, using bluetooth, or via a cable.

The movement of the joysticks is proportional. A small movement means that the function moves slowly, a larger movement increases the function's speed proportionally.

Signal transmission

Identity code

Each machine has its own unique ID code. Upon delivery the remote control is pre-programmed with the machine's unique ID code. The remote control can be reprogrammed, remated, so that it can be used together with another machine. This can be useful if a remote control should stop working. See instructions in the section "Settings" under "Tuning" and "Mating Bluetooth® radio modules" for information on how to adjust the setting.

Wireless signal transmission

Wireless transmission of signals uses bluetooth technology.

Automatic frequency hopping

In the event of interference in the communication, the frequency changes automatically to guarantee interference-free transmission.

Signal transmission using cables

Connecting a cable shuts off the wireless communication.

When the machine is controlled by means of cables, the ID code is suppressed and the same remote control can be used for different machines if these have the same control system version.

Battery

The battery is a Li-ion type. Operating time is about 8-10 hours per charge. Extreme cold impairs the battery's capacity and operating time. Operating time is also affected by the extent to which the display has been active.

To save the battery, the display goes into energy save mode after 30 seconds. After 10 minutes of inactivity, the radio communication is disconnected, and the remote control goes into standby mode. Turn on the display by pressing any of the function buttons.

A message appears on the display approx. 30 minutes before the battery is completely flat. It is not possible to activate the remote control if the battery capacity is too low.

Charging the battery

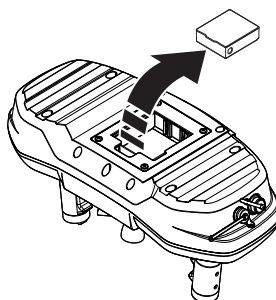

Before using the remote control for the first time the battery has to be charged.

Charging time for a flat battery is approx. 2-3 hours. The diode is red when charging starts and becomes green when the battery is fully charged. When the battery is fully charged the charger supplies the battery with maintenance power until the battery is removed from the charger.

Keep the battery charger dry and protected against temperature fluctuations.

The battery is charged also when the communication cable is connected between the terminal and the machine. The battery symbol on the terminal display shows the charging status.

The machine's software

Contact your service workshop regarding problems with the machine's software or for any updates that might be needed.

MACHINE'S SAFETY EQUIPMENT

General

In this section the machine's safety features and their function are explained. Concerning inspection and maintenance, see the instructions under Maintenance and service.

The machine's safety features can be divided into safety features for personal protection and those for mechanical protection. Some of the safety features provide both mechanical and personal protection.



WARNING! Do not modify the machine's safety devices and check regularly that they are working properly. The machine must not be driven if protective plates, protective covers, safety switches or other protective devices are not fitted or are defective.

Personal protection

Indication of zero position

If either of the joysticks is in an operative position when the remote control is started, the function will be blocked. The operator is informed of this by means of an error message appearing on the screen. To reset the function, the remote control must be turned off and on again.

The function also protects against faults in the potentiometer or cable breaks.

Signal voltage limitation

Signal voltage limitation prevents the machine executing unexpected movements in the event of a cable breaking or a short-circuit.

The voltage level of the control signals is limited to within a maximum and minimum value. If the voltage level falls outside the permitted interval, the machine stops.

Joystick guard

The safety feature reduces the risk of unintentionally moving the machine by locking the control circuit if the joysticks have been in neutral for three seconds.

The control circuit is activated by means of the left button or thumb switch in down direction on the right joystick. It is activated when the button is released. This guards against fixing the button in an active position.

Radio block

If the remote control has lost connection for two minutes the electronic unit in the machine is blocked to radio signals. A message appears on the display. Confirm the message to return to normal operation.

The safety feature ensures that the operator knows which machine will start and that the correct remote control is being used for the machine. This is particularly important when there are several machines at the same workplace.

Identity code

The remote control and the machine are connected by means of a pre-programmed ID code. The ID code ensures that the right remote control is used for the right machine.

If several machines are used at the same workplace there is a risk of mixing up the remote controls.

Switch on the power to the remote control and the machine. Press the horn to see which machine is connected to the remote control. The machine will beep and flash three times. Do not activate the remote control before you have ensured that the correct machine is being operated.

When steering the machine using cables, the ID code is suppressed and the same remote control can be used for different machines if these have the same control system version.

Automatic frequency hopping

In the event of interference in the communication, the frequency changes automatically to guarantee interference-free transmission.

Emergency stop/machine stop

The machine stop on the remote control and the emergency stop on the machine break the power to the electric motor.

Protective earth

The machine and its components are connected to grounding conductors in the power cable. The machine must be connected to a power point with a protective earth and if there is a fault, a fuse is tripped after the power is disconnected.

If there are no grounding conductors, or if they are connected incorrectly, the power will remain connected and touching the machine can be highly dangerous.

If there is reason to believe that the protective earth has been damaged, the machine must be turned off and the power cable removed until such time as the protective earth has been restored.

Always connect the machine through a ground fault circuit interrupter with personal protection, i.e. a ground fault circuit interrupter that trips at a ground fault of 30 mA.

Hydraulic brake

Hydraulic motors are used when moving the machine. All hydraulic motors are fitted with brakes. These hydraulic motors contain counter balance valves that prevent uncontrolled flow through the motor, e.g. when manoeuvring down a slope or when the machine is parked. The counter balance valve closes the tank opening when the drive motors are not being operated.

Mechanical brake

The machine's drive motors are equipped with a mechanical parking brake. The machine is braked until its drive function is activated.

MACHINE'S SAFETY EQUIPMENT

Locking of the main switch

The main switch on the machine can be locked with a padlock to prevent unauthorized persons from starting the machine.

Mechanical protection

Automatic phase rotation relay

The automatic phase rotation relay prevents the electric motor starting with the wrong rotation direction thus causing mechanical damage.

Motor protection

To prevent overloading, the motor is equipped with bimetallic relays in the motor linings that disconnect the power to the motor if it gets too hot.

If the motor is too hot it is not possible to operate the tools. The rest of the machine's functions can be run at half speed in order to facilitate evacuation of the machine from risky environments.

Once the motor's temperature has fallen to a normal working temperature all functions can be used again.

The machine's softstarter is fitted with a motor cut-out that trips if the power is too high for too long. The machine's functions return to normal position after approximately three minutes.

Fuses

Fuses are used to protect the electric components as well as to prevent fire in conjunction with faults or if electrical components are overloaded.

Pressure relief valves

The machine's hydraulic system is equipped with pressure relief valves. They protect the hydraulic system against too high pressure and the mechanical components against overloading.

Circulation valve

The circulation valve drains the hydraulic flow into a tank and relieves the pressure on the hydraulic system. No pressure enters the cylinders and it prevents the risk of unforeseen movements. This happens, for example, after three seconds of inactivity.

SAFETY INSTRUCTIONS

Protective equipment

Personal protective equipment



WARNING! You must use approved personal protective equipment whenever you use the machine. Personal protective equipment cannot eliminate the risk of injury but it will reduce the degree of injury if an accident does happen. Ask your dealer for help in choosing the right equipment.

Always wear:

- Protective helmet.
- Hearing protection.
- Protective goggles or a visor.
- Tight-fitting, heavy-duty and comfortable clothing that permits full freedom of movement.
- Protective gloves.
- Sturdy, non-slip boots or shoes.
- A breathing mask, gas mask or fresh air helmet must be used when working in environments where the air can be harmful to health.
- Always have a first aid kit nearby.

Other protective equipment

- Fall protection must be used when working at height or if there is a risk of collapse. The operator and the machine must be safeguarded with separate fall protection.
- Screening equipment and modified protective clothing must be used when working in hot environments.
- Barriers must be used to inform people in the vicinity of the machine's risk area.
- Equipment must be used to secure machine parts during maintenance and service.

General safety warnings



WARNING! Please read the operator's manual carefully and make sure you understand the instructions before using the machine.

The machine is used in a large range of environments and for different types of work, making it impossible to warn users of all risks. Always exercise care and use your common sense. Avoid all situations which you consider to be beyond your capability. If you still feel uncertain about operating procedures after reading these instructions, you should consult an expert before continuing.

Do not hesitate to contact your dealer if you have any more questions about the use of the machine. We will willingly be of service and provide you with advice as well

as help you to use your machine both efficiently and safely.

Use the safety instructions as guidelines and support so that you can detect possible risks yourself and take measures to prevent them.

Let your Husqvarna dealer regularly check the machine and make essential adjustments and repairs.

Management and operator

Management and the operator are responsible for identifying and preventing risks to ensure staff and equipment are not exposed to danger.

Responsibility

It is the responsibility of management and the operator to confirm:

- National and local laws, regulations and other directions are followed. This might concern protective equipment, limit levels for noise, barriers, etc.
- The operator has the relevant training and experience to be able to perform the work safely.
- Unauthorized persons are not permitted to enter areas where there is a risk of accidents.
- Nobody is permitted to be within the machine's risk area when work is underway.
- Persons who are admitted to the work area are trained in and have access to protective equipment.
- The machine is used solely for the functions for which it is intended.
- The machine is used safely.
- The machine is correctly connected to a suitable power supply and correctly fused.
- The operator is informed of the work area surroundings, e.g. strength in the floor structure, positioning of load-bearing walls, cables and pipes.

Requirements of the operator:

- The operator must be given sufficient information and training to have satisfactory knowledge of the machine's functions, properties and limitations.
- The operator must try to foresee risky elements of the job and assess the machine's risk area. Always exercise caution and use common sense!
- It is the responsibility of the operator to suspend work with the machine if a safety risk arises and ensure that the machine is not used by mistake. The machine must not be put into operation before the safety risk has been eliminated.
- The operator must not be under the influence of drugs or anything else that can affect his/her reactions or judgement.
- The operator must use protective equipment suited for the particular work situation.
- The operator must ensure that the machine cannot be used by unauthorized persons, e.g. do not leave the remote control unattended.

SAFETY INSTRUCTIONS

If there is an accident

It is the responsibility of the employer to produce an action plan and train operators how to deal with incidents. First take action to save human life and second to avoid material damage. Learn how to administer first aid!

Measures to take in the event of an accident:

- Get an overview. Is anyone injured? Is anyone still in the area where the accident took place?
- Alert emergency services and be prepared to provide information.
- Administer first aid and prepare a route for the emergency personnel.
- Ensure that someone accompanies the injured to the hospital.
- Secure the scene of the accident.
- Contact management.
- Contact relatives.
- Investigate the cause of the accident.
- Put measures in place to prevent future accidents.
- Always notify Husqvarna Construction Products in the event of near-accidents or accidents regardless of whether the machine was directly or indirectly involved in the incident.

General working instructions



WARNING! Read all safety warnings and all instructions. Neglecting to follow the warnings and instructions can lead to serious injury or death for the operator or others.

This section describes basic safety directions for using the machine. This information is never a substitute for professional skills and experience. If you get into a situation where you feel unsafe, stop and seek expert advice. Contact your dealer, service agent or an experienced user. Do not attempt any task that you feel unsure of!

Work area safety

The machine's risk area

Nobody is permitted to be within the machine's risk area when work is underway. This also applies for the operator.

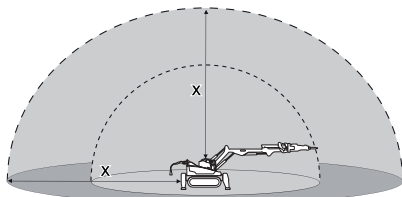

The working area is limited by the machine's reach, however, the risk area varies depending on working method, work object, surface etc. Study possible risks

before starting work. If conditions change during the course of the work, the risk area must be redefined.

Workplace

- Define and cordon off the risk area. Nobody is permitted to be within the machine's risk area when work is underway.
- Ensure that the working area is sufficiently illuminated to create a safe working environment.
- The machine can be remote controlled over long distances. Do not operate the machine unless you have clear supervision of the machine and its risk area. If the view of the machine and its risk area is not good enough a camera system should be used.
- Never start working with the machine until the working area has been cleared of obstacles.
- Be on the alert when working in environments where there is a substantial risk of slipping due to unevenness, loose material, oil, ice or suchlike.
- Inspect ground conditions, load-bearing structures etc. to prevent materials, machines and staff falling and deal with any risks there might be before starting work.
- When working at a height, for instance on roofs, platforms, etc., increase the size of the risk area. Define and cordon off the risk area at ground level and ensure that no material can fall down and cause injury.
- Do not use the machine in environments where there is a risk of explosion. Take the risk of spark formation into account when working in flammable environments.
- Always check and mark where electricity cables and pipelines are routed.
- The air in confined spaces can rapidly become harmful to health due to, for example, dust and gases. Use protective equipment and ensure that there is satisfactory ventilation.

Electrical safety

- Check that the main voltage corresponds with the machine's rating plate.
- The machine must be connected to a functioning protective earth.
- Check all cables and connections. Damaged electric cables can impede the machine's function and lead to personal injuries. Do not use damaged connectors or cables.
- The electric cabinet must not be opened when the machine is connected to power. Some components in the electric cabinet are permanently live, even if the machine is turned off.
- Always connect the machine through a ground fault circuit interrupter with personal protection, i.e. a ground fault circuit interrupter that trips at a ground fault of 30 mA.
- The machine must never be driven to such a depth in water that it reaches up to the machine's equipment.

SAFETY INSTRUCTIONS

The equipment can be damaged and the machine can be live, resulting in personal injuries.

- Ensure that the power cable cannot be run over. Take particular care when moving or when the outriggers are being retracted or extended. Risk of electric shock.
- To avoid overheating do not use an electric cable while it is coiled.
- Always de-energize the machine when carrying out maintenance work and when it is not in use. Disconnect the power cable and place it so that it cannot be connected by mistake.

Personal safety



WARNING! This machine produces an electromagnetic field during operation. This field may under some circumstances interfere with active or passive medical implants. To reduce the risk of serious or fatal injury, we recommend persons with medical implants consult their physician and the medical implant manufacturer before operating this machine.

- Never use the machine if you are tired, if you have consumed alcohol, if you are taking other drugs or medication that can affect your vision, judgement or coordination.
- Wear personal protective equipment. See instructions under the heading "Personal protective equipment".
- Chemicals such as degreasing agent, grease and hydraulic fluid can give rise to allergies in conjunction with repeated skin contact. Avoid contact with the skin, use protective equipment.
- When in use, the machine can generate dust and fumes that can contain harmful chemicals. Know the nature of the material being worked on and wear appropriate dust mask or respirator protection.
- A face mask is especially important when working indoors due to the limited ventilation. In some situations it can also be suitable to apply water in order to decrease the dust.
- Do not stand on the control cable or the power cable as there is a risk of your feet becoming tangled.
- Do not use remote control with cable control while working or moving where there is a risk that the machine can overturn. The operator must be disengaged from the machine in such conditions.
- An incorrect manoeuvre or unforeseeable incident can result in collapse of work object. Never stand underneath the work object.
- Never stand where there is a risk of being crushed by the machine. The machine can rapidly change position while working. Never stand underneath a raised arm, even if the machine is turned off.

- When the machine is powered, the fan of the radiator may begin to rotate. Never put your fingers inside the fan compartment!
- Reduce the risk when working alone by making sure that an emergency alarm is available via mobile phone or other equipment.
- When moving on a flat surface you must always walk behind or at the side of the machine. When working or moving on an inclined surface, position yourself above the machine.

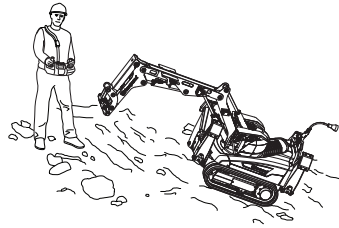

Operation

General

- Only professional and trained operators are permitted to operate the machine and its tools.
- Never use a defective machine. Carry out inspections, maintenance and service in accordance with the instructions in the Operator's Manual.
- Rectify any faults or damage that occur immediately. Prevent the machine from being used before the fault has been rectified.
- If the machine becomes inoperable, turn off the motor before approaching the machine.
- The machine has been tested and approved solely with equipment supplied and recommended by the manufacturer.
- Under no circumstances should you modify the original design of the machine without approval from the manufacturer. Always use original spare parts. Unauthorized modifications and/or accessories may lead to serious injury or death to the user or others.
- Do not modify the machine's safety devices and check regularly that they are working properly. The machine must not be driven if protective plates, protective covers, safety switches or other protective devices are not fitted or are defective.
- Make sure all nuts and bolts are tightened correctly.
- The machine must be kept clean. Signs and stickers must be fully legible.
- Follow the machine's and the tool's instructions carefully when changing tools in order to avoid injuries.
- Turn off the power supply to the machine before you take the remote control off or when you leave the machine to avoid the risk of unintentional operation.
- Firm handling of the joysticks does not make the machine stronger or faster. On the contrary, the

SAFETY INSTRUCTIONS

joysticks can buckle with unnecessary repairs as a consequence.

- Do not lift the remote control by the joysticks.

Education and training

New operators must be trained by experienced operators with the capacity to use sound judgement when supervising the work.

- Practice stopping the machine and locating the stop button quickly. Practice maneuvering in different directions, on a slope and different surfaces.
- Test the machine's stability under controlled conditions. Practice rapid evacuation.
- On completion of the training, the operator should be properly acquainted with the machine's limitations with respect to reach, capacity and stability, and also be able to maneuver the machine safely.

Maneuvering

General

- If several machines are used at the same workplace there is a risk of mixing up the remote controls.
Switch on the power to the remote control and the machine. Press the horn to see which machine is connected to the remote control. The machine will beep and flash three times. Do not activate the remote control before you have ensured that the correct machine is being operated.
- Wait until the remote control has been turned off and the motor has stopped before you enter into the machine's risk area.
- Never leave the machine unsupervised with the motor running.
- The machine can overturn during work. During operation the machine must be positioned as level as possible and the outriggers must be fully extended.
- In some cases it can be difficult to determine which end of the machine is the front and which is the rear. Look at the direction markings on the sides of the machine's tracks to avoid incorrect operation.
- When work is finished, operate the arm to rest against the ground before turning off the machine.

Outriggers

- When the outriggers are folded, the arm must be retracted to minimize the risk of the machine overturning.
- The machine's outriggers can leave the ground, especially when working with a hydraulic hammer or bucket. The higher the machine rises the greater the load the rest of the support mechanism is subject to.
- When working with a hydraulic breaker there is an increased risk of the machine tipping or landing with a large force on the outrigger on impact. Take this risk into account and institute appropriate safety measures to avoid any personal injury or mechanical damage.

Rotation function

- If there is a breakdown in the machine's rotation mechanism the machine's upper part may rotate freely, potentially causing personal injury or mechanical damage. Keep your distance.
- The machine is most stable when working directly forwards or backwards. When the machine's upper part rotates to the side, the outriggers should be down and the arm system maneuvered so that it is as close to the ground as possible.
- In some cases it can be difficult to predict the direction of rotation. Operate the turning motion carefully until you have apprehended the direction of rotation.

Arm system

- Do not use the arm system and the rotation function for striking, demolishing or scraping.
- Do not work with the arm if the machine's outriggers are folded. The outriggers provide stability and reduce the risk of the machine tipping.
- When the arm system's reach is being used, the load increases as does the risk of tipping. Position the machine as close to the working object as possible.
- Do not secure the machine to fixed objects, e.g. walls, to increase the force on the working object. Both the machine and the tool can be subject to overloading.

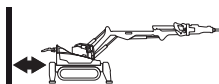

- Do not work with the machine's cylinders in the inner or outer end positions to avoid overloading. Leave a few centimetres to the end position. The hydraulic oil then has a greater capacity to alleviate impacts and vibrations.
- There are two working positions that put a lot of strain on individual cylinders.

Cylinders 1 and 2 are in their outer positions and the breaker is working in the upward direction. Never operate the cylinders to their end positions.

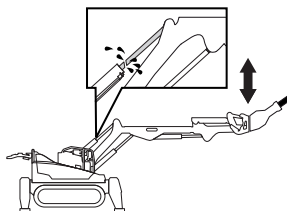

SAFETY INSTRUCTIONS

Cylinder 3 is in its outer position and the breaker is working in the downward direction. Never operate the cylinders to their end positions.

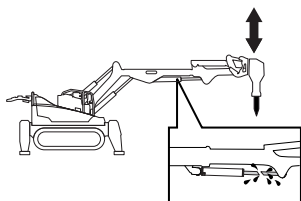

Proximity to edges

- Inadequate surfaces, incorrect operation, etc. can cause the machine to slide. Exercise particular caution when working close to shafts, beside trenches or when working at height.
- Always anchor the machine and loose tools when working close to edges.
- Ensure that the machine is stable and does not move closer to the edge while work is in progress.
- Ensure that the underlying surface has satisfactory bearing capacity. Vibrations affect bearing capacity.

Uneven surfaces

- Extend the outriggers so that they are positioned just above the surface when moving over uneven areas.
- In some cases the arm can be used to lift the drive gear over bumps. The arm must never be rotated or raised up high due to the risk of overturning.
- Uneven surfaces can cause the machine to lean to such an extent that it overturns. Maneuver the machine's arm system inwards in order to move the center of gravity as close to the machine's center as possible to reduce the risk of tipping.
- Surfaces with a poor bearing capacity can cause the machine to change direction or even overturn without warning. Always check the bearing capacity and properties of the surface before starting the machine. Also be alert for holes that are covered by materials with a poor bearing capacity.
- The machine's caterpillar tracks produce a low level of friction against smooth surfaces. Water, dust and contaminants can further reduce friction. When defining the risk area you should take into account the fact that less friction increases the risk of the machine starting to slide.

Confined spaces

- Working in confined spaces with extended outriggers can be difficult. The machine's stability is considerably diminished. Adapt the work accordingly. There is an increased risk of the machine overturning if the arm swings outside the outrigger.

Inclined ground

- Inclined surfaces, stairs, ramps etc. can constitute major risks when moving and working. With gradients

in excess of 30° in the machine's lengthwise direction there is a risk of the machine tipping.

- The machine's arm system and outriggers must be positioned as low as possible to reduce the risk of tipping.
- Do not run the caterpillar tracks and tower simultaneously when moving on an inclined surface to reduce the risk of unexpected motion.
- Avoid driving sideways on slopes - drive straight up or down. Ensure that the machine's arm system is turned upwards in inclined terrain.
- Always position yourself above the machine when driving on a slope. There is a risk of the machine tipping.
- Anchor the machine if there is a risk of the machine starting to move involuntarily.
- Check that there is sufficient bearing capacity when driving on ramps and stairs.

Proximity to ducts and pipes

- Always check and mark where electricity cables and pipelines are routed. Ensure that electricity cables and pipelines are shut off.
- The machine must not get close to overhead power lines.

Falling material

- Watch out for demolition material becoming loose when working. Use personal safety equipment and keep your distance.
- Ensure that the vibrations from the hydraulic breaker do not cause cracks to form or stones or other material to loosen and cause personal injury or damage to property. Keep your distance!

Transport and storage

Lifting the machine

- When lifting the machine there is a risk of injuring persons or damaging the machine or the surroundings. Define the risk area and check that nobody is present within the area when lifting.
- Use an approved lifting device to secure and lift heavy machine parts. Also ensure that there is equipment to secure machine parts mechanically.
- Retract the arm system. The center of gravity must be as close to the machine's center as possible.
- The lifting equipment must be attached at all the machine's lifting points.
- Lift slowly and carefully. Make sure that the lift is in equilibrium and if the machine starts to lean, rectify it by using an alternative lifting device or change the position of the arm system.
- Ensure that the machine's parts are not crushed or damaged when lifting and that the machine does not hit surrounding objects.

SAFETY INSTRUCTIONS

Loading and unloading using a ramp

- Ensure that the ramp is intact and the right size for the machine.
- Check that the ramp is free of oil, mud or anything else that might make it slippery.
- Ensure that the ramp is properly secured to both the vehicle and the ground. The vehicle being used for transportation must also be secured so that it cannot move.

Transport

- The machine may only be transported on a flatbed truck or a trailer that is approved for the machine's weight, refer to the machine's rating plate. The remote control must be properly protected in the vehicle during transportation.
- Check applicable road traffic regulations before transporting on public roads.

The machine's position on the loading platform

- Position the machine against the front edge of the platform in order to reduce the risk of it sliding forward if the vehicle brakes.
- Maneuver the arm system so that it is resting against the platform, positioned as low as possible. Extend the outriggers without lifting the machine.

Securing the load

- Secure the machine with approved tightening straps. Ensure that no part of the machine are squashed or damaged by the tightening straps. It is a good idea to cover the machine.

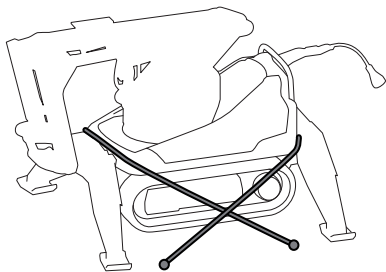

- Tools and other equipment must be secured with separate tightening straps.
- Regularly check that the load is secure during transportation.

Storage

- Remove the tool from the machine.
- Retract the arm system to attain a center of gravity that is as low as possible and to save space.
- Store the equipment in a lockable area so that it is out of reach of unauthorized persons.
- Store the machine and its equipment in a dry and frost proof place.

- The main switch on the machine can be locked with a padlock to prevent unauthorized persons from starting the machine.

Towing

The machine is not designed to be towed. When the hydraulic system is discharged, the drive motor's parking brakes are activated and the caterpillar tracks cannot rotate. Only tow the machine if its position constitutes a risk and there is no other solution. Tow it for the shortest possible distance.

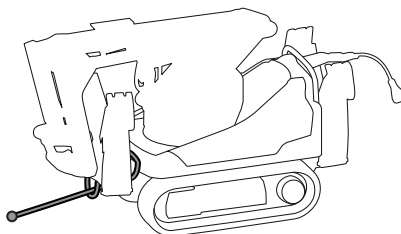

- If possible, retract the outriggers before towing the machine in order to reduce the risk of damaging them.
- To minimize the load on the towing device and mechanical components, reduce the friction by preparing the route that the machine is going to be towed.
- If possible tow in the direction of the tracks.
- Use a towing device intended for the particular load.
- Parts can loosen during towing. Keep your distance!

Maintenance and service

Most accidents involving machines occur during trouble shooting, service and maintenance as staff have to locate themselves within the machine's risk area. Prevent accidents by being alert and by planning and preparing the work. You can also refer to 'Preparations for maintenance and service' in the 'Maintenance and service' section.

- Never carry out repairs without having the necessary expertise.
- The user must only carry out the maintenance and service work described in this manual. More extensive work must be carried out by an authorized service workshop.
- Use personal protective equipment as well as equipment to mechanically secure machine components during maintenance and service.
- Only trained service personnel are permitted to intervene in the electrical or hydraulic systems.
- Set out clear signs to inform persons in the vicinity that maintenance work is in progress.
- If service operations or trouble shooting does not require the machine to be switched on, the power cable must be removed and positioned so that it cannot be connected by mistake.

SAFETY INSTRUCTIONS

- Ensure there is no power supply to the machine by removing the power cable before opening or removing the electric cabinet or any other electric component.
- Pipe and hose couplings can remain pressurized despite the motor being switched off and the power cable disconnected. It must always be assumed that hydraulic hoses are pressurized and they must be opened with great care. Relieve the pressure on the arm system by resting it on the ground, turn off the electric motor and discharge the hydraulic system before undoing the hoses.
- Never try to stop hydraulic oil leaking from a broken hose by hand. Finely dispersed hydraulic oil at high pressure can permeate under the skin and cause very severe injuries.
- When dismantling machine parts, heavy components can start moving or fall down. Secure moving parts mechanically before loosening screw joints or hydraulic hoses.
- Use an approved lifting device to secure and lift heavy machine parts.
- Several components heat up during use of the machine. Do not commence any servicing or maintenance tasks until the machine has cooled down.
- **Keep work area clean and well lit.** Cluttered or dark areas invite accidents.
- The machine's movements can be defective if a terminal, cable or hose is incorrectly assembled. Exercise caution during test runs and be prepared to turn off the machine immediately in the event of a fault.

External environmental factors

Temperature

The ambient temperature, both hot and cold, affects the machine's operational reliability. Temperature variations also have an impact as they produce an increased risk of condensation forming in the machine's tank.

Heat

NOTICE! There is an increased risk of overheating in warm environments. Both the machine's hydraulic system and electronic components can be damaged.

The maximum working temperature for hydraulic oil is 90°C (194°F). Overheating results in deposits forming in the oil, leading to increased wear, damaged seals and leakage. Overheated hydraulic oil provides poor lubrication, resulting in inferior performance.

To avoid overheating:

- Keep the machine clean, in particular its cooler.
- Ensure that there is good ventilation when working indoors.

- Radiant heat can cause local heating that damages parts of the machine. Screen off vulnerable components.
- Additional cooling is required if the ambient temperature is over 40°C (104°F).

To avoid damage to the machine:

- Change hydraulic fluid and filters more frequently.
- Check the machine's seals to prevent dirt in the hydraulic system due to broken seals.
- Rubber caterpillar tracks must not be exposed to temperatures of over 70°C (158°F). In hotter environments steel tracks have to be used.

Cold

Do not use maximum pump pressure if the hydraulic fluid is less than 10°C (50°F). Allow the machine to warm up slowly. Warm up the lower section by running the caterpillar tracks, first slowly and then more quickly with the outriggers extended. Move the upper section back and forth and operate all cylinders in the arm system without load. The machine is ready for use when its temperature (hydraulic fluid) has risen to around 40°C (104°F).

Moisture

When working in damp environments the operator should ensure that electrical components, connectors for example, are not submerged in water.

The machine must never be driven to such a depth in water that it reaches up to the machine's equipment. The equipment can be damaged and the machine can be live, resulting in personal injuries.

Dust and particles

Dust and particles can block the machine's cooler, cause overheating and increase wear on the machine's bushings and shafts. Clean and lubricate the machine regularly.

The hydraulic system is extremely sensitive to contaminants. Small particles can cause breakdowns and increase wear in the components.

There is a high risk of contamination in conjunction with servicing and repairs when the hydraulic system is opened.

Contamination of the hydraulic system can be prevented by:

- Keeping the machine clean, particularly before servicing, repairs or changing tools.
- Carrying out daily inspections.
- Carrying out regular servicing.

STARTING AND STOPPING

Before starting

The following points should be checked when working at a new site and every morning before starting:

- Carrying out daily inspections.
- Examine the machine for transport damage.
- Check that the machine's safety features are intact. Refer to "Machine's safety equipment" chapter.
- Check that the power cable and operating cables are intact and correctly dimensioned.
- Check that the mains voltage is compatible with the machine and that the correct fuses are used.
- Always connect the machine through a ground fault circuit interrupter with personal protection, i.e. a ground fault circuit interrupter that trips at a ground fault of 30 mA.
- Make sure the emergency or machine stop button is reset.
- Check that no tools or other objects have been left lying on the machine.

Starting

Connect the machine

- Connect the machine to a 3 phase power supply.
- Turn on the main switch on the machine.

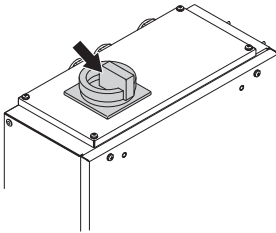

Starting the remote control

- Turn the switch to the ON position (I). In this position the remote control is supplied with power. The light emitting diode on the remote control flashes rapidly with a blue light when it is searching for contact. When it flashes with a longer interval the machine is in standby mode.

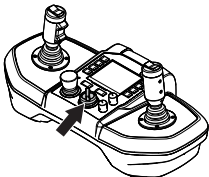

- If a function is not working or needs attention, an error message appears on the display in conjunction with start-up. Refer to "Error messages" in the "Trouble shooting" section.

Starting the electric motor

- Step out of the machine's risk area with the remote control.
- The electric motor is started by pressing the start button.

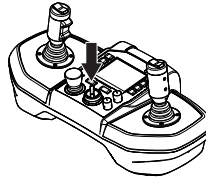

- If several machines are used at the same workplace there is a risk of mixing up the remote controls.
Press the horn to see which machine is connected to the remote control. The machine will beep and flash three times. Do not activate the remote control before you have ensured that the correct machine is being operated.

Activating controls

To activate the remote control's operating functions, press the left button or the thumb switch downwards on the right joystick. The remote control is now work mode. The light emitting diode on the remote control has a permanent blue light.

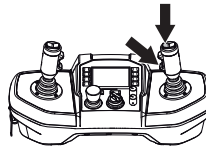

- If no command is given within three seconds the operating functions are locked. To reactivate control functions, press the left button on the right joystick.
- The joystick must be in neutral position.

Stopping

- Maneuver the arm system down and allow it to rest against the ground.
- Set all controls into neutral position.
- Press the stop button and switch off the remote control.
- Step inside the risk area and turn the main switch into the OFF position (0).

Inspection after work

It can be beneficial to carry out the daily inspection after finishing work. Detecting damage in time can prevent a shutdown on the following day.

OPERATION

Operating modes

The machine can be operated in two different modes: transport mode and work mode. All commands in each of the modes are described in this section and under the heading "Joysticks functions" in the Settings section.

Work mode

In this mode you can operate everything except the caterpillar tracks and outriggers.

Transport mode

This mode is divided into 3 submodes.

- One hand: Caterpillar tracks, outriggers, tower and certain arm functions can be operated. Caterpillar tracks are fully controlled by left joystick.
- Two hand: Caterpillar tracks and outriggers can be operated. Caterpillar tracks are controlled individually with each joystick.
- Crawl: Caterpillar tracks, tower and all arm functions can be operated. Caterpillar tracks are operated by the left joystick button. It's only possible to move straight forward or backward. Speed can be controlled with the tool speed potentiometer.

If no controls have been used for 3 seconds, the machine will go to circulating pump mode. In this mode, the hydraulic oil is pumped to the tank and there will be no pressure in the cylinders.

If a new mode is selected while any joystick is activated, the machine will go into idle mode, where no movement is possible. The new mode will become active when the joysticks are no longer activated.

Key to commands

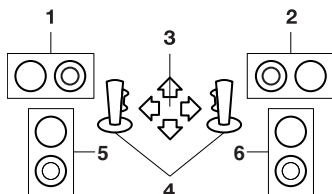

- 1 Right and left button on left joystick
- 2 Right and left button on right joystick
- 3 Direction joystick
- 4 Left and right joystick respectively
- 5 Left thumb switch (see Settings - Joystick setup)
- 6 Right thumb switch (see Settings - Joystick setup)

Designation of the machine's parts

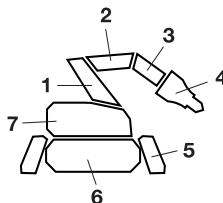

- 1 Arm 1
- 2 Arm 2
- 3 Arm 3
- 4 Tools
- 5 Outriggers
- 6 Caterpillar tracks
- 7 Tower

OPERATION

Pattern description

The operating modes used as default apply either to joystick pattern SAE or are generic.

SAE joystick pattern

Work mode

Rotate tower counter-clockwise



Rotate tower clockwise



Arm 1 in



Arm 1 out



Arm 2 up



Arm 2 down



Arm 1 and arm 2 in



Arm 1 and arm 2 out



Arm 3 up

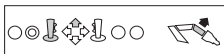

Arm 3 down

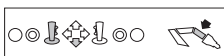

Angle tool inwards*



Angle tool outwards*



* The function works even if the right button on the right joystick is depressed. This can be useful if you simultaneously want to run arm 1 and 2 in parallel.

Transport mode - Two hand

Track operation

Right caterpillar track forward



Right caterpillar track backwards



Left caterpillar track forward

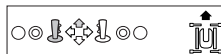

Left caterpillar track backwards



Outriggers

Right outrigger up



Right outrigger down



Rear right outrigger up



Rear right outrigger down



Front right outrigger up



Front right outrigger down



Left outrigger up

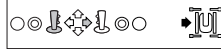

Left outrigger down



Rear left outrigger up



Rear left outrigger down



Front left outrigger up

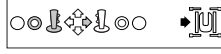

Front left outrigger down

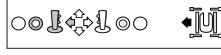

OPERATION

Transport mode - One hand

Right track forward, left track backwards



Right track backwards, left track forward

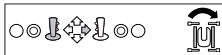

Rotate tower counter-clockwise



Rotate tower clockwise



Caterpillar tracks forward

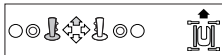

Caterpillar tracks backwards

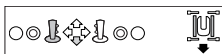

All outriggers up

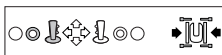

All outriggers down



Arm 2 up



Arm 2 down



Arm 1 and arm 2 in



Arm 1 and arm 2 out



Arm 3 up



Arm 3 down



Angle tool inwards*



Angle tool outwards*



* The function works even if the right button on the right joystick is depressed. This can be useful if you simultaneously want to run arm 1 and 2 in parallel.

Transport mode - Crawl

Rotate tower counterclockwise

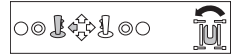

Rotate tower clockwise

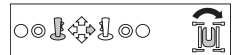

Arm 1 in



Arm 1 out



Arm 2 up



Arm 2 down



Arm 1 and arm 2 in

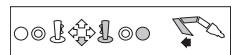

Arm 1 and arm 2 out

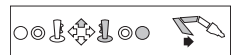

Arm 3 up

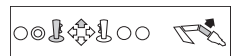

Arm 3 down

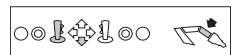

Angle tool inwards*



Angle tool outwards*



Caterpillar tracks forward **

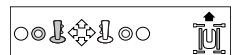

Caterpillar tracks backwards **

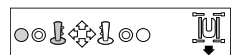

* The function works even if the right button on the right joystick is depressed. This can be useful if you simultaneously want to run arm 1 and 2 in parallel.

** The speed of the caterpillar tracks can be adjusted with the tool speed potentiometer.

OPERATION

Generic joystick pattern

Work mode

Adjustable pressure/flow to hydraulic tool (breaker/cutter)

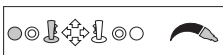

Full pressure/flow to hydraulic tool (breaker/cutter)

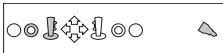

Cutters open/close**



Adjustable flow to drum cutter

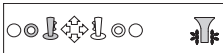

Limited flow, backwards rotation, to drum cutter

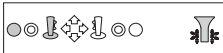

** The button that opens/closes the cutters varies depending on which type of cutters that are used.

Work mode, extra function

For activation, see instructions in the "Settings" section under the heading "Extra functions".

Extra 1, direction 1



Extra 1, direction 2



Extra 2, direction 1



Extra 2, direction 2



If joystick setup is set to Auto or Extra 1/Extra 2.

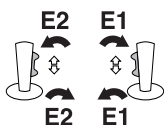

TOOLS

General



CAUTION! Please read the operator's manual carefully and make sure you understand the instructions before using the machine. You should also read and understand the manual that accompanies the tool.

Ensure that the tool's and the machine's performance (weight, hydraulic pressure, flow etc) are compatible.

The machine may only be used with the following tools or accessories marketed by Husqvarna.

Bucket

A bucket is intended for moving material and not as a lifting tool.

Bucket, standard 55 L

The toothed bucket is for digging e.g. soil with grass and roots.

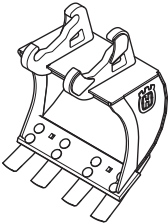

Narrow bucket 40 L

The bucket's design is suitable for work such as the laying of pipe.



Wide bucket 60 L

The wide bucket is suitable for shoveling large masses of material such as when clearing rubble after demolition.

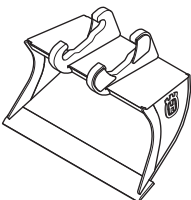

Hydraulic breaker SB 152

The hydraulic breaker is designed for demolition by means of hewing. It is not designed for use as a crowbar. Continuous hewing with the hydraulic hammer can result in high temperatures in the hydraulic system.

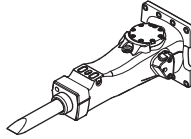

Concrete crusher DCR100

The concrete crushers are designed to crush and cut material in their jaws. They are not designed for pulling and prizing loose material.

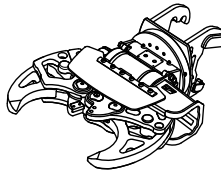

Steel Shear DSS200

The steel shears are intended to cut metallic materials with their jaws. They are not designed for pulling and prizing loose material.

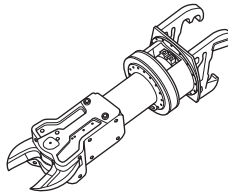

Grapple MG100

The grippers are intended for demolishing wooden structures and brick walls, sorting and loading work. It is not intended to pull/demolish beams, stays and walls. Neither is it intended to hammer/hack or transport loads.

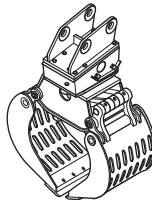

TOOLS

Drum cutter ER50

The drum cutter is designed to demolish and excavate by means of milling. It is not intended for any other material than rock, concrete, asphalt, frozen soil and ice.

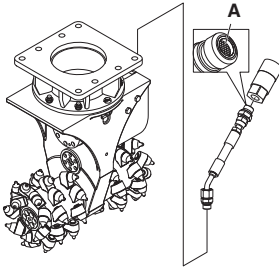

NOTICE! The drum cutter requires the additional *Tool Drain Kit* installed on the DXR because of the internal oil leakage in ER50.

NOTICE! In the *Tool Drain Kit*, there is a filter (A) in the adapter between the tube and the quick connect fitting.

External tool

External hydraulic tools can be connected to the machine. External tool is activated from the service menu. See instructions in the section "Settings".

Work mode

In the work menu you can choose to work with either a breaker or a concrete crusher. The steel shears (others) can be activated from the Work menu. See instructions in the section "Settings".

NOTICE! There is a risk of damage to the machine if, for example, the work pressure is delivered to a single-acting tool's return side, or if the machine's or the remote control's settings are not correct for the tool in question. There is more information about the remote control's settings in the 'Control system' section.

Changing tools



CAUTION! Changing tools may mean that the operator has to be within the machine's risk area. Ensure that nobody unintentionally starts the machine while the tool is being changed. Keep a sharp watch on the machine and be prepared to turn it off. Guard hands and feet against crushing.

Cleaning

Prevent dirt from entering the hydraulic system by:

- Wiping dirt off the couplings before assembling or dismantling.
- Placing dust guards on the machine's hydraulic couplings when no tool is mounted.
- Ensuring that the tool's hoses are always connected together when the tool is not connected to the machine.

Assembly



CAUTION! Ensure that the tool is correctly and securely fitted. If a tool unexpectedly comes loose it can cause personal injury.

- Ensure that the machine is situated on a stable surface with the outriggers down.
- Position the tool with the holder facing the machine at a suitable distance, not too close to the machine.
- Ensure that the tool is turned the right way round. Mount the wedge from the right with the stop notch upwards/forwards.
- Direct the tool holder so that it grips the tool. Tighten the tool by raising the arm system and manoeuvring cylinder 4 in.

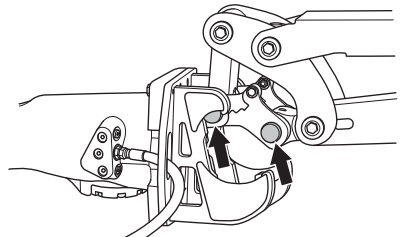

- Shut off the machine.
- Mount the wedge from the left with the stop notch upwards/forwards.
- Insert the wedge until it's fixated.

TOOLS

- Insert the locking pin into the innermost possible hole.

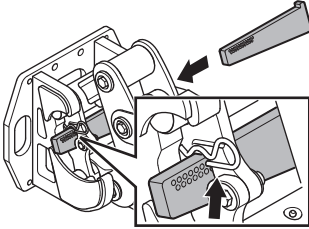

- Connect the hydraulic hoses and any hoses for breaker lubrication (when fitting the breaker). Viewed from the rear, the tool's return hose must first be connected to the right side (A port) and then the delivery hose to the left side (B port).
- The hydraulic hoses are equipped with quick couplings with decompression. This facilitates fitting the hoses even though pressure is trapped.
- To dismantle, follow the instructions in the reverse order.

Storage

Store the tools safely and inaccessible to unauthorised people. Ensure that they are in a stable position and cannot tip over. If tools are placed high up or on a slope they must be secured so that they cannot be put into motion or fall. Protect the hydraulic couplings of the tools against dirt and damage.

ACCESSORIES

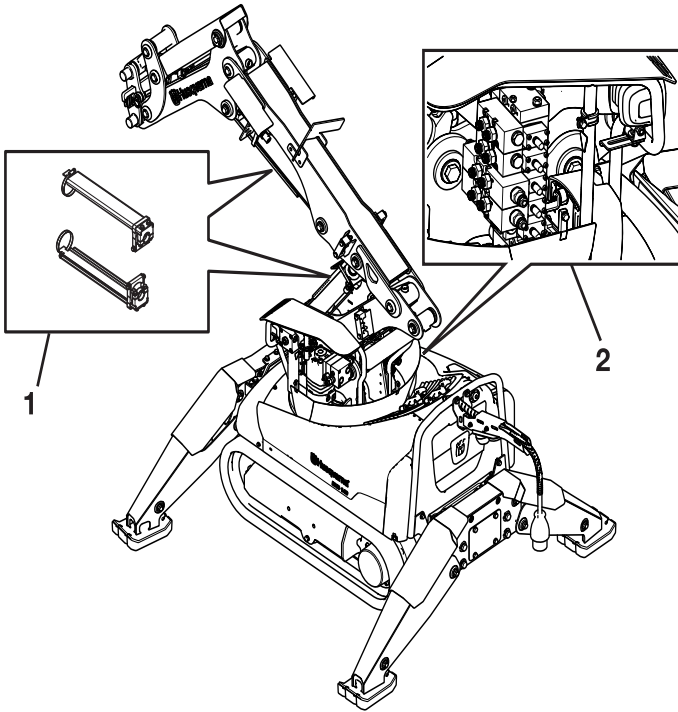

Accessory kits

P1 - Hydraulic feature

Cylinder guard (1)

Cylinder guard to protect the piston and cylinders in cylinder 2 and cylinder 3.

Additional hydraulic function (2)

The additional hydraulic function makes it possible to rotate various tools.

ACCESSORIES

Tool drain kit

Enables transportation of internal oil leakage from the ER50 drum cutter back to the hydraulic tank in the DXR. The hose kit can be used with other tools that require transportation of internal oil leakage.

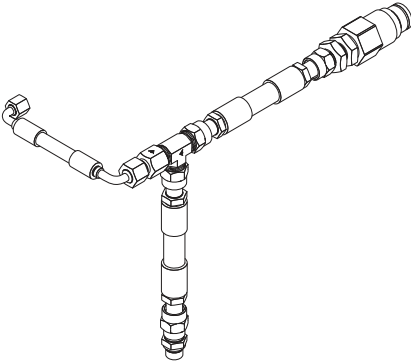

Dust reduction kit (Water)

The dust reduction kit is used for reducing the amount of airborne dust.

Mounted on DXR

The kit provides water to the tool.

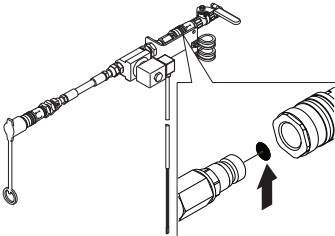

Daily inspect the nipple coupling **mesh filter**, clean when needed.

Mounted on SB152

The kit projects a water mist towards the working area.

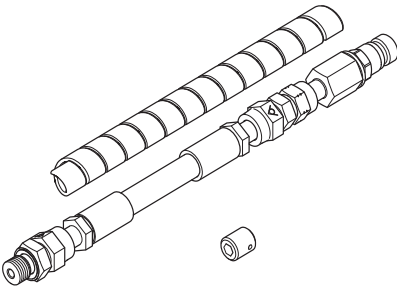

ACCESSORIES

Service check

This service check works only on generation 2-* and 3-* machines. The service check comprises two connectors, K22 (A) and K23 (B), and a control unit (C).

*switch S1 on the electric cabinet must be in position 2.

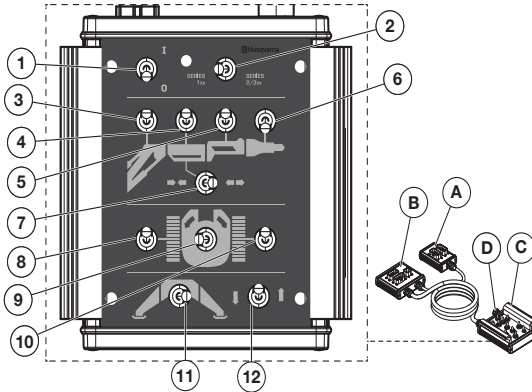

What is what on the control unit?

The control unit has a machine stop (D) and 12 toggle switches with various functions.

- 1 On/Off (I / O)
- 2 Mode selector
- 3 Arm 1 (out/in)
- 4 Arm 2 (up/down)
- 5 Arm 3 (up/down)
- 6 Angle tool (inwards/outwards)
- 7 Telescopic arm (out/in) (Only valid for DXR310)
- 8 Caterpillar tracks, left (forward/back)
- 9 Tower (rotation)
- 10 Caterpillar tracks, right (forward/back)
- 11 Outrigger, active
 - Left - left side (x2)
 - Center - all
 - Right - right side (x2)
- 12 Outrigger, move (up/down)

The service check is used only for moving the machine to service.

The machine must be in drivable condition. The service check replaces only the control system and remote control.

NOTICE! The service check is not for working with and tools can not be activated.



WARNING! Nobody, except the operator, is permitted to be within the machine's risk area while moving of the machine is underway. The machine's risk area varies while moving depending on ground conditions etc. Study the possible risks before starting to move the machine. If conditions change while moving the machine, you must redefine the risk area.

ACCESSORIES

Connect the service check

- Unscrew the protective covers and lift them off. Unscrew the covers over the control modules and remove them.
- Connect service check by transferring the connectors from the machine's control modules K23 (3 outlets) and K22 (2 outlets) to the corresponding contacts on service check.

SERIES 1XX

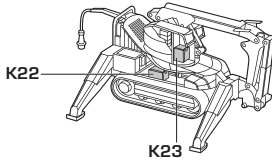

The light on the service controller comes on when everything is connected correctly.

- Choose the type of machine that service check is to control.
 - SERIES 1xx - DXR140
 - SERIES 2/3xx - DXR250, DXR270, DXR300, DXR310
- Put the I/O switch to 'I'. The machine's lighting comes on.
- See earlier overview for maneuvering via service check.

SETTINGS

Menu overview

Display texts are illustrated in English in the manual, but will appear in the chosen language on the product display.

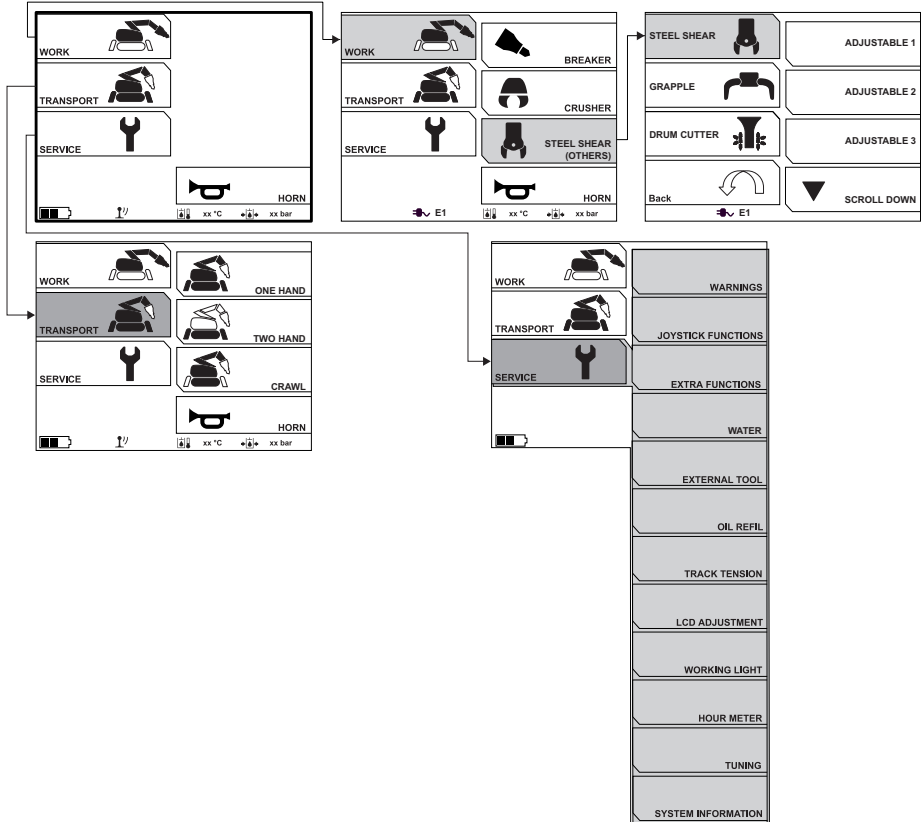

Operational settings

Work

BREAKER



Select this when you want to work with a breaker. Press the selection key to confirm the choice.

CONCRETE CRUSHER



Select this when you want to work with a concrete crusher. Press the selection key to confirm the choice.

SETTINGS

STEEL SHEAR (OTHERS)



Select this when you want to work with steel shear, grapple or adjustable tools. Press the selection key to confirm the choice.

Steel Shear



Select this when you want to work with a steel shear. Press the selection key to confirm the choice. Extra1 will be activated automatically for the rotor function when steel shears are selected.

Grapple



Select this when you want to work with a grapple. Press the selection key to confirm the choice. Extra1 will be activated automatically for the rotor function when grapples are selected.

Drum Cutter



Select this when you want to work with a drum cutter. Press the selection key to confirm the choice.

Adjustable

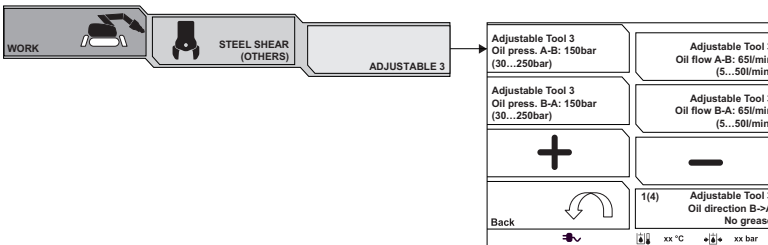

Select this when you want to work with a tool that is not a standard tool.

The value for oil pressure and oil flow can be adjusted from port A to B. Select which setting you would like to change with the selection keys. Use the arrow keys to change the value.

The oil direction can either be one-way – with or without grease (e.g. when working with a breaker) or two-way – with or without grease (e.g. when working with a crusher). Press the selection key to switch to another mode.

Transport

- One hand
- Two hand
- Crawl

SETTINGS

Service

WARNINGS

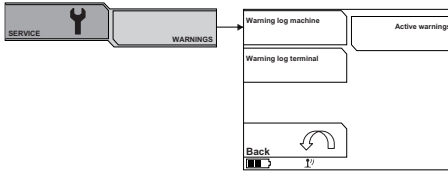

The machine has 2 warning logs and a list of active warnings.

- Warning log machine: Records all warnings that have been present in the machine. All active warnings and service messages are listed after they have been confirmed.
- Warning log terminal (remote control): Records all warnings that have been present in the remote control (terminal). All active warnings and service messages are listed after they have been confirmed.
- Active warning: Shows all active warnings. They will remain in the list for as long as they are active.

All warnings are sorted according to the hour meter registers when they occurred. The newest warning is showed first and the oldest is last.

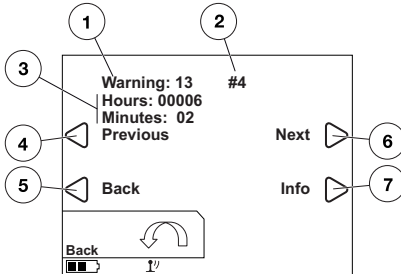

- 1 Warning code: Identifies the kind of warning that has been registered.
- 2 The number of times the warning has been present in the system.
- 3 Registered working time when the warning last occurred.
- 4 Previous warning in the warning log.
- 5 Exit the warning log.
- 6 Next warning in the warning log.
- 7 More information about the warning.

JOYSTICK FUNCTIONS

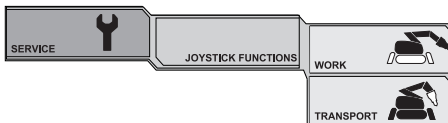

Choose Operating mode to see a description of the chosen joystick pattern.

SETTINGS

EXTRA FUNCTIONS (optional)

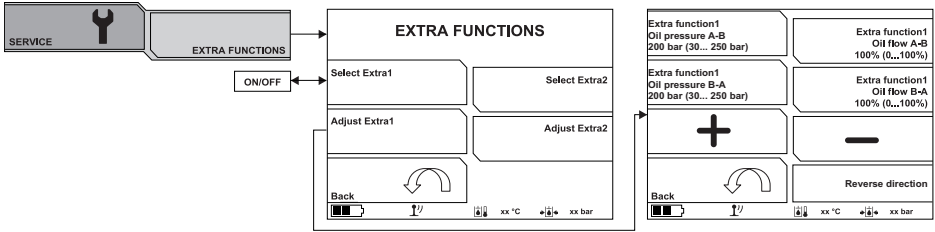

The machine can be equipped with extra valves to make it capable of running more functions, such as a rotor and a tilt. The value for oil pressure and oil flow can be adjusted from port A to B and vice versa. Select which setting you would like to change with the selection keys. Use the arrow keys to change the value.

At activation, the selected extra function (E1/E2) will appear in the symbol field at the bottom of the display. The symbol will remain for as long as the function is active.

The direction of the additional function is switched by activating reverse direction.

WATER (optional)

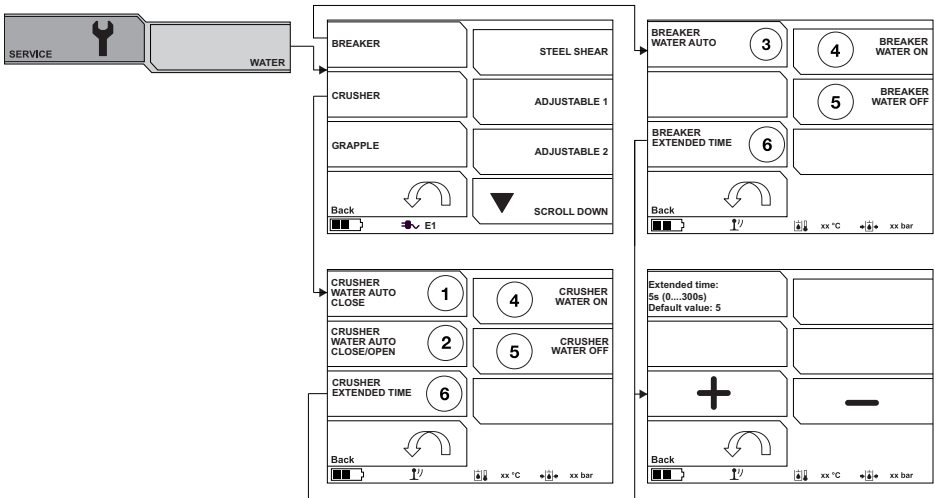

DXR equipped with a Dust Reduction kit enables the water function. The function can be activated together with various tools.

- 1 Crusher Water Auto Close - the water supply is applied automatically when the crusher closes.
- 2 Crusher Water Auto Close/Open - the water supply is regulated automatically (on/off) by the usage of the crusher.
- 3 Breaker Water Auto - the water supply is regulated automatically (on/off) by the usage of the breaker.
- 4 Breaker/Crusher Water On - constant water supply from first activation of machine until machine's motor is turned off or usage of another tool.
- 5 Breaker/Crusher Water Off - the water supply is closed.
- 6 Breaker/Crusher Extended Time - extended water supply after the breaker/crusher goes into stand-by mode.

As long as the water function is active, a water drop symbol will appear together with the selected tool.



SETTINGS

EXTERNAL TOOL

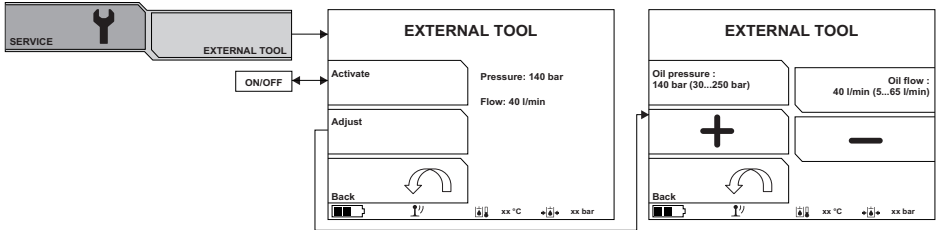

The machine can be used as a power source to operate external hydraulic tools.

The value for oil pressure and oil flow can be adjusted from port A to B. Select which setting you would like to change with the selection keys. Use the arrow keys to change the value.

OIL REFILL

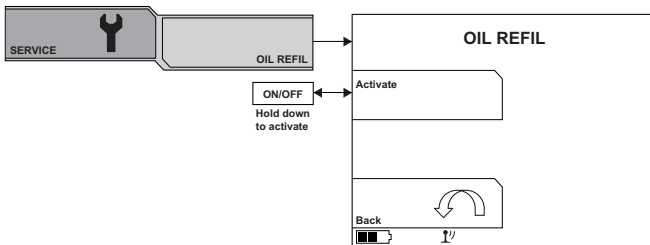

The gauge shows the oil level in percentage with even tens. Hold the selection key down to refill oil. The pump will shut off automatically when the tank is full.

TRACK TENSION

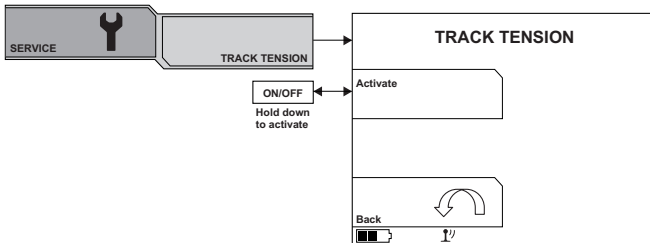

Hold the selection key down to activate the track tension.

LCD ADJUSTMENT



Use the arrows up and down to adjust the display's contrast and brightness. To keep the display continuously on, set Power save mode to OFF.

WORKING LIGHT



Activates/shuts off the work lighting. Press the selection key to switch to another mode.

SETTINGS

HOURL METER

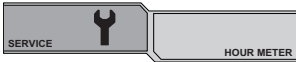

The operating hours for the machine (the time when the motor is on) are saved in the control modules and can be read in the terminal.

When the remote control (terminal) is connected to the machine, can the operating hours be read in online mode.

When the remote control (terminal) is disconnected to the machine the operating hours can be read in offline mode.

Measurement refers to the operating hours when the current control is connected to the machine. If the machine has been operated with another control, the information concerning operating hours will not be correct.

TUNING

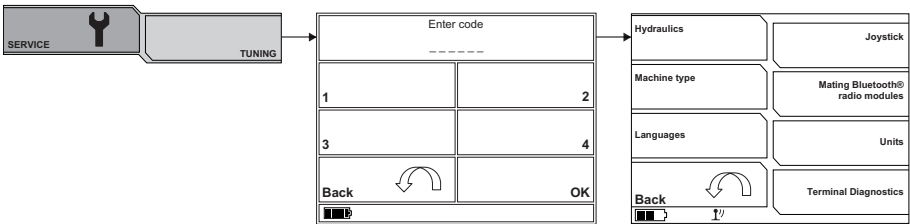

Enter the 6 digit code to proceed to settings.

HYDRAULICS

The following components can be adjusted:

- Auto adjust
- C1-C4, C1/C2
- Track R
- Tool
- Extra 1
- Extra 2
- Boom pressure

The selection "Reset system settings" resets all values to their basic setting.

- Rotation
- Outriggers/dozer blade
- Track L

Auto adjust

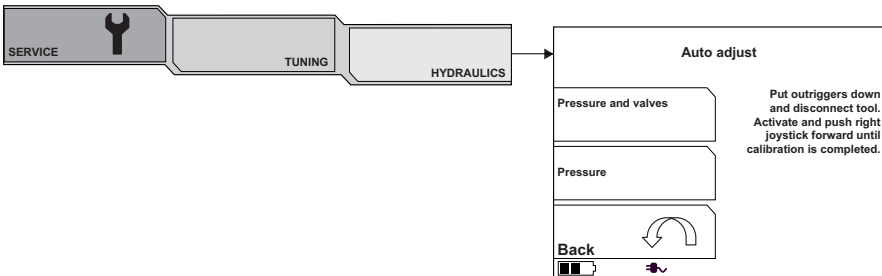

For auto adjustment, the machine should be standing on the outriggers and the tool should be disconnected.

SETTINGS

Choose to calibrate "pressure and valves" or just "pressure". Valve calibration will improve the control of machine movements. Pressure calibration will improve the accuracy of hydraulic pressure levels.

The machine will make small movements during valve calibration, which is normal.

"Pressure" will only calibrate pressure control function, without making any changes to customer specific tuning of valves.

To start auto adjustment:

- Start the motor.
- Activate the machine.
- Push right joystick forward, until calibration is completed.

C1-C4, C1/C2

RAMP UP/DOWN

Ramp adjusts the acceleration of the drive.

A high up-value means slow acceleration.

A low up-value means quick acceleration.

A high down-value means slow braking.

A low down-value means quick braking.

MAX-/MIN CURRENT

Max./min. current indicates the current interval that controls the prop. valve. A too high minimum value means that the valve opens rapidly. This might mean that it is not possible to employ a function gently.

A low minimum value will increase the deadband of the control lever around the central position.

A low maximum value means that the valve does not open entirely and that the function cannot be run at maximum speed.

A high maximum value means that the valve's maximum opening position is achieved more rapidly. This will impair resolution of the movement.

Track R

Tool

Extra 1

Extra 2

Boom pressure

The Boom pressure can be decreased from the maximum 200 bar to 150 bar. The pressure changes with 5 bar intervals.

JOYSTICKS

Settings for adjusting the function of the control levers.

Joystick tuning

JOYSTICK PRECISION

Settings to adjust the precision.

- Default precision - standard setting.
- Enhanced precision at high speed - typically used when a high and even speed is essential through out the entire joystick movement, e.g. when digging.
- Enhanced precision at low speed - typically used when high precision at low speed is essential e.g. when working with precision tools such as Grappler or Steel Shear (MG 100/200 or DSS200).

THUMB SWITCH PRECISION

DEAD BAND

Deadband indicates the position in which the joysticks start to be activated. The higher the value the farther out from neutral position that the joysticks are activated.

- Joystick
- Thumb switch

SETTINGS

Joystick pattern

The joystick pattern changes the operation of the remote control. The operational pattern changes as below when the different patterns are selected.

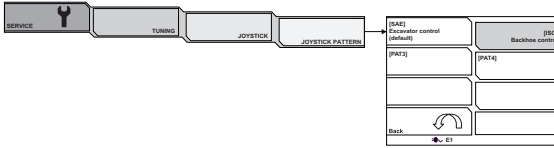

SETTINGS

JOYSTICK PATTERN - ISO

Work mode / Transport mode - Crawl

Arm 2 down



Arm 2 up

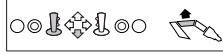

Arm 3 down



Arm 3 up



Angle tool inwards *



Angle tool outwards *



Arm 1 in



Arm 1 out



Arm 1 and arm 2 out



Arm 1 and arm 2 in



Rotate tower counterclockwise



Rotate tower clockwise

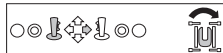

* The function works even if the right button on the right joystick is depressed. This can be useful if you simultaneously want to run arm 1 and 2 in parallel.

Transport mode - Crawl

Caterpillar tracks backwards



Caterpillar tracks forward

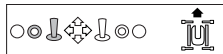

Transport mode - One hand

Arm 2 down



Arm 2 up



Arm 3 down



Arm 3 up



Angle tool inwards*



Angle tool outwards*



Rotate tower counterclockwise



Rotate tower clockwise



Arm 1 and arm 2 out



Arm 1 and arm 2 in



Caterpillar tracks forward



Caterpillar tracks backwards

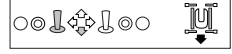

Right track forward, left track backwards

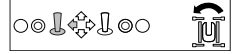

Right track backwards, left track forward



All outriggers down



All outriggers up



* The function works even if the right button on the right joystick is depressed. This can be useful if you simultaneously want to run arm 1 and 2 in parallel.

SETTINGS

JOYSTICK PATTERN - PAT3

Work mode / Transport mode - Crawl

Arm 3 up *



Arm 3 down *



Rotate tower
counterclockwise



Rotate tower clockwise



Arm 1 in



Arm 1 out



Arm 1 and arm 2 out



Arm 1 and arm 2 in



Arm 2 down

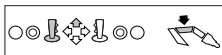

Arm 2 up

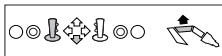

Angle tool inwards

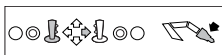

Angle tool outwards

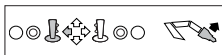

* The function works even if the right button on the right joystick is depressed. This can be useful if you simultaneously want to run arm 1 and 2 in parallel.

Transport mode - One hand

Arm 3 up



Arm 3 down



Rotate tower
counterclockwise *



Rotate tower clockwise *



Arm 2 down



Arm 2 up

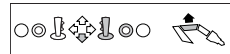

Angle tool inwards



Angle tool outwards



Arm 1 and arm 2 out



Arm 1 and arm 2 in



Caterpillar tracks forward

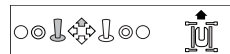

Caterpillar tracks
backwards

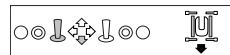

Right track forward, left
track backwards

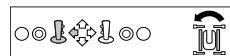

Right track backwards,
left track forward



All outriggers down

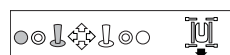

All outriggers up

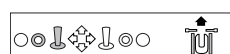

* The function works even if the right button on the right joystick is depressed. This can be useful if you simultaneously want to run arm 1 and 2 in parallel.

SETTINGS

JOYSTICK PATTERN - PAT4

Work mode / Transport mode - Crawl

Arm 3 down



Arm 3 up



Arm 2 down



Arm 2 up



Rotate tower counterclockwise



Rotate tower clockwise

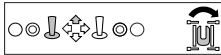

Angle tool inwards*



Angle tool outwards*



Arm 1 out



Arm 1 in



Arm 1 and arm 2 out



Arm 1 and arm 2 in



Caterpillar tracks backwards**



Caterpillar tracks forward**



* The function works even if the right button on the right joystick is depressed. This can be useful if you simultaneously want to run arm 1 and 2 in parallel.

Settings to adjust thumb switch behavior.

** The speed of the caterpillar tracks can be adjusted with the tool speed potentiometer.

Transport mode - One hand

Angle tool inwards *



Angle tool outwards *



Arm 3 up



Arm 3 down



Arm 2 down



Arm 2 up



Rotate tower counterclockwise



Rotate tower clockwise

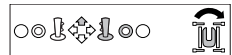

Arm 1 and arm 2 out



Arm 1 and arm 2 in



* The function works even if the right button on the right joystick is depressed. This can be useful if you simultaneously want to run arm 1 and 2 in parallel.

SETTINGS

Joystick calibration

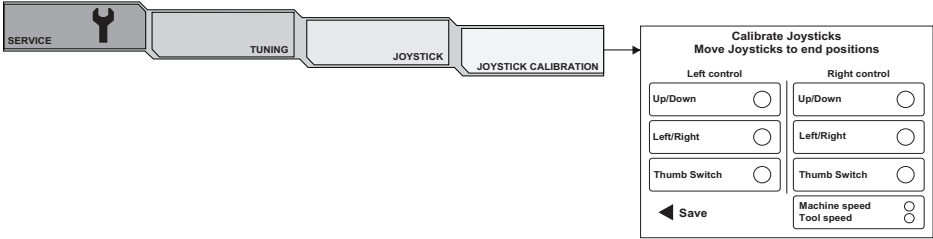

When entering the menu, please make sure the joysticks are in neutral position.

- To calibrate machine speed and tool speed potentiometer, turn them to maximum and minimum positions.
- To calibrate joysticks, move left and right joysticks into maximum position in all 4 directions.

When a joystick have been calibrated it will be indicated on the screen. It is possible to calibrate an individual axis, but to get the best behavior, calibrate all joystick functions and potentiometers before pressing save.

Joystick setup

- OFF - sets thumb switch inactive.
- Auto - if Extra 1 is active, right thumb switch will control it. Otherwise it will have the same function as the top switch. If Extra 2 is active, left thumb switch will control it. Otherwise it will have the same function as the top button.
- Extra 1/Extra 2 - The thumb switch will only control Extra 1/Extra 2. If extra function is deactivated, the thumb switch will be deactivated.
- Tool - (only valid for left joystick) - Thumb switch on left joystick will control the tool function.

MACHINE TYPES

Indicates which machine type the remote control is linked to. This setting must be made when updating the software or replacing the control module etc. Press the selection key to confirm the choice.

MATING BLUETOOTH®-RADIO MODULES

Used for remating the remote control with another machine. During mating, the machine and the remote control must be connected to each other by a cable.

LANGUAGE

Setting for which language should be shown in the display. Press the selection key to confirm the choice.

To return to the factory default language, english. Keep the selection key for Work mode button while turning the main switch until you see the main menu.

UNITS

Setting of units for pressure and temperature that should be shown in the display. Press the selection key to confirm the choice.

TERMINAL DIAGNOSTICS

Test menu for the functions in the terminal (remote control). Joysticks, potentionmeters and pushbutton can be tested.

SYSTEM INFORMATION



This shows the version of the software in the terminal and the two control modules.

MAINTENANCE AND SERVICE

General



WARNING! Most accidents involving machines occur during trouble shooting, service and maintenance as staff have to locate themselves within the machine's risk area. Prevent accidents by being alert and by planning and preparing the work.

If service operations or trouble shooting does not require the machine to be switched on, the power cable must be removed and positioned so that it cannot be connected by mistake.

If servicing operations require the motor to be in operation, be aware of risks when working with or in the vicinity of moving parts.

Perform maintenance and servicing in accordance with this Operator's Manual to avoid shutdowns and to maintain the machine's value.

Maintain the machine's supplementary equipment and tools as well.

The user must only carry out the maintenance and service work described in this manual. More extensive work must be carried out by an authorized service workshop.

Use only original spare parts for repairs.

Measures to take in advance of maintenance, service and trouble shooting

General

- Ensure that the machine is positioned in a safe area.
- Place the machine on a flat surface with the arm system and outriggers down.
- Several components heat up during use of the machine. Do not commence any servicing or maintenance tasks until the machine has cooled down.
- Set out clear signs to inform persons in the vicinity that maintenance work is in progress.
- Ensure that the working area is sufficiently illuminated to create a safe working environment.
- Ascertain the location of fire-extinguishers, medical supplies and emergency telephone.

Protective equipment

- Wear personal protective equipment. See instructions under the heading "Personal protective equipment".

- Use an approved lifting device to secure and lift heavy machine parts. Also ensure that there is equipment to secure machine parts mechanically.

Working environment

- The area around the machine must be free of dirt in order to minimize the risk of slipping.
- Clean the machine. Dirt in the hydraulic system leads rapidly to consequential damage and stoppages.
- Ensure that there is a sufficiently large working area.

Discharge stored energy

- Turn off the motor.
- Put the main switch in the OFF position (O).
- Disconnect the power cable and place it so that it cannot be connected by mistake.

Discharge pressure in the hydraulic system

- Undo the air filter so that the overpressure in the tank is discharged.
- Discharge pressure in the hydraulic cylinders by taking the load off the arm system by resting it on the ground.
- Wait until the pressure has decreased via internal leakage.
- Discharge the pressure in the hydraulic accumulator.
Refer to the directions under "Functional inspection" in the "Maintenance and service" section.

Dismantling

- When dismantling machine parts, heavy components can start moving or fall down. Secure moving parts mechanically before loosening screw joints or hydraulic hoses.
- Pipe and hose couplings can remain pressurized despite the motor being switched off. Always work on the assumption that the hoses are under pressure when dismantling. Take great care when undoing connections and use appropriate personal protective equipment.
- Make sure to mark all cables and hoses that are undone in conjunction with service and maintenance in order to ensure correct reassembly.

After Maintenance and Service

Test running the machine

- The machine's movements can be defective if a terminal, cable or hose is incorrectly mounted. Exercise caution during test runs and be prepared to turn the machine off immediately in the event of a fault.

MAINTENANCE AND SERVICE

Cleaning



CAUTION! Turn off the motor. Disconnect the power cable and place it so that it cannot be connected by mistake.

The area around the machine must be free of dirt in order to minimize the risk of slipping.

Use appropriate personal protective equipment.

When cleaning the machine there is a risk of getting dirt and harmful substances in the eyes, for example.

Dirt and harmful substances can be released from the machine when using high pressure equipment.

High-pressure jetting using water or air can permeate into the skin and cause serious injury. Never aim a high-pressure jet towards the skin.

Cleaning method

The cleaning method varies depending on type of contaminants and how dirty the machine is. A mild degreasing agent can be used. Avoid skin contact.

NOTICE! High-pressure washing and compressed air should be used with extreme caution, incorrect use can damage the machine.

Bear the following in mind when using high-pressure washing:

- High-pressure washing with the wrong nozzle or high pressure can damage electrical components, electric cables and hydraulic hoses.
- The high pressure jet can damage seals and lead to water and dirt permeating into the machine, resulting in serious damage.
- Stickers can be washed away.
- The surface finish can be damaged.

Cleaning of components

There are a number of components that require special consideration when cleaning.

Hydraulic tank

Place a plastic bag over the tank's air filter and seal it with a rubber band to avoid water getting into the tank.

Cooler

Allow the cooler to cool down before cleaning. Use compressed air to clean the air fins. If necessary, use high-pressure washing and degreasing agent. Incorrect use of high-pressure washing or compressed air can

distort the cooler's fins and thereby impair the cooling capacity.

- Max. pressure 100 bar.
- Spray directly towards the cooler, in parallel with the fins.
- Keep a distance of at least 40 cm between the cooler and the nozzle.

Electrical components

Clean electric motor, electric cabinet, terminals and other electrical components with a cloth or with compressed air. Do not spray water at electrical components. Dry the remote control with a damp cloth. Never use high-pressure washing. Blow clean internally using compressed air.

After washing

- Lubricate all the machine's lubrication points.
- Blow electrical terminals dry using compressed air.
- Exercise caution when the machine is started after washing. If any components have been damaged due to moisture, the machine's movements can be defective.

MAINTENANCE AND SERVICE

Service schedule

The service schedule is based on the machine's operating time. More frequent service intervals might be necessary when working in dusty or hot environments and in conjunction with work that generates high temperatures. A description of how the operations are to be performed is to be found in the service review.

	Daily maintenance / After transport	Weekly service	After the first 8 hours	After the first 50 hours	250 hours service	500 hours service	1,000 hours service
Lubrication							
Boom-Stick and Tool Hitch, containing cylinders and shafts	X	X		X	X	X	X
Outriggers, containing cylinders and shafts		X		X	X	X	X
Slewing ring: grease zerks and ring teeth		X		X	X	X	X
Cleaning							
Machine		X					
Cooler		X					
Level check							
Hydraulic oil	X	X		X	X		
Breaker lubrication	X	X		X	X	X	X
Gearbox drive motor oil					X	X	
Check of leakage							
Visible hoses (arm system, outriggers etc)	X	X		X	X	X	X
Cylinders	X	X		X	X	X	X
Valve block		X		X	X	X	X
Cooler		X		X	X	X	X
Slew and drive motor		X		X	X	X	X
Visual check of wear and damage							
Hydraulic cylinder: Barrel, rod and rod wiper	X	X		X	X	X	X
Hydraulic hoses	X	X		X	X	X	X
Power cable and connections	X	X		X	X	X	X
Rubber/steel components: outrigger feet and caterpillar tracks	X	X		X	X	X	X
Slewing system				X	X	X	X
Safety decals				X	X	X	X
Joysticks and remote control				X	X	X	X
Shaft bushings and shims					X	X	X
Visual check of mountings (Re-tighten if necessary)							
Bolts and fasteners	X	X		X	X	X	X
Fasteners outrigger cylinders	X	X					
Fasteners boom system and Tool Hitch	X	X					
Electric motor				X			
Hydraulic cooler and cooling fan				X	X	X	X
Slew motor				X	X	X	X
Slewing ring				X	X	X	X
Electrical cabinet rubber damper				X	X	X	X
Controller modules				X	X	X	X
Electrical cabinet component: mounting plates and screw connections					X	X	X

MAINTENANCE AND SERVICE

Visual check of cracks (welded seams, holes or sharp corners)								
Carriage chassis			X			X	X	X
Boom-stick			X			X	X	X
Outrigger cylinders and shafts			X			X	X	X
Cylinders and shafts of Boom-Stick and Tool Hitch			X			X	X	X
Re-tighten mountings								
Fasteners outrigger cylinders			X	X	X	X	X	X
Fasteners boom system and Tool Hitch			X	X	X	X	X	X
Drive motor sprocket				X				
Outrigger bracket				X				
Electrical cabinet component: mounting plates and screw connections				X				
Function check								
Hydraulic cylinders, slew and drive motor/s (smoothness)	X	X		X	X	X	X	X
Emergency stop machine			X	X	X	X	X	X
Machine stop remote control			X	X	X	X	X	X
Track tension			X					
Machine operates via Bluetooth signal (>10m)				X	X	X	X	X
Machine operates via CAN extension cable				X	X	X	X	X
Warning and work light				X	X	X	X	X
Horn				X	X	X	X	X
Filling pump				X	X	X	X	X
Lubrication pump (breaker/tool)				X	X	X	X	X
Function check hydraulic system								
Hydraulic pump - check for unusual sounds				X	X	X	X	X
System pressure thresholds				X	X	X	X	X
Change								
Gearbox drive motor oil				X				X
Hydraulic oil							X	X
Hydraulic oil filter						X	X	X
Hydraulic air filter						X	X	X
	Daily maintenance / After transport	Weekly service	After the first 8 hours	After the first 50 hours	250 hours service	500 hours service	1,000 hours service	

MAINTENANCE AND SERVICE

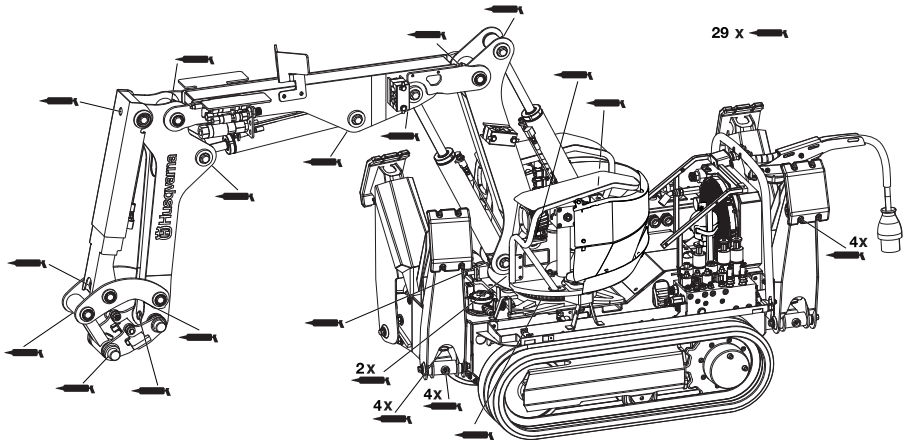

Service review



WARNING! Ensure that nobody starts the machine by mistake. Turn off the motor when the machine has been moved to the desired position. Disconnect the power cable and place it so that it cannot be connected by mistake.

Lubrication

The machine can be moved to a position to access all grease zerks (see picture).

Do as follows:

- Clean the grease zerk. Replace broken or blocked grease zerks.
- Connect the grease gun and pump 2-3 strokes or until grease can be seen at the edges. Use lubricating grease as per the 'Hydraulic fluid and lubrication' table in the 'Technical data' section.

Make a habit of always applying lubrication in the same order in order to more easily remember all lubrication points.

Outriggers and arm system

- Lubricate all joints and cylinder mountings.

Gear ring

On the tower, in front of the arm, you will find an inspection door through which you can lubricate the gear ring. The gears of the gear ring and the two grease zerks of the gear ring's bearing should be lubricated.

To ensure that the grease is evenly distributed it should be applied followed by rotation and then applied again.

- Position the arm so that it points straight ahead in the same direction as the machine. You should now be

able to access the grease zerk through the inspection door.

- Apply the grease gun and lubricate the grease zerk with 2-3 pumps.
- Stand at a safe distance, start the machine, rotate the upper part by 180° and then turn off the motor. You should now be able to access the grease zerk through the inspection door.
- Apply the grease gun and lubricate the grease zerk with 2-3 pumps.

NOTICE! If the instructions are not followed there is a high risk of the gear ring's seals being forced out. The gear ring's bearings are then open to dirt and the seals have to be replaced.

MAINTENANCE AND SERVICE

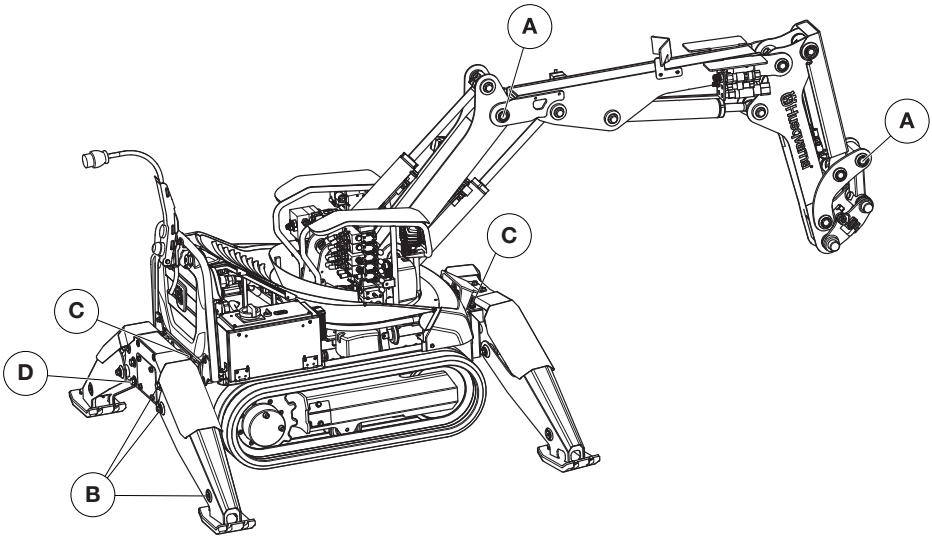

Screw joints

General

Check that all components are properly secured by feeling, pulling etc. Keep a look out for wear damage. This can be caused by components coming loose.

- A screw joint that is secured with adhesive should not be re-tightened. Simply check that it is tight. If the screw joint has come loose, clean the threads before fresh adhesive is applied.
- Check the shafts with respect to mounting/locking. Check expanding shafts by tightening with a torque wrench.
- Locking pins must be checked with respect to damage and mounting.

Shafts

- The design of the expanding shafts ensures that there is not too much play provided that they are tightened regularly. New expanding shafts must be tightened frequently until they have bedded in. Wear damage on the expanding shaft's sleeve is a typical sign that they have not been tightened correctly or sufficiently often.
- If an expanding shaft has slipped out of position it is important that it is centered before being retightened again.

Tightening torque

Use abutment when torquing through shafts to avoid the shaft rotating.

Position		Nm
A	Shafts, arm system	204
B	Shafts, outrigger (M14)	128
C	Support leg bracket (M12)	81
D	Support leg bracket (M16)	197

MAINTENANCE AND SERVICE

Fluid level check

Position the machine on a flat surface. Clean the component before opening for reading or refill in order to prevent dirt entering the system. If the oil level is low, refill with the type and quality as per the 'Hydraulic fluid and lubrication' table in the 'Technical data' section.

Hydraulic fluid

Manoeuvre the machine so the arm system's cylinders are retracted and the outriggers are completely folded.

Check the oil level in the display under "SERVICE" and the tab "OIL REFILL". Refill if the level is below 80%.

Drive motor

Manoeuvre the machine until one of the plugs is level with the middle of the hub and the other one is at the top position.

Unscrew the level plug. The oil level should reach up to the hole.

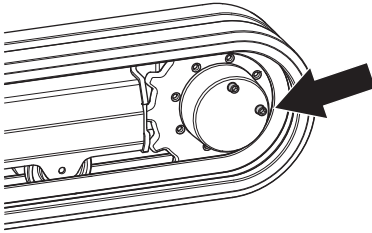

Breaker lubrication

Check that there is grease in the grease cartridge.

Replace the grease cartridge if it is empty.

Wear and damage

NOTICE! Deal with worn components as quickly as possible. There is an increased risk of mechanical breakdown if the machine is used despite damaged or worn components.

Wear of shafts and bushings

Bushings and any shafts necessary must be replaced in the event of play in joints and cylinder mountings. Replace or repair damaged components.

- If there is play in joints the bushings must always be replaced.
- Shafts must be replaced if they have wear damage. If there is wear damage on an expanding sleeve it indicates that it has not been sufficiently tightened.
- Pivot joints must be kept lubricated in order to be able to press out dirt and water that enters and to reduce wear on shafts and bushings.

Wear to rubber components

Check that caterpillar tracks and outrigger feet are intact. If they are so worn that the metal is visible they should be replaced.

Wear to hydraulic hoses

Do not use hoses that are distorted, worn or damaged. Make sure that the cords are not visible. Always have a spare hose on hand. Damaged hoses must be replaced immediately.

- Check that none of the hoses are rubbing against sharp edges. Be alert to the risk of abrasive jets.
- Adjust the length of hydraulic hoses so that they are never entirely stretched.
- Ensure that the hose is not twisted during assembly.
- Avoid severe bends in the hose.

Hydraulic couplings

- Check that the couplings are not damaged. Damaged couplings can damage hoses with the result that they come off. Change damaged couplings immediately.
- The hydraulic couplings should be lubricated before tightening to reduce friction.

Wear to electric cables



WARNING! The power cable must be disconnected when electric cables are checked. Check that the cables' insulating casings are not damaged. Change damaged cables immediately.

Leakage

NOTICE! Leakage can cause serious mechanical breakdowns and an increased risk of slipping. Wash the machine regularly to increase the chance of detecting leakage at an early stage. Deal with leaks as quickly as possible and refill if necessary.

Hydraulic fluid

Leakage of hydraulic fluid leads to an increased risk of dirt getting into the hydraulic system which can lead to breakdowns and mechanical damage. If you detect hydraulic fluid underneath the machine or on the base plate it is probably due to leakage.

Check for leakage at the hose connectors, couplings and cylinders. Leakage can also occur at other hydraulic components and can manifest itself with a strip of dirt.

Cracks

General

A clean machine makes it easier to detect cracks.

The greatest risk of crack formation is:

- At weld seams
- At holes or sharp corners

MAINTENANCE AND SERVICE

Lower part

Check in particular whether cracks have appeared around outrigger mountings both on the lower part and on the outriggers, gear ring mount and weld seams between the machine body and the track sides.

Arm system

Check in particular whether cracks have appeared on the arm system's joints, cylinder mountings and weld seams.

Welding work on the machine

Only qualified welders should carry out welding operations on the machine.



WARNING! Risk of fire. The machine contains flammable liquids and components. Do not undertake any welding in direct connection with flammable liquids, e.g. in the vicinity of tanks, fuel lines or hydraulic pipes. Ensure that there is a fire-extinguisher on site at the workplace.

Risk of inhaling harmful substances. Toxic gases can be formed. When welding indoors, use equipment to extract welding fumes. Never weld in the vicinity of rubber or plastic material. Use a breathing mask.

Components that should not be welded

The following components should not be repaired but replaced:

- Tool attachment
- Cotters
- Cylinders
- Hydraulic tank
- Cast parts

Recommended welding wire

Type	Recommended wire
Flex cored wire	Esab OK 14.03 Tubrod Class: AWS A5.28 E110C-G
Solid	Elgamatic 100 Class: AWS A5.18 ER70S-6
Rod	Esab OK 75.75 Class: AWS A5.5 E11018-G

Functional inspection

General

Functional inspections must ensure that the machine's functions are intact.

Brake functions



WARNING! Exercise great caution during the inspection to ensure that nobody is injured.

Check the drive brake's function by operating the machine on a slope. Release the joysticks. The machine should then break and remain stationary.

Check the slew brake's function by rotating the arm with the machine on a slope. Release the joysticks. The arm should then be braked and stop gently.

Cooler

Overheating has a negative effect on the service life of the machine's components. Clean the cooler when necessary. Refer to "Cleaning the machine" in the "Maintenance and service" section.

Cylinders

Checking cylinder tubes and piston rods must be done with the cylinders extended to the end position. Replace damaged components immediately.

Check that the cylinder tubes are not dented or cracked.

Check that the piston rods are undamaged and straight. A damaged piston rod causes contamination in the hydraulic system, resulting in mechanical damage.

Check the scraper

Tool attachment



WARNING! The tool attachment's cotter and pin are important safety components. A worn or damaged cotter must be replaced with an original spare part, manufacturing your own cotters is not permitted.

Check that the tool attachment is complete and that all parts are intact and correctly mounted.

Hydraulic track tension

Automatic track tensioning can be done in two different ways.

- 1 In the service menu under the tab "Track tension" the tracks can be tensioned automatically. Hold the selection key down to activate the track tension.
- 2 The caterpillar tracks are tensioned automatically when the outriggers are up. Operate the outriggers up and then down. Wait 15 minutes and then check.

Should demolition material or suchlike enter into the side of the tracks during operation, their spring function should prevent breakdowns and stoppages. The spring function consists of a hydraulic accumulator.

- If the tracks become slack it can be due to one of the track tensioning function's non-return valves being blocked or broken.
- If the belts do not spring, the hydraulic accumulator may be defective.

MAINTENANCE AND SERVICE

Checking automatic track tension

Correct track tensioning is important for the service life of the track and the track tensioning.

- Extend the outriggers. Let the machine rest on its outriggers.
- Remove the left side cover.
- Release the counter lock knob (1).

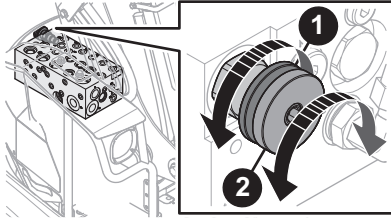

- Release the pressure by turning the release knob to the end position (2).
- Slide the tensioning wheel towards the center.
- Close the valve by turning it back into position (2).
- Lock the counter lock knob by turning it back into position (1).
- Refit the left side cover.

Cleaning non-return valves

The non-return valves can be cleaned by discharging the pressure in the accumulator and thus loosening the tension of the tracks.

- Remove the left side cover.
- Release the counter lock knob (1).

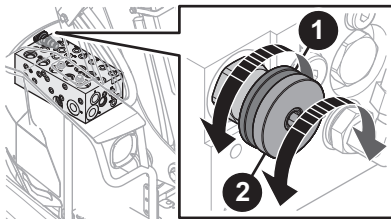

- Release the pressure by turning the release knob to the end position (2).
- Operate the outriggers up and down. Hydraulic fluid is then pumped around and cleans the non-return valve.
- Close the valve by turning it back into position (2).
- Lock the counter lock knob by turning it back into position (1).
- Operate the outriggers up and down to tension the track.
- Refit the left side cover.

Breaker lubrication



CAUTION! Exercise great caution during the inspection to ensure that nobody is injured.

Make sure grease is reaching the breaker by detaching the lubrication hose from the breaker. Uncouple the tool hoses. Start the machine and activate the breaker function.

Tools

Check that the tool can be used in such a way that neither the operator nor people in the vicinity are exposed to unnecessary risks. Refer to the Operator's Manual of the tool for other checks.

Change

General



CAUTION! Chemicals such as degreasing agent, grease and hydraulic fluid can give rise to allergies in conjunction with repeated skin contact. Avoid contact with the skin, use protective equipment. Changing liquids and filters must be done in such a way that the machine's hydraulic system and the surrounding environment are not damaged. Dispose of residual products according to local laws.

Position the machine on a flat surface. Discharge the machine and allow it to cool. Clean the component before opening it for refilling in order to prevent dirt getting in. If the level is low, fill in accordance with the following instructions.

Hydraulic fluid



CAUTION! Allow the machine to cool. Hot oil can cause severe burn injuries.

General

The type of hydraulic oil delivered with the machine is stated on the decal at the next to the filling pump.

Refer also to "Technical data" for choice of suitable hydraulic oils.

NOTICE! The machine can be damaged if different types of hydraulic fluid are mixed. Check which quality of hydraulic fluid the machine's hydraulic system contains before refilling or changing. Do not use hydraulic fluid that is not recommended.

MAINTENANCE AND SERVICE

Draining hydraulic fluid

- Maneuver the machine so the arm system's cylinders are retracted and the outriggers are completely folded.
- Undo the air filter so that the overpressure in the tank is discharged.

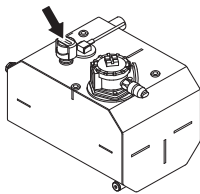

- Place a collecting vessel under the tank's drain plug and open the plug.

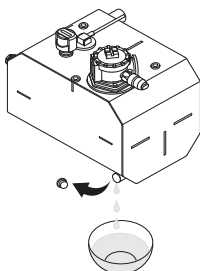

- Screw on the drain plug when all the liquid has drained out.
- Changing oil filters. Refer to "Oil filter" in the "Maintenance and service" section.
- Tighten the air filter.

NOTICE! Do not start the motor when the hydraulic tank is empty, the hydraulic pump will be damaged.

Refill hydraulic fluid

The machine is equipped with a refill pump.

- Maneuver the machine so the arm system's cylinders are retracted and the outriggers are completely folded.
- Clean the refill pump's suction hose. Remove the plug and put the hose into the fluid container.
- Check the oil level in the display under "SERVICE" and the tab "OIL REFILL".
- Hold the selection key down to refill oil. The pump will shut off automatically when the tank is full. See instructions in the section "Settings".
- Start the machine and operate the cylinders between outer and inner end position a number of times to remove air that might have entered the hydraulic system while refilling.

Oil filter



CAUTION! Allow the machine to cool. Hot oil can cause severe burn injuries.

- Undo the air filter so that the overpressure in the tank is discharged.
- Thoroughly clean the outside of the filter and the surrounding parts.
- Remove the filter cover. Lift up the sealing ring, the spring and the filter holder together with the filter cartridge.

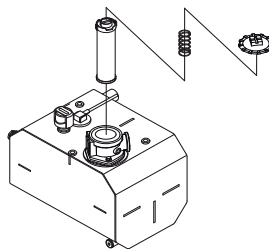

- Remove the filter cartridge from the filter holder.
- Check whether there is an unusually large amount of large metal particles or sealing compound in the filter holder. If this is the case the machine's hydraulic system must be checked for faults.
- Clean the filter holder with degreasing agent. Rinse with warm water and blow dry using compressed air.
- Install the new filter in the filter holder and put it in the tank. Install a new sealing ring.
- Install the spring and the filter cover.

Air filter

- Thoroughly clean the outside of the filter and the surrounding parts.
- Replace the filter.

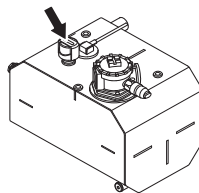

TROUBLESHOOTING

Error messages

There are two types of error messages that can appear on the display:

- Service messages - These messages do not represent any direct danger for the operator or the machine.
- Warnings - These warn of faults or safety defects that can cause mechanical damage.

All acknowledged fault messages remain as small yellow or red warning triangles in the service field and can be accessed by going to the service menu and selecting "Warnings". The messages are listed in order of priority, highest priority first.

When a fault that has in some way restricted the machine's functions ceases, a message appears on the display. This message must be acknowledged for the machine to return to full functionality.

TROUBLESHOOTING

Service messages

Message on the display	Indication on the machine	Cause	Possible action
Oil filter need to be changed		The oil filter must be replaced.	Replace the oil filter.
Low hydraulic oil level	Flashes 3 times with the work lighting.	Oil level is low.	Refill more oil.
Low battery		Low battery level in terminal.	Change battery or connect orange cable.
Left joystick button on left joystick activated during power up. Button has been disabled.	No indication on machine.	Joystick activated during terminal start up.	Check joystick value in test menu (terminal diagnostics). Restart terminal.
Right joystick button on left joystick activated during power up. Button has been disabled.			
Left joystick button on right joystick activated during power up. Button has been disabled.			
Right joystick button on right joystick activated during power up. Button has been disabled.			
Up/Down movement on left joystick activated during power up. Up/Down movement has been disabled.			
Left/Right movement on left joystick activated during power up. Left/Right movement has been disabled.			
Up/Down movement on right joystick activated during power up. Up/Down movement has been disabled.			
Left/Right movement on right joystick activated during power up. Left/Right movement has been disabled.			
Thumb switch on right joystick activated during power up. Thumb switch has been disabled.			
Thumb switch on left joystick activated during power up. Thumb switch has been disabled.			
Thumb switch on Left joystick Error. Thumb switch has been disabled.			
Up/Down movement on Left joystick Error. Up/Down movement has been disabled.			
Left/Right movement on Left joystick Error. Left/Right movement has been disabled.			
Thumb switch on Right joystick Error. Thumb switch has been disabled.			
Up/Down movement on Right joystick Error. Up/Down movement has been disabled.			
Left/Right movement on Right joystick Error. Left/Right movement has been disabled.			
Connection to terminal radio failed. Please check battery level and restart terminal.		The terminal can not communicate with the terminal radio	Change battery, check cables to terminal radio.
Cable connection established between terminal and machine but no control modules found. Please check cable and control modules.		The terminal can connect to the machine but not to PLC modules.	Check fuses to the PLC moduels, check supply and CAN cables to the modules.
Radio connection established between remote control and machine but no control modules found. Please check control modules and CAN connection in machine.		The terminal can connect to radio in machine but not to PLC modules.	

TROUBLESHOOTING

Warning messages

Message on the display	Indication on the machine	Effect on machine functions	Cause	Possible action	
Oil temperature too high. Machine speed has been reduced and tool is disabled.	Flashes with the work lighting and puts the machine in circular pumping mode. The motor is shut down if the message is not acknowledged within 10 sec.	The machine deactivates the tool and reduces the machine speed with 50%.	The oil temperature is above 90°C	Put the machine into circular pumping mode to cool the hydraulic oil.	
Oil temperature too low. Machine speed has been reduced and tool is disabled.				Clean the cooler	
				Clean the cooler fan	
Oil pressure is above allowed limits. Please check proportional pressure relief valve.			The oil temperature is below -5°C	Warm up the lower section by running the caterpillar tracks, first slowly and then more quickly with the outriggers extended.	
Overloading when soft starting. Check the input voltage and soft start settings.				Check the sensor and cables to the sensor.	
Phase error. Please check: Incoming phases Incoming voltages Machine speed has been reduced and tool is disabled.			Oil pressure exceeds allowed pressure limit.	Check proportional pressure relief valve.	
Motor temperature too high. Machine speed has been reduced and tool is disabled.			Overload protection alarm in soft starter.	Verify pressure regulator by running a cylinder to end position for 2 seconds.	
No hydraulic pressure detected. Please check: Oil level Motor rotation			Flash with the work lighting.	Check the input voltage and the soft starter settings.	
Check Emergency Stop on machine and safety relay function.				Phase error in incoming 3 phase and the motor temperature is too high.	Check the voltage level of the incoming phases, or if a phase has been lost.
Terminal lost for more than 120 seconds			Prevents starting of the machine.	High motor temperature detected	Allow the circulation pump to run and wait for the temperature to drop.
Oil pressure in circulation pump mode too high. Please check circulation valve		Warns if the pressure sinks below 2 bar when the motor is running.	Check if the pump produces pressure. Check hydraulic fluid level		
Motor start error, please check: Soft starter Contactors Start relay		Emergency stop pressed on the machine, faulty safety relay or safety relay control circuit open.	Check if the motor runs in the correct direction.		
		The machine has not been in contact with the remote control for 2 min.	Check the emergency stop on the machine. Check safety relay and its safety circuit		
		The oil pressure in circulation pumping is too high.	Check start relay		
		No bypass signal from soft starter	The machine flashes 3 times when the message is acknowledged.		
			Check the circulation valve (idle valve).		
			Check bypass signal from soft starter.		
			Check soft starter, contactors, fuse F6 and start relay.		

TROUBLESHOOTING

Communication error

Message on the display	Indication on the machine	Effect on machine functions	Cause	Possible action
No secondary control module found in machine. Please check control modules and CAN connection in machine.	No indication on machine.		The PLC module do not find any slave module to communicate with.	Restart the machine. Check supply and CAN cables to the slave module.
Machine type not selected. Enter machine type menu and select machine type for the current machine			Communication problem between master module and terminal.	Restart the machine and the terminal.
Selected machine type not supported by terminal. This may affect machine type specific functions				
Communication error. Machine type could not be uploaded to terminal. Please restart terminal.				
Communication error. List of available machine types could not be uploaded to terminal. Please try again				
Communication error. Machine type may not have been selected correctly in machine. Machine type disabled in terminal. Please make selection again.				
Communication error. No new machine type has been downloaded to machine. Please make machine type selection again.				
Communication error. Parameter could not be updated from machine. Please try again.				
Communication error. Parameter may not have been correctly downloaded to machine. Please try changing parameter again.				
Communication error. Warning information could not be uploaded from machine.				
Communication error. Conflicting warning information. Please restart machine.				
Communication error. Terminal incapable of uploading warning information. Please restart terminal and machine.				
Incompatible software between terminal and machine. Please update software. Machine speed has been reduced and tool is disabled. Use machine with caution.				

TROUBLESHOOTING

Cable/Sensor error

Message on the display	Indication on the machine	Effect on machine functions	Cause	Possible action
Cable to * has faulty circuit. Please check cable.	No indication on machine.	The function using the cable disabled.	The cable has a short circuit or broken circuit.	Check cable.
Cable to * has feedback current without control current. Please check cable.			The cable * have feedback current without being active.	
All warnings associated with ** are disabled. Use machine with caution		All supervision using the sensor is disabled.	Sensor ** is faulty.	Check the sensor * and cables to the sensor.

*Cable error

Cylinder 1, valve
Cylinder 2, valve
Cylinder 3, valve
Cylinder 4, valve
Cylinder 5, valve
Outrigger proportional, valve
Left caterpillar track, valve
Right caterpillar track, valve
Rotation, valve
Tool, valve
Extra function 1, valve
Extra function 2, valve
Front left outrigger, valve
Front right outrigger, valve
Rear left outrigger, valve
Rear right outrigger, valve
Pressure, valve

**Sensor error

Temperature sensor
Pressure sensor
Oil level sensor

TROUBLESHOOTING

Troubleshooting schedule



WARNING! Most accidents involving machines occur during trouble shooting, service and maintenance as staff have to locate themselves within the machine's risk area. Prevent accidents by being alert and by planning and preparing the work. You can also refer to 'Preparations for maintenance and service' in the 'Maintenance and service' section.

If service operations or trouble shooting does not require the machine to be switched on, the power cable must be removed and positioned so that it cannot be connected by mistake.

Following the trouble shooting guide will provide you with tips to facilitate the trouble shooting process. You can also perform simpler trouble shooting operations. The operator may only carry out the maintenance and service operations that are described in this Operator's Manual. More extensive interventions must be carried out by an authorized service workshop.

Always start by checking any error messages on the remote control. Follow the instructions for the respective message in accordance with the error messages section.

Problem	Cause	Possible action
The electric motor does not start.	Emergency stop/machine stop is pressed.	Check that the emergency stop or machine stop button are not pressed by turning them clockwise.
	Too low mains voltage to the machine.	Check power supply and ensure correct voltage.
	A fuse has blown.	Check that the mains voltage is compatible with the machine and that the correct fuses are used.
	No radio communication between remote control and machine.	Green symbol in the display indicates contact. If the symbol is red, check that the battery for the remote control is charged and correctly installed. Ensure that the correct remote control is used. Check that the communication cable and antenna cable on the machine are properly secured. Test run the machine using cable control.
Fuses for the mains connection blow when starting.	The machine's fuses have too low a rating.	Check that the mains voltage is compatible with the machine and that the correct fuses are used.
	Electric motor blown.	Contact your service agent
	The hydraulic pump has cut out.	Contact your service agent
The motor runs but the hydraulic functions have no power or do not work at all.	Too little hydraulic fluid in the tank. (Noise emanating from the pump.)	Stop the motor at once. Investigate and rectify any leaks there might be. Refill hydraulic fluid.
	Circulation valve open.	Check the diode on the valve cap at the bottom of valve block 1. If the circulation valve is open the diode does not light up. Check the cable to the control module.
	Fault in the pump regulator.	Extend an unloaded cylinder to its end position and check the pump pressure in the display. If you get maximum pressure the pump regulator is OK.
	Standby pressure set too low.	Activate the remote control without operating any functions and check the settings for stand-by pressure on the display. The pressure should be 20 ± 1 bar.
Arm movements and tool function run slowly.	The potentiometer that controls mechanical movements/tools is screwed down. The potentiometer that controls mechanical movements/tools is turned down.	Turn up the potentiometer(s) from slow to fast.
	Standby pressure set too low.	Activate the remote control without operating any functions and check the settings for stand-by pressure on the display. The pressure should be 20 ± 1 bar.

TROUBLESHOOTING

An individual function is running slowly.	Internal leakage in the cylinder.	Extend the cylinder to end position without any load and check the pump pressure on the display. The sealing in the cylinder is OK if maximum pressure is obtained.
	Restriction in a hydraulic hose.	Run an unloaded cylinder. Check the pump pressure on the display. If you receive max. pressure but not full speed on the cylinder, this indicates a strangulation in the hydraulic hose.
	Fault in the pilot control valve.	Contact your service agent
An individual function is not working.	Joystick in an operative position when starting the remote control.	Restart the remote control with the joystick in neutral position.
	Fault in the pilot control valve or the spool in the valve is stuck or damaged.	Contact your service agent
The machine sinks on the outriggers.	Leaking check valves in outrigger cylinders.	Contact your service agent
Jerky arm movements.	The hydraulic fluid has been heated up in a cold machine.	Warm up the machine.
	A slide valve is seizing due to contamination.	Contact your service agent
	Air in the pilot control valve.	Contact your service agent
	Broken O-rings in the pilot control valves.	Contact your service agent
	Fault in the pilot pressure circuit.	Contact your service agent
Cylinder sinks*.	Contamination in the hydraulic system.	Investigate any leaks there might be. Change hydraulic fluid and filter.
	Leakage in the cylinder.	Locate the leak and replace any components that might be damaged.
	Defective valve.	Contact your service agent
	Faulty counter balance valve.	Contact your service agent
Overheating in the hydraulic system.	Cooler blocked or obstructed.	Clean the cooler
	Too high ambient temperature.	Use forced cooling.
	Maximum pressure or standby pressure set too high in the pump.	Contact your service agent
	Defective hose or coupling.	Replace faulty component.
	Restriction in main pipe or pipe to tool.	Replace faulty component.
	Power extraction too high due to faulty or unsuitable tool.	Check that the tool's pressure and flow are compatible with the machine's specification.
	Defective hydraulic pump.	Contact your service agent
	Knocking noise in the hydraulic system.	Not enough hydraulic fluid in the tank.
Air in the hydraulic fluid.		Run the machine without a load until air and fluid have separated.
Defective hydraulic pump.		Contact your service agent
Discolored hydraulic fluid.	Cloudy grey fluid indicates water in the system.	Investigate and rectify the cause of water entering. Change hydraulic fluid and filter.
	Black fluid indicates carbon formation due to too high operating temperature.	Investigate and rectify the cause of overheating. Change hydraulic fluid and filter.

* If cylinder 3 and 4 slowly sink (approx. 1 cm/min) this is entirely normal as they do not have any counter balance valves.

TECHNICAL DATA

Guide values for mains connection

The power cable must be dimensioned by a qualified person in accordance with national and local regulations. The mains socket to which the machine is connected must be dimensioned for the same amperage as the machine's electrical socket and extension cable, e.g. a 63 A electrical socket must be preceded by a 63 A fuse.

Motor - 15 kW

Nominal voltage from power source	Min. voltage at machine	Cable area	Starting current		Motor output	Setting thermal overload relay	Max. cable length*
V	V	AWG/mm ²	A		kW	A	m
400	380	4	75	50 Hz	15,0	27,0	177
400	380	6	75		15,0	27,0	266
400	380	10	75		15,0	27,0	444
460	440	4	75	60 Hz	15,0	24,0	200
460	440	6	75		15,0	24,0	300
460	440	10	75		15,0	24,0	500

*The cable length is calculated with respect to a voltage drop of 20 V during operation. Type of power source and wiring from power source to power outlet affects possible cable length.

The hydraulic system pressure

Type of pressure		Pressure, bar
Pump pressure	Tool, max	3626/250
	Rotating function	2611/180
	Outrigger down/up	3626/1885 / 250/130
	Arm functions	2901/200
	External hand tool	725-3626/50-250 (default 2030/140)
Standby pressure*		20+/-1

* The pressure that the pump delivers when no function is activated and the circulation valve is shut.

Hydraulic fluid and lubricant

Hydraulic fluid

Quality	Minimum starting temperature, °F/°C	Max. temperature, °F/°C	Ideal working temperature, °F/°C
Mineral oil ISO VG32	-4/-20	167/75	95-140/35-60
Mineral oil ISO VG46 (Standard)	14/-10	185/85	45-70/13-158
Mineral oil ISO VG68	23/-5	194/90	131-176/55-80

Always ask the machine manufacturer before using a type of hydraulic fluid other than those mentioned above.

The quality of hydraulic fluid that the machine was supplied with is indicated on the sticker next to the filling pump.

NOTICE! The machine can be damaged if different types of hydraulic fluid are mixed. Check which quality of hydraulic fluid the hydraulic system contains before refilling or changing.

TECHNICAL DATA

Lubricant

Component	Quality	Standard
Oil gearbox drive motor	SAE 80W-90	API GL 5
All lubrication points with grease zerks	NLGI 2	

Preset limit values

Description	Temperature, °F/°C
Oil temperature too high.	194/90
Oil temperature too low.	23/-5

Technical data

General	
Rotation speed, rpm	6
Transport speed max., km/h / mph	1,9/3
Angle of inclination, max.	30°
Hydraulic system	
Volume hydraulic system, l/gal	40/10
Pump type	Load sensing axial piston pump with variable displacement
Pump flow max.*, l/min / gal/min	52/14
Electric motor 15 kW	
Power, kW	15 (50 Hz)
	15 (60 Hz)
Speed, rpm	2920 (50 Hz)
	3520 (60 Hz)
Voltage, V	380-420 (50 Hz)
	440-480 (60 Hz)
Current, A	27 (50 Hz)
	24,3 (60 Hz)
Control system	
Control type	Remote control
Signal transmission	Bluetooth/cable
Frequency band, GHz	5.3/2,4
Maximum radio frequency power transmitted, dBm	13
Weight	
Without tool, lb / kg	985/2172
Tools	
Rec. max. weight, lb / kg	200/441

*Maximum pump flow and system pressure cannot be taken out at the same time, the motor will be overloaded. 60 Hz has limited displacement.

TECHNICAL DATA

Dust reduction data

Water supply recommendation (tap or external pump))

Type		Tool					
		Hydraulic breaker			Concrete crusher		Drum cutter
		SB152	SB202	SB302	DCR100	DCR300	ER50
Recommended Water Pressure, bar / PSI		4.0 / 58.0			2.0 / 29.0		2.0 / 29.0
Water consumption at 4 bar / 58 PSI, l/min / gpm		=< 5.0 / =< 1.3	=< 9.0 / =< 2.4		6.5 / 1.7		7.9 / 2.1
Minimum requirements	Water pressure, bar / PSI	3.0 / 43.5			1.0 / 14.5		1.5 / 21.8
	Water consumption, l/min / gpm	5.0 / 1.3			3.0 / 0.8		4.1 / 1.1

TECHNICAL DATA

Reach and transport diagram

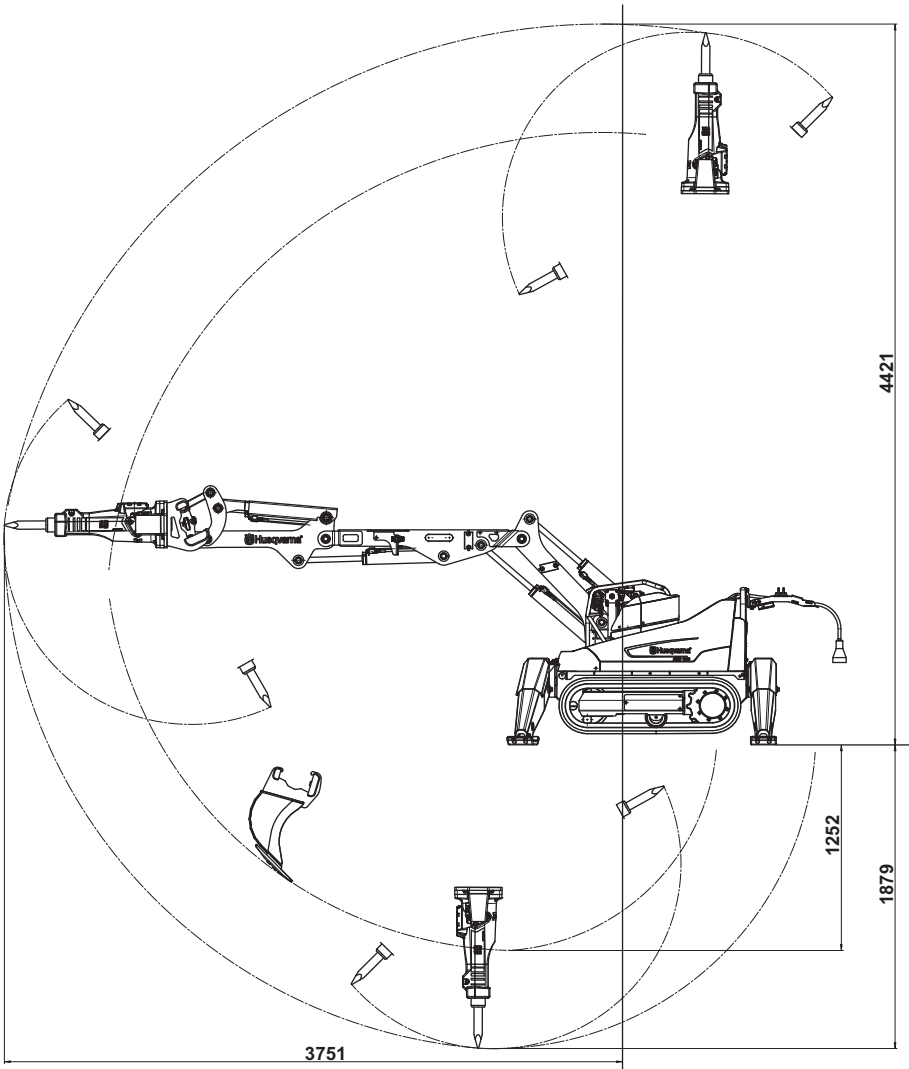

TECHNICAL DATA

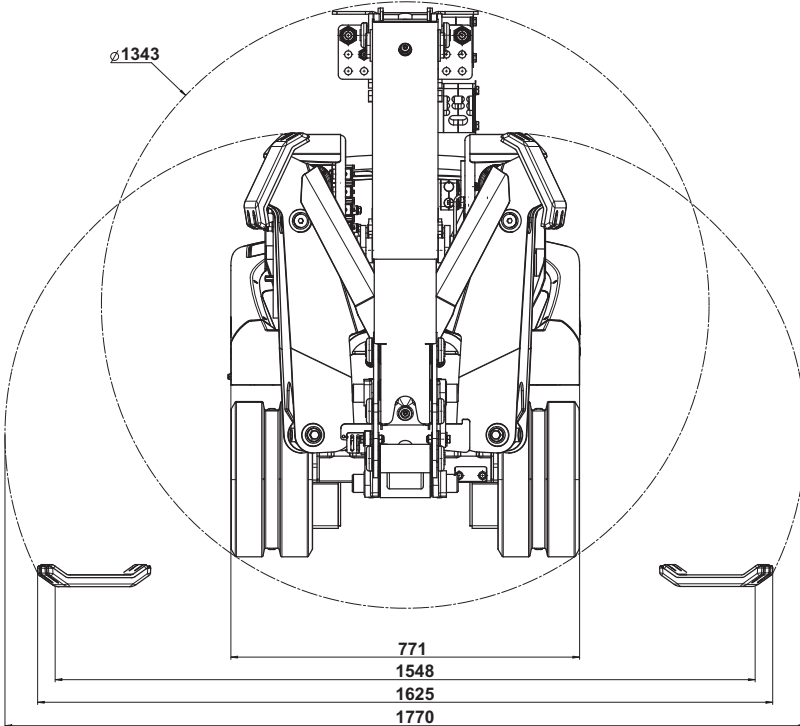
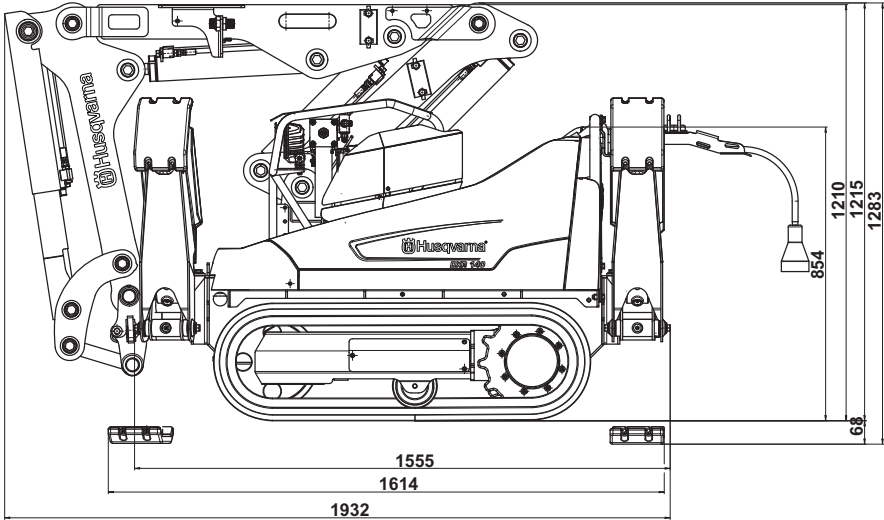

US WARRANTY STATEMENT

WARRANTY POLICY

All warranty claims will be determined after inspection at a designated facility. A Returned Goods Authorization is required for all warranty claims. Contact Husqvarna Customer Service Department at 800-845-1312 for an RGA. The customer must prepay the freight and absorb any labor expense required to return or replace a product submitted for warranty consideration. Husqvarna will pay return shipping expenses for repaired or approved replacement products.

EQUIPMENT

Equipment manufactured by Husqvarna is warranted to be free from manufacturing defects in normal service for a period of two (2) years from date of purchase by the original consumer purchaser. **Component manufacturers offer separate warranty periods. Call Technical Services at 800-288-5040 for complete information.**

Our obligation under this warranty is expressly limited to the replacement or repair at Husqvarna Construction Products North America, Olathe, Kansas 66061, or at a service facility designated by us, of such part or parts as inspection shall disclose to have been defective.

This warranty does not apply to defects caused by damage, unreasonable use, faulty repairs made by others than an approved Husqvarna servicing dealer, or defects caused by failure to provide reasonable maintenance, while in the possession of the consumer. Further, the warranty is void if the product, or any of its components, are altered or modified by the consumer purchaser, or if the product is used in an inappropriate manner or with tools not recommended by the manufacturer.

Exceptions: Drill motors - 3 months, Wall saws - 1 year, Power cutters - 3 months, DM230 - 1 year, DM225 - 3 months, Gyro systems - 1 year, CD40 system - 1 year, DS160 C - 1 year, Smart box - 1 year, CS2515 - 1 year, PP455 E - 1 year, PP345 E - 1 year, HP40 - 1 year.

Wear items: Filters, spark plugs, bearings*, belts, wheels** and wear pads.

*Except IntelliSeal™ system. **Except delamination.



www.husqvarnacp.com
US - Original instructions

1140548-27



2018-11-27