



Husqvarna[®]



315iC

Contents

Introduction.....	2	Troubleshooting.....	22
Safety.....	4	Transportation, storage and disposal.....	23
Assembly.....	17	Technical data.....	25
Operation.....	18	Accessories.....	26
Maintenance.....	21	EC Declaration of Conformity.....	27

Introduction

Product description

We have a policy of continuous product development and therefore reserve the right to modify the design and appearance of the products without prior notice.

Note: National regulations can set limit to the operation of the product.

Intended use

The product is used with a trimmer head to cut grass. Do not use the product for other tasks than grass trimming and grass clearing.

Product overview

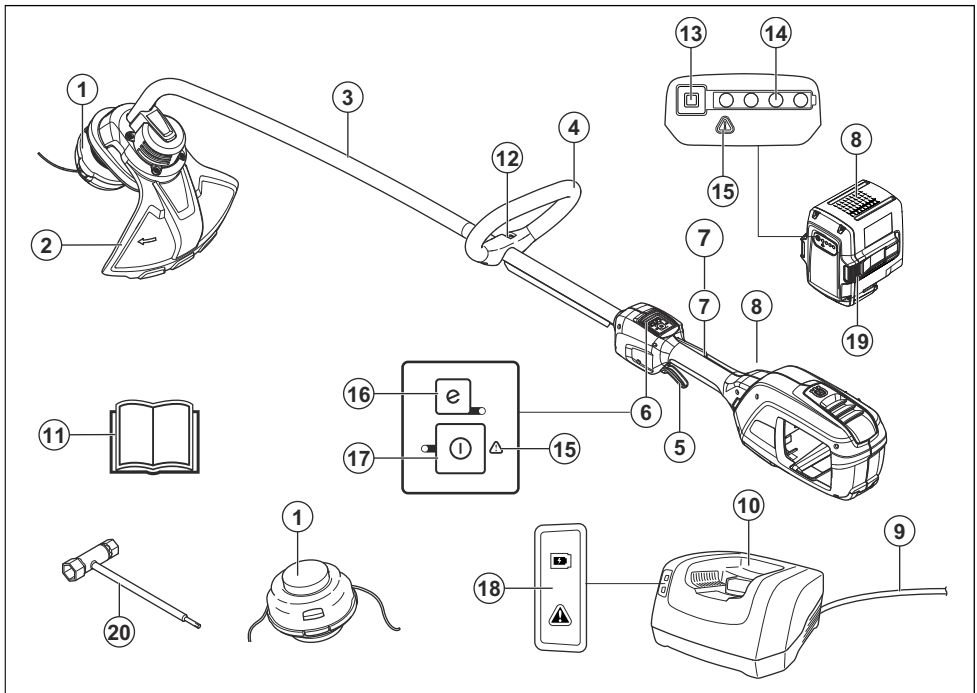

- | | |
|-----------------------------|----------------|
| 1. Trimmer head | 3. Shaft |
| 2. Cutting attachment guard | 4. Loop handle |

5. Power trigger
6. Keypad
7. Power trigger lockout
8. Battery (Accessory)
9. Cord (Accessory)
10. Battery charger (Accessory)
11. Operator's manual
12. Handle adjustment
13. Battery indicator button
14. Battery status
15. Warning indicator
16. SavE button
17. Start/stop button
18. Power on and warning indicator
19. Battery release buttons
20. Socket wrench

electronic equipment. (Applies to Europe only)



Watch out for thrown objects and ricochets.



Use flexible cutting wire as trimmer line. Do not use metal cutting elements.



The arrows show the limit for the handle position.

Symbols on the product



WARNING! This product is dangerous. Injury or death can occur to the operator or bystanders if the product is not used carefully and correctly. It is very important that you read and understand the contents of the operator's manual. Please read the operator's manual carefully and make sure that you understand the instructions before use.



Use the approved eye protection.



Maximum speed of the output shaft.



The product agrees with the applicable EC directives.



The operator of the attachment must ensure, while working, that no persons or animals come closer than 15 meters.



Use approved protective gloves.



Use heavy-duty slip-resistant boots.



The product or package cannot be disposed as domestic waste. The product and package must be sent to a correct recycling station for the recovery of electrical and

Direct current.



Noise emission to the environment refer to the European Community's Directive. The emission of the product is specified in the Technical data chapter and on the label.

yyyywwxxxx

The rating plate shows the serial number. **yyyy** is the production year, **ww** is the production week and **xxxx** is the sequential number.

Symbols on the battery and/or on the battery charger



Recycle this product at a recycling station for electrical and electronic equipment. (Applies to Europe only)



Fail-safe transformer.



Use and keep the battery charger indoors only.



Double insulation.

Product liability

As referred to in the product liability laws, we are not liable for damages that our product causes if:

- the product is incorrectly repaired.
- the product is repaired with parts that are not from the manufacturer or not approved by the manufacturer.

- the product has an accessory that is not from the manufacturer or not approved by the manufacturer.
- the product is not repaired at an approved service center or by an approved authority.

Safety

Safety definitions

Warnings, cautions and notes are used to point out specially important parts of the manual.



WARNING: Used if there is a risk of injury or death for the operator or bystanders if the instructions in the manual are not obeyed.



CAUTION: Used if there is a risk of damage to the product, other materials or the adjacent area if the instructions in the manual are not obeyed.

Note: Used to give more information that is necessary in a given situation.

General power tool safety warnings



WARNING: Read all safety warnings and all instructions. Failure to follow the warnings and

instructions may result in electric shock, fire and/or serious injury.

Note: Save all warnings and instructions for future reference. The term "power tool" in the warnings refers to your mains-operated (corded) power tool or battery-operated (cordless) power tool.

Check before starting

- Always remove the battery to prevent the product being started by accident. Always remove the battery before any maintenance on the product.
- Before using the product and after any impact, check for signs of wear or damage and repair as necessary.
- Inspect the working area. Remove all loose objects, such as stones, broken glass, nails, steel wire, string etc. that could be thrown out or become wrapped around the cutter or cutter guard.
- Check the motor for dirt and cracks. Clean off grass and

leaves from the engine using a brush. Gloves should be worn when necessary.

- Check that the trimmer head is completely attached to the trimmer.
- Check that the product is in perfect working order. Check that all nuts and screws are tight.
- Check that the trimmer head and trimmer guard are not damaged or cracked. Replace the trimmer head or trimmer guard if they have been exposed to impact or are cracked. Always use the recommended guard for the cutting attachment you are using. See chapter on Technical data.
- The product operator must ensure that no people or animals come closer than 15 meters while working. When several operators are working in the same area the safety distance should be at least 15 meters.
- Carry out an overall inspection of the product before use. See the maintenance schedule.
- National or local regulations may regulate the use. Comply to given regulations.

Work area safety

- **Keep work area clean and well lit.** Cluttered or dark areas invite accidents.
- **Do not operate power tools in explosive atmospheres, such as in the presence of flammable liquids, gases or dust.** Power tools create sparks which may ignite the dust or fumes.
- **Keep children and bystanders away while operating a power tool.** Distractions can cause you to lose control.

Electrical safety

- **Avoid body contact with earthed or grounded surfaces, such as pipes, radiators, ranges and refrigerators.** There is an increased risk of electric shock if your body is earthed or grounded.
- **Do not expose power tools to rain or wet conditions.** Water entering a power tool will increase the risk of electric shock.
- **Do not abuse the cord. Never use the cord for carrying, pulling or unplugging the power tool. Keep cord away from heat, oil, sharp edges or moving**

- parts.** Damaged or entangled cords increase the risk of electric shock.
- **When operating a power tool outdoors, use an extension cord suitable for outdoor use.** Use of a cord suitable for outdoor use reduces the risk of electric shock.
- **If operating a power tool in a damp location is unavoidable, use a ground fault circuit interrupter (GFCI) protected supply.** Use of a GFCI reduces the risk of electric shock.
- This appliance is not intended for use by person (including children) with reduced physical, sensory or mental capabilities, or lack of experience and knowledge, unless they have been given supervision or instruction concerning use of the appliance by a person responsible for their safety. Children should be supervised to ensure that they do not play with the appliance.
- Never allow children or other persons not trained in the use of the product and/or the battery to use or service it. Local laws may regulate the age of the user.

Personal safety

- The cutting tool does not stop immediately after the product is turned off.
- The product is only designed for trimming.
- Keep bystanders away.
- **Stay alert, watch what you are doing and use common sense when operating a power tool. Do not use a power tool while you are tired or under the influence of drugs, alcohol or medication.** A moment of inattention while operating power tools may result in serious personal injury.
- Store the equipment in a lockable area so that it is out of reach of children and unauthorized persons.
- Keep hands and feet away from the cutting area at all times and especially when switching on the motor.
- **Dress properly. Do not wear loose clothing or jewelry. Keep your hair, clothing and gloves away from moving parts.** Loose clothes, jewelry or long hair can be caught in moving parts.
- Wear personal protective equipment. See instructions

under the "Personal protective equipment" heading.

- Always use face or dust mask if operation is dusty.
- Turn off the product when it has to be moved. Always remove the battery when passing the machine to another person.
- Keep in mind that it is you, the operator that is responsible for not exposing people or their property to accidents or hazards.
- The transport guard must always be used for storage and transport.

Power tool use and care

- The only accessories you can operate with this product are the cutting attachments we recommend in the technical data chapter.
- Never use a product that has been modified in any way from its original specification. Never use the product near explosive or flammable materials.
- Never use a product that is faulty. Carry out the safety checks, maintenance and service instructions described in this manual. Some maintenance and service

measures must be carried out by trained and qualified specialists. See instructions under the Maintenance heading.

- Only use original spare parts.
- Always ensure that ventilation openings are kept clear of debris.
- Keep handles dry, clean and free from oil and grease.
- All covers, guards and handles must be fitted before starting.
- Only use the machine in daylight or in other well-lit conditions.
- Do not overreach. Keep proper footing and balance at all times.
- Don't force the product. It will do the job better and with less likelihood of injury at the rate for which it was designed.
- Working in bad weather is tiring and often brings added risk. It is not recommended to use the product in very bad weather, for instance, in dense fog, in heavy rain, strong winds, intense cold, risk of lightning.
- If the product starts vibrating abnormally, stop the product and remove the battery.

- Avoid Unintentional Starting – Don't carry appliance with finger on switch.
- Store Idle Appliances Indoors – When not in use, appliances should be stored indoors
- Walk, never run.

Always use common sense

It is not possible to cover every conceivable situation you can face. Always exercise care and use your common sense. Avoid all situations which you consider to be beyond your capability. If you still feel uncertain about operating procedures after reading these instructions, you should consult an expert before continuing.



WARNING: Never allow children to use or be in the vicinity of the machine. Since the machine is easy to start, children may be able to start it if they are not kept under full surveillance. This can mean a risk of serious personal injury. Therefore disconnect the battery when the machine is not under close supervision.

General safety instructions



WARNING: Read the warning instructions that follow before you use the product.

- This product is a dangerous tool if you are not careful or if you use the product incorrectly. This product can cause serious injury or death to the operator or others.
- Do not use the product if it is changed from its initial specification. Do not change a part of the product without approval from the manufacturer. Only use parts that are approved by the manufacturer. Injury or death is a possible result of incorrect maintenance.
- Do a check of the product before use. See, *Safety on page 4* and *Maintenance on page 21*. Do not use a defective product. Do the safety checks, maintenance and service instructions described in this manual.
- Children should be supervised to ensure that they do not play with the product. Never allow children or other persons not trained in the use of the product and/or

the battery to use or service it.

- Keep the product in a locked area to prevent access for children or persons that are not approved.

Note: Local laws can regulate the age of the operator.

Safety instructions for operation



WARNING: Read the warning instructions that follow before you use the product.

- If you encounter a situation where you are uncertain how to proceed you should ask an expert. Contact your dealer or your service workshop. Avoid all usage which you consider to be beyond your capability.
- Never use the product if you are fatigued, while under the influence of alcohol or drugs, medication or anything that could affect your vision, alertness, coordination or judgment.
- Faulty cutting attachment can increase the risk of accidents.
- Do not allow children to use or be in the vicinity of the product. Since the product is easy to start, children may be able to start it if they are not kept under full surveillance. This can mean a risk of serious personal injury. Disconnect the battery when the product is not under close supervision.
- Ensure that no people or animals come closer than 15 metres while you work. When several operators are working in the same area the safety distance should be at least 15 metres. Otherwise there is a risk of serious personal injury. Stop the product immediately if anyone approaches. Never swing the product around without first checking behind you to make sure that no one is within the safety zone.
- Ensure that people, animals or other things can not affect your control of the product or that they do not come in contact with the cutting attachment or loose objects that are thrown out by the cutting attachment. However, do not use the product unless you are able to call for help in the event of an accident.
- Always inspect the working area. Remove all loose objects such as stones, broken glass, nails, steel wire, string, etcetera, that could be

thrown out or become wrapped around the cutting attachment.

- Make sure that you can move and stand safely. Check the area around you for possible obstacles (roots, rocks, branches, ditches, etcetera) in case you have to move suddenly. Take great care when you work on sloping ground.
- Keep a good balance and a firm foothold at all times. Do not overreach.
- Deactivate the product before you move to another area. Attach the transport guard when the product is not in use.
- Never put the product down unless you have deactivated it. Do not leave the product unsupervised when it is switched on.
- Remove the battery before you pass the product to another person.
- Make sure that no clothes or parts of the body come in contact with the cutting attachment when the product is activated. Keep the product below waist level.
- If anything jams in the cutting attachment while you operate the product, stop and

deactivate the product. Make sure that the cutting attachment stops completely. Remove the battery before you clean, inspect or repair the product and/or the cutting equipment.

- Keep your hands and feet away from the cutting attachment until it has stopped completely when the product is deactivated.
- Watch out for stumps of branches that can be thrown out when you cut. Do not cut too close to the ground where stones and other objects can be thrown out.
- Watch out for thrown objects. Always wear approved eye protection. Never lean over the cutting attachment guard. Stones, rubbish, etc., can be thrown up into the eyes which can cause blindness or serious injury.
- Listen out for warning signals or shouts when you wear hearing protection. Always remove your hearing protection as soon as the product stops.
- Never work from a ladder, stool or any other raised position that is not fully secured.
- If any unwanted vibrations occur, tap out new line to give

the line the correct length to stop the vibrations.

- Overexposure to vibration can lead to circulatory damage or nerve damage in persons who have poor circulation. Speak to your physician if you experience symptoms of overexposure to vibration. Such symptoms include numbness, loss of feeling, tingling, pricking, pain, loss of strength, changes in skin colour or condition. These symptoms usually show in the fingers, hands or wrists.
- Always hold the product with both hands. Hold the product on the right side of your body.
- Do not remove the cut material, or let other persons remove cut material, while the product is on or the cutting equipment rotates, as this can result in serious injury.
- Always stop the product, remove the battery and make sure that the cutting equipment does not rotate before you remove material that is wound around the blade shaft or caught between the guard and the cutting attachment.

Personal protective equipment



WARNING: Read the warning instructions that follow before you use the product.

- Always use approved personal protective equipment when you use the product. Personal protective equipment cannot fully prevent injury but it decreases the degree of injury if an accident does occur. Let your dealer help you select the right equipment.
- Use a protective helmet where there is a risk of falling objects.

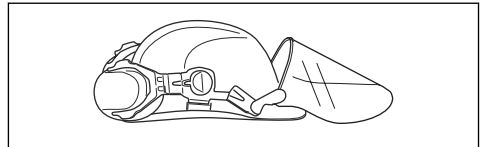

- Long term exposure to noise can result in damaged hearing. In general, battery powered products are relatively quiet but damage can result from a combination of noise level and long usage. recommends that operators use hearing protectors when using products for a longer coherent time of a day. Continual and regular users

should have their hearing checked regularly.

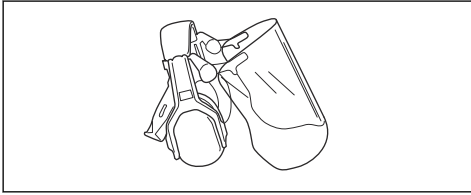

WARNING: Hearing protectors limit the ability to hear sounds and warning signals.

- Use approved eye protection. If you use a visor, you must also use approved protective goggles. Approved protective goggles must comply with the ANSI Z87.1 standard in the USAs or EN 166 in EU countries.

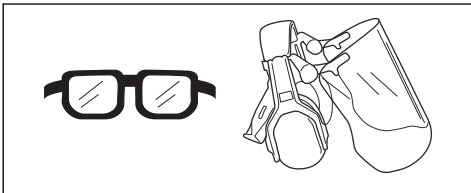

- Use gloves when necessary, for example when you attach, examine or clean the cutting equipment.

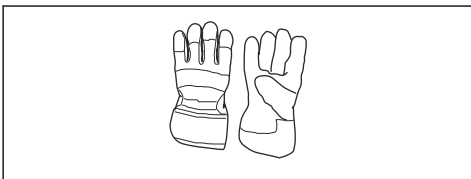

- Use sturdy non-slip boots.



- Use clothing made of a strong fabric. Always use heavy, long pants and long sleeves. Do not use loose clothing that can catch on twigs and branches. Do not wear jewelry, short pants, sandals or go with bare feet. Put your hair up safely above shoulder level.
- Keep first aid equipment close at hand.

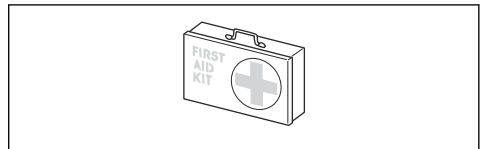

Safety devices on the product



WARNING: Read the warning instructions that follow before you use the product.

- In this section the product's safety features, its purpose and how checks and maintenance should be carried out to ensure that it operates correctly. See instructions

under the heading *Product overview on page 2* to find where these parts are located on your product.

- The life span of the product can be reduced and the risk of accidents can increase if product maintenance is not carried out correctly and if service and/or repairs are not carried out professionally. If you need further information please contact your nearest servicing dealer.
- Never use a product with defective safety components. The product's safety equipment must be inspected and maintained as described in this section. If your product fails any of these checks, contact your service agent to get it repaired.
- All servicing and repair work on the machine requires special training. This is especially true of the machine's safety equipment. If your machine fails any of the checks described below you must contact your service agent. When you buy any of our products we guarantee the availability of professional repairs and service. If the retailer who sells your machine is not a servicing

dealer, ask him for the address of your nearest service agent.

To do a check of the keypad

1. Push and hold the start/stop button (A).

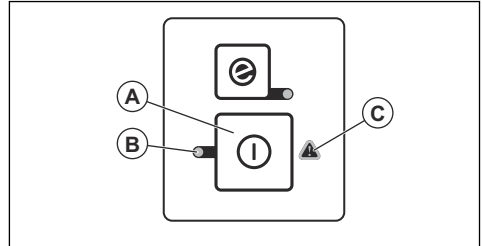

- a) The product is on when the LED (B) comes on.
 - b) The product is off when the LED (B) comes off.
2. Refer to *Troubleshooting on page 22* if the warning indicator (C) comes on or flashes.

To do a check of the power trigger lockout

The power trigger lockout is designed to prevent accidental operation. When you press the lock (A) it releases the power trigger (B). When you release the handle, the power trigger and the power trigger lockout both move back to their original positions. This movement is operated by independent springs.

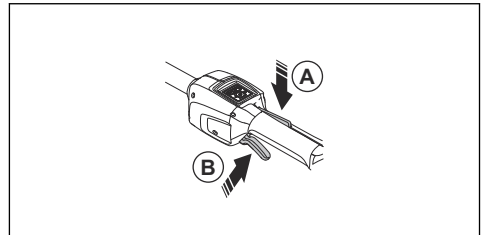

1. Make sure that the power trigger is locked when the lock is in its original position.

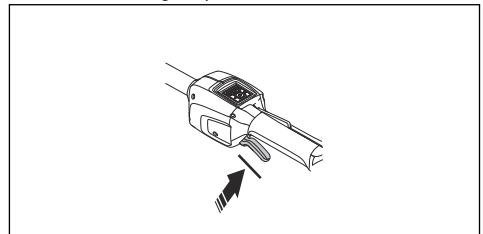

2. Press the power trigger and make sure it returns to its original position when you release it.

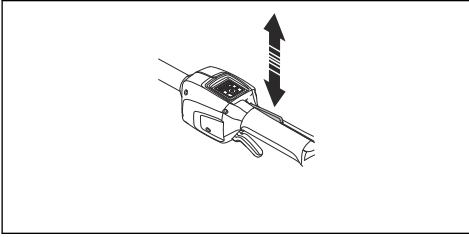

3. Make sure that the power trigger and the lock moves freely and that the return spring works properly.

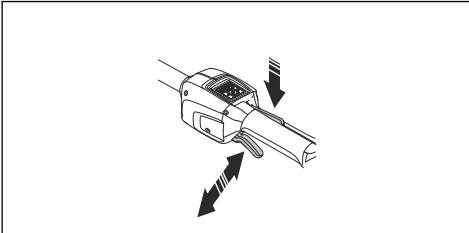

4. Start the product, see *To start the product on page 19*.
5. Apply full throttle.
6. Release the power trigger and make sure that the cutting attachment stops and remains still.

To do a check of the cutting attachment guard



WARNING: Do not use a cutting attachment without an approved and correctly attached cutting attachment guard. Always use the recommended cutting attachment guard for the cutting attachment that you use, see *Accessories on page 26*. If an incorrect or faulty cutting attachment guard is attached this

can cause serious personal injury.

The cutting attachment guard stops objects that eject in the direction of the operator. It also prevents injuries that occur if you touch the cutting attachment.

1. Stop the motor.
2. Do a visual check for damages, for example cracks.

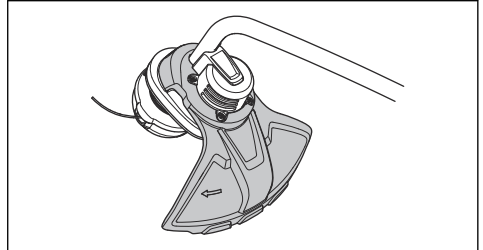

3. Replace the cutting attachment guard if it is damaged.

Cutting equipment

Select correct cutting equipment and do maintenance on the cutting equipment to:

- Get maximum cutting performance.
- Increase lifetime of the cutting equipment.



WARNING: Only use cutting attachments with the guards we recommend! See *Accessories on page 26*. Refer to the instructions for the cutting attachment to find the correct way to load the trimmer line and the correct trimmer line diameter.



WARNING: A defective cutting attachment may increase the risk of accidents.



WARNING: Always stop the engine before you do the work on the cutting attachment. This continues to rotate after you release the throttle. Make sure that the cutting attachment has stopped fully and disconnect the spark plug cap before you start the work on it.

Trimmer head



WARNING: Always make sure the trimmer line is wound tightly and evenly around the drum to prevent harmful vibration.



- Only use recommended trimmer heads and trimmer lines.
- Only use recommended cutting attachments.
- Smaller machines requires small trimmer heads and vice versa.
- The length of the trimmer line is important. A longer trimmer line requires greater engine power than a shorter trimmer line of the same diameter.
- Make sure that the cutter on the trimmer guard is intact. This cuts the trimmer line to the correct length.
- Soak the trimmer line in water for a couple of days before use to increase the life length.

Battery safety



WARNING: Read the warning instructions that follow before you use the product.

- Only use the BLi battery. Refer to *Accessories on page 26*. The battery is software encrypted.
- Use the BLi battery that is rechargeable as a power supply for the related Husqvarna products only. To prevent injury, do not use the battery as a power supply for other devices.
- Risk of electrical shock. Do not connect the battery terminals to keys, coins, screws or other metal. This can cause a short circuit of the battery.
- Do not use non-rechargeable batteries.
- Do not put objects into the air slots of the battery.
- Keep the battery away from sunlight, heat or open flame. The battery can cause burns and/or chemical burns.
- Keep the battery away from microwaves and high pressure.
- Do not try to disassemble or break the battery.

- If the battery leaks, do not let the liquid touch your body or eyes. If you have touched the liquid, clean the area with a large quantity of water and soap, and get medical aid. If you get liquid in your eyes, do not rub but flush with water for a minimum of 15 minutes and get medical aid.
- Use the battery in temperatures between -10 °C (14 °F) and 40 °C (114 °F).
- Do not clean the battery or the battery charger with water. Refer to *To clean the product, the battery and the battery charger on page 21*.
- Do not use a defective or damaged battery.
- Keep batteries in storage away from metal objects such as nails, screws or jewelry.
- Keep the battery away from children.

Battery charger safety



WARNING: Read the warning instructions that follow before you use the product.

- Risk of electrical shock or short circuit if the safety instructions are not obeyed.
- Do not use other battery chargers than the one supplied for your product. Only use chargers when you charge BLi replacement batteries.
- Do not try to disassemble the battery charger.
- Do not use a defective or damaged battery charger.
- Do not lift the battery charger by the power cord. To disconnect the battery charger from a mains socket, pull out the plug. Do not pull the power cord.
- Keep all cables and extension leads away from water, oil and sharp edges. Make sure that the cable is not caught between objects, for example, doors, fences or equivalent.
- Do not use the battery charger near flammable materials or materials that can cause corrosion. Make sure that the battery charger is not covered. Pull out the plug to the battery charger if there is smoke or fire.
- Only charge the battery indoors in a location with good airflow and away from sunlight. Do not charge the battery outdoors. Do not charge the battery in wet conditions.
- Only use the battery charger where the temperature is

between 5 °C (41 °F) and 40 °C (104 °F). Use the charger in an environment which has a good airflow, dry and free from dust.

- Do not put objects into the cooling slots of the battery charger.
- Do not connect the battery charger terminals to metal objects as this can short circuit the battery charger.
- Use approved mains sockets that are not damaged. Make sure that the cord of the battery charger is not damaged. If extension cables are used, make sure that the extension cables are not damaged.

Safety instructions for maintenance



WARNING: Read the warning instructions that follow before you do maintenance on the product.

- Remove the battery before you do maintenance, other

checks or assemble the product.

- The operator must only do the maintenance and servicing shown in this operator's manual. Turn to your servicing dealer for maintenance and servicing of a larger extension.
- Do not clean the battery or the battery charger with water. Strong detergent can cause damage to the plastic.
- If you do not do maintenance, it decreases the life cycle of the product and increases the risk of accidents.
- Special training is necessary for all servicing and repair work, especially for the safety devices on the product. If not all checks in this operator's manual are approved after you have done maintenance, turn to your servicing dealer. We guarantee that there are professional repairs and servicing available for your product.
- Only use original spare parts.

Assembly

Introduction



WARNING: Read and understand the safety chapter before you assemble the product.

To attach the loop handle

1. Attach the loop handle to the shaft in compliance with the illustration and tighten.

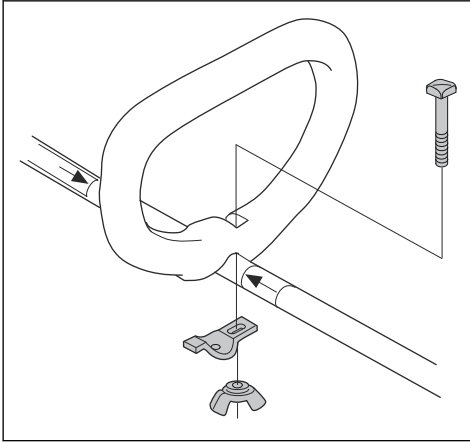

2. Make sure that the loop handle attaches between the arrows on the shaft.

Operation

Introduction



WARNING: Read and understand the safety chapter before you use the product.

Before you operate the product

- Examine the work area to make sure that you know the type of terrain. Examine the slope of the ground and if there are obstacles such as stones, branches and ditches.
- Do an overhaul inspection of the product.
- Do the safety inspections, maintenance and servicing that are given in this manual.
- Examine the motor for dirt or cracks. Use a brush to clean the motor from grass and leaves. Use gloves when it is necessary.
- Examine the trimmer head and cutting attachment guard for damages or cracks. Replace the trimmer head and cutting attachment guard if they are hit or if they have cracks.
- Make sure that all nuts and screws are tight.
- Make sure that all covers, guards, handles and the cutting equipment are correctly attached and not damaged before you start the product.

To connect the battery charger

1. Connect the battery charger to the voltage and frequency that is specified on the rating plate.
2. Put the plug in a grounded socket outlet. The LED on the battery charger flashes green one time.

Note: The battery does not charge if the battery temperature is more than 50 °C/122 °F. If the temperature is more than 50 °C/122 °F, the battery charger makes the battery become cool before the battery charges.

To charge the battery

Note: Charge the battery if it is the first time that you use it. A new battery is only 30% charged.

1. Make sure that the battery is dry.
2. Put the battery in the battery charger.

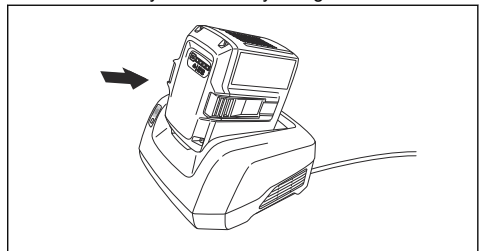

3. Make sure that the green charging light on the battery charger comes on. That means that the battery is connected correctly to the battery charger.

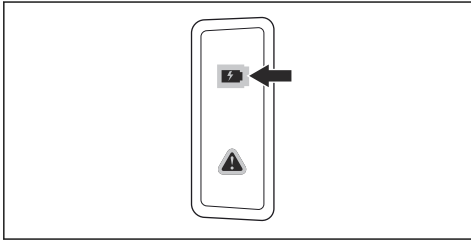

4. When all LEDs on the battery come on, the battery is fully charged.

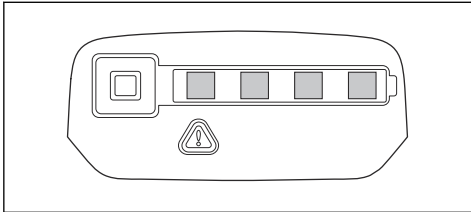

5. To disconnect the battery charger from the mains socket, pull the plug. Do not pull the cable.
6. Remove the battery from the battery charger.

Note: Refer to the battery and battery charger manuals for more information.

To connect the battery to the product



WARNING: Only use Husqvarna original batteries with the product.

1. Make sure that the battery is fully charged.
2. Push the battery into the battery holder of the product. The battery locks into position when you hear a click.

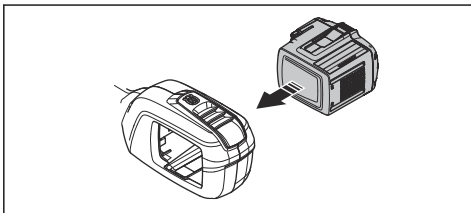

CAUTION: If the battery does not move easily into the battery holder, the battery is not installed correctly. This can cause damage to the product.

3. Make sure that the battery is installed correctly.

Battery information

Refer to the operator's manual of the battery for information about how to use the battery.

To start the product

1. Push and hold the start/stop button until the green LED comes on.

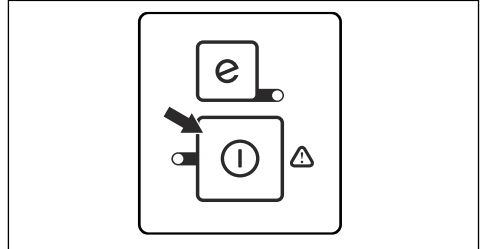

2. Use the power trigger to control the speed.

To start the SavE function

The product has a power saving function. The SavE function gives the longest operation time from the battery.

1. Push the SavE button to start the function. The green LED comes on to show that the function is on.

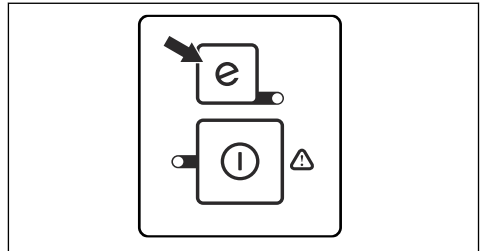

2. Push the SavE button again to stop the SavE function.

Automatic shutdown function

The product has a shutdown function that stops the product if it is not used. The green LED for start/stop indication comes off and the product stops after 60 seconds.

To operate the product

To trim the grass

1. Hold the trimmer head immediately above the ground at an angle. Do not push the trimmer line into the grass.

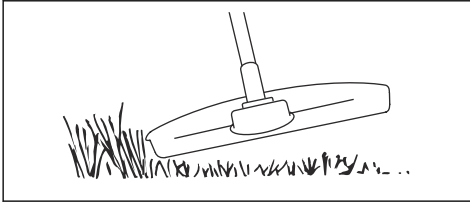

2. Decrease the length of the trimmer line by 10-12 cm / 4-4.75 in.
3. Decrease the engine speed to decrease the risk of damage to plants.
4. Use 80 % throttle when you cut grass near objects.

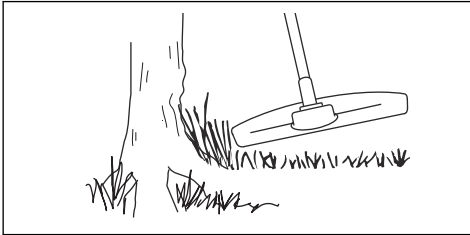

To clear grass

1. Keep the trimmer head above the ground.
2. Tilt the trimmer head.
3. Cut with the end of the trimmer line around objects in the work area.



CAUTION: Cut grass. Other objects that are hit by the trimmer line, increases the wear on the trimmer line.

4. Use 80% speed when you cut and clear vegetation. This decreases the wear on the trimmer head and trimmer line.

To cut the grass

1. Make sure that the trimmer line is parallel to the ground when you cut the grass.

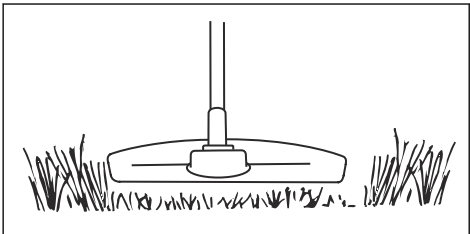

2. Do not push the trimmer head to the ground. This can cause damage to the product.
3. Move the product from side to side when you cut grass. Use full speed.

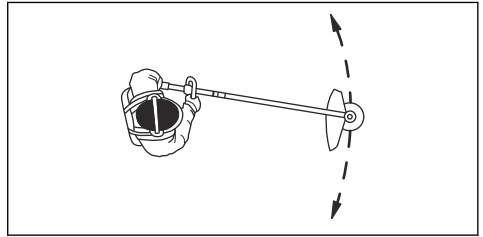

To sweep the grass

The airflow from the rotating trimmer cord can be used to remove cut grass from an area.

1. Hold the trimmer head and its cord parallel to the ground and above the ground.
2. Apply full throttle.
3. Move the trimmer head from side to side and sweep the grass.



WARNING: Clean the trimmer head cover each time you assemble new trimmer cord to prevent unbalance and vibrations in the handles. Also do a check of the other parts of the trimmer head and clean it if necessary.

To stop the product

1. Release the power trigger or the power trigger lockout.
2. Push the start/stop button until the green LED is off.
3. Push the release buttons on the battery and pull the battery out.

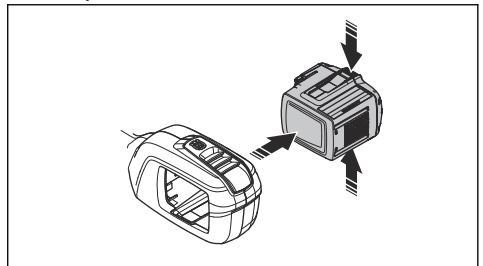

Maintenance

Introduction



WARNING: Read and understand the safety chapter before you do maintenance work on the product.



WARNING: Remove the battery before you do maintenance on the product.

Maintenance schedule



WARNING: Remove the battery before you do maintenance.

The following is a list of the maintenance steps that you must do on the product. See *Maintenance on page 21* for more information.

Maintenance	Daily	Weekly	Monthly
Clean the external parts of the product with a dry cloth. Do not use water.	X		
Examine that the start and stop button works correctly and is not damaged.	X		
Make sure that the power trigger and the power trigger lockout function correctly from a safety point of view.	X		
Make sure that all controls work and are not damaged.	X		
Keep the handles dry, clean and free from oil and grease.	X		
Make sure that the cutting attachment is not damaged. Replace the cutting attachment if it is damaged.	X		
Make sure that the cutting attachment guard is not damaged. Replace the cutting attachment guard if it is damaged.	X		
Make sure that the screws and nuts are tight.	X		
Make sure that the battery release buttons on the battery works and locks the battery in the product.	X		
Examine that the battery charger is not damaged and function correctly.	X		
Make sure that the battery is not damaged.	X		
Make sure that the battery is charged.	X		
Make sure that the battery charger is not damaged.	X		
Examine all cables, couplings and connections. Make sure they are not damaged and free from dirt.		X	
Do a check of the connections between the battery and the product. Do a check of the connection between the battery and the battery charger.			X

To examine the battery and the battery charger

1. Examine the battery for damages, for example cracks.
2. Examine the battery charger for damages, for example cracks.
3. Make sure that the connection cord of the battery charger is not damaged and that there are no cracks in it.

To clean the product, the battery and the battery charger

1. Clean the product with a dry cloth after use.
2. Clean the battery and battery charger with a dry cloth. Keep the battery guide tracks clean.
3. Make sure that the terminals on the battery and the battery charger are clean before the battery is put in the battery charger or the product.

To do a check of the trimmer line

Only use the recommended trimmer line. See the illustration on the last pages of the manual.

1. Put the cord into the hole on the cover of the product to make sure it follows the recommendation.

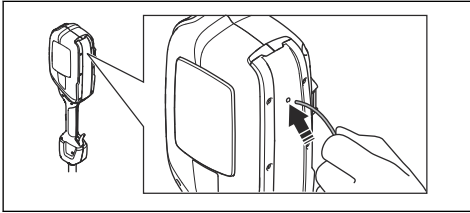

To replace the trimmer head

Note: To increase the life of the cord it can be soaked in water for a couple of days before it is assembled. This will make the cord tougher.

1. Press the snap-in clips on the trimmer head and remove the trimmer head and trimmer line.

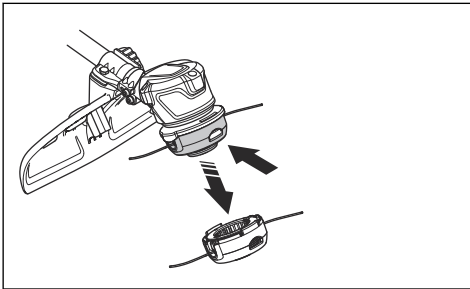

2. Pull out the line chute assembly.

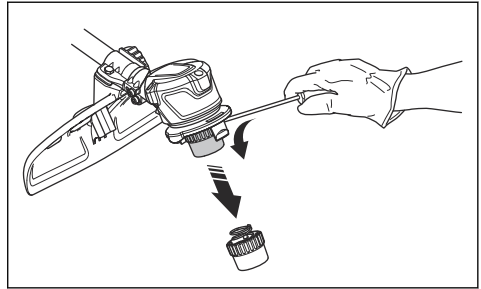

3. Remove the nut that holds the trimmer head and the drive disc.

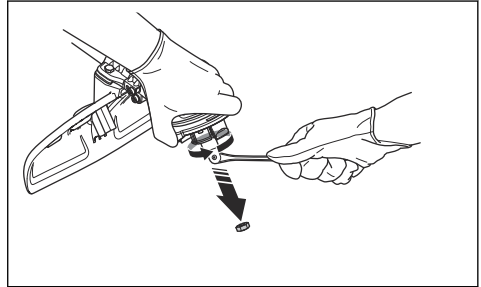

4. Replace the trimmer head.
5. Install the nut.
6. Install the line chute assembly.
7. Install the trimmer head.

Troubleshooting

Keypad

LED display	Possible faults	Possible action
Green activate LED flashing	Low battery voltage.	Charge the battery.
Red error LED flashing	Overload.	The cutting attachment is jammed. deactivate the product. Remove the battery. Clean the cutting attachment from unwanted materials.
	Temperature deviation.	Let the product cool down.
	The power trigger and the activate button are pressed at the same time.	Release the power trigger and the product is active.
The product does not start	Dirt in the battery connectors.	Clean the battery connectors with compressed air or a soft brush.

LED display	Possible faults	Possible action
Error LED is lit with red light	The product needs servicing.	Contact your servicing agent.

Battery

Problem	Possible faults	Possible solution
Green LED flashes.	Low battery voltage.	Charge the battery.
Red error LED flashes.	The battery is empty.	Charge the battery.
	Temperature deviation.	Use the battery in temperatures between -10°C (14°F) and 40°C (104°F).
	Overvoltage.	Remove the battery from the battery charger.
Red error LED comes on.	Cell difference is too much (1V).	Speak to your servicing dealer.

Battery charger

LED display	Possible faults	Possible action
Error LED flashes	Temperature deviation.	Use the battery charger in temperatures between 5°C (41°F) and 40°C (104°F).
	Overvoltage.	Make sure that the mains voltage is the same as the shown voltage value on the rating plate on the product.
		Remove the battery from the battery charger.
Error LED comes on		Speak to your service agent.

Transportation, storage and disposal

Transportation and storage

- The supplied Li-ion batteries obey the Dangerous Goods Legislation requirements.
- Obey the special requirement on package and labels for commercial transportation, including by third parties and forwarding agents.
- Speak to a person with special training in dangerous material before you send the product. Obey all applicable national regulations.
- Use tape on open contacts when you put the battery in a package. Put the battery in the package tightly to prevent movement.
- Remove the battery for storage or transportation.
- Put the battery and the battery charger in a space that is dry and free from moisture and frost.
- Do not keep the battery in an area where static electricity can occur. Do not keep the battery in a metal box.
- Put the battery in storage where the temperature is between 5 °C (41 °F) and 25 °C (77 °F) and away from open sunlight.
- Put the battery charger in storage where the temperature is between 5 °C (41 °F) and 45 °C (113 °F) and away from open sunlight.
- Charge the battery 30% to 50% before you put it in storage for long periods.
- Put the battery charger in storage in a space that is closed and dry.
- Keep the battery away from the battery charger during storage. Do not let children and other not approved persons to touch the equipment. Keep the equipment in a space that you can lock.

- Clean the product and do a full servicing before you put the product in storage for a long time.
- Use the transportation guard on the product to prevent injuries or damage on the product during transportation and storage.
- Attach the product safely during transportation.

Disposal of the battery, battery charger and product

The symbol below means that the product is not domestic waste. Recycle it at a recycling station for

electrical and electronic equipment. This helps to prevent damage to the environment and to persons.

Speak to local authorities, domestic waste service or your dealer for more information.

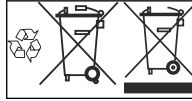

Note: The symbol shows on the product or package of the product.

Technical data

Technical data

	315iC
Motor	
Motor type	PMDC (4-brush)
Speed of output shaft, rpm	5800
Cutting width, mm	330
Weight	
Weight without battery, kg	3.1
Weight with battery, kg	4.3
Water protection level	
All weather use	Yes
Noise emissions¹	
Sound power level, measured dB(A)	88
Equivalent sound pressure level at the operator's ear, measured refer to EN ISO 22868, dB(A), min./max.	93
Noise levels²	
Equivalent sound pressure level at the operator's ear, measured refer to EN ISO 22868, dB(A)	76
Vibration levels³	
Vibration levels (a_h) at handles, measured refer to EN 11806 and ISO 22867, m/s^2	
Equipped with trimmer head (original), left/right	1.9/1.3

Approved batteries

Only use original BLi batteries for this product.

Approved battery chargers

Battery charger	QC330	QC500
Input voltage, V	100-240	100-240
Frequency, Hz	50-60	50-60

¹ Noise emissions in the environment measured as sound power (L_{WA}) in conformity with EC directive 2000/14/EC. The difference between guaranteed and measured sound power is that guaranteed sound power also includes dispersion in the measurement result and the variations between different products of the same model refer to Directive 2000/14/EC.

² Reported data for equivalent sound pressure level for the machine has a typical statistical dispersion (standard deviation) of 1 dB(A).

³ Reported data for equivalent vibration level has a typical statistical dispersion (standard deviation) of 1 m/s^2 .

Battery charger	QC330	QC500
Power, W	330	500

Accessories

Approved accessories

Approved accessory	Type	Cutting attachment guard, art no
Trimmer head	T25B (Ø 2.0 mm line)	577 96 51-01

EC Declaration of Conformity

EC Declaration of Conformity

Husqvarna AB, SE-561 82 Huskvarna, Sweden, tel: +46-36-146500, declares that the battery trimmer **Husqvarna 315iC** with serial numbers dating from 2016 and onwards (the year is clearly stated on the rating plate, followed by the serial number), comply with the requirements of the COUNCIL'S DIRECTIVE:

- of May 17, 2006 "relating to machinery" **2006/42/EC**.
- of February 26, 2014 "relating to electromagnetic compability" **2014/30/EU**.
- of May 8, 2000 "relating to the noise emissions in the environment" **2000/14/EC**.
- of June 8, 2011 "restriction of use of certain hazardous substances" **2011/65/EU**.

0404, SMP Svensk Maskinprovning AB, Box 7035, SE-750 07 Uppsala, Sweden, has performed conformity assessment according to Annex VI of Directive 2000/14/EC and issued a certificate with the number: **01/1610/007**

VDE-Prüf- und Zertifizierungsinstitut GmbH, Meriansstrasse 28, DE-63069 Offenbach (Am Main), Germany, has performed voluntary type examination on behalf of Husqvarna AB.

For information relating to noise emissions, refer to *Technical data on page 25*.

The following standards have been applied:

**IEC 60335-1:2010+A1:2013, EN
60335-1:2012+A11:2014, EN 62133:2011, EN
60335-2-29:2011, EN ISO 11806-1:2011, EN
50581:2012**

Huskvarna, 2018-09-28



Pär Martinsson, Development Manager (Authorized representative for Husqvarna AB and responsible for technical documentation)

T25B



1

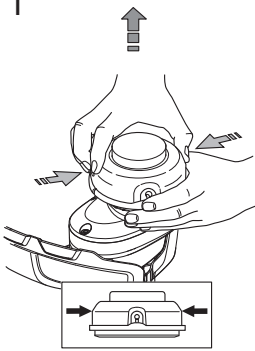

2

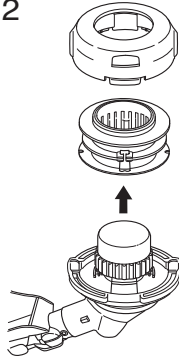

3

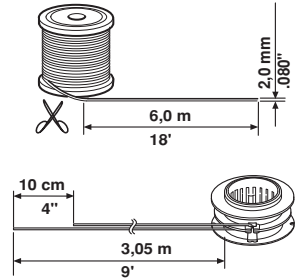

4

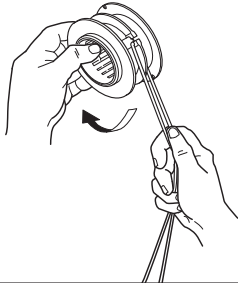

5

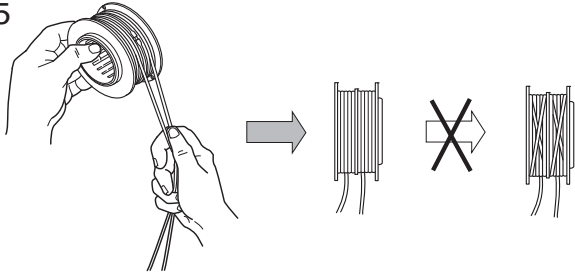

6

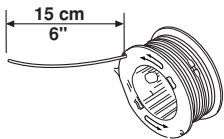

7

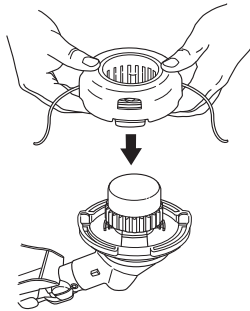

8

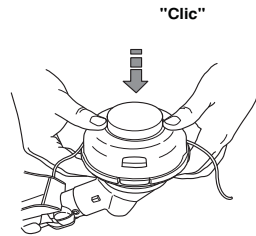

9

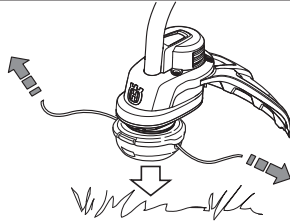



www.husqvarna.com

Original instructions

1140354-26



2018-11-26