

# INSTALLATION AND REPAIR PARTS MANUAL

42 INCH REPLACEMENT MOWER DECK  
FOR LAWN TRACTORS

PART NUMBER 597 13 45-01

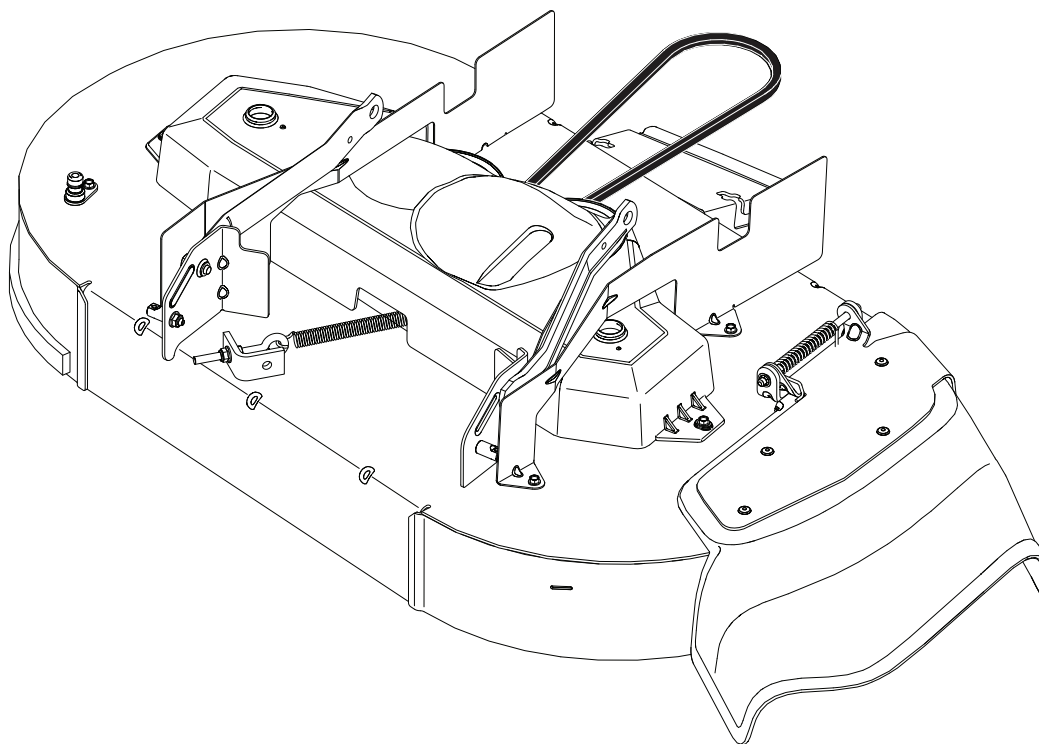



# SAFETY RULES

## Safe Operation Practices for Ride-On Mowers



**DANGER: THIS CUTTING MACHINE IS CAPABLE OF AMPUTATING HANDS AND FEET AND THROWING OBJECTS. FAILURE TO OBSERVE THE FOLLOWING SAFETY INSTRUCTIONS COULD RESULT IN SERIOUS INJURY OR DEATH.**



**WARNING:** In order to prevent accidental starting when setting up, transporting, adjusting or making repairs, always disconnect spark plug wire and place wire where it cannot contact spark plug.



**WARNING:** Do not coast down a hill in neutral, you may lose control of the tractor.



**WARNING:** Tow only the attachments that are recommended by and comply with specifications of the manufacturer of your tractor. Use common sense when towing. Operate only at the lowest possible speed when on a slope. Too heavy of a load, while on a slope, is dangerous. Tires can lose traction with the ground and cause you to lose control of your tractor.



### WARNING

Engine exhaust, some of its constituents, and certain vehicle components contain or emit chemicals known to the State of California to cause cancer and birth defects or other reproductive harm.



### WARNING

Battery posts, terminals and related accessories contain lead and lead compounds, chemicals known to the State of California to cause cancer and birth defects or other reproductive harm. Wash hands after handling.

## I. CHILDREN



**WARNING! CHILDREN CAN BE INJURED BY THIS EQUIPMENT.** The American Academy of Pediatrics recommends that children be a minimum of 12 year of age before operating a pedestrian controlled lawn mower and a minimum of 16 years of age before operating a riding lawn mower.



**WARNING! CHILDREN CAN BE SERIOUSLY INJURED OR KILLED BY THIS EQUIPMENT.** Carefully read and follow all of the safety instructions below.

Tragic accidents can occur if the operator is not alert to the presence of children. Children are often attracted to the machine and the mowing activity. Never assume that children will remain where you last saw them.

- Keep children out of the mowing area and in the watchful care of a responsible adult **other than** the operator.

- Be alert and turn machine off if a child enters the area.
- Before and while backing, look behind and down for small children.
- Never carry children, even with the blades shut off. They may fall off and be seriously injured or interfere with safe machine operation. Children who have been given rides in the past may suddenly appear in the mowing area for another ride and be run over or backed over by the machine.
- Never allow children to operate the machine.
- Use extreme caution when approaching blind corners, shrubs, trees, or other objects that may block your view of a child.

## II. GENERAL OPERATION

- Read, understand, and follow all instructions on the machine and in the manual before starting.
- Do not put hands or feet near rotating parts or under the machine. Keep clear of the discharge opening at all times.
- Only allow responsible adults, who are familiar with the instructions, to operate the machine.
- Clear the area of objects such as rocks, toys, wire, etc., which could be picked up and thrown by the blades.
- Ensure the area is clear of bystanders before operating. Stop machine if anyone enters the area.
- Never carry passengers.
- Do not mow in reverse unless absolutely necessary. Always look down and behind before and while backing.
- Never direct discharged material toward anyone. Avoid discharging material against a wall or obstruction. Material may ricochet back toward the operator. Stop the blades when crossing gravel surfaces.
- Do not operate machine without the entire grass catcher, discharge chute, or other safety devices in place and working.
- Slow down before turning.
- Never leave a running machine unattended. Always turn off blades, set parking brake, stop engine, and remove keys before dismounting.
- Disengage blades when not mowing. Shut off engine and wait for all parts to come to a complete stop before cleaning the machine, removing the grass catcher, or unclogging the discharge chute.
- Operate machine only in daylight or good artificial light.
- Do not operate the machine while under the influence of alcohol or drugs.
- Watch for traffic when operating near or crossing roadways.
- Use extreme caution when loading or unloading the machine into a trailer or truck.
- Always wear eye protection when operating machine.
- Use ear protectors to avoid damage to hearing.
- Data indicates that operators, age 60 years and above, are involved in a large percentage of riding mower-related injuries. These operators should evaluate their ability to operate the riding mower safely enough to protect themselves and others from serious injury.
- Follow the manufacturer's recommendation for wheel weights or counterweights.
- Keep machine free of grass, leaves or other debris build-up which can touch hot exhaust / engine parts and burn. Do not allow the mower deck to plow leaves or other debris which can cause build-up to occur. Clean any oil or fuel spillage before operating or storing the machine. Allow machine to cool before storage.



# SAFETY RULES

## Safe Operation Practices for Ride-On Mowers



### III. SLOPE OPERATION



**WARNING! When loading or unloading this machine, do not exceed the maximum recommended operation angle of 15°.**

Slopes are a major factor related to loss of control and tip-over accidents, which can result in severe injury or death. Operation on all slopes requires extreme caution. If you cannot back up the slope or if you feel uneasy on it, do not mow it.

- Mow up and down slopes, not across.
- Watch for holes, ruts, bumps, rocks, or other hidden objects. Uneven terrain could overturn the machine. Tall grass can hide obstacles.
- Choose a low ground speed so that you will not have to stop or shift while on the slope.
- Do not mow on wet grass. Tires may lose traction. Always keep the machine in gear when going down slopes.
- Do not shift to neutral and coast downhill.
- Avoid starting, stopping, or turning on a slope. If the tires lose traction, disengage the blades and proceed slowly straight down the slope.
- Keep all movement on the slopes slow and gradual. Do not make sudden changes in speed or direction, which could cause the machine to roll over.
- Use extreme caution while operating machine with grass catchers or other attachments; they can affect the stability of the machine. Do not use on steep slopes.
- Do not try to stabilize the machine by putting your foot on the ground.
- Do not mow near drop-offs, ditches, or embankments. The machine could suddenly roll over if a wheel is over the edge or if the edge caves in.
- If machine stops while going uphill, disengage blades, shift into reverse and back down slowly.
- Do not turn on slopes unless necessary, and then, turn slowly and gradually downhill, if possible.



### IV. TOWING

- Tow only with a machine that has a hitch designed for towing. Do not attach towed equipment except at the hitch point.
- Follow the manufacturer's recommendation for weight limits for towed equipment and towing on slopes.
- Never allow children or others in or on towed equipment.
- On slopes, the weight of the towed equipment may cause loss of traction and loss of control.
- Travel slowly and allow extra distance to stop.

### V. SERVICE

#### SAFE HANDLING OF GASOLINE

To avoid personal injury or property damage, use extreme care in handling gasoline. Gasoline is extremely flammable and the vapors are explosive.

- Extinguish all cigarettes, cigars, pipes, and other sources of ignition.
- Use only approved gasoline container.

- Never remove gas cap or add fuel with the engine running.
- Allow engine to cool before refueling.
- Never fuel the machine indoors.
- Never store the machine or fuel container where there is an open flame, spark, or pilot light such as on a water heater or other appliances.
- Never fill containers inside a vehicle or on a truck or trailer bed with plastic liner. Always place containers on the ground away from your vehicle when filling.
- Remove gas-powered equipment from the truck or trailer and refuel it on the ground. If this is not possible, then refuel such equipment with a portable container, rather than from a gasoline dispenser nozzle.
- Keep the nozzle in contact with the rim of the fuel tank or container opening at all times until fueling is complete. Do not use a nozzle lock-open device.
- If fuel is spilled on clothing, change clothing immediately.
- Never overfill fuel tank. Replace gas cap and tighten securely.

#### GENERAL SERVICE

- Never operate machine in a closed area.
- Keep all nuts and bolts tight to ensure the equipment is in safe working condition.
- Never tamper with safety devices. Never interfere with the intended function of a safety device or reduce the protection provided by a safety device. Check their proper operation regularly. NEVER operate a machine with a safety device that does not function properly.
- Keep machine free of grass, leaves, or other debris build-up. Clean oil or fuel spillage and remove any fuel-soaked debris. Allow machine to cool before storing.
- If you strike a foreign object, stop and inspect the machine. Repair, if necessary, before restarting.
- Never make any adjustments or repairs with the engine running.
- Check grass catcher components and the discharge chute frequently and replace with manufacturer's recommended parts, when necessary.
- Mower blades are sharp. Wrap the blade or wear gloves, and use extreme caution when servicing them.
- Check brake operation frequently. Adjust and service as required.
- Maintain or replace safety and instruction labels, as necessary.



Use ear protectors to avoid damage to hearing.



Always wear eye protection when operating machine.

# REMOVAL & INSTALLATION



**WARNING: TO AVOID SERIOUS INJURY, BEFORE PERFORMING ANY SERVICE OR ADJUSTMENTS:**

- Depress brake pedal fully and set parking brake.
- Ensure transaxle is in the neutral position.
- Place attachment clutch in "DISENGAGED" position.
- Turn ignition key to "STOP" and remove key.
- Ensure the blades and all moving parts have completely stopped.
- Disconnect spark plug wire from spark plug and place wire where it cannot come in contact with plug.

## TO REMOVE MOWER (See Fig. 1)

- Place attachment clutch in "DISENGAGED" position.
- Lower attachment lift lever to its lowest position.
- Remove mower belt from electric clutch pulley (M). See Mower Drive Belt Removal in "TO REPLACE MOWER BLADE DRIVE BELT" in this section.



**CAUTION: After rear lift links are disconnected, the attachment lift lever will be spring loaded. Have a tight grip on lift lever when changing position of the lever.**

- Go to either side of mower and disconnect mower suspension arm (A) from chassis and rear lift link (C) from rear mower bracket (D) - remove retainer springs and washers.
- Go to other side of mower and disconnect the suspension arm and rear lift link.
- Disconnect front link (E) from front mower bracket (H).
- Slide mower out from under right side of tractor.

## TO INSTALL MOWER (See Figs. 1 - 6)

Ensure tractor is on level surface and engage parking brake.

- Lower attachment lift lever to its lowest position.



**CAUTION: Lift lever is spring loaded. Have a tight grip on lift lever, lower it slowly and engage in lowest position.**

**NOTE:** Ensure mower side suspension arms (A) are pointing forward before sliding mower under tractor.

- Slide mower under tractor until it is centered under tractor.
- ATTACH MOWER SIDE SUSPENSION ARMS (A) TO CHASSIS - Position hole in arm over pin (B) on outside of tractor chassis and secure with retainer spring.
- Repeat on opposite side of tractor.

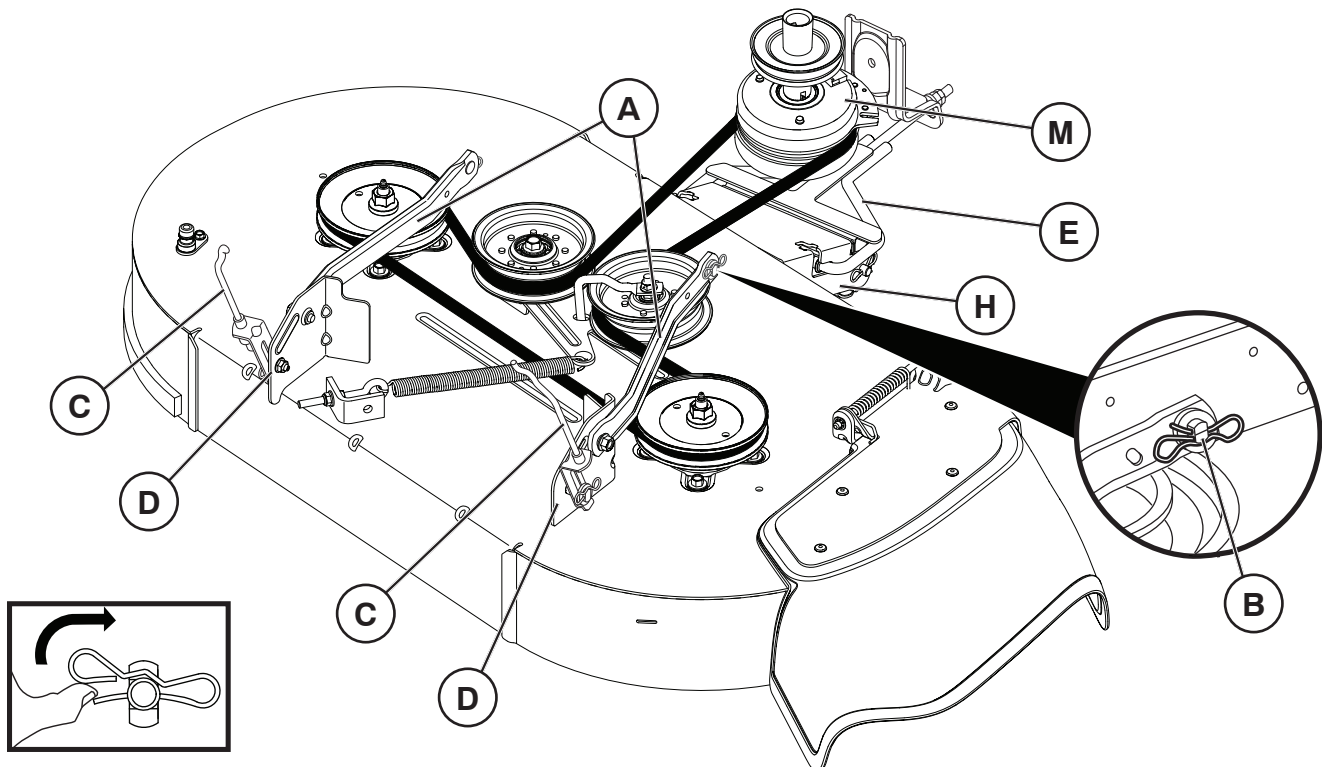

Fig. 1

# REMOVAL & INSTALLATION

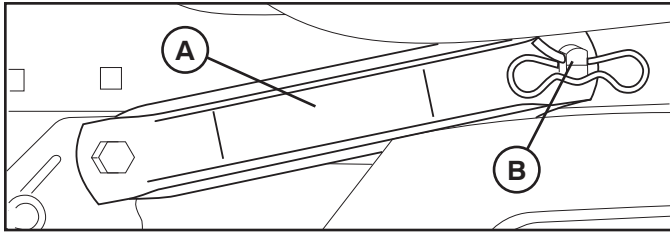

Fig. 2

- ATTACH FRONT LINK (E) - Insert flared ends of front link (E) into slots in front mower bracket (H).

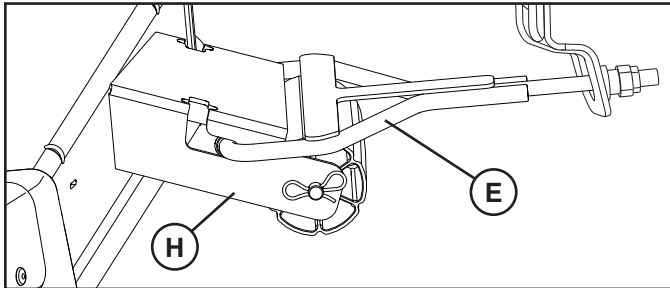

Fig. 3

- ATTACH REAR LIFT LINKS (C) - Lift rear corner of mower and position slot in link assembly over pin on rear mower bracket (D) and secure with washer and retainer spring.
- Repeat on opposite side of tractor.

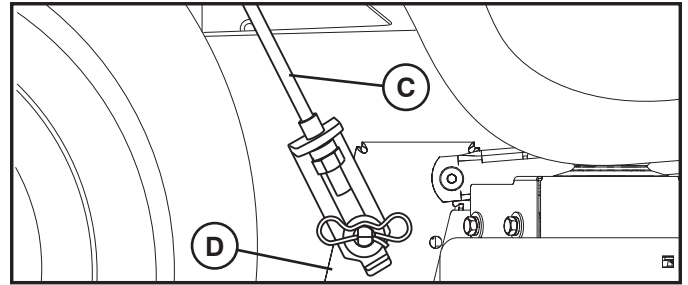

Fig. 4

- Check Front-To-Back Adjustment in "TO LEVEL MOWER" in this section.
- Install belt onto electric clutch pulley (M).

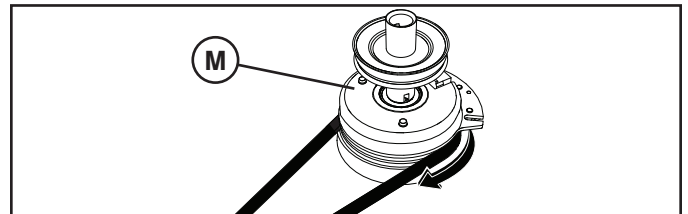

Fig. 5

**IMPORTANT:** CHECK BELT FOR PROPER ROUTING IN ALL MOWER PULLEY GROOVES.

- Raise attachment lift lever to highest position.

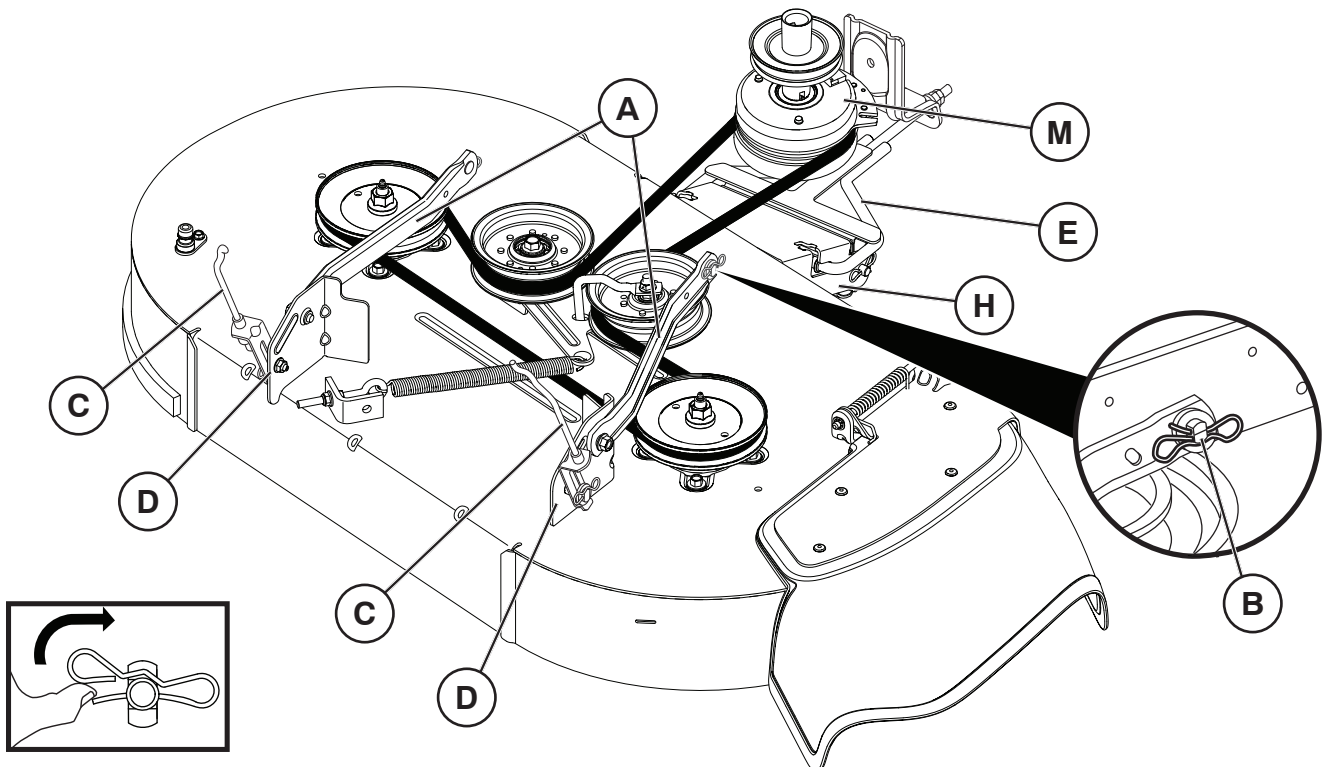

Fig. 6

# REMOVAL & INSTALLATION

## TO LEVEL MOWER

Ensure tires are properly inflated to the PSI shown on tires. If tires are over or under inflated, it may affect the appearance of your lawn and lead you to think the mower is not adjusted properly.

### VISUAL SIDE-TO-SIDE ADJUSTMENT (See Fig. 7)

- With all tires properly inflated and if your lawn appears unevenly cut, determine which side of mower is cutting lower.

**NOTE:** As desired, you can raise the low side of mower or lower the high side.

- Go to side of mower you wish to adjust.
- With a 3/4" or adjustable wrench, turn lift link adjustment nut (A) to the left to lower the mower, or, to the right to raise the mower.

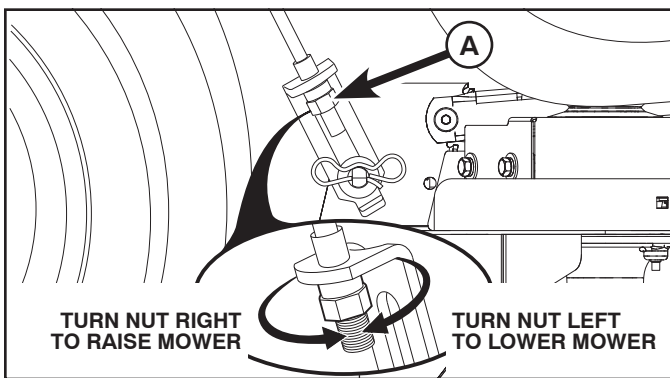

Fig. 7

**NOTE:** Each full turn of adjustment nut will change mower height about 3/16" (4,7 mm).

- Test your adjustment by mowing some uncut grass and visually checking the appearance. Readjust, if necessary, until you are satisfied with the results.

### PRECISION SIDE-TO-SIDE ADJUSTMENT (See Fig. 8)

- With all tires properly inflated, park tractor on level ground or driveway.



**CAUTION: Blades are sharp. Protect your hands with gloves and/or wrap blade with heavy cloth.**

- Raise mower to its highest position.
- At both sides of mower, position blade at side and measure the distance (A) from bottom edge of blade to the ground. The distance should be the same on both sides.
- If adjustment is necessary, see steps in Visual Adjustment instructions above.
- Recheck measurements, adjust if necessary until both sides are equal.

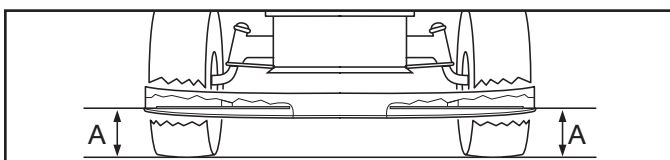

Fig. 8

### FRONT-TO-BACK ADJUSTMENT (See Figs. 9 & 10)

**IMPORTANT:** Deck must be level side-to-side.

To obtain the best cutting results, the mower blades should be adjusted so the front tip is 1/4" to 3/8" (6,3 to 9,5 mm) lower than the rear tip when the mower is in its highest position.



**CAUTION: Blades are sharp. Protect your hands with gloves and/or wrap blade with heavy cloth.**

- Raise mower to highest position.
- Position any blade so the tip is pointing straight forward. Measure distance (B) to the ground at front and rear tip of the blade.

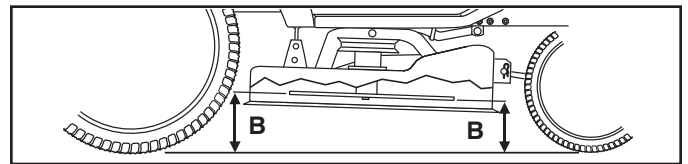

Fig. 9

- If front tip of blade is not 1/4" to 3/8" (6,3 to 9,5 mm) lower than the rear tip, go to the front of tractor.
- With an 11/16" or adjustable wrench, loosen jam nut A several turns to clear adjustment nut B.
- With a 3/4" or adjustable wrench, turn front link adjustment nut (B) clockwise (↻) (tighten) to raise the front of mower, or, counterclockwise (↺) (loosen) to lower the front mower.

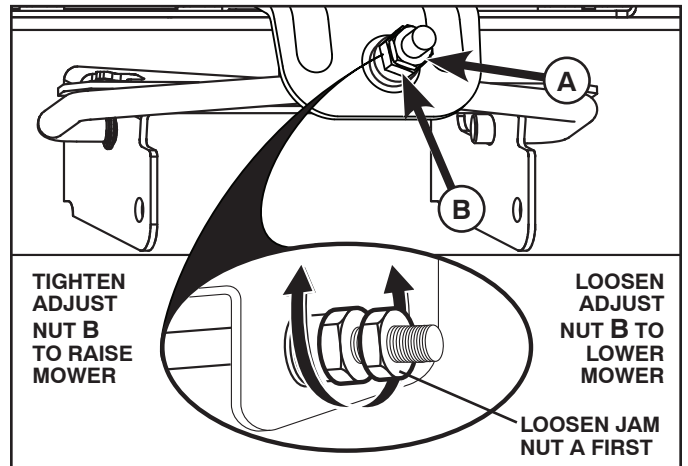

Fig. 10

**NOTE:** Each full turn of the adjustment nut will change mower height about 1/8" (3,1 mm).

- Recheck measurements, adjust if necessary until front tip of blade is 1/4" to 3/8" (6,3 to 9,5 mm) lower than the rear tip.
- Hold adjustment nut in position with wrench and tighten jam nut securely against adjustment nut.

# REMOVAL & INSTALLATION

## TO REPLACE MOWER BLADE DRIVE BELT

### MOWER DRIVE BELT REMOVAL (See Fig. 11)

- Park tractor on a level surface. Engage parking brake.
- Lower attachment lift lever to its lowest position.
- Remove mandrel covers.
- Remove any dirt or grass clippings which may have accumulated around mandrels and entire upper deck surface.
- Remove nut and pulley guard.
- Remove spring from eyebolt.
- Remove belt from all pulleys.
- Remove the belt from around the electric clutch on the engine shaft.

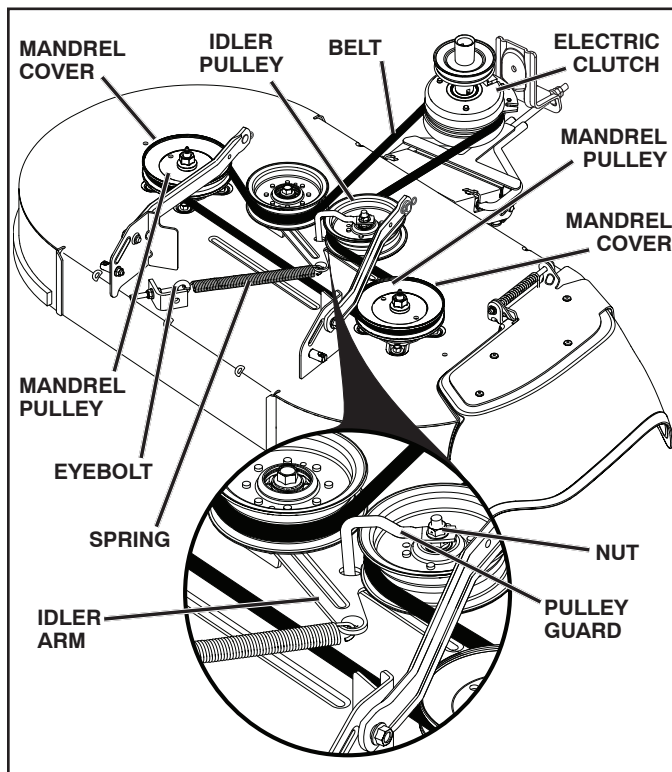

Fig. 11

### MOWER DRIVE BELT INSTALLATION (See Fig. 12 & 13)

**NOTE:** For ease in installing the deck belt, refer to the routing decal on the cutting deck.

- Place the belt around all pulleys.
- Double check belt routing to make sure it matches the routing decal, and that the belt does not have any twist. Correct if needed.

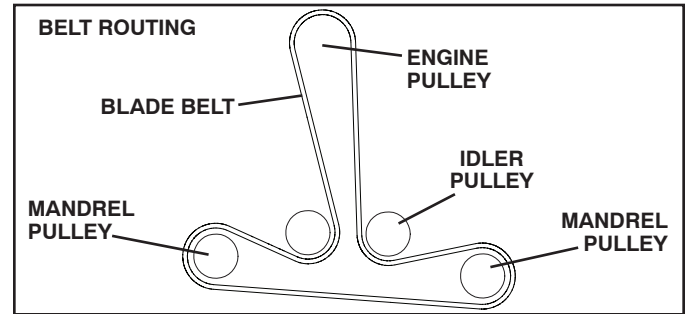

Fig. 12

- Connect spring to eyebolt.
- Install pulley guard and nut previously removed.
- Adjust belt tension until spring is extended to a length of 6.5" (16,5 cm):
  - Loosen inner adjustment nut.
  - Turn outer adjustment nut clockwise (↻) to increase tension, counterclockwise (↺) to decrease tension.
  - Tighten inner adjustment nut securely.

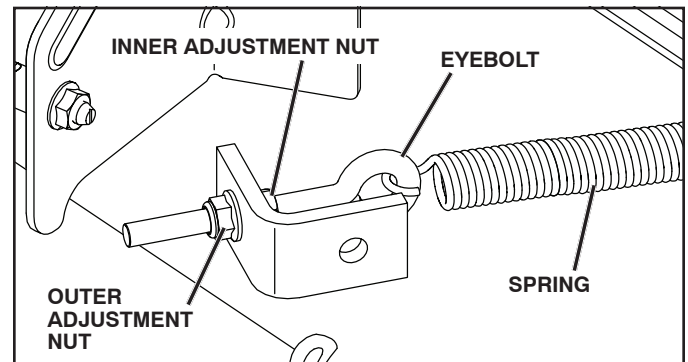
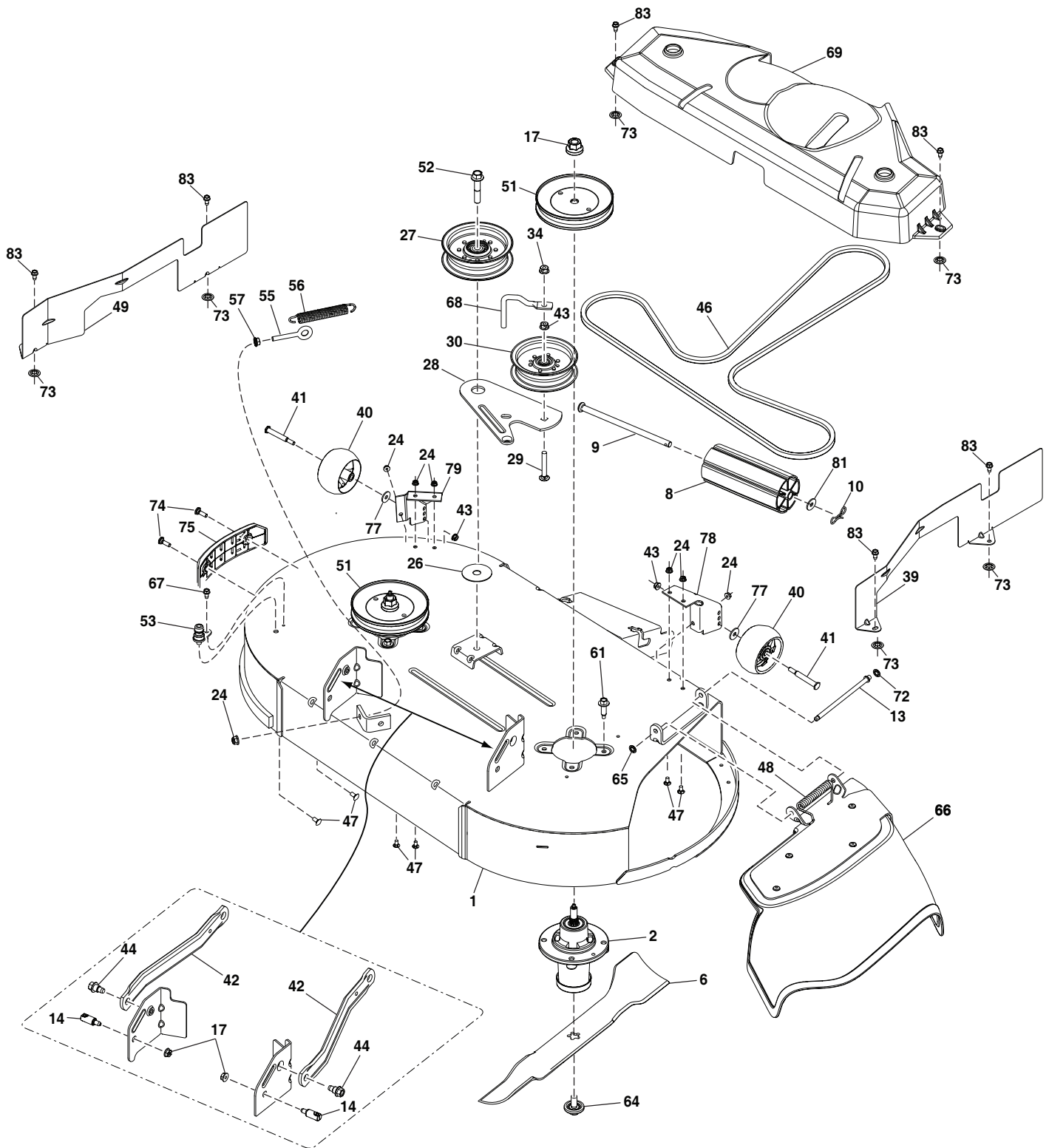

Fig. 13

- Replace mandrel covers on both mandrel housings and secure with fasteners.

# REPAIR PARTS

## 42" REPLACEMENT MOWER DECK PART #597 13 45-01





# REPAIR PARTS

## 42" REPLACEMENT MOWER DECK PART #597 13 45-01

KEY NO.	PART NO.	DESCRIPTION
1	582 87 82-02	Housing, Weldment
2	539 13 18-98	Housing, Assembly
6	592 76 97-08	Blade 42 Clearcut Euro Rev
8	532 17 60-66	Nose Roller
9	532 17 91-27	Rod Roller Nose
10	532 19 42-08	Pin Locking Cotter
13	532 13 14-91	Deflector Hinge Pin
14	532 19 51-61	Stud, Fastening
17	873 90 05-00	Locknut, Hex Flanged
24	539 11 28-99	Nut 5/16-18 Hex Flange
26	532 17 85-15	Washer, Flat Hardened Steel
27	532 19 61-04	Pulley, Idler 4.50
28	586 87 40-02	Arm 42 FCS Clutching
29	539 12 81-01	Bolt RHD 3/8-16 x 2-1/2
30	532 19 61-06	Pulley 4.50 Idler
34	873 68 06-00	Nut Crownlock 3/8-16 unc
39	588 90 75-02	Shield 42 Clearcut RH
40	589 52 73-01	Gauge Wheel
41	532 19 34-06	Bolt Shoulder
42	532 19 51-85	Arm, Suspension RR
43	873 90 06-00	Nut Lock Flg 3/8-15 unc
44	532 19 65-39	Screw, Shoulder
46	501 13 89-01	Belt 42 Clearcut Euro
47	539 99 03-16	RHSNB 5/16 Hx. Whs. Hd. LCKSERR
48	587 35 47-01	Spring, 42 FCS Deflector
49	588 90 74-02	Shield 42 Clearcut LH Deck
51	532 19 74-73	Pulley, Mandrel
52	588 43 83-01	Screw 7/16-14 x 2.125 Hex
53	532 41 55-98	Plate Washout Port
55	539 11 55-74	Bolt Eye 5/16 x 3.50
56	587 35 84-01	Spring, 42 FCS Tractor DK DRV
57	539 99 05-85	Nut 5/16-18 unbc-28 Fln
61	584 95 39-01	Bolt Hex 5/16-18 x 1.310
64	532 19 30-03	Bolt/Washer 7/16-20
65	532 11 04-52	Hinge Pin Push Nut
66	587 30 57-01	Deflector Assembly
67	532 13 77-29	Screw 1/4-20 x 5/8
68	532 19 84-68	Keep Belt
69	588 90 76-01	42 Clearcut Euro Mandrel Cover
72	532 10 53-04	Cap Sleeve
73	532 42 30-62	Palnut 1/4
74	532 17 01-65	Bolt 5/16-18
75	582 68 32-03	Bumper
77	819 12 14-14	Washer 5/16 Flat
78	501 80 83-02	Gauge Wheel Bracket RH
79	590 43 90-02	Gauge Wheel Bracket LH
81	582 36 05-01	Bushing Nose Roller
83	817 49 04-10	Screw 1/4-20 x 5/8 Hx. Self Tap ZD
--	581 58 00-01	Decal, V Belt, Sch.
--	589 35 79-01	Decal, Deck, No Step
--	586 97 88-01	Decal, Deck, Warning
--	597 13 45-01	Deck SVC 42F
--	114 10 59-26	Manual, Deck SVC

**NOTE:** All component dimensions given in U.S. inches  
1 inch = 25.4 mm

---

# SERVICE NOTES

---

---

# SERVICE NOTES

---

