

SimpliCut Li PNC 967986201

EN Operator's manual
Battery Hedge Trimmer

01

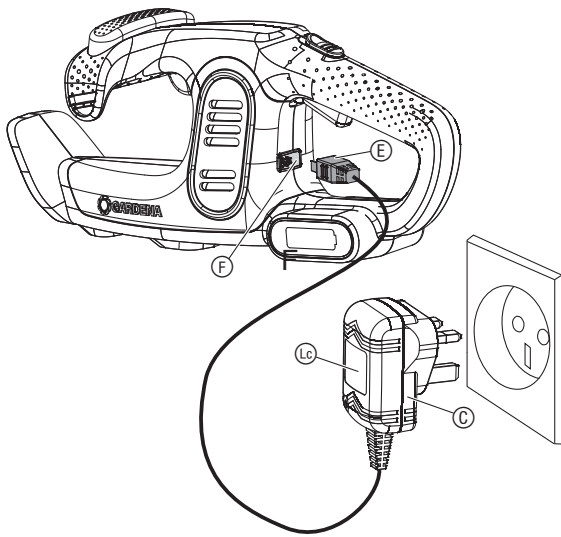

02

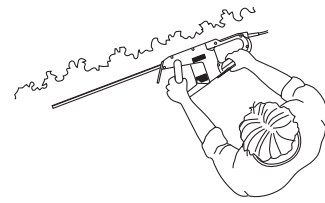

03

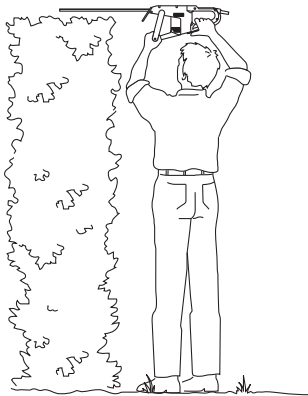

04

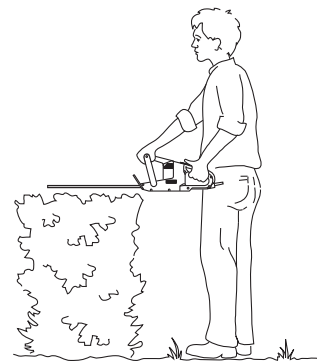

05

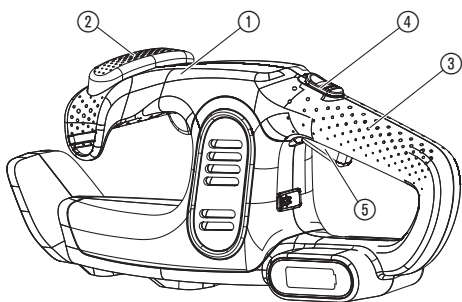

M1

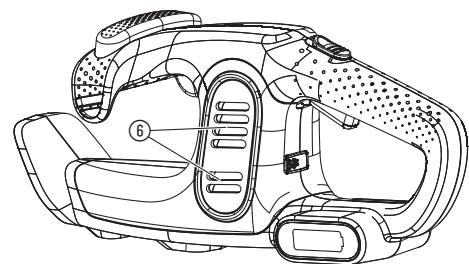

Original instructions.



This product is not intended for use by persons (including children) with reduced physical, sensory or mental capabilities, or lack of experience and knowledge, unless they have been given supervision or instruction concerning use of the product by a person responsible for their safety. Children should be supervised to ensure that they do not play with the product. The use of this product by young people under the age of 16 is not recommended.

Intended use:

The **FLYMO Hedge Trimmer** is intended to cut hedges and shrubs in private domestic gardens and allotments.

The product is not intended for long term use.

DANGER! Risk of injury!

Do not use the product to cut lawns/lawn edges, to chop up material or to make compost.

1. SAFETY

IMPORTANT!

Read the operator's manual carefully before use and keep for future reference.

Symbols on the product:



Read operator's manual.



Always wear approved hearing protection.
Always wear approved eye protection.



Danger – Keep hands away from blade.



Do not expose to rain.



For the charger:
Remove plug from the mains immediately if the cable is damaged or cut.

General safety warnings

General power tool safety warnings:



WARNING!

Read all safety warnings and all instructions! Failure to follow the warnings and instructions may result in electric shock, fire and/or serious injury.

Save all warnings and instructions for future reference.

The term "power tool" in the warnings refers to your mains operated (corded) power tool or battery operated (cordless) power tool.

1) Work area safety

- Keep work area clean and well lit.** Cluttered or dark areas invite accidents.
- Do not operate power tools in explosive atmospheres, such as in the presence of flammable liquids, gases or dust.** Power tools create sparks which may ignite the dust or fumes.
- Keep children and bystanders away while operating a power tool.** Distractions can cause you to lose control.

2) Electrical safety

- Power tool plugs must match the outlet. Never modify the plug in any way. Do not use any adaptor plugs with earthed (grounded) power tools.**
Unmodified plugs and matching outlets will reduce risk of electric shock.
- Avoid body contact with earthed or grounded surfaces, such as pipes, radiators, ranges and refrigerators.** There is an increased risk of electric shock if your body is earthed or grounded.
- Do not expose power tools to rain or wet conditions.**
Water entering a power tool will increase the risk of electric shock.
- Do not abuse the cord. Never use the cord for carrying, pulling or unplugging the power tool. Keep cord away from heat, oil, sharp edges or moving parts.**
Damaged or entangled cords increase the risk of electric shock.
- When operating a power tool outdoors, use an extension cord suitable for outdoor use.**
Use of a cord suitable for outdoor use reduces the risk of electric shock.
- If operating a power tool in a damp location is unavoidable, use a residual current device (RCD) protected supply.**
Use of an RCD reduces the risk of electric shock.

3) Personal safety

- Stay alert, watch what you are doing and use common sense when operating a power tool. Do not use a power tool while you are tired or under the influence of drugs, alcohol or medication.** A moment of inattention while operating power tools may result in serious personal injury.
- Use personal protective equipment. Always wear eye protection.**
Protective equipment such as dust mask, non-skid safety shoes, hard hat, or hearing protection used for appropriate conditions will reduce personal injuries.
- Prevent unintentional starting. Ensure the switch is in the off-position before connecting to power source and/or battery pack, picking up or carrying the tool.** Carrying power tools with your finger on the switch or energising power tools that have the switch on invites accidents.
- Remove any adjusting key or wrench before turning the power tool on.**
A wrench or a key left attached to a rotating part of the power tools may result in personal injury.
- Do not overreach. Keep proper footing and balance at all times.**
This enables better control of the power tool in unexpected situations.
- Dress properly. Do not wear loose clothing or jewellery. Keep your hair, clothing and gloves away from moving parts.**
Loose clothes, jewellery or long hair can be caught in moving parts.
- If devices are provided for the connection of dust extraction and collection facilities, ensure these are connected and properly used.**
Use of dust collection can reduce dust-related hazards.

4) Power tool use and care

- Do not force the power tool. Use the correct power tool for your application.** The correct power tool will do the job better and safer at the rate for which it was designed.
- Do not use the power tool if the switch does not turn it on and off.**
Any power tool that cannot be controlled with the switch is dangerous and must be repaired.
- Disconnect the plug from the power source and /or the battery pack from the power tool before making any adjustments, changing accessories, or storing power tools.** Such preventive safety measures reduce the risk of starting the power tool accidentally.
- Store idle power tools out of the reach of children and do not allow persons unfamiliar with the power tool or these instructions to operate the power tool.**
Power tools are dangerous in the hands of untrained users.
- Maintain power tools. Check for misalignment or binding of moving parts, breakage of parts and any other condition that may affect the power tool's operation. If damaged, have the power tool repaired before use.** Many accidents are caused by poorly maintained power tools.
- Keep cutting tools sharp and clean.** Properly maintained cutting tools with sharp cutting edges are less likely to bind and are easier to control.
- Use the power tool, accessories and tool bits etc. in accordance with these instructions, taking into account the working conditions and the work to be performed.** Use of the power tool for operations different from those intended could result in a hazardous situation.

5) Battery tool use and care

- Recharge only with the charger specified by the manufacturer.**
A charger that is suitable for one type of battery pack may create a risk of fire when used with another battery pack.
- Use power tools only with specifically designated battery packs.**
Use of any other battery packs may create a risk of injury and fire.
- When battery pack is not in use, keep it away from other metal objects, like paper clips, coins, keys, nails, screws or other small metal objects, that can make a connection from one terminal to another.** Shorting the battery terminals together may cause burns or a fire.
- Under abusive conditions, liquid may be ejected from the battery; avoid contact. If contact accidentally occurs, flush with water. If liquid contacts eyes, additionally seek medical help.**
Liquid ejected from the battery may cause irritation or burns.

6) Service

Have your power tool serviced by a qualified repair person using only identical replacement parts.

This will ensure that the safety of the power tool is maintained.

Hedge trimmer safety warnings:

- **Keep all parts of the body away from the cutter blade. Do not remove cut material or hold material to be cut when blades are moving. Make sure the switch is off when clearing jammed material.**
A moment of inattention while operating the hedge trimmer may result in serious personal injury.
- **Carry the hedge trimmer by the handle with the cutter blade stopped. When transporting or storing the hedge trimmer always fit the cutting device cover.** Proper handling of the hedge trimmer will reduce possible personal injury from the cutter blades.
- **Hold the power tool by insulated gripping surfaces only, because the cutter blade may contact hidden wiring or its own cord.** Cutter blades contacting a "live" wire may make exposed metal parts of the power tool "live" and could give the operator an electric shock.
- **Keep cable away from the cutting area.**
During operation the cable may be hidden in shrubs and can be accidentally cut by the blade.

Additional safety warnings

Battery safety



DANGER! Fire risk!

The battery product to be charged must be placed on a non-flammable, heat resistant and non-conductive surface while charging.

Keep corrosive, flammable and easily combustible objects clear of the battery charger and the battery product.

Do not cover the battery charger and the battery product while charging.

Disconnect the battery charger immediately in the event of smoke formation or fire.

Only use the original FLYMO Charger to charge the battery. The use of other battery chargers may damage the batteries irreparably and even cause a fire.

Do not charge any third-party batteries. There is a risk of fire and explosion!

If you notice fire: Extinguish the flames with oxygen reducing materials.



DANGER! Risk of explosion!

Protect battery products from heat and fire. Do not leave on radiators or expose to strong sunshine for long periods.

Do not operate in explosive atmospheres, such as in the presence of flammable liquids, gases, or dust. Battery products may create sparks which could ignite the dust or fumes.

Only charge and use the battery product in ambient temperatures of between 0 °C and 40 °C. Allow battery to cool down after long periods of use.

Check the charging cable regularly for signs of damage or ageing (brittleness). Only use it in perfect condition.

Do not stow or transport the battery product above 45 °C or in direct sunlight. Ideally, the battery product should be stored below 25 °C so that self-discharge is low.

Do not expose the battery product to rain or wet conditions. Water entering a battery product will increase the risk of electric shock.

If usage of the battery is not planned for a certain time (winter period) reload the battery to avoid a deep discharge.

Do not store the battery product in places where static electricity is present.

Electrical safety



DANGER! Cardiac arrest!

This product makes an electromagnetic field while it operates. This field may under some conditions interfere with active or passive medical implants. To decrease the risk of conditions that can possibly injure or kill, we recommend persons with medical implants to speak with their physician and the medical implant manufacturer before you operate the product.

Thoroughly inspect the area where the product is to be used and remove all wires and other foreign objects.

Before using the product and after any impact, check for signs of wear or damage and repair as necessary.

If the product can no longer be switched off in the event of a defect, place the product on a solid surface and monitor it until the battery is empty. Send the defective product to our FLYMO Service Centre.

Never attempt to use an incomplete product or one with an unauthorised modification.

Stop the product if the product starts to vibrate abnormally. Check immediately. Excessive vibration can cause injury.

Do not use the product nearby a water.

Do not operate next to swimming pools or garden ponds.

Personal safety



DANGER! Risk of suffocation!

Small parts can be easily swallowed. There is also a risk that the poly-bag can suffocate toddlers. Keep toddlers away when you assemble the product.



DANGER! Risk of injury!

If the device switches off due to an empty battery (charging control lamp  flashes green), it may happen that the battery recovers after a certain time. The device is then ready for operation again.

Know how to stop the product quickly in an emergency.

Avoid contact to the oil of the blade in particular when you react allergic with it.

Only work in the daylight or when visibility is good.

Check your product before each use. Always visually inspect your Hedge Trimmer before each use. Check that the ventilation slots are not obstructed in any way.

Check the blade before usage.

Keep the blade well maintained.

If the product got hot while operation, let it cool down before storage.

Do not overload the product.

Warning! When wearing hearing protection, and due to the noise produced by the product, the operator may not notice persons approaching.

Always wear suitable clothing, protective gloves, and stout shoes.

Always ensure that you have a secure foothold whilst working.

Do not work on slippery underground.

2. OPERATION



DANGER! Risk of injury!

Cut injury when the product starts accidentally.

→ Wait for the blade to stop and slide the protective cover over the blade before you transport the product.

To charge the battery [Fig. O1]:



CAUTION!

Overvoltage damages the battery and the charging power supply.

→ Make sure that you use the correct mains voltage.

Before you use the battery the first time, the battery must be completely charged.

The lithium-ion battery can be charged in any state of charge and the charging process can be disconnected at any time without to damage the battery (no memory effect).

1. Connect the charging power supply  into a mains socket.

The power LED  illuminates red.



2. Connect the battery charger cable  to the charging socket .

When the charging control lamp  at the charging socket flashes green, the battery is being charged.

When the charging control lamp  at the charging socket illuminates green, the battery is completely charged

(Charging time, see 6. TECHNICAL DATA).

3. Examine the charge status regularly while you charge.

4. When the battery is completely charged, disconnect the battery charger cable  from the charging socket .

5. Disconnect the charging power supply  from the mains.

Work positions:

The hedge trimmer can be operated in 3 positions.

– Side trimming [Fig. O2]

– High trimming [Fig. O3]

– Low trimming [Fig. O4]

To start the hedge trimmer [Fig. O5]:



DANGER! Risk of injury!



Risk of injury if the product does not stop when you release the start levers.



→ Do not bypass the safety devices or switches. For example do not attach the start levers to the handle.

To start:

The product is provided with a two-handed safety device (2 start levers with starting lockout) to prevent the product from being turned on by accident.

1. Remove the protective cover from the blade.

2. Hold the front handle  with one hand and push the front start lever .

3. Hold the main handle  with the other hand, push the starting lockout  forward and pull the rear start lever .

The hedge trimmer starts.

4. Release the starting lockout  again.

To stop:

1. Release the two start levers /.

The hedge trimmer stops.

2. Wait for the blade to stop and slide the protective cover over the blade.

3. MAINTENANCE



DANGER! Risk of injury!

Cut injury when the product starts accidentally.

→ Wait for the blade to stop and slide the protective cover over the blade before you maintain the product.

To clean the Hedge Trimmer [Fig. M1]:



DANGER! Risk of injury!

Risk of injury and risk of damage to the product.

→ Do not clean the product with water or with a water jet (in particular high-pressure water jet).

→ Do not clean with chemicals including petrol or solvents. Some can destroy critical plastic parts.

The airflow slots must always be clean.

1. Clean the product with a damp cloth.
2. Clean the airflow slots (Ⓒ) with a soft brush (do not use a screwdriver).

To clean the charging power supply:

Make sure that the contacts of the charging socket and the charging power supply always are clean and dry before you connect the charging power supply.

Do not use running water.

→ Clean the contacts and the plastic parts with a soft and dry cloth.

4. STORAGE

To put into storage:

The product must be stored away from children.

1. Charge the battery.
2. Clean the hedge trimmer and the charging power supply (see 3. MAINTENANCE).
3. Store the hedge trimmer and the charging power supply in a dry, enclosed and frost-free place.

Disposal:

(in accordance with RL2012/19/EC)

The product must not be disposed of to normal household waste. It must be disposed of in line with local environmental regulations.

The FLYMO battery contains lithium-ion cells that should not be disposed of with normal household waste at the end of its life.



IMPORTANT!

→ Dispose of the product through or via your municipal recycling collection centre.

5. TROUBLESHOOTING



DANGER! Risk of injury!

Cut injury when the product starts accidentally.

→ Wait for the blade to stop and slide the protective cover over the blade before you troubleshoot the product.

Problem	Possible Cause	Remedy
Hedge is not cleanly cut	Blade is blunt or damaged.	→ Get the blade sharpened by a professional.
Hedge trimmer does not start. Charging control lamp (Ⓒ) flashes green	Under voltage.	→ Charge the battery.
Hedge trimmer does not start. Charging control lamp (Ⓒ) flashes red	Battery overload.	→ Release the start levers. Start again.
	Blade is blocked.	→ Remove the obstacle. Start again.
Hedge trimmer does not start. Charging control lamp (Ⓒ) flashes red	Battery temperature is out of range.	→ Use the battery in surroundings where temperatures are between 0 °C and 40 °C.

Problem	Possible Cause	Remedy
Power LED (Ⓒ) on the charging power supply does not illuminate	Charging power supply is not plugged in correctly.	→ Plug the charging power supply into a wall outlet.



NOTE: For any other malfunctions please contact the FLYMO service department. Repairs must only be done by FLYMO service departments or specialist dealers approved by FLYMO.

6. TECHNICAL DATA

Battery Hedge Trimmer	Unit	Value (PNC 967986201)
Strokes	1/min	2400
Length of blade	cm	40
Tooth gap of blade	mm	16
Weight	kg	2.2
Sound pressure level L_{pA} ¹⁾ Uncertainty k_{pA}	dB(A)	75 3
Sound power level L_{WA} ²⁾ : measured/guaranteed Uncertainty k_{WA}	dB(A)	85 / 91 6
Hand/arm vibration a_{whv} ¹⁾ Uncertainty k_a	m/s ²	< 2.5 1.5

Measuring process complying with: ¹⁾ EN 60745-2-15 ²⁾ RL 2000/14/EC



NOTE: The stated vibration emission value has been measured according to a standardized test procedure and can be used for comparison of one electric power tool with another. It can also be used for preliminary evaluation of exposure. The vibration emission value can vary during actual use of the electric power tool.

Battery	Unit	Value
Battery voltage	V (DC)	14.4
Battery capacity	Ah	2.0
Battery charging time 80 % / 100 % (approx.)	min.	160 / 200
Charging Power Supply	Unit	Value (PNC 598446701)
Mains voltage	V (AC)	100 – 240
Mains frequency	Hz	50 – 60
Rated Power	W	15
Output voltage	V (DC)	18.5
Max. output current	mA	600

7. ACCESSORIES

FLYMO Charging Power Supply	Charger to charge the internal batteries.	PNC 598446701
-----------------------------	-------------------------------------------	----------------------

8. SERVICE/WARRANTY

Service:

Please contact the address on the back page.

Warranty statement:

In the event of a warranty claim, no charge is levied to you for the services provided.

Husqvarna UK Ltd. grants a warranty for all original FLYMO new products for two years from the date of original purchase from the retailer, provided that the devices have been for private use only. This manufacturer's warranty does not apply to products acquired second hand. This warranty includes all significant defects of the product that can be proved to be material or manufacturing faults. This warranty is fulfilled by supplying a fully functional replacement product or by repairing the faulty product sent to us free of charge; we reserve the right to choose between these options. This service is subject to the following provisions:

- The product has been used for its intended purpose as per the recommendations in the operating instructions.
- Neither the purchaser nor a third party has attempted to open or repair the product.

- Only Original FLYMO replacement parts and wear parts have been used for operation.
- Presentation of the receipt.

Normal wear and tear of parts and components (such as blades, blade fixing parts, turbines, light bulbs, V-belts/toothed belts, impellers, air filters, spark plugs), visual changes, wear parts and consumables are excluded from the warranty.

This manufacturer's warranty is limited to replacement and repair of products in accordance with the abovementioned conditions. The manufacturer's warranty does not constitute an entitlement to lodge other claims against us as a manufacturer, such as for damages. This manufacturer's warranty does **not**, of course, affect statutory and contractual warranty claims against the dealer/retailer.

The manufacturer's warranty is governed by the law of the Federal Republic of Germany.

In case of a warranty claim, please return the faulty product, together with a copy of the receipt and a description of the fault, with postage paid to the service address.

Consumables:

The blade and excentric drive are consumables and are not included in the warranty.

PRODUCT LIABILITY

In accordance with the German Product Liability Act, we hereby expressly declare that we accept no liability for damage incurred from our products where said products have not been properly repaired by a FLYMO-approved service partner or where original FLYMO parts or parts authorised by FLYMO were not used.

EC DECLARATION OF CONFORMITY

The undersigned hereby certifies as the authorized representative of the manufacturer, Husqvarna AB, 561 82 Huskvarna, Sweden, that, when leaving our factory, the unit(s) indicated below is/are in accordance with the harmonised EU guidelines, EU standards of safety and product specific standards. This certificate becomes void if the unit(s) is/are modified without our approval.

Description of the product:	Hedge Trimmer
Product type	SimpliCut Li
Article-Number	9679862-01
CE-Directives	2006/42/EC 2014/30/EU 2011/65/EU 2000/14/EC 2014/35/EU
Harmonised EN	EN ISO 12100 EN 60745-1 EN 60745-2-15 EN 61558-1 EN 61558-2-16
Deposited Documentation	GARDENA Technical Documentation, M. Kugler, 89079 Ulm
Conformity Assessment according to	2000/14/EC Procedure: art. 14 Annex V
Year of CE marking:	2019
Noise level: measured / guaranteed	85 dB (A)/91 dB (A)
Ulm, 29.10.2019	
Authorised representative:	 John Thompson Product and Marketing Director EUAP

Great Britain

Husqvarna UK Ltd
Preston Road
Aycliffe Industrial Park
Newton Aycliffe
County Durham
DL5 6UP
Phone: +44 (0) 344 8444558
customer.services@husqvarna.co.uk

Our policy of continuous improvement means that the specification of products may be altered from time to time without prior notice.

Copyright © 2015 Flymo S.A. All rights reserved.

Flymo® and other product and feature names are registered or unregistered trademarks of Flymo S.A.



F9836-20.960.01/1019
Husqvarna AB
S-561 82 Huskvarna
Sweden