



Art. 19032

EN **Operator's manual**  
**smart** Irrigation Control

---

# GARDENA smart Irrigation Control 24 V

---

|                            |    |
|----------------------------|----|
| 1. SAFETY .....            | 4  |
| 2. ASSEMBLY .....          | 6  |
| 3. INSTALLATION .....      | 8  |
| 4. OPERATION .....         | 19 |
| 5. MAINTENANCE .....       | 22 |
| 6. STORAGE .....           | 22 |
| 7. TROUBLESHOOTING .....   | 23 |
| 8. TECHNICAL DATA .....    | 25 |
| 9. ACCESSORIES .....       | 26 |
| 10. SERVICE/WARRANTY ..... | 27 |

## Original instructions.



For safety reasons, children and young people under 16 as well as anyone who is not familiar with these operating instructions should not use the product. Persons with reduced physical or mental abilities may use the product only if they are supervised or instructed by a responsible person. Children must be supervised to ensure that they do not play with the product. Never operate the product when you are tired, ill or under the influence of alcohol, drugs or medicine.

### ***Intended use:***

The **GARDENA smart Irrigation Control** is intended for private use in domestic and hobby gardens, to control sprinklers and watering systems. It can be used for automatic watering during holidays. It is only intended for use in a weatherproof and dust-proof location. It is not intended for indoor use.

The **GARDENA smart Irrigation Control** is part of a garden irrigation system and can only be programmed together with the **GARDENA smart Gateway**.

The **GARDENA smart Irrigation Control** is configured via the **GARDENA smart system App** and controls the watering. Sprinklers, a sprinkler system or a drip head watering system can be used for watering.

The **GARDENA smart Irrigation Control** carries out watering fully automatically according to the set program and can therefore also be used during holidays.



### **DANGER! Risk of injury!**

**The product must not be used for industrial purposes or in conjunction with chemicals, foodstuffs, easily flammable and explosive materials.**

# 1. SAFETY

## Important!

Read the operator's manual carefully before use and keep for future reference.

## Symbols on the product:



Read operator's manual.

## Electrical safety



**DANGER! Cardiac arrest!**

This product makes an electromagnetic field while it operates. This field may under some conditions interfere with active or passive medical implants. To decrease the risk of conditions that can possibly injure or kill, we recommend persons with medical implants to speak with their physician and the medical implant manufacturer before you operate the product.



**DANGER!  
Electric shock!**

**Risk of injury due to electric shock.**

- The product must be supplied through a residual current device (RCD) having a rated residual operating current not exceeding 30 mA.



**CAUTION!**

**Only plug the transformer into the power outlet in a vertical position.**

The product must only be operated with the 24 V (AC) power supply unit provided. Do not use an adapter.

Protect the 24 V (AC) power supply unit from moisture and direct sunlight when connected.

Install the irrigation control in a weatherproof location.

Check the power cord for damage before use.

The product must be used only for controlling commercially available 24 V (AC) valves. The electric power consumption per channel must not exceed 400 mA (a GARDENA Irrigation Valve Art. 1278 requires 150 mA).

## **Cable cross-section of the connection cable:**

The maximum permissible distance between the product and the valve depends on the cross-section of the connection cable. For a distance of 30 m, the cross section is 0.5 mm<sup>2</sup> and 0.75 mm<sup>2</sup> for a distance of 45 m. No more than 3 valves must be in operation at the same time. The **GARDENA Connection Cable Art. 1280** is 0.5 mm<sup>2</sup> in size and is 15 m long.

Up to 6 valves can be connected using this cable. The connection cable can be connected so that it is watertight using the **GARDENA Cable Clip Art. 1282**.

### ***Personal safety***



**DANGER!**  
**Risk of suffocation!**

**Small parts can be easily swallowed. There is also a risk that the polybag can suffocate toddlers. Keep toddlers away when you assemble the product.**

Protect the product from direct sunlight.



**Be careful when touching the valves!**

**Metal parts can heat up.**

## 2. ASSEMBLY

---

### ***To assemble the irrigation control on the wall:***

The both screws and dowels are in the scope of delivery.

The distance between the holes is 120 mm.

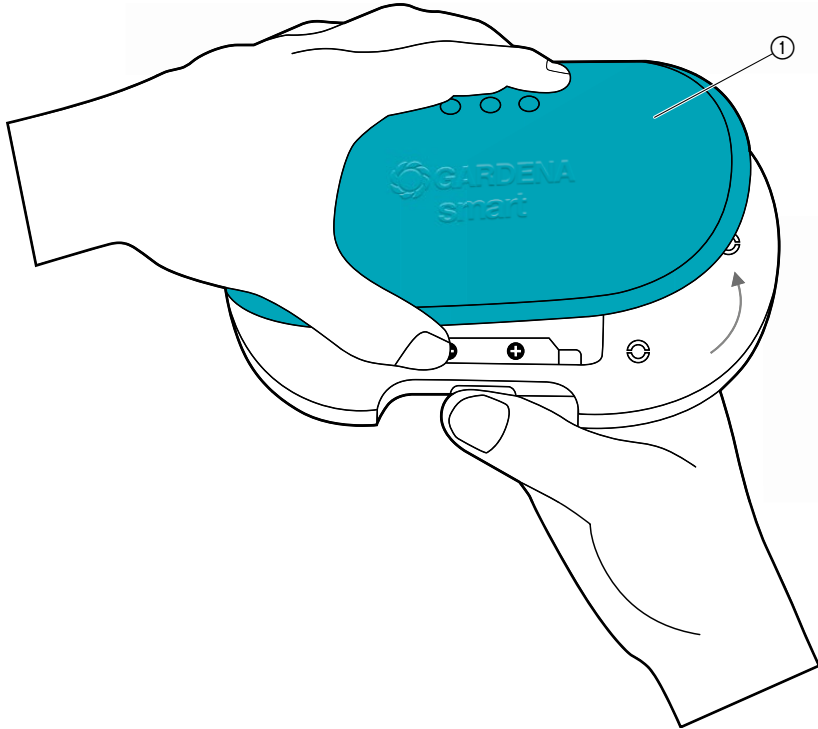

1. Remove the cover ①.

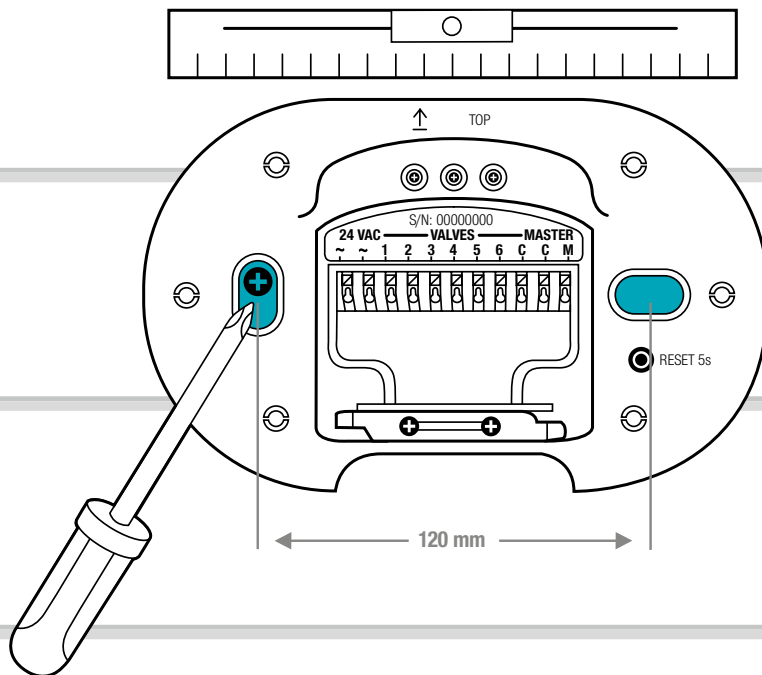

2. Mark the positions of the holes. To do this, hold the Irrigation Control against the wall, bring it straight and mark 2 holes at a distance of 120 mm.
3. Drill the holes and assemble the Irrigation Control to the wall with the 2 plugs and screws supplied.

#### **NOTE:**

#### **The cables must be led downwards!**

Pay attention to the cable lengths, especially during initial installation.

If you want to mount several irrigation controls, the distance between the holes is 150 mm.

Due to the cable routing, up to 3 Irrigation Controls can be assembled on top of each other.

### 3. INSTALLATION

**To remove the cable strain relief:**

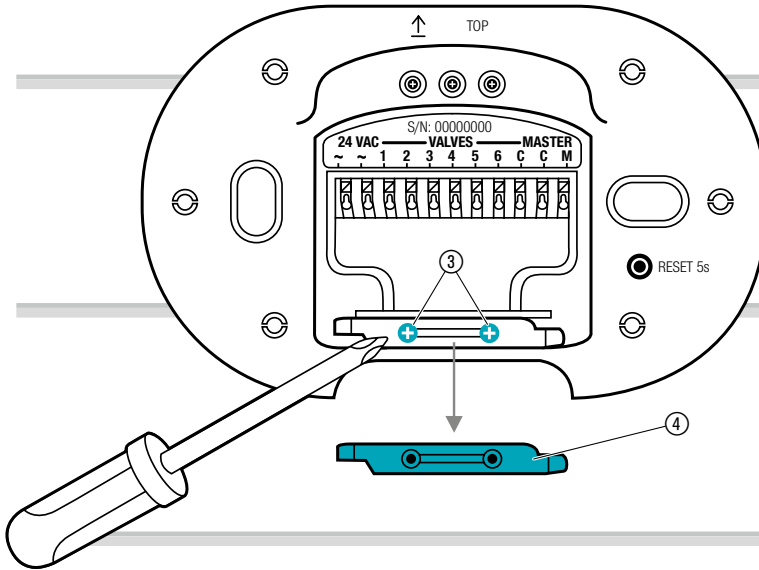

→ Loosen both screws ③ and remove the cable strain relief ④.



## Connection overview:

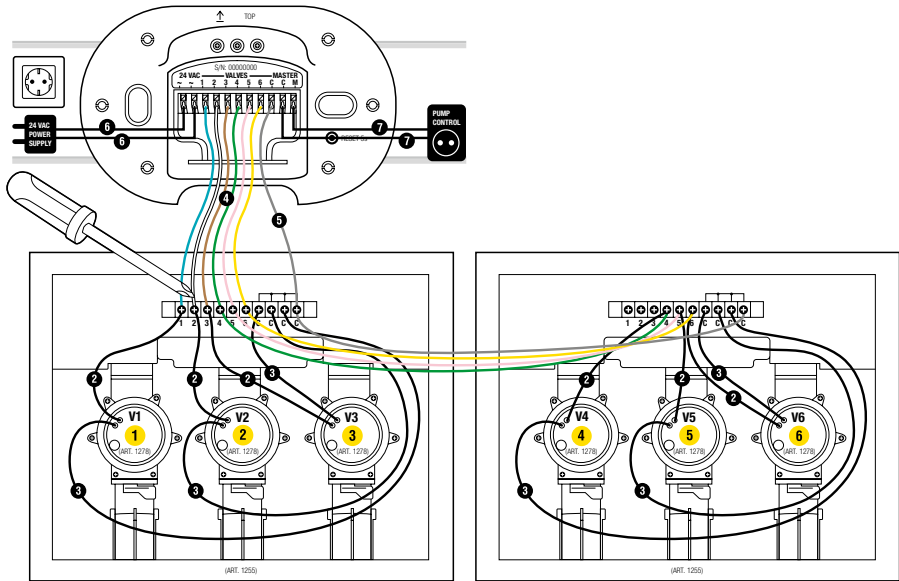

**Valve Box Art. 1255**

**Valve Box Art. 1255**

## To connect the valves to the Valve Box:

Make sure that the terminal block has been correctly installed in the valve box.

1

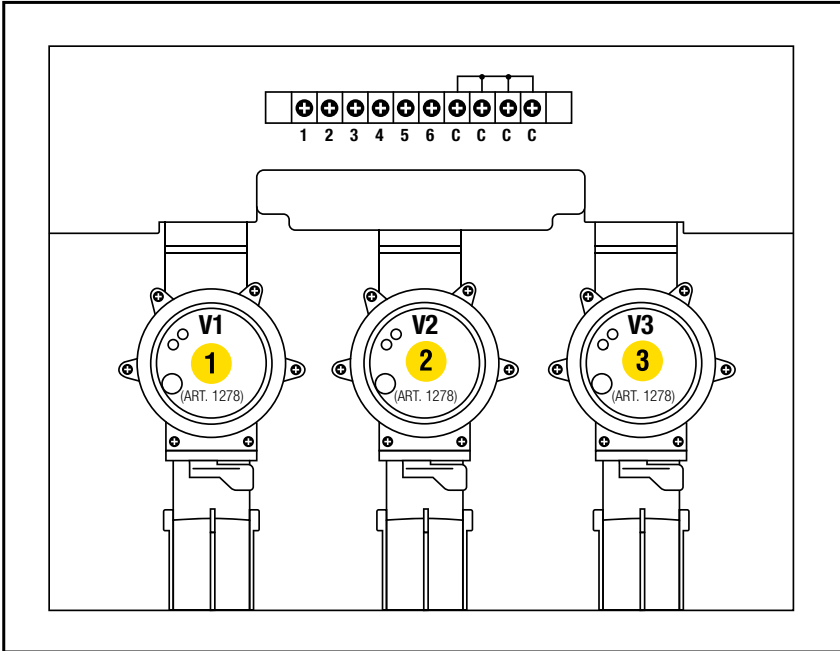

→ Label the valves (1 – 6) with the yellow stickers of the valve box.  
*(Therefore the signal cable terminals **VALVES 1 – 6** of the Irrigation Control can be clearly assigned to the valves).*

2

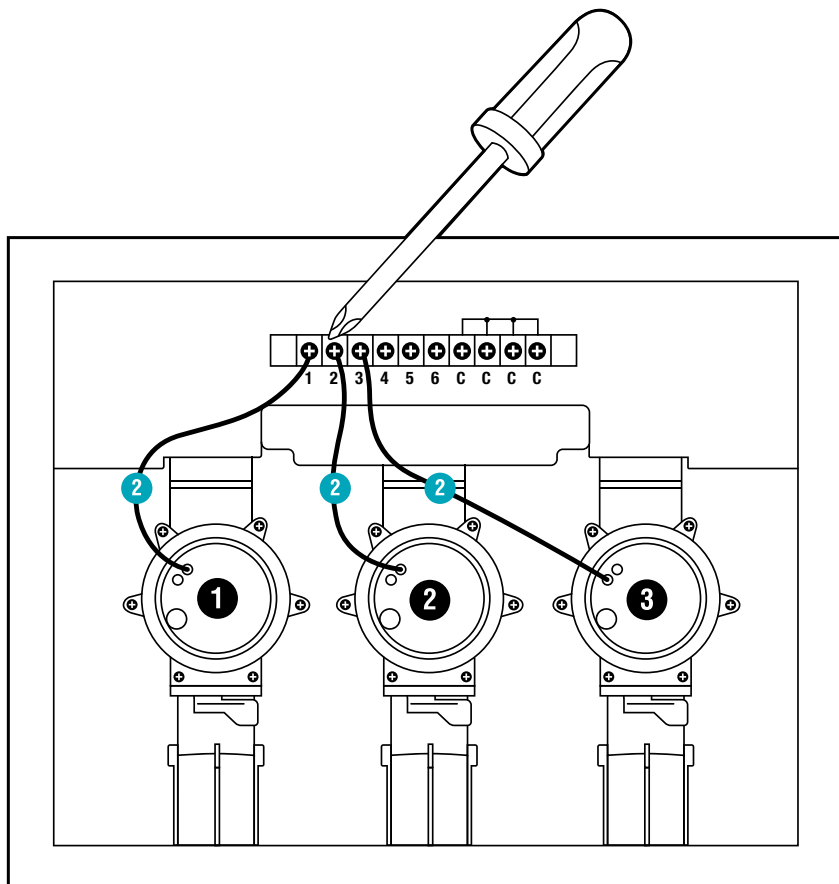

- Connect a cable of the valve **V1** to the signal cable terminal **1** of the Valve Box.
- Connect a cable of the valve **V2** to the signal cable terminal **2** of the Valve Box.
- Connect a cable of the valve **V3** to the signal cable terminal **4** of the Valve Box.

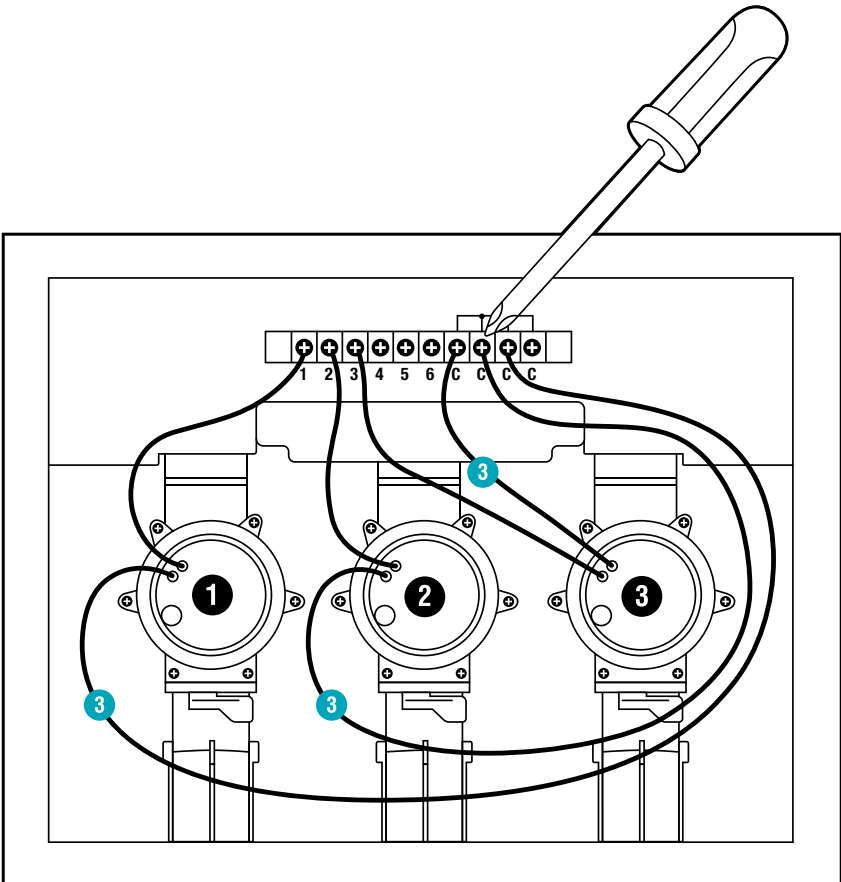

- Connect the other cable of the valve **V1** to a signal cable terminal **C** of the Valve Box.  
*(All 4 signal cable terminals **C** are connected to each other and equivalent).*
- Connect the other cable of the valve **V2** to a signal cable terminal **C** of the Valve Box.
- Connect the other cable of the valve **V3** to a signal cable terminal **C** of the Valve Box.

## To connect the Valve Box to the Irrigation Control:

**Tip:** Press down the signal cable terminal with your index finger, screwdriver or ballpoint pen to connect the cables.

With the **GARDENA Connection Cable Art. 1280** you can connect up to **6 valves** with the Irrigation Control.

4

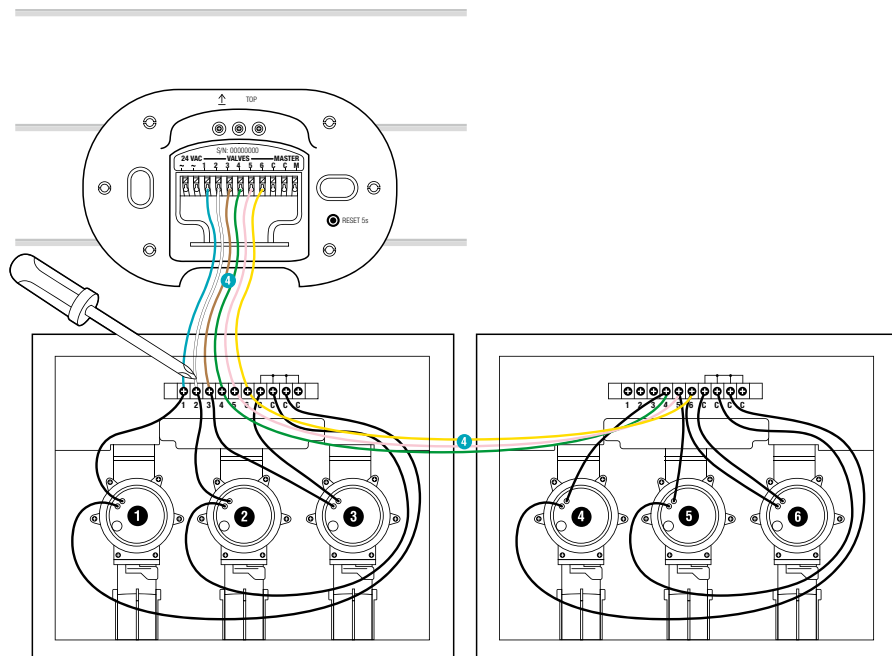

- Connect the signal cable terminal **1** of the Valve Box to the signal cable terminal **VALVES 1** of the Irrigation Control.
- Connect the signal cable terminal **2** of the Valve Box to the signal cable terminal **VALVES 2** of the Irrigation Control.
- Connect the signal cable terminal **3** of the Valve Box to the signal cable terminal **VALVES 3** of the Irrigation Control.

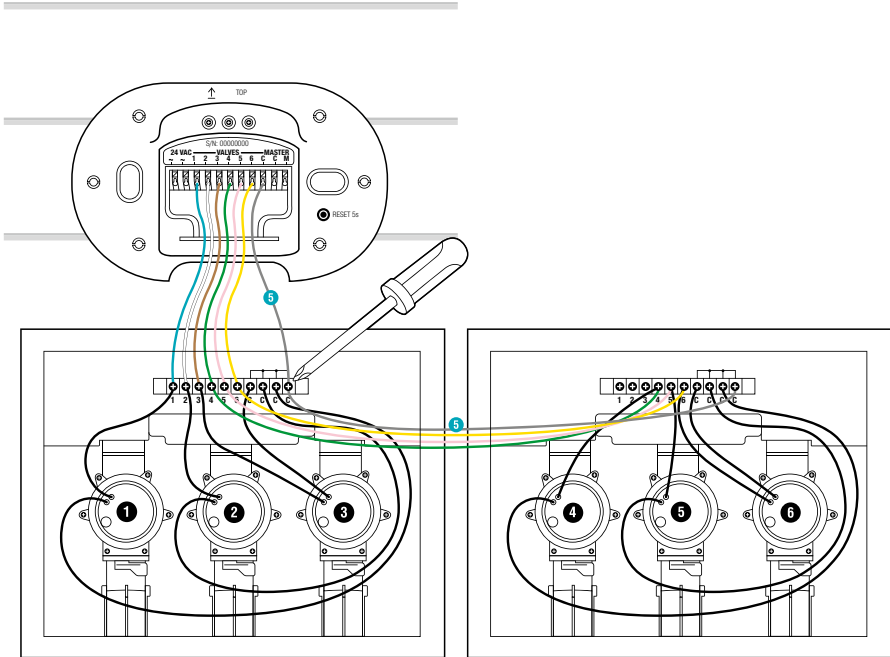

→ Connect one signal cable terminal **C** of the Valve Box to the blue signal signal cable terminal **C** of the Irrigation Control.

## To connect the pump:

### Master Channel:

The master channel **M** is activated as soon as a valve is activated.

For example, you can activate a garden pump via the master channel so that the pump supplies the irrigation system whenever a valve is activated.

6

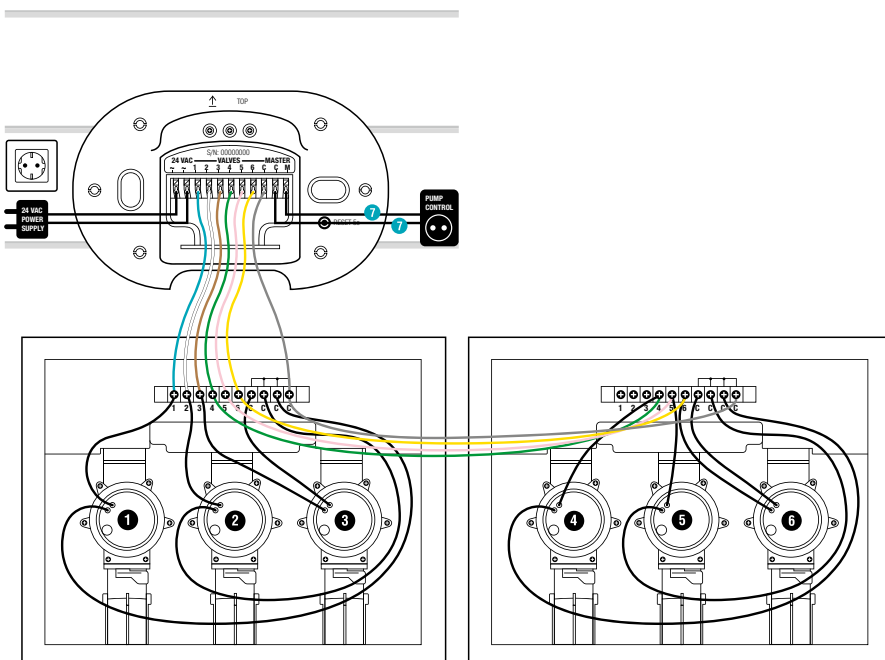

→ Connect both cables to the signal cable terminals **M** and **C** of the Irrigation Control (polarity does not have to be considered).

## ***To connect the power supply:***



### **CAUTION!**

**The irrigation control is damaged if the power supply unit is connected to cable terminals other than the 24 V (AC) cable terminals!**

**→ Connect the power supply unit to the 24 V (AC) terminals only!**



### **CAUTION!**

**Damaging of the irrigation control system by short circuit!**

**→ Check all wiring before you plug in the power supply.**



7

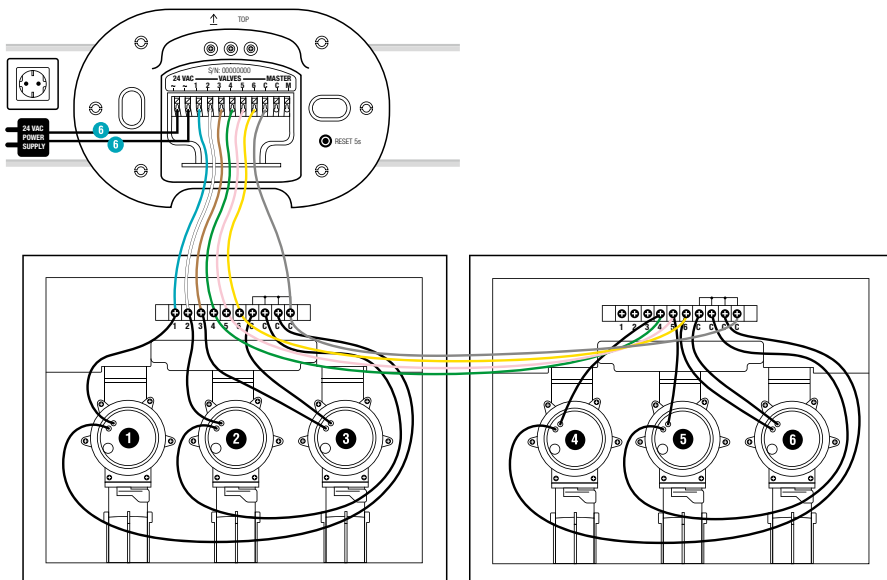

1. Connect both cables to the cable terminals **24 V (AC)** of the Irrigation Control (polarity does not have to be considered).
2. Plug the power supply unit into an socket.

## To close the cover:

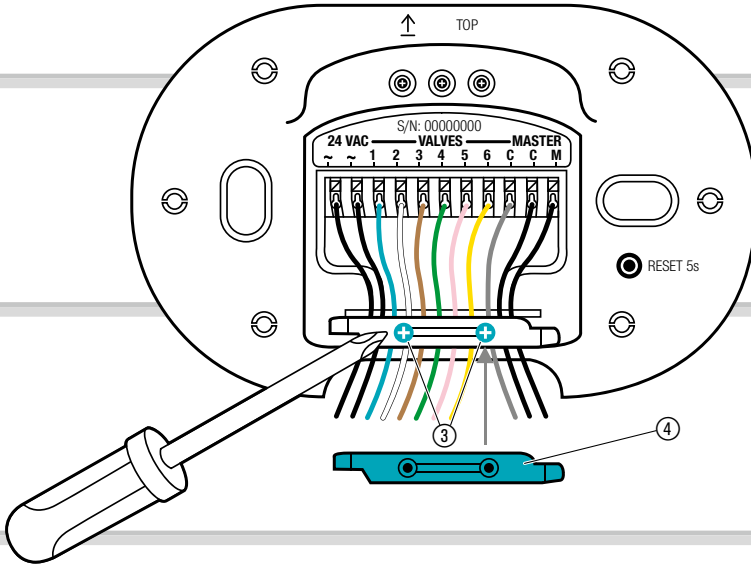

1. Attach the cable strain relief ④ and tighten the two screws ③.

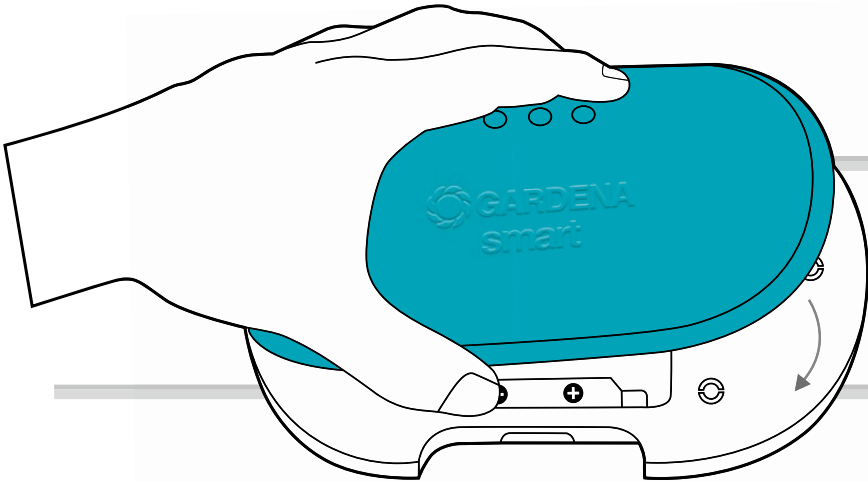

2. Push the cover onto the Irrigation Control.

## 4. OPERATION

---

### LED Display:

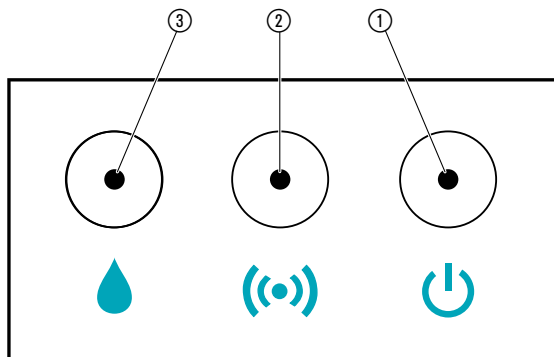

- ① **LED Power:**  
**Green:** Power On
- ② **LED Connection display/Signal:**  
**Green flashing:** While connecting  
**Green:** Signal strength high  
**Yellow:** Signal strength medium  
**Red:** Signal strength low  
**Red flashing:** Inclusion mode failed
- ③ **LED Active watering:**  
**Green:** Active watering  
**Red flashing:** Valve error (see 7. TROUBLESHOOTING)

## ***Operation with the GARDENA smart system App:***

You can use the **GARDENA smart system app** to control all smart system products from anywhere at any time. You can download the free **GARDENA smart system app** from the Apple App Store or from the Google Play Store.

In order to include, a **GARDENA smart Gateway** with internet connectivity is needed. All GARDENA smart products are integrated via the app. Follow the instructions inside the App.

## ***Settings of the Irrigation Control:***

- According to the timings in the smart system App:  
Watering days, start, duration
- As required in the smart system App:  
Start and finish

## Factory Reset:

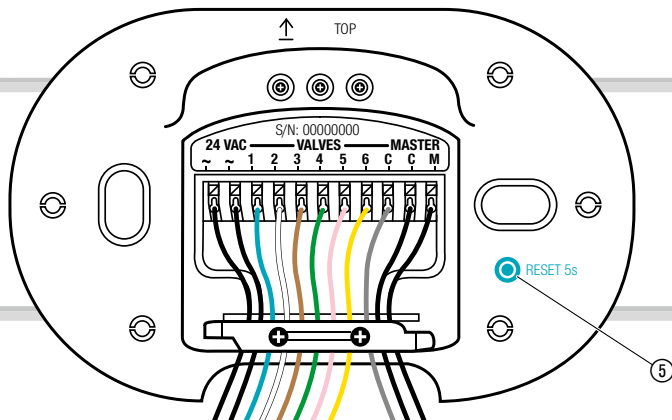

The smart Irrigation Control will be reset to the factory settings.

→ Push the Reset key ⑤ for a short time.  
*New connection.*

**- or -**

→ Push and hold down the Reset key ⑤ for at least 5 seconds.  
 *Cancels the existing connection and allows a new connection to be established, e. g. different Gateway.*

## 5. MAINTENANCE

---

### ***To clean the Irrigation Control:***

Do not use caustic / abrasive cleaning agents.

→ Clean the Irrigation Control with a damp cloth (do not use solvent).

## 6. STORAGE

---

### ***To put into storage:***

The product must be stored away from children.

→ Do not store the Irrigation Control outdoors if not in use.

### ***Disposal:***

*(in accordance with RL2012/19/EC)*





The product must not be disposed of to normal household waste. It must be disposed of in line with local environmental regulations.

### **IMPORTANT!**

Dispose of the product through or via your municipal recycling collection centre.

## 7. TROUBLESHOOTING

| Problem  | Possible Cause                                 | Remedy  |
|--|--|---|
|  <b>LED Power illuminates red</b>       | Undervoltage                                   | → Check the power connection.   |
|  | Wrong power supply.                            | → Check the power supply.   |
|  | MCU Communication error.                       | → Reset the irrigation control to factory settings.   |
|  <b>LED Active Watering flashes red</b> | Can't open valve because of limit of 2.        | → Check the program.  |
|  | Valve is not connected.                        | → Check the valve.  |
|  | Single channel overcurrent.                    | → Check the current of the channel.   |
|  | Sum overcurrent.                               | → Check the sum current of the valves.  |
|  | Watering schedule cancelled.                   | → Restart the program.  |
|  | Master channel error                           | → Check the master channel.   |
|  | Watering duration too short.                   | → Increase the watering duration  |
| <b>Watering program is not being undertaken (no watering)</b>  | The valve has previously been manually opened. | → Avoid any program overlap.  |
|  | Water tap closed.                              | → Open the water tap.   |
| <b>No function</b>   | Faulty wiring.                                 | → Check the cable terminals.  |
|  | Power supply unit is not connected.            | → Connect the power supply unit.  |
|  | Power supply unit is too hot.                  | → Disconnect the power supply unit and let it be cooled down. Connect the power supply unit again.<br>→ Protect the power supply unit from direct sunlight. |
| <b>Inclusion is not possible (Inclusion)</b>   | No wireless connection to the Gateway.         | → Select another position for the irrigation control or the Gateway.  |
|  | No power supply available.                     | → Check the mains cable.  |

| <b>Problem</b>                             | <b>Possible Cause</b>                  | <b>Remedy</b>                                   |
|--|--|---|
| <b>Irrigation Control does not respond</b> | Faulty wiring.                         | → Check the cable terminals.                    |
|  | No wireless connection to the Gateway. | → Check the wireless connection to the Gateway. |



**NOTE: For any other malfunctions please contact the GARDENA service department. Repairs must only be done by GARDENA service departments or specialist dealers approved by GARDENA.**



## 8. TECHNICAL DATA

|   | Unit   | Value (Art. 19032) |
|---|--------|--------------------|
| <b>Operation temperature range (outdoors)</b> | °C     | +5 – +40           |
| <b><i>SRD:</i></b>                            |        |                    |
| <b>Frequency range</b>                        | MHz    | 863 – 870          |
| <b>Maximum power</b>                          | mW     | 25                 |
| <b>Free field radio range (approx.)</b>       | m      | 100                |
| <b><i>Power supply</i></b>                    |        |                    |
| <b>Mains voltage</b>                          | V (AC) | 230 – 240          |
| <b>Mains frequency</b>                        | Hz     | 50                 |
| <b>Rated Power</b>                            | W      | 22                 |
| <b>Standby power (approx.)</b>                | W      | 3                  |
| <b>Output voltage</b>                         | V (AC) | 24                 |
| <b>Max. Output current</b>                    | mA     | 600                |

### ***EC Declaration of Conformity:***

Hereby, GARDENA Manufacturing GmbH declares that the radio equipment type (Art. 19032) is in compliance with directive 2014/53/EU.

The full text of the EC declaration of conformity is available at the following internet address:

**<http://www.gardena.com/int/support/safety-regulations>**

## 9. ACCESSORIES

---

**GARDENA smart Sensor**

**Art. 19030**

---

**GARDENA Watering Valve 24V**

**Art. 1278**

---

**GARDENA Valve Boxes**

**Art. 1254/1255**

---

**GARDENA Connection Cable**

**Art. 1280**

---

**GARDENA Cable Clips**

**Art. 1282**

## 10. SERVICE/WARRANTY

---

### **Service:**

Please contact the address on the back page.

### **Warranty statement:**

In the event of a warranty claim, no charge is levied to you for the services provided.

GARDENA Manufacturing GmbH grants a warranty for all original GARDENA new products for two years from the date of original purchase from the retailer, provided that the devices have been for private use only. This manufacturer's warranty does not apply to products acquired second hand. This warranty includes all significant defects of the product that can be proved to be material or manufacturing faults. This warranty is fulfilled by supplying a fully functional replacement product or by repairing the faulty product sent to us free of charge; we reserve the right to choose between these options. This service is subject to the following provisions:

- The product has been used for its intended purpose as per the recommendations in the operating instructions.
- Neither the purchaser nor a third party has attempted to open or repair the product.
- Only Original GARDENA replacement parts and wear parts have been used for operation.
- Presentation of the receipt.

Normal wear and tear of parts and components (such as blades, blade fixing parts, turbines, light bulbs, V-belts/toothed belts, impellers, air filters, spark plugs), visual changes, wear parts and consumables are excluded from the warranty.

This manufacturer's warranty is limited to replacement and repair of products in accordance with the abovementioned conditions. The manufacturer's warranty does not constitute an entitlement to lodge other claims against us as a manufacturer, such as for damages. This manufacturer's warranty does **not**, of course, affect statutory and contractual warranty claims against the dealer/retailer.

The manufacturer's warranty is governed by the law of the Federal Republic of Germany.

In case of a warranty claim, please return the faulty product, together with a copy of the receipt and a description of the fault, with postage paid to the service address.

***Product liability:***

In accordance with the German Product Liability Act, we hereby expressly declare that we accept no liability for damage incurred from our products where said products have not been properly repaired by a GARDENA approved service partner or where original GARDENA parts or parts authorised by GARDENA were not used.

**Deutschland / Germany**

**GARDENA**  
Manufacturing GmbH  
Central Service  
Hans-Lorenser-Straße 40  
D-89079 Ulm  
Produktfragen:  
(+49) 731 490-123  
Reparaturen:  
(+49) 731 490-290  
service@gardena.com

**Albania**

**COBALT** Sh.p.k.  
Rr. Siri Kodra  
1000 Tirana

**Argentina**

Husqvarna Argentina S.A.  
Av.del Libertador 5954 –  
Piso 11 – Torre B  
(C1428ARP) Buenos Aires  
Phone: (+54) 11 5194 5000  
info.gardena@  
ar.husqvarna.com

**Armenia**

Garden Land Ltd.  
61 Tigran Mets  
0005 Yerevan

**Australia**

Husqvarna Australia Pty. Ltd.  
Locked Bag 5  
Central Coast BC  
NSW 2252  
Phone: (+61) (0) 2 4352 7400  
customer.service@  
husqvarna.com.au

**Austria / Österreich**

Husqvarna Austria GmbH  
Industriezeile 36  
4010 Linz  
Tel.: (+43) 732 77 01 01-485  
service.gardena@  
husqvarnagroup.com

**Azerbaijan**

Firm Progress  
a. Aliyev Str. 26A  
1052 Bakı

**Belgium**

Husqvarna België nv/sa  
Gardena Division  
Rue Egide Van Ophem 111  
1180 Uccle / Ukkel  
Tel.: (+32) 2 720 92 12  
info@gardena.be

**Bosnia / Herzegovina**

**SILK TRADE** d.o.o.  
Industrijska zona Bukva bb  
74260 Tešanj

**Brazil**

Husqvarna do Brasil Ltda  
Av. Francisco Matarazzo,  
1400 – 19º andar  
São Paulo – SP  
CEP: 05001-903  
Tel: 0800-112252  
marketing.br.husqvarna@  
husqvarna.com.br

**Bulgaria**

**AGROLAND** България АД  
бул. 8 Декември, №13  
Офис 5  
1700 Студентски град  
София  
Тел.: (+359) 246669 10  
info@agroland.eu

**Canada / USA**

**GARDENA** Canada Ltd.  
100 Summerlea Road  
Brampton, Ontario L6T 4X3  
Phone: (+1) 905 792 9330  
info@gardenacanada.com

**Chile**

Maquinarias Agroforestales  
Ltda. (Maga Ltda.)  
Santiago, Chile  
Avda. Chesterton  
# 8355 comuna Las Condes  
Phone: (+56) 2 202 4417  
Zitcon@magac.cl  
Datphone: 7560330

**China**

Husqvarna (Shanghai)  
Management Co., Ltd.  
富世华 (上海) 管理有限公司  
3F, Benq Square B,  
No207, Song Hong Rd.,  
Chang Ning District,  
Shanghai, PRC. 200335  
上海市长宁区淞虹路207号明  
基广场B座3楼, 邮编: 200335

**Colombia**

Husqvarna Colombia S.A.  
Calle 18 No. 68 D-31, zona  
Industrial de Montevideo  
Bogotá, Cundinamarca  
Tel. 571 2922700 ext. 105  
jairo.salazar@  
husqvarna.com.co

**Costa Rica**

Compania Exim  
Euroberoamericana S.A.  
Los Cologos, Moravia,  
200 metros al Sur del Colegio  
Saint Francis – San José  
Phone: (+506) 297 6883  
exim\_euro@racsca.com.cr

**Croatia**

Husqvarna Austria GmbH  
Industriezeile 36  
4010 Linz  
Tel.: (+43) 732 77 01 01-485  
service.gardena@  
husqvarnagroup.com

**Cyprus**

Med Marketing  
17 Digeni Akrita Ave  
P.O. Box 27017  
1641 Nicosia

**Czech Republic**

Husqvarna Česko s.r.o.  
Türkova 2319/5b  
149 00 Praha 4 – Chodov  
Bezplatná infolinka:  
800 100 425  
servis@cz.husqvarna.com

**Denmark**

**GARDENA DANMARK**  
Løjrvæg 19, st.  
3500 Værløse  
Tlf.: (+45) 70264770  
husqvarna@husqvarna.dk  
www.gardena.com/dk

**Dominican Republic**

**BOSQUESA, S.R.L**  
CARRETERA Santiago Licey  
Km. 5 ½  
Esquina Copal II,  
Santiago  
Dominican Republic  
Phone: (+809) 736-0333  
joserbosquesa@claro.net.do

**Ecuador**

Husqvarna Ecuador S.A.  
Agrupos E1-18 y 10 de  
Agosto Quito, Pichincha  
Tel. (+593) 22800739  
francisco.jacom@  
husqvarna.com.ec

**Estonia**

Husqvarna Eesti OÜ  
Valdeku 132  
EE-11216 Tallinn  
info@gardena.ee

**Finland**

Oy Husqvarna Ab  
Gardena Division  
Lautatarhankatu 8 B / PL 3  
00581 HELSINKI  
www.gardena.fi

**France**

Husqvarna France  
9/11 Allée des pierres mayettes  
92635 Gennevilliers Cedex  
France  
http://www.gardena.com/fr  
N° AZUR: 0 810 00 78 23  
(Prix d'un appel local)

**Georgia**

Transporter LLC  
8/57 Bellashvili street  
0159 Tbilisi, Georgia  
Phone: (+995) 322 14 71 71

**Great Britain**

Husqvarna UK Ltd  
Preston Road  
Aycliffe Industrial Park  
Newton Aycliffe  
County Durham  
DL5 6UP  
info.gardena@  
husqvarna.co.uk

**Greece**

Π. ΠΑΠΑΔΟΠΟΥΛΟΣ ΑΕΒΕ  
Λεωφ. Αθηνών 92  
Αθήνα  
ΕΛΛΑδα  
Τηλ. (+30) 210 5193100  
info@papadopoulos.com.gr

**Hungary**

Husqvarna Magyarorszáig Kft.  
Ezred u. 1-3  
1044 Budapest  
Telefon: (+36) 1 251-4161  
vevoszolgalat.husqvarna@  
husqvarna.hu

**Iceland**

O. Johnson & Kaaber  
Tunguhalsti 1  
110 Reykjavik  
ooj@oik.is

**India**

Husqvarna UK Ltd  
Preston Road  
Aycliffe Industrial Park  
Newton Aycliffe  
County Durham  
DL5 6UP  
info.gardena@  
husqvarna.co.uk

**Italy**

Husqvarna Italia S.p.A.  
Via Santa Vecchia 15  
23868 VALMADRERA (LC)  
Phone: (+39) 0341.203.111  
assistenza.italia@  
it.husqvarna.com

**Japan**

**KAKUICHI** Co. Ltd.  
Sumitomo Realty &  
Development Kojimachi  
BLDG., 8F  
5-1 Nibanencho  
Chiyoda-ku  
Tokyo 102-0084  
Phone: (+81) 33 264 4721  
m\_ishihara@kaku-ichi.co.jp

**Kazakhstan**

**LAMED** Ltd.  
155/1, Tazhibayev Str.  
050060 Almaty  
Irf Schmidt  
Abayavenue 3B  
110 005 Kostanay

**Korea**

Kyung Jin Trading Co., LTD.  
108-4, SunDuk Bld.,  
YangJae-dong,  
Secho-gu,  
Seoul, (zipcode: 137-891)  
Phone: (+82) (0)2 574-6300

**Kyrgyzstan**

Alye Maki  
av. Moladaya Guardir J 3  
720014  
Bishkek  
Lishek  
Husqvarna Latvija SIA  
Ulbrokas 19A  
LV-1021 Riga  
info@gardena.lv

**Lithuania**

**UAB Husqvarna Lietuva**  
Atleities pl. 77C  
LT-52104 Kaunas  
info@gardena.lt

**Luxembourg**

Magasins Jules Neuberg  
39, rue Jacques Stas  
Luxembourg-Gasperich 2549  
Case Postale No. 12  
Luxembourg 2010  
Phone: (+352) 40 14 01  
ap@neuberg.lu

**Mexico**

**AFOSA**  
Av. Lopez Mateos Sur # 5019  
Col. La Calma 45070  
Zapopan, Jalisco  
Mexico  
Phone: (+52) 33 3818-3434  
icornejo@afosa.com.mx

**Moldova**

Convel S.R.L.  
290A Munceşti Str.  
2002 Chisinau

**Netherlands**

Husqvarna Nederland B.V.  
**GARDENA** Division  
Postbus 50131  
1305 AC ALMERE  
Phone: (+31) 36 521 00 10  
info@gardena.nl

**Neth. Antilles**

Jonka Enterprises N.V.  
St. Rosa Weg 196  
P.O. Box 8200  
Curaçao  
Phone: (+599) 9 767 66 55  
pgm@jonka.com

**New Zealand**

Husqvarna New Zealand Ltd.  
PO Box 76-437  
Manukau City 2241  
Phone: (+64) (0) 9 9202410  
support.nz@husqvarna.co.nz

**Norway**

Husqvarna Norge AS  
Gardena Division  
Trøskneveien 36  
1708 Sarpsborg  
info@gardena.no

**Peru**

Husqvarna Perú S.A.  
Jr. Ramón Cárcamo 710  
Lima 1  
Tel.: (+51) 1 3320 400 ext. 416  
juan.remuzgo@  
husqvarna.com

**Poland**

Husqvarna  
Poland Spółka z o.o.  
ul. Wysockiego 15 b  
03-371 Warszawa  
Phone: (+48) 22 330 96 00  
gardena@husqvarna.com.pl

**Portugal**

Husqvarna Portugal, SA  
Lagoa - Albarraque  
2635 - 595 Rio de Mouro  
Rio: (+351) 21 922 85 30  
Fax: (+351) 21 922 85 36  
info@gardena.pt

**Romania**

Madex International Srl  
Soseaua Odail 117-123,  
RO 013603 Bucuresti, S 1  
Phone: (+40) 21 352.76.03  
madex@ines.ro

**Russia / Россия**

**ООО „Хускварна“**  
114100, Московская обл.,  
г. Химки,  
улица Ленинградская,  
владение 39, стр.6  
Бизнес Центр  
„Химки Бизнес Парк“,  
пояснение ОВ02\_04  
http://www.gardena.ru

**Serbia**

Domel d.o.o.  
Autoput za Novi Sad bb  
11279 Belgrade  
Phone: (+381) 118 488 88 12  
miroslav.jejina@domel.rs

**Singapore**

Hy-Ray PRIVATE LIMITED  
40 Jalan Pemimpin  
#02-08 Tat Ann Building  
Singapore 577185  
Phone: (+65) 6253 2277  
shying@hyray.com.sg

**Slovak Republic**

Husqvarna Česko s.r.o.  
Türkova 2319/5b  
149 00 Praha 4 – Chodov  
Bezplatná infolinka:  
800 154 044  
servis@sk.husqvarna.com

**Slovenia**

Husqvarna Austria GmbH  
Industriezeile 36  
4010 Linz  
Tel.: (+43) 732 77 01 01-485  
service.gardena@  
husqvarnagroup.com

**South Africa**

Husqvarna  
South Africa (Pty) Ltd  
Postnet Suite 250  
Private Bag X6,  
Cascades, 3202  
South Africa  
Phone: (+27) 33 846 9700  
info@gardena.co.za

**Spain**

Husqvarna España S.A.  
Calle de Rivas nº10  
28052 Madrid  
Phone: (+34) 91 708 05 00  
atencioncliente@gardena.es

**Suriname**

Agrofix n.v.  
Verlengde Hogestraat # 22  
Phone: (+597) 472426  
agrofix@sr.net  
Pobox: 2006  
Paramaribo  
Suriname – South America

**Sweden**

Husqvarna AB  
Gardena Division  
S-561 82 Huskvarna  
gardenaorder@husqvarna.se

**Switzerland / Schweiz**

Husqvarna Schweiz AG  
Consumer Products  
Industriestrasse 10  
5506 Mägenwil  
Phone: (+41) (0) 62 887 37 90  
info@gardena.ch

**Turkey**

Dost Bağçe Diş Ticaret  
Müessesli A.Ş.  
Yunus Mah. Adil Sok. No:3  
Ic Kapı No:1 Kartal  
34873 Istanbul  
Phone: (+90) 216 38 93 939  
info@dostabhce.com.tr

**Ukraine / Україна**

**ТОВ „Хускварна Україна“**  
вул. Васильківська, 34,  
офіс 204-р  
03022, м. Київ  
Тел. (+38) 044 998 90 02  
info@gardena.ua

**Uruguay**

**FELI SA**  
Entre Rios 1083 CP 11800  
Montevideo – Uruguay  
Tel: (+598) 22 03 18 44  
info@felisa.com.uy

**Venezuela**

Corporación Casa y Jardín C.A.  
Av. Caroni, Edif. Trezmen, PB.  
Colinas de Bello Monte.  
1050 Caracas.  
Tlf: (+58) 212 992 33 22  
info@casayjardin.net.ve

19032.20.962.01/1219  
© GARDENA  
Manufacturing GmbH  
D-89070 Ulm  
http://www.gardena.com