

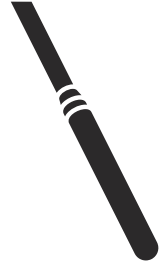

 **Husqvarna**<sup>®</sup>



SMART 40/40E, SMART 48/48E,  
SMART 56/56E, SMART 65

---

# Contents

---

Introduction.....	2	Troubleshooting.....	10
Safety.....	3	Storage and disposal.....	12
Operation.....	6	Technical data.....	13
Maintenance.....	7	EC Declaration of Conformity.....	15

---

## Introduction

---

### Product description

The product is a concrete vibrator with a built-in frequency converter.

### Intended use

The product is for professional operation only. The product removes air bubbles from wet concrete. Do not use the product for other tasks.

### Product overview

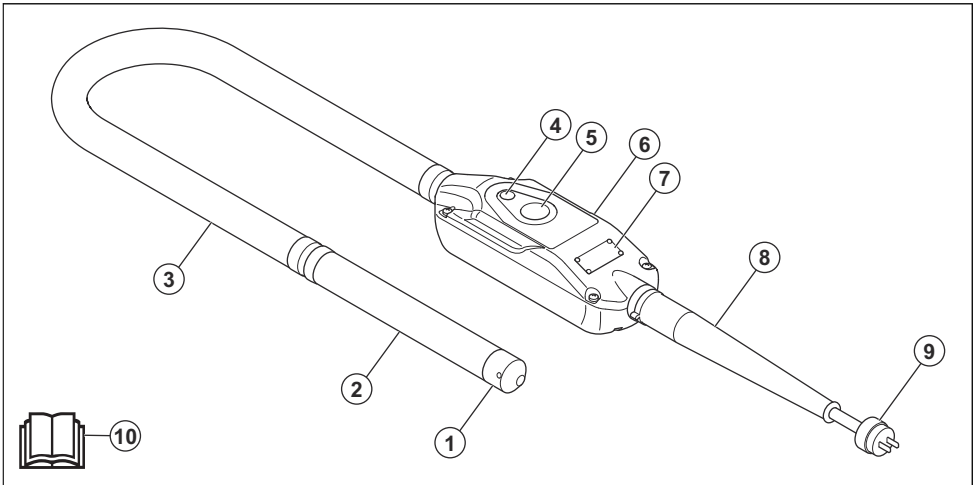

1. End cap
2. Vibrator head
3. Hose
4. LED indicator
5. ON/OFF button
6. Frequency converter
7. Rating plate
8. Rubber sleeve
9. Electrical cable with power plug
10. Operator's manual



Read the manual carefully and make sure that you understand the instructions before you use the product.



Use approved protective gloves.



Use hearing protection.

### Symbols on the product



**WARNING:** This product can be dangerous and cause serious injury or death to the operator or others. Be careful and use the product correctly.



This product is in compliance with applicable EC directives.

**Note:** Other symbols/decals on the product refer to special certification requirements for some markets.

## Rating plate

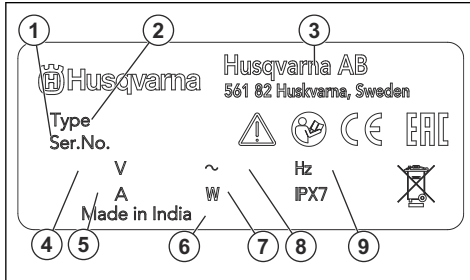

1. Serial number
2. Product type
3. Manufacturer

4. Voltage, V
5. Current, A
6. Production year
7. Rated power
8. Phase
9. Frequency, Hz

## Product liability

As referred to in the product liability laws, we are not liable for damages that our product causes if:

- the product is incorrectly repaired.
- the product is repaired with parts that are not from the manufacturer or not approved by the manufacturer.
- the product has an accessory that is not from the manufacturer or not approved by the manufacturer.
- the product is not repaired at an approved service center or by an approved authority.

## Safety

### Safety definitions

Warnings, cautions and notes are used to point out specially important parts of the manual.



**WARNING:** Used if there is a risk of injury or death for the operator or bystanders if the instructions in the manual are not obeyed.



**CAUTION:** Used if there is a risk of damage to the product, other materials or the adjacent area if the instructions in the manual are not obeyed.

**Note:** Used to give more information that is necessary in a given situation.

### General power tool safety warnings



**WARNING:** Read all safety warnings, instructions, illustrations and specifications provided with this power tool. Failure to follow all instructions listed below may result in electric shock, fire and/or serious injury.

- **Save all warnings and instructions for future reference.** The term "power tool" in the warnings refers to your mains-operated (corded) power tool or battery-operated (cordless) power tool.

### Work area safety

- **Keep work area clean and well lit.** Cluttered or dark areas invite accidents.

- **Do not operate power tools in explosive atmospheres, such as in the presence of flammable liquids, gases or dust.** Power tools create sparks which may ignite the dust or fumes.
- **Keep children and bystanders away while operating a power tool.** Distractions can cause you to lose control.

### Electrical safety

- **Power tool plugs must match the outlet. Never modify the plug in any way. Do not use any adapter plugs with earthed (grounded) power tools.** Unmodified plugs and matching outlets will reduce risk of electric shock.
- **Avoid body contact with earthed or grounded surfaces, such as pipes, radiators, ranges and refrigerators.** There is an increased risk of electric shock if your body is earthed or grounded.
- **Do not expose power tools to rain or wet conditions.** Water entering a power tool will increase the risk of electric shock.
- **Do not abuse the cord. Never use the cord for carrying, pulling or unplugging the power tool. Keep cord away from heat, oil, sharp edges or moving parts.** Damaged or entangled cords increase the risk of electric shock.
- **When operating a power tool outdoors, use an extension cord suitable for outdoor use.** Use of a cord suitable for outdoor use reduces the risk of electric shock.
- **If operating a power tool in a damp location is unavoidable, use a residual current device (RCD) protected supply.** Use of a RCD reduces the risk of electric shock.

## Personal safety

- **Stay alert, watch what you are doing and use common sense when operating a power tool. Do not use a power tool while you are tired or under the influence of drugs, alcohol or medication.** A moment of inattention while operating power tools may result in serious personal injury.
- **Use personal protective equipment. Always wear eye protection.** Protective equipment such as dust mask, non-skid safety shoes, hard hat or hearing protection used for appropriate conditions will reduce personal injuries.
- **Prevent unintentional starting. Ensure the switch is in the off-position before connecting to power source and/or battery pack, picking up or carrying the tool.** Carrying power tools with your finger on the switch or energising power tools that have the switch on invites accidents.
- **Remove any adjusting key or wrench before turning the power tool on.** A wrench or a key left attached to a rotating part of the power tool may result in personal injury.
- **Do not overreach. Keep proper footing and balance at all times.** This enables better control of the power tool in unexpected situations.
- **Dress properly. Do not wear loose clothing or jewellery. Keep your hair and clothing away from moving parts.** Loose clothes, jewellery or long hair can be caught in moving parts.
- **If devices are provided for the connection of dust extraction and collection facilities, ensure these are connected and properly used.** Use of dust collection can reduce dust-related hazards.
- **Do not let familiarity gained from frequent use of tools allow you to become complacent and ignore tool safety principles.** A careless action can cause severe injury within a fraction of a second.

## Power tool use and care

- **Do not force the power tool. Use the correct power tool for your application.** The correct power tool will do the job better and safer at the rate for which it was designed.
- **Do not use the power tool if the switch does not turn it on and off.** Any power tool that cannot be controlled with the switch is dangerous and must be repaired.
- **Disconnect the plug from the power source and/or remove the battery pack, if detachable, from the power tool before making any adjustments, changing accessories, or storing power tools.** Such preventive safety measures reduce the risk of starting the power tool accidentally.
- **Store idle power tools out of the reach of children and do not allow persons unfamiliar with the power tool or these instructions to operate the power tool.** Power tools are dangerous in the hands of untrained users.

- **Maintain power tools and accessories. Check for misalignment or binding of moving parts, breakage of parts and any other condition that may affect the power tool's operation. If damaged, have the power tool repaired before use.** Many accidents are caused by poorly maintained power tools.
- **Keep cutting tools sharp and clean.** Properly maintained cutting tools with sharp cutting edges are less likely to bind and are easier to control.
- **Use the power tool, accessories and tool bits etc. in accordance with these instructions, taking into account the working conditions and the work to be performed.** Use of the power tool for operations different from those intended could result in a hazardous situation.
- **Keep handles and grasping surfaces dry, clean and free from oil and grease.** Slippery handles and grasping surfaces do not allow for safe handling and control of the tool in unexpected situations.

## Service

- **Have your power tool serviced by a qualified repair person using only identical replacement parts.** This will ensure that the safety of the power tool is maintained.

## General safety instructions



**WARNING:** Read the warning instructions that follow before you use the product.

- This product is a dangerous tool if you are not careful or if you use the product incorrectly. This product can cause serious injury or death to the operator or others. Before you use the product, you must read and understand the contents of this operator's manual.
- Save all warnings and instructions.
- Comply with all applicable laws and regulations.
- The operator and the employer of the operator must know and prevent the risks during operation of the product.
- Do not let a person operate the product unless they read and understand the contents of the operator's manual.
- Do not operate the product unless you receive training before use. Make sure that all operators receive training.
- Do not let a child operate the product.
- Only let approved persons operate the product.
- The operator is responsible for accidents that occur to other persons or their property.
- Do not use the product if you are tired, ill, or under the influence of alcohol, drugs or medicine.
- Always be careful and use your common sense.
- This product produces an electromagnetic field during operation. This field can under some circumstances interfere with active or passive

medical implants. To decrease the risk of serious injury or death, we recommend persons with medical implants to speak to their physician and the medical implant manufacturer before operating this product.

- Keep the product clean. Make sure that you can clearly read signs and decals.
- Do not use the product if it is defective.
- Do not do modifications to this product.
- Do not operate the product if it is possible that other persons have done modifications to the product.

## Safety instructions for operation



**WARNING:** Read the warning instructions that follow before you use the product.

- Make sure that you know how to stop the product quickly in an emergency.
- The operator must have the physical strength that is necessary to operate the product safely.
- Use personal protective equipment. Refer to *Personal protective equipment on page 6*.
- Make sure that only approved persons are in the work area.
- Keep the work area clean and bright.
- Make sure that you are in a safe and stable position during operation.
- Make sure that there is no risk that you or the product can fall from a height.
- Make sure that there is no grease or oil on the handle.
- Do not use the product in areas where fire or explosions can occur.
- The product can cause objects to eject at high speed. Make sure that all persons in the work area use approved personal protective equipment. Remove loose objects from the work area.
- Before you go away from the product, stop the product and disconnect the power source.
- Make sure that the power outlet voltage agrees with the voltage that is given on the rating plate of the product.
- Make sure that clothes, long hair and jewelry do not get caught in moving parts.
- Do not sit on the product.
- Do not hit the product.
- Make sure that you or other persons cannot get caught in and fall on cables, hoses and shafts in the work area.
- Before you operate the product, find out if there are hidden wires, electrical cables or other sources of electricity. Do not operate the product unless you know that it is in a safe work area.

## Vibration safety



**WARNING:** Read the warning instructions that follow before you use the product.

- During operation of the product, vibrations go from the product to the operator. Regular and frequent operation of the product can cause or increase the degree of injuries to the operator. Injuries can occur in fingers, hands, wrists, arms, shoulders, and/or nerves and blood supply or other body parts. The injuries can be debilitating and/or permanent, and can increase gradually during weeks, months or years. Possible injuries include damage to the blood circulation system, the nervous system, joints, and other body structures.
- Symptoms can occur during operation of the product or at other times. If you have symptoms and continue to operate the product, the symptoms can increase or become permanent. If these or other symptoms occur, get medical aid:
  - Numbness, loss of feeling, tingling, pricking, pain, burning, throbbing, stiffness, clumsiness, loss of strength, changes in skin color or condition.
- Symptoms can increase in cold temperatures. Use warm clothing and keep your hands warm and dry when you operate the product in cold environments.
- Do maintenance on and operate the product as given in the operator's manual, to keep a correct vibration level.
- The product has a vibration damping system that decreases the vibrations from the handles to the operator. Let the product do the work. Do not push the product with force. Hold the product at the handles lightly, but make sure that you control the product and operate it safely. Do not push the handles into the end stops more than necessary.
- Keep your hands on the handle or handles only. Keep all other body parts away from the product.
- Stop the product immediately if strong vibrations suddenly occurs. Do not continue the operation before the cause of the increased vibrations is removed.

## Dust safety



**WARNING:** Read the warning instructions that follow before you use the product.

- Operation of the product can cause dust in the air. Dust can cause serious injury and permanent health problems. Silica dust is regulated as harmful by several authorities. These are examples of such health problems:
  - The fatal lung diseases chronic bronchitis, silicosis and pulmonary fibrosis

- Cancer
- Birth defects
- Skin inflammation
- Use correct equipment to decrease the quantity of dust and fumes in the air and to decrease dust on work equipment, surfaces, clothing and body parts. Examples of controls are dust collection systems and water sprays to bind dust. Decrease dust at the source where possible. Make sure that the equipment is correctly installed and used and that regular maintenance is done.
- Use approved respiratory protection. Make sure that the respiratory protection is applicable for the dangerous materials in the work area.
- Make sure that the airflow is sufficient in the work area.
- If it is possible, point the exhaust of the product where it cannot cause dust to go into the air.

### Noise safety



**WARNING:** Read the warning instructions that follow before you use the product.

- High noise levels and long-term exposure to noise can cause noise-induced hearing loss.
- To keep the noise level to a minimum, do maintenance on and operate the product as given in the operator's manual.
- Use approved hearing protection while you operate the product.
- Listen for warning signals and voices when you use hearing protection. Remove the hearing protection when the product is stopped, unless hearing protection is necessary for the noise level in the work area.

### Personal protective equipment



**WARNING:** Read the warning instructions that follow before you use the product.

- Always use approved personal protective equipment when you operate the product. Personal protective equipment cannot fully prevent injury but it

decreases the degree of injury if an accident does occur. Let your dealer help you select the correct personal protective equipment.

- Regularly do a check of the condition of the personal protective equipment.
- Use an approved protective helmet.
- Use approved hearing protection.
- Use approved respiratory protection.
- Use approved eye protection with side protection.
- Use protective gloves.
- Use boots with steel toe-cap and non-slip sole.
- Use approved work clothing or equivalent close-fitting clothing that has long sleeves and long legs.

### Safety instructions for maintenance



**WARNING:** Read the warning instructions that follow before you use the product.

- If the maintenance is not done correctly and regularly, the risk of injury and damage to the product increases.
- Use personal protective equipment. Refer to *Personal protective equipment on page 6*.
- Clean the product to remove dangerous material before you do the maintenance.
- Disconnect the product from the power source before you do the maintenance.
- Do not do modifications to the product. Modifications that are not approved by the manufacturer can cause serious injury or death.
- Always use original accessories and spare parts. Accessories and spare parts that are not approved by the manufacturer, can cause serious injury or death.
- Replace damaged, worn or broken parts.
- Only do the maintenance as given in this operator's manual. Let an approved service agent do all other servicing.
- After maintenance, do a check of the vibration level in the product. If it is not correct, speak to an approved service agent.
- Let an approved service agent do servicing on the product regularly.

## Operation

### Introduction



**WARNING:** Read and understand the safety chapter before you use the product.

### To start and stop the product

**Note:** Only use the product with a residual-current device (RCD). The RCD must have a protection for 16 A or more. The product is a grounded class 1 device.

1. Connect the product to an applicable power socket.
2. Push the ON/OFF button to start the product. The vibration starts after 1.5 seconds.

**Note:** The vibrations start at a very low speed and then increases slowly to maximum speed.

3. Push the ON/OFF button to stop the product.
4. Disconnect the product from the power socket.
5. Push and hold the ON/OFF button pushed for 5 seconds. This removes the voltage from the capacitors and prevents injury from remaining electricity on the plug pins.

## To operate the product



**CAUTION:** Do not use the product to move the concrete to the side.

1. Fill concrete in equally thick layers, 30–50 cm / 12–19 in. (B).
2. Put the vibrator head approximately 15 cm / 6 in. (A) down into the nearest lower layer of concrete. This causes the layers of concrete to mix correctly.

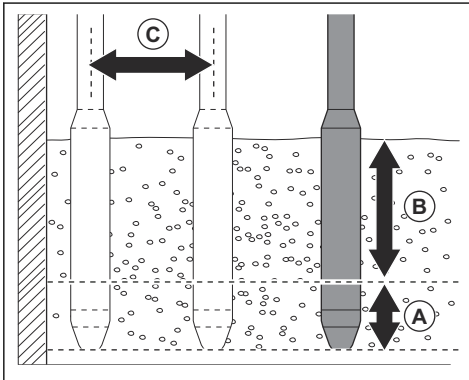

3. Wait approximately 10–20 seconds until the surface around the vibrator head is shiny and no air bubbles come to the surface.

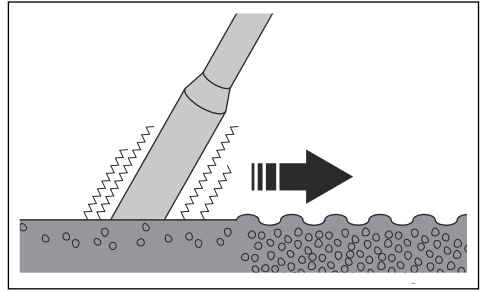

4. Remove the vibrator head slowly to let the concrete fill the hole from the vibrator head.
5. Put the vibrator head down into the concrete at a distance of 30–50 cm / 12–19 in. (C) from where you put it before.
6. Do step 4 and 5 again and again. Continue until the air bubbles are fully removed from the area of concrete.

## Maintenance

### Introduction



**WARNING:** Read and understand the safety chapter before you do maintenance on the product.

### To clean the product



**CAUTION:** Do not use a high-pressure washer to clean the product.

- Use running water from a hose to clean the product.
- Remove concrete from the surfaces of the product after each operation before the concrete becomes hard.
- Remove grease and oil from the handle.

### To remove the vibrator head

1. Disconnect the product from the power outlet.
2. Cut and discard the clamp that holds the wires on the hose end that is adjacent to the frequency converter.
3. Remove the cover from the frequency converter.
4. Cut the 3 connector wires and disconnect the ground wire from the frequency converter.
5. Pull the hose from the end that is adjacent to the frequency converter and remove the nut from the casing.
6. Put the vibrator head in a tube vise and tighten the tube vise fully.
7. Cut and discard the clamp that holds the wires on the hose end that is adjacent to the vibrator head. Pull the red hose until you can see the connectors.

- Cut and discard the thermal insulation and disconnect the terminals.
- Disconnect the ground wire from the hose nipple.

## To disassemble and assemble the vibrator head



**WARNING:** The vibrator head contains high voltage components. Wait 2 minutes after operation before you disassemble the vibrator head.

- Remove the end cap (A) from the stator tube (B).

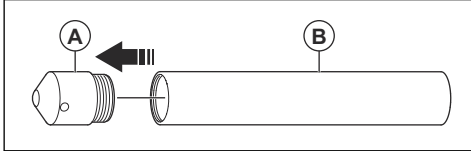

**Note:** The end cap (A) has a right hand thread.

- Remove the nut (C), the wire cover (D) and the rubber gasket (E).

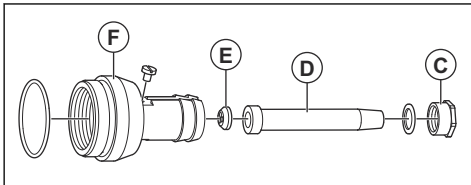

**Note:** The nut (C) has a right hand thread.

- Remove the hose nipple (F).

**Note:** The hose nipple (F) has a right hand thread.

- Use an applicable rod and rubber hammer to carefully push the rotor (G) through the bearing holder (H).

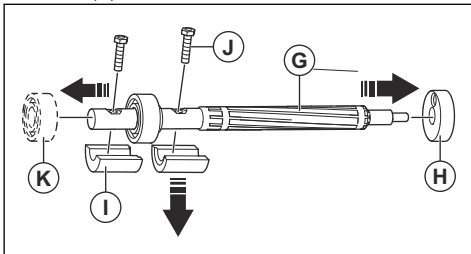

- Remove the bearing holder (H), the eccentric element (I) and the screws (J).
- Remove the bearing (K).
- Clean and examine the vibrator head. Refer to *To clean and examine the vibrator head on page 8*.

- Assemble the vibrator head in the opposite sequence.



**CAUTION:** If you replace the screws (J), make sure that they are not too long. If the screws go through the eccentric element, they can touch the inner surface of the stator tube. This prevents movement of the rotor and can cause damage to the product.

## To clean and examine the vibrator head

**Note:** Replace the O-rings regularly.

- Examine the vibrator head for damage and wear. Replace damaged parts.
- Clean all parts.



**CAUTION:** Do not use high pressure water to clean the drive unit.

- Fill the vibrator head with oil, refer to *Lubrication on page 9*.
- Examine the end cap for damage. Replace the end cap if it is damaged.

## To install the end cap



**CAUTION:** Wait 6 hours after you install the end cap before you use the product.

- Carefully clean the threads of the vibrator head. Make sure that the parts are dry with no oil, grease or dirt.
- Apply 4 strings of threadlocker vertically on the end cap threads. Make sure that you use the correct threadlocker type, refer to *Tightening torque and threadlocker type on page 9*. Make sure that no threadlocker goes into the vibrator head.
- Put oil into the end cap. Keep the end cap vertical and make sure that no oil goes on the end cap threads.
- Keep the end cap vertical and install the stator tube.



**CAUTION:** Do not tilt the end cap when you install the stator tube. If oil goes on the end cap thread, the threadlocker does not lock the thread.

- Tighten the end cap to the specified torque, refer to *Tightening torque and threadlocker type on page 9*.



## To install the vibrator head

1. Connect the ground wire to the the hose nipple on the vibrator head.
2. Attach the screw to the hose nipple and the vibrator head with a threadlocker. Make sure that you use the correct threadlocker type, refer to *Tightening torque and threadlocker type on page 9*.
3. Use connectors to keep the wires together. Use thermal insulation to connect the wires to the stator.
4. Put the wires into the red hose and put the red hose adjacent to the gland.
5. Use a clamp to connect the hose to the hose nipple on the vibrator head.
6. Move the wires into the frequency converter casing, through the gland.
7. Tighten the nut and put the red hose on the hose nipple on the frequency converter. Attach the red hose with a clamp.
8. Use connectors to connect the wires in the frequency converter.
9. Put the cover on the frequency converter.

## Lubrication

Vibrator head	SMART40/ 40E	SMART48/ 48E	SMART56/ 56E	SMART65
Shell T46, cm <sup>3</sup> (cl)	5 (0.5)	10 (1)	15 (1.5)	20 (2)

## Tightening torque and threadlocker type

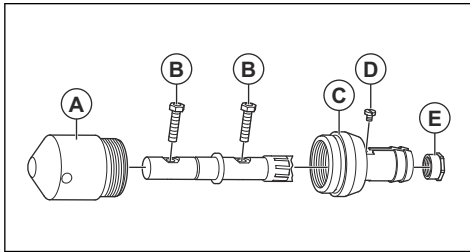

Tightening torque, Nm				
Vibrator head	40/ 40E	48/ 48E	56/ 56E	65
End cap (A)	170 Nm	350 Nm	520 Nm	750 Nm
Screw (B)	5 Nm	8 Nm	8 Nm	20 Nm
Nipple (C)	120 Nm	200 Nm	250 Nm	250 Nm

Threadlocker type				
Vibrator head	40/ 40E	48/ 48E	56/ 56E	65
End cap (A)	LOCTITE®638™	LOCTITE®638™	LOCTITE®638™	LOCTITE®638™
Nipple (C)	LOCTITE®243™	LOCTITE®243™	LOCTITE®243™	LOCTITE®243™
Thrust screw (D) <sup>1</sup>	LOCTITE®243™	LOCTITE®243™	LOCTITE®243™	LOCTITE®243™

<sup>1</sup> The thrust screw holds the ground cable and seals the vibrator head. If the thrust screw is not sealed correctly, oil can leak from the vibrator head.

Threadlocker type				
Vibrator head	40/ 40E	48/ 48E	56/ 56E	65
Screw (E)	LOCTITE®243™	LOCTITE®243™	LOCTITE®243™	LOCTITE®243™

---

## Troubleshooting

---

Problem	Cause	Solution
The residual-current device is released.	Damaged cable or plug.	Examine the cable and plug. If it is necessary, replace damaged or defective parts.
	Damaged frequency converter.	Replace the frequency converter.
Problem with the frequency converter.	Overload in the frequency converter because of a defective part.	Replace the defective part.
	The vibrator head can not move freely.	Stop the frequency converter and wait 30 seconds. Start the frequency converter.

<b>Problem</b>	<b>Cause</b>	<b>Solution</b>
Not sufficient vibration.	Defective stator tube or wires.	Disconnect the product from the frequency converter. Disconnect the wires between the frequency converter and the vibrator head. Measure the resistance between phases on the side of the vibrator head. Compare the values with those on the rating plate and with the table, refer to <i>Technical data on page 13</i> . If the values are incorrect, examine the wires and the stator tube. Replace the defective part.
		Short circuit between phases and ground. Measure the resistance between each phase and the ground. If the resistance is 10 mega-ohms or less, examine the wires and the stator tube. Replace the defective part.
	Damaged parts.	Lift the product from the concrete, wait 2 minutes. Measure the input current to the product, refer to <i>Technical data on page 13</i> for maximum values. If the values are incorrect, disassemble the vibrator head and examine the parts. Replace damaged parts.
	Overload in the frequency converter.	Put the vibrator head into concrete. Measure the input current to the product. Make sure that the current is not more than the values on the rating plate.
	Overheating, temperature of the frequency converter casing is more than 60°C (140°F).	Wait until the temperature of the casing decreases 10°C (50°F).
The product stops during operation.	The residual-current device found a fault.	Examine the cables and the frequency converter. Replace the cable or the frequency converter.
	The product is too hot.	Stop the product and move it from sunlight.
	Overload in the product.	Examine if there is a short circuit between the phases on the vibrator head side.
Examine if there is a short circuit between the phases and ground on the side of the vibrator head.		

## LED light status

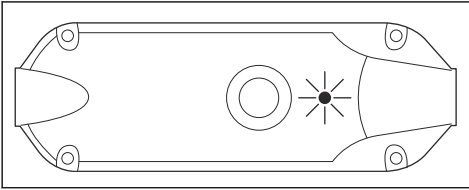

LED status	Product status	Procedure
Green light	Connected to the power source	N/A
Flashes green	Work in progress. Too low current.	Examine if the vibrator head is blocked or overload.
Flashes red	The frequency converter box or the vibrator head is too hot.	Let the frequency converter and vibrator head cool down.
Flashes green and red	Too high or too low voltage.	Examine the voltage of the power source.
Red light	Overload. Short circuit between phases. Insulation fault in the vibrator head. Problem in the frequency converter.	Examine the frequency converter and vibrator head for damage. If it is necessary, send the product to an authorised service center.

---

## Storage and disposal

---

### Storage

- Clean the product before storage.
- Keep the product in a dry and frost-free area.
- Keep the product in a locked area to prevent access for children or persons that are not approved.

### Disposal of the product

- Obey the local recycling requirements and applicable regulations.
- When the product no longer is used, send it to the dealer or discard it at a recycling location.

## Technical data

### Technical data

	SMART 40	SMART 40E	SMART 48	SMART 48E	SMART 56	SMART 56E	SMART 65
<b>Performance</b>							
Voltage, V	230/115	230/115	230/115	230/115	230/115	230/115	230/115
Stator resistance, Ohm, 230 V/115 V	26.50/6.60	26.50/6.60	9.30/2.40	9.30/2.40	5.60/1.50	5.60/1.50	2.60/ N/A
Input current, A, 230 V/115 V <sup>2</sup>	1.9/3.8	1.9/3.8	2.2/4.4	2.2/4.4	2.7/5.4	2.7/5.4	3.7/ N/A
Phases	1	1	1	1	1	1	1
Frequency, Hz	50/60	50/60	50/60	50/60	50/60	50/60	50/60
Power, W	400	400	920	920	1170	1170	1800
Input power, kW (electric drive unit)	0.40	0.40	0.92	0.92	1.17	1.17	1.80
Amperage, (A) 230 V/115 V	2.5/5	2.5/5	4.5/9	4.5/9	6.4/12.8	6.4/12.8	10/ N/A
Protection	IPX7	IPX7	IPX7	IPX7	IPX7	IPX7	IPX7
Max. speed at full load, rpm	12 000	12 000	12 000	12 000	12 000	12 000	12 000
Max. speed at full load (electric drive unit), rpm	12 000	12 000	12 000	12 000	12 000	12 000	12 000
Weighted effective acceleration uncertainty (K) m/s <sup>2</sup> <sup>3</sup>	3.81 (0.42)	<2.5	2.47 (0.44)	<2.5	5.87 (1.00)	<2.5	4.62 (0.66)
<b>Dimensions</b>							
Cable length (plug to frequency converter), m/ft	15/49.2	1.7/5.6	15/49.2	1.7/5.6	15/49.2	1.7/5.6	15/49.2
Cable length (frequency converter to handle) 230 V, m/ft	N/A	15/49.2	N/A	15/49.2	N/A	15/49.2	N/A
Cable length (frequency converter to handle) 115 V, m/ft	N/A	10/32.8	N/A	10/32.8	N/A	10/32.8	N/A
Frequency converter weight, kg/lbs	2.8/6.17	2.8/6.17	2.8/6.17	2.8/6.17	2.8/6.17	2.8/6.17	2.8/6.17
Operating weight, kg/lbs	13.1/28.88	12/26.40	14.7/32.40	13.6/29.98	15.9/35.05	14.8/32.63	18.5/40.78
Frequency converter length, mm/in.	300/11.8	300/11.8	300/11.8	300/11.8	300/11.8	300/11.8	300/11.8

<sup>2</sup> When the product is raised out of the concrete.

<sup>3</sup> Weighted effective acceleration measured in water at 2 meter (6.56 ft.) from the end of the poker according to EN ISO 5349.

	SMART 40	SMART 40E	SMART 48	SMART 48E	SMART 56	SMART 56E	SMART 65
Frequency converter width, mm/in.	103/4.05	103/4.05	103/4.05	103/4.05	103/4.05	103/4.05	103/4.05
Frequency converter height, mm/in.	80/3.14	80/3.14	80/3.14	80/3.14	80/3.14	80/3.14	80/3.14
Vibrator head diameter, mm/in.	40/1.58	40/1.58	48/1.90	48/1.90	56/2.20	56/2.20	65/2.56
Vibrator head length, mm/in.	320/12.59	320/12.59	350/13.78	350/13.78	380/14.96	380/14.96	410/16.14
Total weight, kg/lbs	2.3/5.0	2.3/5.0	3.9/8.6	4.2/9.3	5.1/11.2	5.2/11.5	7.7/16.9
<b>Noise emissions</b>							
Sound pressure level $L_p$ at the operators ear, dB(A) <sup>4</sup>	75	75	80	80	83	83	88
Sound power level $L_w$ measured, dB(A) rel 1pW <sup>5</sup>	86	86	91	91	94	94	99

## Noise and vibration declaration statement

These declared values were obtained by laboratory type testing in accordance with the stated directive or standards and are suitable for comparison with the declared values of other products tested in accordance with the same directive or standards. These declared values are not suitable for use in risk assessments and values measured in individual work places may be higher. The actual exposure values and risk of harm experienced by an individual user are unique and depend upon the way the user works, in what material the product is used, as well as upon the exposure time and the physical condition of the user, and the condition of the product.

<sup>4</sup> Noise level measured in air at 1m from the product according to EN ISO 3744. Uncertainty:  $\pm 3$ dB

<sup>5</sup> Noise level measured in air at 1m from the product according to EN ISO 3744. Uncertainty:  $\pm 3$ dB

---

# EC Declaration of Conformity

---

## EC Declaration of Conformity

We, **Husqvarna AB**, SE-561 82 Huskvarna, Sweden, tel:  
+46-36-146500, declare on our sole responsibility that  
the product:

<b>Description</b>	<b>Concrete Vibrator</b>
<b>Brand</b>	Husqvarna
<b>Type/Model</b>	SMART 40/40E/48/48E/56/56E/65
<b>Identification</b>	Serial numbers dating from 2020 and onwards

complies fully with the following EU directives and  
regulations:

<b>Directive/Regulation</b>	<b>Description</b>
2006/42/EC	"relating to machinery"
2014/30/EU	"relating to electromagnetic compatibility"
2011/65/EU	"relating to restriction of hazardous substances"

and that the following harmonized standards and/or  
technical specifications are applied;

EN 12649:2008+A1:2011

EN 55014-1:2017

EN 55014-2:2015

EN 61000-3-2:2014

EN 61000-3-3:2013

Partille, 2020-03-05



Martin Huber

R&D Director, Concrete Surfaces & Floors

Husqvarna AB, Construction Division

Responsible for technical documentation



[www.husqvarnacp.com](http://www.husqvarnacp.com)

Original instructions

1140466-26



2020-09-29