

EasyCut Li

Art. 9836

DE Betriebsanleitung Akku-Heckenschere	SK Návod na obsluhu Akumulátorové nožnice na živý plot
EN Operator's manual Battery Hedge Trimmer	EL Οδηγίες χρήσης Μπορντούροφάλιδο μπαταρίας
FR Mode d'emploi Taille-haies à batterie	RU Инструкция по эксплуатации Аккумуляторные ножницы для живой изгороди
NL Gebruiksaanwijzing Accu-heggenschaar	SL Navodilo za uporabo Akumulatorske škarje za živo mejo
SV Bruksanvisning Accu-häcksax	HR Upute za uporabu Baterijske škare za živicu
DA Brugsanvisning Hækkeklipper med accu	SR/ Uputstvo za rad Baterijske makaze za živicu
FI Käyttöohje Akkukäyttöinen pensasleikkuri	UK Інструкція з експлуатації Акумуляторний садовий секатор
NO Bruksanvisning Accu hekksaks	RO Instrucțiuni de utilizare Trimmer de gard viu cu baterie
IT Istruzioni per l'uso Tagliasiepi a batteria	TR Kullanma Kılavuzu Akülü çit budayıcı
ES Instrucciones de empleo Recortasetos con Accu	BG Инструкция за експлоатация Акумуляторна ножица за жив плет
PT Manual de instruções Corta sebes a bateria	SQ Manual përdorimi Prerëse ligustrash me bateri
PL Instrukcja obsługi Akumulatorowe nożyce do żywopłotu	ET Kasutusjuhend Akuga hekilõikur
HU Használati utasítás Akumulátoros sövénynyíró	LT Ekspluatavimo instrukcija Akumuliatorinės gyvatvorių žirklys
CS Návod k obsluze Akumulátorové nůžky na živý plot	LV Lietošanas instrukcija Ar akumulatoru darbināmas dzīvžoga šķēres

<p>DE Produkthaftung Wir weisen ausdrücklich darauf hin, dass wir in Übereinstimmung mit dem Produkthaftungsgesetz nicht für Schäden haften, die durch unsere Produkte entstehen, wenn diese unsachgemäß und nicht durch einen von uns autorisierten Servicepartner repariert wurden oder wenn keine Original GARDENA Teile oder von uns zugelassene Teile verwendet wurden.</p>
<p>EN Product liability In accordance with the German Product Liability Act, we hereby expressly declare that we accept no liability for damage incurred from our products where said products have not been properly repaired by a GARDENA-approved service partner or where original GARDENA parts or parts authorised by GARDENA were not used.</p>
<p>FR Responsabilité Conformément à la loi relative à la responsabilité du fait des produits défectueux, nous déclarons expressément par la présente que nous déclinons toute responsabilité pour les dommages résultant de nos produits, si lesdits produits n'ont pas été correctement réparés par un partenaire d'entretien agréé GARDENA ou si des pièces d'origine GARDENA ou des pièces agréées GARDENA n'ont pas été utilisées.</p>
<p>NL Productaansprakelijkheid Conform de Duitse wet inzake productaansprakelijkheid verklaren wij hierbij uitdrukkelijk dat wij geen aansprakelijkheid aanvaarden voor schade ontstaan uit onze producten waarbij deze producten niet zijn gerepareerd door een GARDENA-erkende servicepartner of waarbij geen originele GARDENA-onderdelen of onderdelen die door GARDENA zijn goedgekeurd zijn gebruikt.</p>
<p>SV Produktansvar I enlighet med tyska produktansvarslagar förklarar vi härmed uttryckligen att vi inte åtar oss något ansvar för skador som orsakas av våra produkter där produkterna inte har genomgått korrekt reparation från en GARDENA-godkänd servicepartner eller där originaldelar från GARDENA eller delar godkända av GARDENA inte använts.</p>
<p>DA Produktansvar I overensstemmelse med den tyske produktansvarslov erklærer vi hermed udtrykkeligt, at vi ikke påtager os noget ansvar for skader på vores produkter, hvis de pågældende produkter ikke er blevet repareret korrekt af en GARDENA-godkendt servicepartner, eller hvor der ikke er brugt originale GARDENA-reservedele eller godkendte reservedele fra GARDENA.</p>
<p>FI Tuotevastuu Saksan tuotevastuulain mukaisesti emme ole vastuussa laitteiden vaurioista, jos korjauksia ei ole tehnyt GARDENA:n hyväksymä huoltoliike tai jos niiden synnä on muiden kuin alkuperäisten GARDENA-varaosien tai GARDENA:n hyväksymien varaosien käyttö.</p>
<p>IT Responsabilità del prodotto In conformità con la Legge tedesca sulla responsabilità del prodotto, con la presente dichiariamo espressamente che decliniamo qualsiasi responsabilità per danni causati dai nostri prodotti qualora non siano stati correttamente riparati presso un partner di assistenza approvato GARDENA o laddove non siano stati utilizzati ricambi originali o autorizzati GARDENA.</p>
<p>ES Responsabilidad sobre el producto De acuerdo con la Ley de responsabilidad sobre productos alemana, por la presente declaramos expresamente que no aceptamos ningún tipo de responsabilidad por los daños ocasionados por nuestros productos si dichos productos no han sido reparados por un socio de mantenimiento aprobado por GARDENA o si no se han utilizado piezas originales GARDENA o piezas autorizadas por GARDENA.</p>
<p>PT Responsabilidade pelo produto De acordo com a lei alemã de responsabilidade pelo produto, declaramos que não nos responsabilizamos por danos causados pelos nossos produtos, caso os tais produtos não tenham sido devidamente reparados por um parceiro de assistência GARDENA aprovado ou se não tiverem sido utilizadas peças GARDENA originais ou peças autorizadas pela GARDENA.</p>
<p>PL Odpowiedzialność za produkt Zgodnie z niemiecką ustawą o odpowiedzialności za produkt, niniejszym wyraźnie oświadczamy, że nie ponosimy żadnej odpowiedzialności za szkody poniesione na skutek użytkowania naszych produktów, w przypadku gdy naprawa tych produktów nie była odpowiednio przeprowadzana przez zatwierdzonego przez firmę GARDENA partnera serwisowego lub nie stosowano oryginalnych części GARDENA albo części autoryzowanych przez tę firmę.</p>
<p>HU Termékszavatosság A németországi termékszavatossági törvénnyel összhangban ezennel nyomatékosan kijelentjük, hogy nem vállalunk felelősséget a termékeinkben keletkezett olyan károkért, amelyek valamely GARDENA által jóváhagyott szervizpartner által nem megfelelően végzett javításból adódtak, vagy amely során nem eredeti GARDENA alkatrészeket vagy a GARDENA által jóváhagyott alkatrészeket használtak fel.</p>
<p>CS Odpovědnost za výrobek V souladu s německým zákonem o odpovědnosti za výrobek tímto výslovně prohlašujeme, že nepřijímáme žádnou odpovědnost za poškození vzniklá na našich výrobcích, kdy zmíněné výrobky nebyly řádně opraveny schváleným servisním partnerem GARDENA nebo kdy nebyly použity originální náhradní díly GARDENA nebo náhradní díly autorizované společností GARDENA.</p>
<p>SK Zodpovednosť za produkt V súlade s nemeckými právnymi predpismi upravujúcimi zodpovednosť za výrobok týmto výslovné prehlasujeme, že nenesieme žiadnu zodpovednosť za škody spôsobené našimi výrobkami, v prípade ktorých neboli náležité opravy vykonané servisným partnerom schváleným spoločnosťou GARDENA alebo neboli použité diely spoločnosti GARDENA alebo diely schválené spoločnosťou GARDENA.</p>
<p>EL Ευθύνη προϊόντος Σύμφωνα με τον γερμανικό νόμο περί Ευθύνης για τα Προϊόντα, με το παρόν δηλώνουμε ρητώς ότι δεν αποδεχόμαστε καμία ευθύνη για τυχόν ζημιές που προκύπτουν από τα προϊόντα μας εάν αυτά δεν έχουν επισκευαστεί σωστά από κάποιον συγκεκριμένο συνεργάτη επισκευών της GARDENA ή εάν δεν έχουν χρησιμοποιηθεί αυθεντικά εξαρτήματα GARDENA ή εξαρτήματα συγκεκριμένα από την GARDENA.</p>
<p>SL Odgovornost proizvajalca V skladu z nemškimi zakoni o odgovornosti za izdelke, izrecno izjavljajo, da ne sprejemamo nobene odgovornosti za škodo, ki jo povzročijo naši izdelki, če teh niso ustrezno popravili GARDENINI odobreni servisni partnerji ali pri tem niso bili uporabljeni originalni GARDENINI nadomestni deli ali GARDENINIMI homologiranimi nadomestnimi deli.</p>
<p>HR Pouzdanost proizvoda Sukladno njemačkom zakonu o pouzdanosti proizvoda, ovime izričito izjavljujemo kako ne prihvaćamo nikakvu odgovornost za oštećenja na našim proizvodima nastala uslijed neispravnog popravka od strane servisnog partnera kojeg odobrava GARDENA ili uslijed nekorištenja originalnih GARDENA dijelova ili dijelova koje odobrava GARDENA.</p>
<p>RO Răspunderea pentru produs În conformitate cu Legea germană privind răspunderea pentru produs, declarăm în mod expres prin prezentul document că nu acceptăm nicio răspundere pentru defecțiunile suferite de produsele noastre atunci când acestea nu au fost reparate în mod corect de un atelier de service partener, aprobat de GARDENA, sau când nu au fost utilizate piese GARDENA originale sau piese autorizate de GARDENA.</p>
<p>BG Отговорност за вреди, причинени от стоки Съгласно германския Закон за отговорността за вреди, причинени от стоки, с настоящото изрично декларираме, че не носим отговорност за щети, причинени от нашите продукти, ако те не са били правилно ремонтирани от одобрен от GARDENA сервиз или ако не са използвани оригинални части на GARDENA или части, одобрени от GARDENA.</p>
<p>ET Tootevastutus Vastavalt Saksamaa tootevastutusseadusele deklareerime käesolevaga selgesõnaliselt, et me ei kanna mingisugust vastutust meie toodetest tingitud kahjude eest, kui need tooted ei ole korrektselt parandatud GARDENA heakskiidetud hoolduspartneri poolt või kui parandamisel ei ole kasutatud GARDENA originaalosi või GARDENA volitatud osi.</p>
<p>LT Gaminio patikimumas Mes aiškiai pareiškiame, kad, atsižvelgiant į Vokietijos gaminių patikimumo įstatymą, nepriisiame atsakomybės dėl bet kokios žalos, patirtos dėl mūsų gaminių, jeigu jie buvo netinkamai taisomi arba jų dalys buvo pakeistos neoriginaliomis GARDENA dalimis ar nepatvirtintomis dalimis, arba jeigu remonto darbai buvo atliekami ne GARDENA techninės priežiūros centro specialistų.</p>
<p>LV Atbildība par produkcijas kvalitāti Saskaņā ar Vācijas likumu par atbildību par produkcijas kvalitāti ar šo mēs paziņojam, ka neuzņemamies atbildību par bojājumiem, kas radušies, lietojot mūsu izstrādājumus, kuru remontu nav veicis uzņēmuma GARDENA apstiprināts apkopes partneris vai kuru remontam netika izmantotas oriģinālās GARDENA detaļas vai detaļas, kuru lietošanu apstiprinājis uzņēmums GARDENA.</p>

01

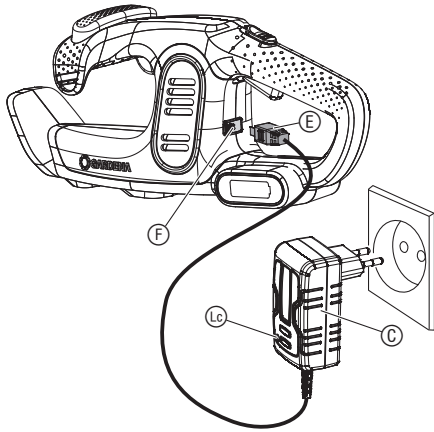

02

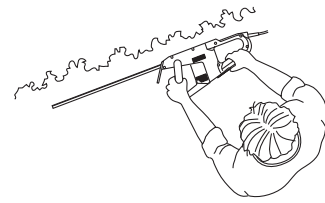

03

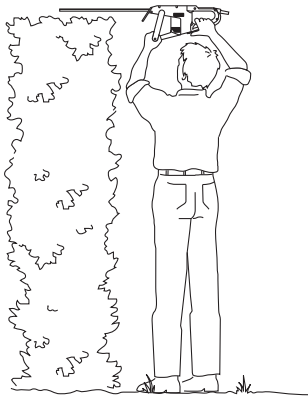

04

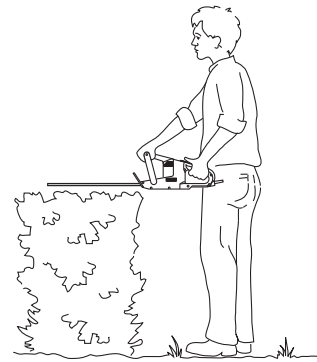

05

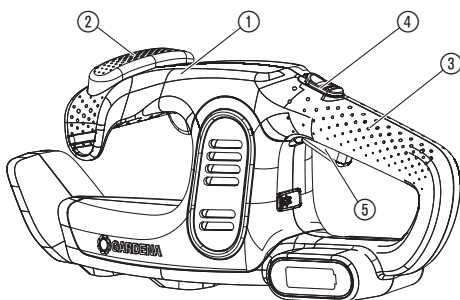

M1

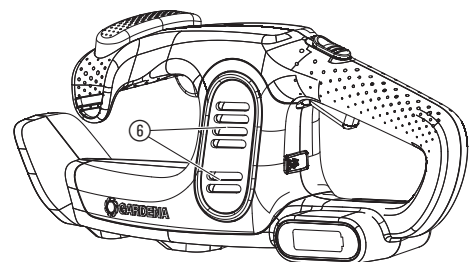

EN

1. SAFETY	8
2. OPERATION.	9
3. MAINTENANCE	9
4. STORAGE	10
5. TROUBLESHOOTING	10
6. TECHNICAL DATA	10
7. ACCESSORIES	10
8. SERVICE/WARRANTY.	10

Translation of the original instructions.



This product is not intended for use by persons (including children) with reduced physical, sensory or mental capabilities, or lack of experience and knowledge, unless they have been given supervision or instruction concerning use of the product by a person responsible for their safety. Children should be supervised to ensure that they do not play with the product. The use of this product by young people under the age of 16 is not recommended.

Intended use:

The GARDENA Hedge Trimmer is intended to cut hedges, shrubs and grass coverings in private domestic gardens and allotments.

The product is not intended for long term use.

DANGER! Risk of injury!

Do not use the product to cut lawns/lawn edges, to chop up material or to make compost.

1. SAFETY

IMPORTANT!

Read the operator's manual carefully before use and keep for future reference.

Symbols on the product:



Read operator's manual.



Always wear approved hearing protection.
Always wear approved eye protection.



Danger – Keep hands away from blade.



Do not expose to rain.



For the charger:
Remove plug from the mains immediately if the cable is damaged or cut.

General safety warnings

General power tool safety warnings:



WARNING!

Read all safety warnings and all instructions! Failure to follow the warnings and instructions may result in electric shock, fire and/or serious injury.

Save all warnings and instructions for future reference.

The term "power tool" in the warnings refers to your mains operated (corded) power tool or battery operated (cordless) power tool.

1) Work area safety

- a) **Keep work area clean and well lit.** Cluttered or dark areas invite accidents.
- b) **Do not operate power tools in explosive atmospheres, such as in the presence of flammable liquids, gases or dust.** Power tools create sparks which may ignite the dust or fumes.
- c) **Keep children and bystanders away while operating a power tool.** Distractions can cause you to lose control.

2) Electrical safety

- a) **Power tool plugs must match the outlet. Never modify the plug in any way. Do not use any adaptor plugs with earthed (grounded) power tools.**
Unmodified plugs and matching outlets will reduce risk of electric shock.
- b) **Avoid body contact with earthed or grounded surfaces, such as pipes, radiators, ranges and refrigerators.** There is an increased risk of electric shock if your body is earthed or grounded.
- c) **Do not expose power tools to rain or wet conditions.**
Water entering a power tool will increase the risk of electric shock.
- d) **Do not abuse the cord. Never use the cord for carrying, pulling or unplugging the power tool. Keep cord away from heat, oil, sharp edges or moving parts.**
Damaged or entangled cords increase the risk of electric shock.
- e) **When operating a power tool outdoors, use an extension cord suitable for outdoor use.**
Use of a cord suitable for outdoor use reduces the risk of electric shock.
- f) **If operating a power tool in a damp location is unavoidable, use a residual current device (RCD) protected supply.**
Use of an RCD reduces the risk of electric shock.

3) Personal safety

- a) **Stay alert, watch what you are doing and use common sense when operating a power tool. Do not use a power tool while you are tired or under the influence of drugs, alcohol or medication.** A moment of inattention while operating power tools may result in serious personal injury.
- b) **Use personal protective equipment. Always wear eye protection.**
Protective equipment such as dust mask, non-skid safety shoes, hard hat, or hearing protection used for appropriate conditions will reduce personal injuries.
- c) **Prevent unintentional starting. Ensure the switch is in the off-position before connecting to power source and /or battery pack, picking up or carrying the tool.** Carrying power tools with your finger on the switch or energising power tools that have the switch on invites accidents.
- d) **Remove any adjusting key or wrench before turning the power tool on.**
A wrench or a key left attached to a rotating part of the power tools may result in personal injury.
- e) **Do not overreach. Keep proper footing and balance at all times.**
This enables better control of the power tool in unexpected situations.
- f) **Dress properly. Do not wear loose clothing or jewellery. Keep your hair, clothing and gloves away from moving parts.**
Loose clothes, jewellery or long hair can be caught in moving parts.

- g) **If devices are provided for the connection of dust extraction and collection facilities, ensure these are connected and properly used.**
Use of dust collection can reduce dust-related hazards.

4) Power tool use and care

- a) **Do not force the power tool. Use the correct power tool for your application.** The correct power tool will do the job better and safer at the rate for which it was designed.
- b) **Do not use the power tool if the switch does not turn it on and off.**
Any power tool that cannot be controlled with the switch is dangerous and must be repaired.
- c) **Disconnect the plug from the power source and /or the battery pack from the power tool before making any adjustments, changing accessories, or storing power tools.** Such preventive safety measures reduce the risk of starting the power tool accidentally.
- d) **Store idle power tools out of the reach of children and do not allow persons unfamiliar with the power tool or these instructions to operate the power tool.**
Power tools are dangerous in the hands of untrained users.
- e) **Maintain power tools. Check for misalignment or binding of moving parts, breakage of parts and any other condition that may affect the power tool's operation. If damaged, have the power tool repaired before use.** Many accidents are caused by poorly maintained power tools.
- f) **Keep cutting tools sharp and clean.** Properly maintained cutting tools with sharp cutting edges are less likely to bind and are easier to control.
- g) **Use the power tool, accessories and tool bits etc. in accordance with these instructions, taking into account the working conditions and the work to be performed.** Use of the power tool for operations different from those intended could result in a hazardous situation.

5) Battery tool use and care

- a) **Recharge only with the charger specified by the manufacturer.**
A charger that is suitable for one type of battery pack may create a risk of fire when used with another battery pack.
- b) **Use power tools only with specifically designated battery packs.**
Use of any other battery packs may create a risk of injury and fire.
- c) **When battery pack is not in use, keep it away from other metal objects, like paper clips, coins, keys, nails, screws or other small metal objects, that can make a connection from one terminal to another.** Shorting the battery terminals together may cause burns or a fire.
- d) **Under abusive conditions, liquid may be ejected from the battery; avoid contact. If contact accidentally occurs, flush with water. If liquid contacts eyes, additionally seek medical help.**
Liquid ejected from the battery may cause irritation or burns.

6) Service

Have your power tool serviced by a qualified repair person using only identical replacement parts.

This will ensure that the safety of the power tool is maintained.

Hedge trimmer safety warnings:

- **Keep all parts of the body away from the cutter blade. Do not remove cut material or hold material to be cut when blades are moving. Make sure the switch is off when clearing jammed material.**
A moment of inattention while operating the hedge trimmer may result in serious personal injury.
- **Carry the hedge trimmer by the handle with the cutter blade stopped. When transporting or storing the hedge trimmer always fit the cutting device cover.** Proper handling of the hedge trimmer will reduce possible personal injury from the cutter blades.
- **Hold the power tool by insulated gripping surfaces only, because the cutter blade may contact hidden wiring or its own cord.**
Cutter blades contacting a "live" wire may make exposed metal parts of the power tool "live" and could give the operator an electric shock.
- **Keep cable away from the cutting area.** During operation the cable may be hidden in shrubs and can be accidentally cut by the blade.

Additional safety warnings

Battery safety



DANGER! Fire risk!

The battery product to be charged must be placed on a non-flammable, heat resistant and non-conductive surface while charging.

The battery must not be charged unattended.

Keep corrosive, flammable and easily combustible objects clear of the battery charger and the battery product.

Do not cover the battery charger and the battery product while charging.

Disconnect the battery charger immediately in the event of smoke formation or fire.

Only use the original GARDENA Charger to charge the battery. The use of other battery chargers may damage the batteries irreparably and even cause a fire.

Do not use the GARDENA charger to charge external rechargeable batteries, as GARDENA cannot guarantee compatibility and could therefore present a risk of fire or explosion.

Do not charge non-rechargeable batteries.



DANGER! Risk of explosion!

Protect battery products from heat and fire. Do not leave on radiators or expose to strong sunshine for long periods.

Do not operate them in explosive atmospheres, e.g. in the presence of flammable liquids (vapours), flammable gases or accumulations of dust. Batteries may create sparks which could ignite the mixtures.

Only charge and use the battery product in ambient temperatures of between 0 °C and 40 °C. Allow battery to cool down after long periods of use.

Check the charging cable regularly for signs of damage or ageing (brittleness). Only use it in perfect condition.

Do not stow or transport the battery product above 45 °C or in direct sunlight. Ideally, the battery product should be stored below 25 °C so that self-discharge is low.

Do not expose the battery product to rain, water (immersion) or wet conditions. Water entering a battery product will increase the risk of electric shock.

If usage of the battery is not planned for a certain time (winter period) reload the battery to avoid a deep discharge.

Do not store the battery product in places where static electricity is present.

Electrical safety



DANGER! Cardiac arrest!

This product makes an electromagnetic field while it operates. This field may under some conditions interfere with active or passive medical implants. To decrease the risk of conditions that can possibly injure or kill, we recommend persons with medical implants to speak with their physician and the medical implant manufacturer before you operate the product.

Only use the battery product between 0 °C and 40 °C.

Thoroughly inspect the area where the product is to be used and remove all wires and other foreign objects.

Before using the product and after any impact, check for signs of wear or damage and repair as necessary.

If the product can no longer be switched off in the event of a defect, place the product on a solid surface and monitor it until the battery is empty. Send the defective product to our GARDENA Service Centre.

Never attempt to use an incomplete product or one with an unauthorised modification.

Stop the product if the product starts to vibrate abnormally. Check immediately. Excessive vibration can cause injury.

Do not use the product nearby a water.

Do not operate next to swimming pools or garden ponds.

Personal safety



DANGER! Risk of suffocation!

Small parts can be easily swallowed. There is also a risk that the poly-bag can suffocate toddlers. Keep toddlers away when you assemble the product.



DANGER! Risk of injury!

If the device switches off due to an empty battery (charging control lamp  flashes green), it may happen that the battery recovers after a certain time. The device is then ready for operation again.

Know how to stop the product quickly in an emergency.

Avoid contact to the oil of the blade in particular when you react allergic with it.

Only work in the daylight or when visibility is good.

Check your product before each use. Always visually inspect your Hedge Trimmer before each use. Check that the ventilation slots are not obstructed in any way.

Check the blade before usage.

Keep the blade well maintained.

If the product got hot while operation, let it cool down before storage.

Do not overload the product.

Warning! When wearing hearing protection, and due to the noise produced by the product, the operator may not notice persons approaching.

Always wear suitable clothing, protective gloves, and stout shoes.

Always ensure that you have a secure foothold whilst working.

Do not work on slippery underground.

2. OPERATION



DANGER! Risk of injury!

Cut injury when the product starts accidentally.

→ Wait for the blade to stop and slide the protective cover over the blade before you transport the product.

To charge the battery [Fig. O1]:



CAUTION!

Overvoltage damages the battery and the charging power supply.

→ Make sure that you use the correct mains voltage.

Before you use the battery the first time, the battery must be completely charged.

The lithium-ion battery can be charged in any state of charge and the charging process can be disconnected at any time without to damage the battery (no memory effect).

1. Connect the charging power supply  into a mains socket.

The power LED  illuminates red.



2. Connect the battery charger cable  to the charging socket .

When the charging control lamp  at the charging socket flashes green, the battery is being charged.

When the charging control lamp  at the charging socket illuminates green, the battery is completely charged

(Charging time, see 6. TECHNICAL DATA).

3. Examine the charge status regularly while you charge.

4. When the battery is completely charged, disconnect the battery charger cable  from the charging socket .

5. Disconnect the charging power supply  from the mains.

Work positions:

The hedge trimmer can be operated in 3 positions.

– Side trimming [Fig. O2]

– High trimming [Fig. O3]

– Low trimming [Fig. O4]

To start the hedge trimmer [Fig. O5]:



DANGER! Risk of injury!



Risk of injury if the product does not stop when you release the start levers.



→ Do not bypass the safety devices or switches. For example do not attach the start levers to the handle.

To start:

The product is provided with a two-handed safety device (2 start levers with starting lockout) to prevent the product from being turned on by accident.

1. Remove the protective cover from the blade.

2. Hold the front handle  with one hand and push the front start lever .

3. Hold the main handle  with the other hand, push the starting lockout  forward and pull the rear start lever .

The hedge trimmer starts.

4. Release the starting lockout  again.

To stop:

1. Release the two start levers /.

The hedge trimmer stops.

2. Wait for the blade to stop and slide the protective cover over the blade.

3. MAINTENANCE



DANGER! Risk of injury!

Cut injury when the product starts accidentally.

→ Wait for the blade to stop and slide the protective cover over the blade before you maintain the product.

To clean the Hedge Trimmer [Fig. M1]:



DANGER! Risk of injury!

Risk of injury and risk of damage to the product.

→ Do not clean the product with water or with a water jet (in particular high-pressure water jet).

→ Do not clean with chemicals including petrol or solvents. Some can destroy critical plastic parts.

The airflow slots must always be clean.

1. Clean the product with a damp cloth.

2. Clean the airflow slots  with a soft brush (do not use a screwdriver).

3. Spray the blade with the **GARDENA Cleaning Spray, Art. 2366**.
Avoid contact of the oil with the plastic parts.

To clean the charging power supply:

Make sure that the contacts of the charging socket and the charging power supply always are clean and dry before you connect the charging power supply.

Do not use running water.

→ Clean the contacts and the plastic parts with a soft and dry cloth.

4. STORAGE

To put into storage:

The product must be stored away from children.

1. Charge the battery.
2. Clean the hedge trimmer and the charging power supply (see 3. MAINTENANCE).
3. Store the hedge trimmer and the charging power supply in a dry, enclosed and frost-free place.

Disposal:

(in accordance with RL2012/19/EC)

The product must not be disposed of to normal household waste. It must be disposed of in line with local environmental regulations.

The GARDENA battery contains lithium-ion cells that should not be disposed of with normal household waste at the end of its life.



IMPORTANT!

→ Dispose of the product through or via your municipal recycling collection centre.



5. TROUBLESHOOTING



DANGER! Risk of injury!

Cut injury when the product starts accidentally.

→ Wait for the blade to stop and slide the protective cover over the blade before you troubleshoot the product.

Problem	Possible Cause	Remedy
Hedge is not cleanly cut	Blade is blunt or damaged.	→ Let the blade be replaced by the GARDENA Service.
Hedge trimmer does not start. Charging control lamp  flashes green	Under voltage.	→ Charge the battery.
Hedge trimmer does not start. Charging control lamp  flashes red	Battery overload.	→ Release the start levers. Start again.
	Blade is blocked.	→ Remove the obstacle. Start again.
	Battery temperature is out of range.	→ Use the battery in surroundings where temperatures are between 0 °C and 40 °C.
Power LED  on the charging power supply does not illuminate	Charging power supply is not plugged in correctly.	→ Plug the charging power supply into a wall outlet.



NOTE: For any other malfunctions please contact the GARDENA service department. Repairs must only be done by GARDENA service departments or specialist dealers approved by GARDENA.

6. TECHNICAL DATA

Battery Hedge Trimmer	Unit	Value (Art. 9836)
Strokes	1/min	2400
Length of blade	cm	40
Tooth gap of blade	mm	16
Weight	kg	2.2
Sound pressure level L_{pA} ¹⁾ Uncertainty k_{pA}	dB(A)	75 3
Sound power level L_{WA} ²⁾ : measured/guaranteed Uncertainty k_{WA}	dB(A)	85 / 91 6

Battery Hedge Trimmer	Unit	Value (Art. 9836)
Hand/arm vibration a_{whw} ¹⁾ Uncertainty k_a	m/s ²	< 2.5 1.5

Measuring process complying with: ¹⁾ EN 60745-2-15 ²⁾ RL 2000/14/EC



NOTE: The stated vibration emission value has been measured according to a standardized test procedure and can be used for comparison of one electric power tool with another. It can also be used for preliminary evaluation of exposure. The vibration emission value can vary during actual use of the electric power tool.

Battery	Unit	Value
Battery voltage	V (DC)	14.4
Battery capacity	Ah	2.0
Battery charging time 80% / 100% (approx.)	min.	160 / 200

Charging Power Supply	Unit	Value (Art. 9836-00.610.00 EU, 9836-28.610.00 UK)
Mains voltage	V (AC)	100 – 240
Mains frequency	Hz	50 – 60
Rated Power	W	15
Output voltage	V (DC)	18.5
Max. output current	mA	600

7. ACCESSORIES

GARDENA Charging Power Supply	Charger to charge the internal batteries.	Art. 9836-00.610.00 EU, 9836-28.610.00 UK
GARDENA Cleaning Spray	Extends the life of the blade and the battery idling time.	Art. 2366

8. SERVICE/WARRANTY

Service:

Please contact the address on the back page.

Warranty statement:

In the event of a warranty claim, no charge is levied to you for the services provided.

GARDENA Manufacturing GmbH grants a warranty for all original GARDENA new products for two years from the date of original purchase from the retailer, provided that the devices have been for private use only. This manufacturer's warranty does not apply to products acquired second hand. This warranty includes all significant defects of the product that can be proved to be material or manufacturing faults. This warranty is fulfilled by supplying a fully functional replacement product or by repairing the faulty product sent to us free of charge; we reserve the right to choose between these options. This service is subject to the following provisions:

- The product has been used for its intended purpose as per the recommendations in the operating instructions.
- Neither the purchaser nor a third party has attempted to open or repair the product.
- Only Original GARDENA replacement parts and wear parts have been used for operation.
- Presentation of the receipt.

Normal wear and tear of parts and components (such as blades, blade fixing parts, turbines, light bulbs, V-belts/toothed belts, impellers, air filters, spark plugs), visual changes, wear parts and consumables are excluded from the warranty.

This manufacturer's warranty is limited to replacement and repair of products in accordance with the abovementioned conditions. The manufacturer's warranty does not constitute an entitlement to lodge other claims against us as a manufacturer, such as for damages. This manufacturer's warranty does **not**, of course, affect statutory and contractual warranty claims against the dealer/retailer.

The manufacturer's warranty is governed by the law of the Federal Republic of Germany.

In case of a warranty claim, please return the faulty product, together with a copy of the receipt and a description of the fault, with postage paid to the service address.

Consumables:

The blade and excentric drive are consumables and are not included in the warranty.

Deutschland / Germany
GARDENA
Manufacturing GmbH
Central Service
Hans-Lorenser-Straße 40
D-89079 Ulm
Produktfragen:
(+49) 731 490-123
Reparaturen:
(+49) 731 490-290
service@gardena.com

Albania
COBALT Sh.p.k.
Rr. Siri Kodra
1000 Tirana

Argentina
Husqvarna Argentina S.A.
Av.del Libertador 5954 –
Piso 11 – Torre B
(C1428ARP) Buenos Aires
Phone: (+54) 11 5194 5000
info.gardena@
ar.husqvarna.com

Armenia
Garden Land Ltd.
61 Tigran Mets
0005 Yerevan

Australia
Husqvarna Australia Pty. Ltd.
Locked Bag 5
Central Coast BC
NSW 2252
Phone: (+61) (0) 2 4352 7400
customer.service@
husqvarna.com.au

Austria / Österreich
Husqvarna Austria GmbH
Industriezeile 36
4010 Linz
Tel.: (+43) 732 77 01 01-485
service.gardena@
husqvarnagroup.com

Azerbaijan
Firm Progress
a. Aliyev Str. 26A
1052 Baku

Belgium
Husqvarna België nv/sa
Gardena Division
Rue Egide Van Ophem 111
1180 Uccle / Ukkel
Tel.: (+32) 2 720 92 12
info@gardena.be

Bosnia / Herzegovina
SILK TRADE d.o.o.
Industrijska zona Bukva bb
74260 Tešanj

Brazil
Husqvarna do Brasil Ltda
Av. Francisco Matarazzo,
1400 – 19º andar
São Paulo – SP
CÉP: 05001-903
Tel: 0800-112252
marketing.br.husqvarna@
husqvarna.com.br

Bulgaria
AGROLAND България АД
бул. 8 Декември, №13
Офис 5
1700 Студентски град
София
Тел.: (+359) 24 66 69 10
info@agroland.eu

Canada / USA
GARDENA Canada Ltd.
100 Summerlea Road
Brampton, Ontario L6T 4X3
Phone: (+1) 905 792 93 30
info@gardenacanada.com

Chile
Maquinarias Agroforestales
Ltda. (Maga Ltda.)
Santiago, Chile
Avda. Chesterton
8355 comuna Las Condes
Phone: (+56) 2 202 4417
Dalton@maga.cl
Zipcode: 7560330

China
Husqvarna (Shanghai)
Management Co., Ltd.
富世华 (上海) 管理有限公司
3F, Benq Square B,
No207, Song Hong Rd.,
Chang Ning District,
Shanghai, PRC. 200335
上海市市长宁区淞虹路207号明
基广场B座3楼, 邮编: 200335

Colombia
Husqvarna Colombia S.A.
Calle 18 No. 68 D-31, zona
Industrial de Montevideo
Bogotá, Cundinamarca
Tel. 571 2922700 ext. 105
jairo.salazar@
husqvarna.com.co

Costa Rica
Compania Exim
Euroberoamericana S.A.
Los Colegios, Moravia,
200 metros al Sur del Colegio
Saint Francis – San José
Exim: (+506) 297 68 83
exim_euro@racsa.co.cr

Croatia
Husqvarna Austria GmbH
Industriezeile 36
4010 Linz
Tel.: (+43) 732 77 01 01-485
service.gardena@
husqvarnagroup.com

Cyprus
Med Marketing
17 Digeni Akrita Ave
P.O. Box 27017
1641 Nicosia

Czech Republic
Husqvarna Česko s.r.o.
Türkova 2319/5b
149 00 Praha 4 – Chodov
Bezplatná infolinka:
800 100 425
servis@cz.husqvarna.com

Denmark
GARDENA DANMARK
Lejrvej 19, st.
3500 Værløse
Tlf.: (+45) 70 26 47 70
husqvarna@husqvarna.dk
www.gardena.com/dk

Dominican Republic
BOSQUESA, S.R.L
Carretera Santiago Licey
Km. 5 ½
Esquina Copal II.
Santiago
Dominican Republic
Phone: (+809) 736-0333
joserbosquesa@claro.net.do

Ecuador
Husqvarna Ecuador S.A.
Arupos E1-181 y 10 de
Agosto Quito, Pichincha
Tel. (+593) 22800739
francisco.jacome@
husqvarna.com.ec

Estonia
Husqvarna Eesti OÜ
Valdeku 132
EE-11216 Tallinn
info@gardena.ee

Finland
Oy Husqvarna Ab
Gardena Division
Lautatarhankatu 8 B/ PL 3
00581 HELSINKI
www.gardena.fi

France
Husqvarna France
9/11 Allée des pierres mayettes
92635 Gennevilliers Cedex
France
http://www.gardena.com/fr
N° AZUR: 0 810 00 78 23
(Prix d'un appel local)

Georgia
Transporter LLC
8/57 Beliashvili street
0159 Tbilisi, Georgia
Phone: (+995) 322 14 71 71

Great Britain
Husqvarna UK Ltd
Preston Road
Aycliffe Industrial Park
Newton Aycliffe
County Durham
DL5 6UP
info.gardena@
husqvarna.co.uk

Greece
Π. ΠΑΠΑΔΟΠΟΥΛΟΣ ΑΕΒΕ
Λεωφ. Αθηνών 92
Αθήνα
T.K.104 42
Ελλάδα
Τηλ. (+30) 210 51 93 100
info@papadopoulos.com.gr

Hungary
Husqvarna Magyarország Kft.
Ezred u. 1-3
1044 Budapest
Telefon: (+36) 1 251-4161
vevoszolgalat.husqvarna@
husqvarna.hu

Iceland
Ó. Johnson & Kaaber
Tunguhalsi 1
110 Reykjavik
ooj@ojk.is

Ireland
Husqvarna UK Ltd
Preston Road
Aycliffe Industrial Park
Newton Aycliffe
County Durham
DL5 6UP
info.gardena@
husqvarna.co.uk

Italy
Husqvarna Italia S.p.A.
Via Santa Vecchia 15
23868 VALMADRERA (LC)
Phone: (+39) 0341.203.111
assistenza.italia@
it.husqvarna.com

Japan
KAKUICHI Co. Ltd.
Sumitomo Realty &
Development Kojimachi
BLDG., 8F
5-1 Nibannco
Chiyoda-ku
Tokyo 102-0084
Phone: (+81) 33 264 4721
m_ishihara@kaku-ichi.co.jp

Kazakhstan
LAMED Ltd.
155/1, Tazhibayevoi Str.
050060 Almaty
IP Schmidt
Abayavenue 3B
110 005 Kostanay

Korea
Kyung Jin Trading CO.,LTD.
107-4, SunDuk Bld.,
YangJae-dong,
Seocho-gu,
Seoul, (zipcode: 137-891)
Phone: (+82) (0)2 574-6300

Kyrgyzstan
Alye Maki
av. Moladaya Guardir J 3
720014
Bishkek

Latvia
Husqvarna Latvija SIA
Ulbrokas 19A
LV-1021 Rīga
info@gardena.lv

Lithuania
UAB Husqvarna Lietuva
Ateities pl. 77C
LT-52104 Kaunas
info@gardena.lt

Luxembourg
Magasins Jules Neuberger
39, rue Jacques Stas
Luxembourg-Gasperich 2549
Case Postale No. 12
Luxembourg 2010
Phone: (+352) 40 14 01
api@neuberger.lu

Mexico
AFOSA
Av. Lopez Mateos Sur # 5019
Col. La Calma 45070
Zapopan, Jalisco
Mexico
Phone: (+52) 33 3818-3434
icornejo@afosa.com.mx

Moldova
Convel S.R.L.
290A Muncesti Str.
2002 Chisinau

Netherlands
Husqvarna Nederland B.V.
GARDENA Division
Postbus 50131
1305 AC ALMERE
Phone: (+31) 36 521 00 10
info@gardena.nl

Neth. Antilles
Jonka Enterprises N.V.
Sta. Rosa Weg 196
P.O. Box 8200
Curaçao
Phone: (+599) 9 767 66 55
pgm@jonka.com

New Zealand
Husqvarna New Zealand Ltd.
PO Box 76-437
Manukau City 2241
Phone: (+64) (0) 9 9202410
support.nz@husqvarna.co.nz

Norway
Husqvarna Norge AS
Gardena Division
Trøskenveien 36
1708 Sarpsborg
info@gardena.no

Peru
Husqvarna Perú S.A.
Jr. Ramón Cárcamo 710
Lima 1
Tel: (+51) 1 3320400 ext. 416
juan.remuzgo@
husqvarna.com

Poland
Husqvarna
Poland Spółka z o.o.
ul. Wysockiego 15 b
03-371 Warszawa
Phone: (+48) 22 330 96 00
gardena@husqvarna.com.pl

Portugal
Husqvarna Portugal, SA
Lagoa - Albarraque
2635 - 595 Rio de Mouro
Tel.: (+351) 21 922 85 30
Fax : (+351) 21 922 85 36
info@gardena.pt

Romania
Madex International Srl
Soseaua Odaii 117- 123,
RO 013603 Bucureşti, S1
Phone: (+40) 21 352.76.03
madex@ines.ro

Russia / Россия
ООО „Хускварна“
141400, Московская обл.,
г. Химки,
улица Ленинградская,
владение 39, стр.6
Бизнес Центр
„Химки Бизнес Парк“,
помещение ОВ02_04
http://www.gardena.ru

Serbia
Domel d.o.o.
Autoput za Novi Sad bb
11 273 Belgrade
Phone: (+381) 1 18 48 88 12
miroslav.jejina@domel.rs

Singapore
Hy-Ray PRIVATE LIMITED
40 Jalan Pemimpin
#02-08 Tat Ann Building
Singapore 577185
Phone: (+65) 6253 2277
shiyiing@hyray.com.sg

Slovak Republic
Husqvarna Česko s.r.o.
Türkova 2319/5b
149 00 Praha 4 – Chodov
Bezplatná infolinka:
800 154 044
servis@sk.husqvarna.com

Slovenia
Husqvarna Austria GmbH
Industriezeile 36
4010 Linz
Tel.: (+43) 732 77 01 01-485
service.gardena@
husqvarnagroup.com

South Africa
Husqvarna
South Africa (Pty) Ltd
Postnet Suite 250
Private Bag X6,
Cascades, 3202
South Africa
Phone: (+27) 33 846 9700
info@gardena.co.za

Spain
Husqvarna España S.A.
Calle de Rivas nº 10
28052 Madrid
Phone: (+34) 91 708 05 00
atencioncliente@gardena.es

Suriname
Agrofrix n.v.
Verlengde Hogestraat #22
Phone: (+597) 472426
agrofrix@sr.net
Pobox : 2006
Paramaribo
Suriname – South America

Sweden
Husqvarna AB
Gardena Division
S-561 82 Husqvarna
Gardenaorder@husqvarna.se

Switzerland / Schweiz
Husqvarna Schweiz AG
Consumer Products
Industriestrasse 10
5506 Mägenwil
Phone: (+41) (0) 62 887 37 90
info@gardena.ch

Turkey
Dost Bahçe Diş Ticaret
Müessesilik A.Ş
Yunus Mah. Adil Sok. No:3
Ic Kapi No: 1 Kartal
34873 Istanbul
Phone: (+90) 216 38 93 939
info@dostbahce.com.tr

Ukraine / Україна
ТОВ «Хускварна Україна»
вул. Васильківська, 34,
офіс 204-г
03022, м. Київ
Тел. (+38) 044 498 39 02
info@gardena.ua

Uruguay
FELI SA
Entre Rios 1083 CP 11800
Montevideo – Uruguay
Tel: (+598) 22 03 18 44
info@felisa.com.uy

Venezuela
Corporación Casa y Jardín C.A.
Av. Caroní, Edif. Trezmen, PB.
Colidas de Bello Monte.
1050 Caracas.
Tlf: (+58) 212 992 33 22
info@casayjardin.net.ve

9836-20.960.02/0919
© GARDENA
Manufacturing GmbH
D-89070 Ulm
http://www.gardena.com