

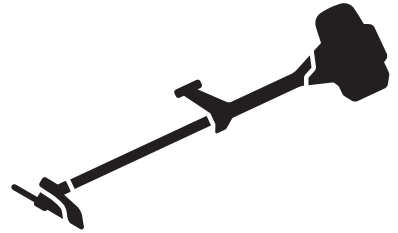

Husqvarna[®]



535RX, 535RXT

Contents

Introduction.....	2	Troubleshooting.....	27
Safety.....	4	Transportation, storage and disposal.....	28
Assembly.....	10	Technical data.....	28
Operation.....	14	Accessories.....	29
Maintenance.....	21	Warranty.....	31

Introduction

Product overview

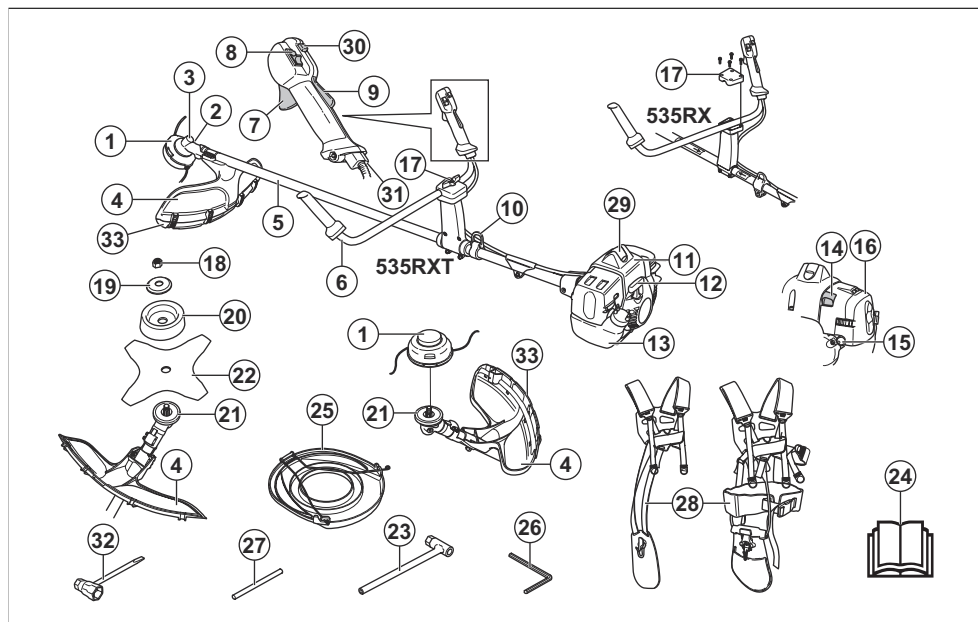

- | | |
|----------------------------------|-----------------------------------|
| 1. Trimmer head | 16. Air filter cover |
| 2. Grease filler cap, bevel gear | 17. Handle adjustment |
| 3. Bevel gear | 18. Locknut |
| 4. Cutting attachment guard | 19. Support flange |
| 5. Shaft | 20. Support cup |
| 6. Handlebar | 21. Drive disc |
| 7. Throttle control | 22. Blade |
| 8. Stop switch | 23. Socket wrench |
| 9. Throttle lockout | 24. Operator's manual |
| 10. Suspension ring | 25. Transport guard |
| 11. Cylinder cover | 26. Hex key |
| 12. Starter rope handle | 27. Locking pin |
| 13. Fuel tank | 28. Harness |
| 14. Choke control | 29. Spark plug cap and spark plug |
| 15. Air purge bulb | 30. Start throttle button |

- 31. Throttle wire adjustment
- 32. Spark plug wrench
- 33. Guard extension

Product description

This product is a brushcutter with a combustion engine.

Work is constantly in progress to increase your safety and efficiency during operation. Speak to your servicing dealer for more information.

Intended use

Use the product with a saw blade, a grass blade or a trimmer head to cut different types of vegetation. Do not use the product for other tasks than grass trimming, grass clearing and forestry clearing. Use a saw blade to cut fibrous types of wood. Use a grass blade or trimmer head to cut grass.

Note: National or local regulations can regulate the use. Comply to given regulations.

Only use the product with accessories that are approved by the manufacturer. Refer to *Accessories on page 29*.

Symbols on the product



WARNING! This product is dangerous. Injury or death can occur to the operator or bystanders if the product is not used carefully and correctly. To prevent injury to the operator or bystanders, read and obey all safety instructions in the operator's manual.



Read the operator's manual carefully and make sure that you understand the instructions before use.



Use a protective helmet in locations where objects can fall on you. Use approved hearing protection. Use approved eye protection.



Use approved protective gloves.



Use heavy-duty slip-resistant boots.



The product can cause objects to eject, which can cause injury.



Maximum speed of the output shaft.



Keep a minimum distance of 15 m/50 ft to persons and animals during operation of the product.



Risk of blade thrust if the cutting equipment touches an object that it does not immediately cut. The product can cut off body parts. Keep a minimum of 15 m/50 ft distance to persons and animals during operation of the product.



Air purge bulb.



Fill fuel.



Sound power level.

yyyywwxxxx

The rating plate shows the serial number. **yyyy** is the production year, **ww** is the production week.

Note: Other symbols/decals on the product refer to certification requirements for other commercial areas.

EPA III

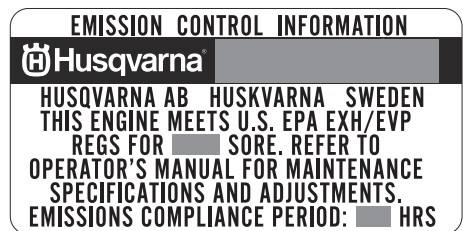

The Emissions Compliance Period referred to on the Emission Compliance label indicates the number of operating hours for which the engine has been shown to meet Federal emissions requirement. Maintenance, replacement or repair of the emission control devices and system may be performed by any nonroad engine repair establishment or individual.

EMISSION CONTROL LABEL ABBREVIATIONS

General					
CAL	California	EVAP	Evaporative	REGS	Regulations
DISPL	Displacement	EXH/EVP	Exhaust and Evaporative	SORE	Small off road engines
ECS	Emission control system	HRS	Hours	US EPA	United States Environmental Protection Agency
Exhaust emission control systems					
ECM	Engine control module (Autotune)	OC	Oxidizing Catalyst		
EM	Engine modification	TWC	Three way catalyst		
Evaporative emission control systems					
C	Coextruded (Multilayer)	P	Treated HDPE or PE		
N	Nylon	S	Sealed		

California Proposition 65

WARNING!

The engine exhaust from this product contains chemicals known to the State of California to cause cancer, birth defects or other reproductive harm.

Product liability

As referred to in the product liability laws, we are not liable for damages that our product causes if:

- the product is incorrectly repaired.
- the product is repaired with parts that are not from the manufacturer or not approved by the manufacturer.
- the product has an accessory that is not from the manufacturer or not approved by the manufacturer.
- the product is not repaired at an approved service center or by an approved authority.

Safety

Safety definitions

Warnings, cautions and notes are used to point out specially important parts of the manual.



WARNING: Used if there is a risk of injury or death for the operator or bystanders if the instructions in the manual are not obeyed.



CAUTION: Used if there is a risk of damage to the product, other materials or the adjacent area if the instructions in the manual are not obeyed.

Note: Used to give more information that is necessary in a given situation.

General safety instructions



WARNING: Read the warning instructions that follow before you use the product.

- This product produces an electromagnetic field during operation. This field may under some circumstances interfere with active or passive medical implants. To reduce the risk of serious or fatal injury we recommend persons with medical implants to consult their physician and the medical implant manufacturer before operating this product.
- Do not use the product if you are tired, ill, or under the influence of alcohol, drugs or medicine. This has a negative effect on your vision, alertness, coordination and judgment.

- Do not operate the product in bad weather, such as dense fog, heavy rain, strong wind and intense cold. To operate the product in bad weather can make you tired and add risks, such as icy ground and unpredictable felling direction.
- Always be careful and use your common sense. If you feel uncertain about a work situation or the operating procedures after you read the operator's manual, speak to a servicing dealer before you continue.
- Remove the spark plug cap if you let the product out of view.
- A used muffler/spark arrester and spark arrester mounting face may contain deposits of combustion particles that may be carcinogenic. Avoid being exposed to these compounds when handling the muffler and/or spark arrester. Prior to any handling of the muffler and/or the spark arrester, refer to *To do a check of the muffler on page 8*.
- Listen for warning signals and loud voices when you use hearing protection. Always remove your hearing protection when the engine stops.
- Never use the product if it is changed or damaged.
- Make sure that the spark plug cap and ignition lead are not damaged to prevent the risk of electrical shock.
- Look around the work area to make sure that no persons, animals or objects have a negative effect on the safety of the operation of the product.
- Look around the work area to make sure that no persons or animals touch the cutting attachment or are hit by objects that are ejected from the cutting attachment.
- Do not use the product in a situation or location where you can not get aid if an accident occurs.
- Do not use the product without an approved cutting attachment guard.
- Make sure that persons or animals keep a distance of a minimum of 15 m/50 ft during work. Always look behind you before you turn around with the product. Stop the product immediately if a person or animal enters the 15 m/50 ft safety zone. If more than 1 operator does work in the same area, keep a safety distance of a minimum of 2 times the tree height and a minimum of 15 m/50 ft.

Safety instructions for assembly



WARNING: Read the warning instructions that follow before you use the product.

- Use approved protective gloves when you assemble the product and cutting attachment.
- Remove the spark plug cap from the spark plug before you assemble the product.
- Make sure that the correct handlebar and cutting attachment guard are assembled before you operate the product.
- A damaged or incorrect cutting attachment guard can cause injury. Do not use a cutting attachment without an approved cutting attachment guard.
- Attach the clutch cover and shaft correctly before you start the product.
- The drive disc and support flange must engage correctly in the center hole of the cutting attachment. A cutting attachment that is attached incorrectly can cause injury or death.
- Attach the harness to the product to prevent injury to the operator or others.
- Examine the work area. Avoid loose objects, such as stones, broken glass, nails, steel wire and string, that can eject or wind around the cutting attachment.
- Make sure that you can move safely and have a safe stance. Examine the area around you for obstacles such as roots, rocks, branch and ditches. Be careful during work on slopes.

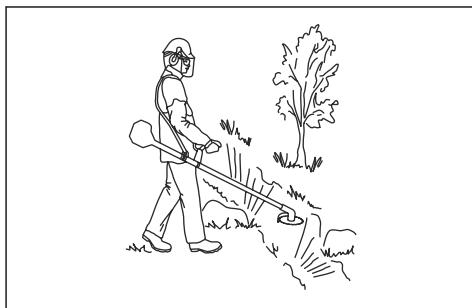

Safety instructions for operation



WARNING: Read the warning instructions that follow before you use the product.

- Learn and understand the difference between forestry clearing, grass clearing and grass trimming before you use the product.
- Use personal protective equipment, refer to *Personal protective equipment on page 6*.
- Long-term exposure to noise can result in permanent hearing loss. Always use approved hearing protection.
- Do not overreach. Keep a stable position of the feet and a good balance at all times.
- Before you start the product, put it on a flat surface, at a minimum of 3 m/10 ft from the fuel source and from where you fill fuel. Make sure that there are no objects near or touching the cutting attachment.
- If the cutting attachment rotates at idle speed, let a service agent adjust it. Do not use the product until it is adjusted or repaired.
- Look out for thrown objects. Always use approved eye protection and keep away from the cutting attachment guard. Stones and other small objects

can eject into your eyes and cause blindness or other injuries.

- Do not put the product down with the engine on unless you have it in clear view.
- Do not remove the cut material, or let other persons remove cut material, while the engine is on or the cutting equipment rotates, as this can result in serious injury.
- Always stop the engine and make sure that the cutting equipment does not rotate before you remove material that is wound around the blade shaft or caught between the cutting attachment guard and the cutting attachment.
- Be careful when you remove material from around the cutting equipment. The bevel gear gets hot during operation and can cause burn injuries.
- The exhaust fumes from the engine are hot and can contain sparks. Risk of fire. Be careful around dry and flammable material.
- Never use the product indoors or in spaces lacking proper ventilation. Exhaust fumes contain carbon monoxide, an odourless, poisonous and highly dangerous gas.
- Stop the engine before you move to a new work area. Always attach the transport guard before you move the equipment.
- Overexposure to vibration can lead to circulatory damage or nerve damage in persons who have poor circulation. Speak to your physician if you experience symptoms of overexposure to vibration. Such symptoms include numbness, loss of feeling, tingling, pricking, pain, loss of strength, changes in skin colour or condition. These symptoms usually show in the fingers, hands or wrists. The risk increases at low temperatures.

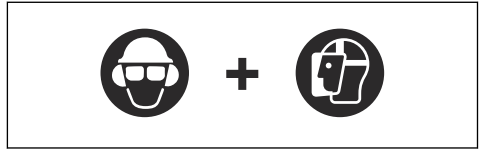

- Use gloves when it is necessary, for example when you attach, examine or clean the cutting equipment.
- Use protective boots with steel toe-cap and non-slip soles.
- Use clothing made of a strong fabric. Always use heavy, long pants and long sleeves. Do not use loose clothing that can catch on twigs and branches. Do not use jewelry, short pants or sandals. Do not go with bare feet. Put your hair up safely above shoulder level.



- Keep first aid equipment near.

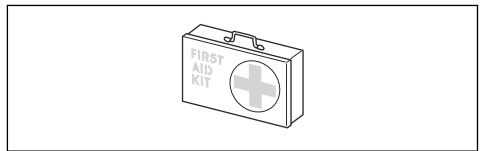

Safety devices on the product

For information about where to find the safety devices, see *Safety instructions for assembly on page 5*.



WARNING: Read the warning instructions that follow before you use the product.

- Do not use a product with damaged safety devices. Do a check of and do maintenance on the safety devices regularly. If the safety devices are damaged, speak to your Husqvarna service agent.
- Do not make changes to safety devices. Do not use the product if protective covers, safety switches or other protective devices are not attached or are damaged.
- For all service and repair work on the product, especially for the safety devices, special training is necessary. If the safety devices fail the checks given in this operator's manual, you must let a service agent help you. We guarantee that professional repairs and service is available. If your dealer is not a service agent, speak to them for information about the nearest service agent.
- Do not use a cutting attachment without an approved and correctly attached cutting attachment guard. See *To assemble the cutting equipment on page 11*.

Personal protective equipment



WARNING: Read the warning instructions that follow before you use the product.

- Always use approved personal protective equipment when you use the product. Personal protective equipment cannot fully prevent injury but it decreases the degree of injury if an accident does occur. Let your dealer help you select the correct equipment.
- Use a helmet if the trees in the work area have a height of more than 2 m/6.5 ft.
- Use approved hearing protection.
- Always use approved protective goggles that comply with ANSI Z87.1 standard in the USA or EN 166 in EU countries. Use visor for face protection. Visor is not enough to protect the eyes.

Cutting attachment



WARNING: The cutting attachment must not rotate when you do work on it. Make sure that the engine has stopped. Remove the spark plug cap before you do work on the cutting attachment.



WARNING: Make sure that the cutting attachment is not damaged. A damaged cutting attachment can cause accidents. Replace a damaged cutting attachment.



WARNING: Use the correct cutting attachment. Only use the cutting attachment with the guards we recommend, refer to *Accessories on page 29*.

To do a check of the throttle trigger lockout

1. Make sure that the throttle trigger lockout (A) and throttle trigger (B) move freely and that the return spring works correctly.

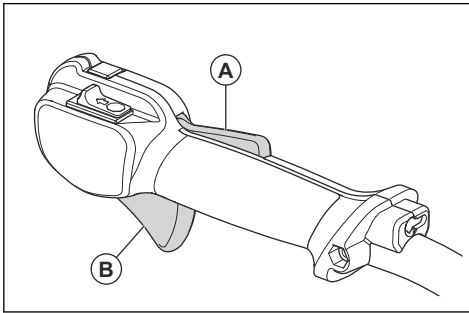

2. Push down the throttle trigger lockout and make sure that it goes back to its initial position when you release it.

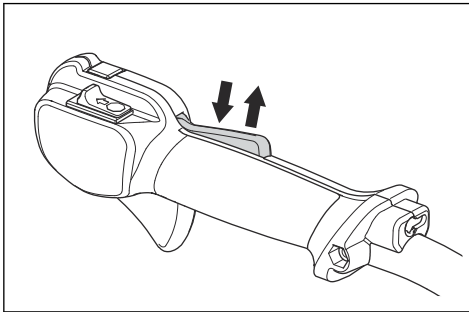

3. Make sure that the throttle trigger is locked at the idle position when the throttle trigger lockout is released.

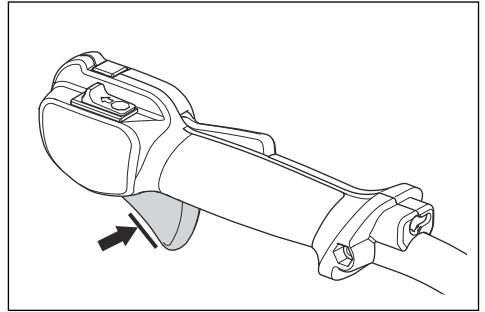

4. Start the product and apply full throttle.
5. Release the throttle trigger and make sure that the blades stop and stay stationary.



WARNING: If the blades move when the throttle trigger is in the idle position, then the carburetor idle speed must be adjusted. Refer to *To adjust the idle speed on page 26*.

Stop switch

Start the engine. Make sure that the engine stops when you move the stop switch to the stop position.

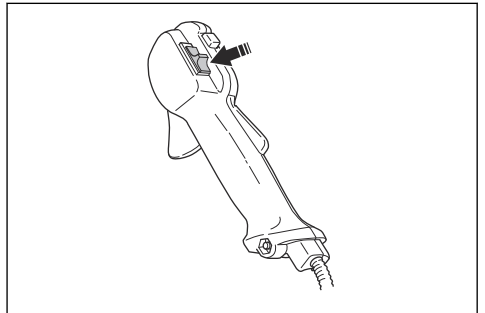

To do a check of the cutting attachment guard



WARNING: An incorrect or damaged cutting attachment guard can cause serious injury. Refer to *Safety instructions for operation on page 5*.



WARNING: Always use the recommended cutting attachment guard for the cutting attachment that you use. If an incorrect or damaged cutting attachment guard is installed, this can cause serious injury. Refer to *Technical data on page 28*.

The cutting attachment guard prevents injuries from objects that eject in the direction of the operator. It also prevents injuries that occur if you touch the cutting attachment.

1. Do a visual check for damages, for example cracks.

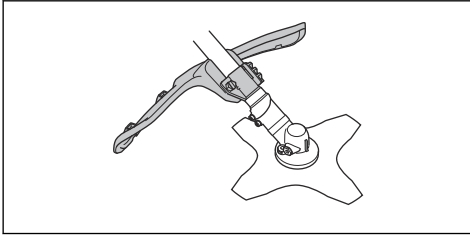

2. Replace the cutting attachment guard if it is damaged.

To do a check of the vibration damping system



WARNING: An incorrectly wound cord or an incorrect cutting attachment increases the level of vibration. Refer to *Safety instructions for operation on page 5*.

The vibration damping system decreases vibration in the handles to a minimum which makes the operation easier.

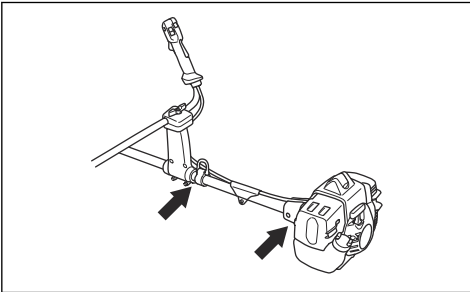

1. Stop the engine.
2. Do a visual check for deformation and damage.

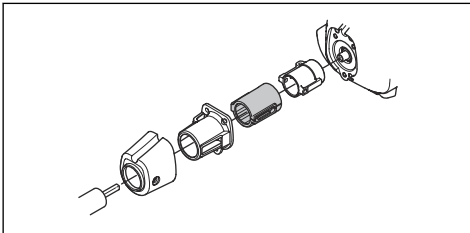

3. Make sure that the vibration damping units are correctly attached.

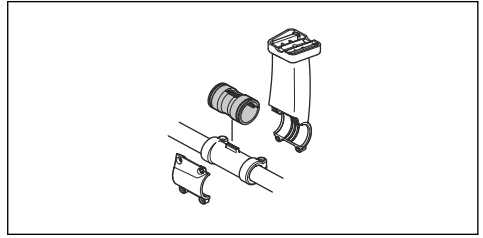

To do a check of the quick-release mechanism



WARNING: Do not use a harness with a damaged quick-release mechanism.

The quick-release mechanism lets the operator remove the product quickly from the harness if there is an emergency.

1. Stop the engine.
2. Do a visual check for damage for example, cracks.
3. Release and attach the quick-release mechanism to make sure that it operates correctly.

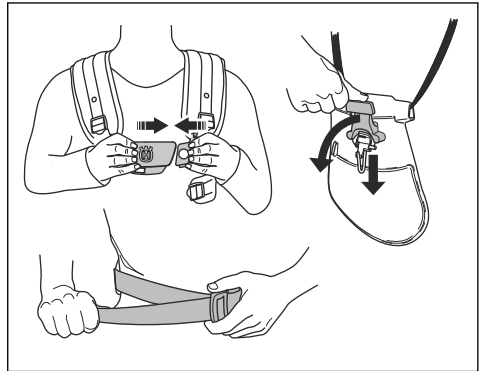

To do a check of the muffer



WARNING: Do not use a product with a damaged muffer.



WARNING: The muffer becomes very hot during and after operation and also at idle speed. Use protective gloves to prevent burn injuries.

The muffer keeps noise levels to a minimum and points exhaust fumes away from the operator.

1. Stop the engine.

2. Do a visual check for damage and deformation.

Note: The inner surfaces of the muffler contain chemicals that can cause cancer. Be careful not to touch these elements if the muffler is damaged.

3. Make sure that the muffler is correctly attached to the product.

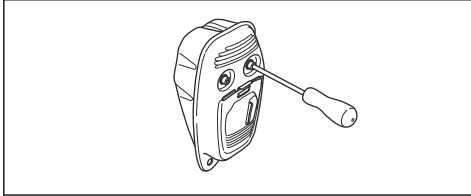

4. If the muffler on your product has a spark arrester screen, do a visual check.

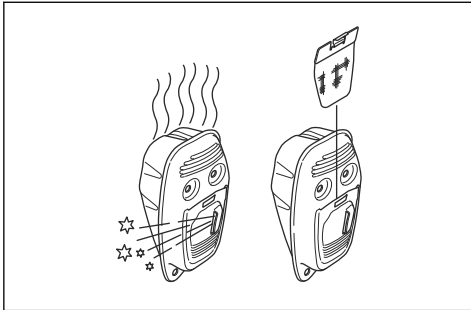

- a) Replace the spark arrester screen if it is damaged.
- b) Clean the spark arrester screen if it is blocked. Refer to *Maintenance on page 21* for more information.



CAUTION: If the spark arrester screen is blocked the product becomes too hot and this causes damage to the cylinder and piston.

Saw blade and grass blade

- Use correctly sharpened blades. An incorrectly sharpened or damaged blade increases the risk of injury.
- Use correctly set blades. Correct blade set is 1 mm. An incorrectly set blade increases the risk of injury and damage.
- To sharpen and set the blade correctly, refer to the instructions that come with the blade.

Cutting equipment

- Use the blades to cut wood.

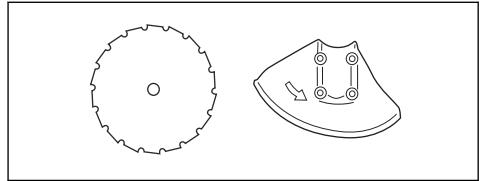

- Use the blades and grass knives to cut coarse grass.

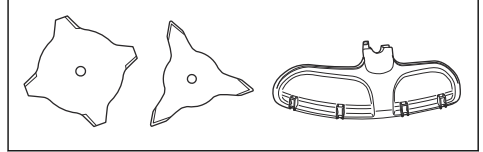

- Use the trimmer head to cut grass.

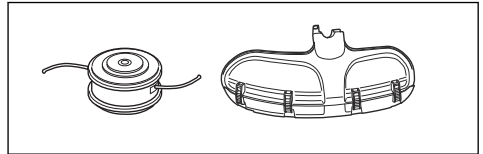

- An incorrectly sharpened or damaged blade increases the risk of accidents. Keep the teeth of the blade correctly sharpened. Follow the instructions in *To sharpen the grass knife and grass blade on page 26* and use the recommended file gauge.

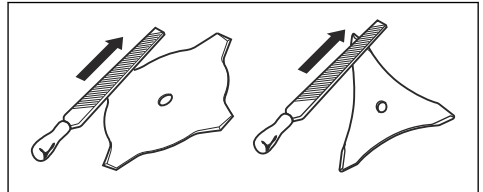

- Examine the cutting equipment for damage and cracks. Replace the cutting equipment if it is damaged.
- Only use the cutting equipment with the recommended guards. Refer to *Accessories on page 29*.

Safety instructions for maintenance



WARNING: Read the warning instructions that follow before you use the product.

- Stop the engine, make sure that the cutting attachment stops. Remove the cylinder cover and disconnect the spark plug cap before you do the maintenance.
- The exhaust fumes from the engine contain carbon monoxide, an odourless, poisonous and very dangerous gas that can cause death. Do not run the product indoors or in closed spaces.

- The exhaust fumes from the engine are hot and can contain sparks. Do not run the product indoors or near flammable material.
- Accessories and changes to the product that are not approved by the manufacturer, can cause serious injury or death. Do not change the product. Always use original accessories.
- If the maintenance is not done correctly and regularly, there is an increased risk of injury and damage to the product.
- Only do the maintenance as this operator's manual recommends. Let an approved Husqvarna service agent do all other servicing.
- Let an approved Husqvarna service agent do servicing on the product regularly.
- Replace damaged, worn or broken parts.
- Do not breathe in the fuel fumes, it can cause injury. Make sure that there is sufficient airflow.
- Do not smoke near the fuel or the engine.
- Do not put warm objects near the fuel or the engine.
- Do not add the fuel when the engine is on.
- Make sure that the engine is cool before you refuel.
- Before you refuel, open the fuel tank cap slowly and release the pressure carefully.
- Make sure there are sufficient airflow when refueling and mixing fuel (petrol and two-stroke oil) or draining the fuel tank.
- Fuel and fuel vapor are highly flammable and can cause serious injury when inhaled or allowed to come into contact with the skin. For this reason, observe caution when handling fuel and make sure there is sufficient airflow.
- Tighten the fuel tank cap carefully or a fire can occur.
- Move the product at a minimum of 3 m (10 ft) from the position where you filled the tank before a start.
- Do not put too much fuel in the fuel tank.
- Make sure that a leak cannot occur when you move the product or fuel container.
- Do not put the product or a fuel container where there is an open flame, spark or pilot light. Make sure that the storage area does not contain an open flame.
- Only use approved containers when you move the fuel or put the fuel into storage.
- Empty the fuel tank before long-term storage. Obey the local law on where to dispose fuel.
- Clean the product before long-term storage.
- Remove the spark plug cap before you put the product into storage to make sure that the engine does not start accidentally.

Fuel safety



WARNING: Read the warning instructions that follow before you use the product.

- Do not mix the fuel indoor or near a heat source.
- Do not start the product if there is fuel or engine oil on the product. Remove the unwanted fuel/oil and let the product dry. Remove unwanted fuel from the product.
- If you spill fuel on your clothing, change clothing immediately.
- Do not get fuel on your body, it can cause injury. If you get fuel on your body, use a soap and water to remove the fuel.
- Do not start the engine if you spill oil or fuel on the product or on your body.
- Do not start the product if the engine has a leak. Examine the engine for leaks regularly.
- Be careful with fuel. Fuel is flammable and the fumes are explosive and can cause injuries or death.

Assembly

Introduction



WARNING: Before you assemble the product, you must read and understand the safety chapter.



WARNING: Remove the spark plug cable from the spark plug before you assemble the product.

To assemble the throttle handle

1. Remove the screw behind the throttle handle.

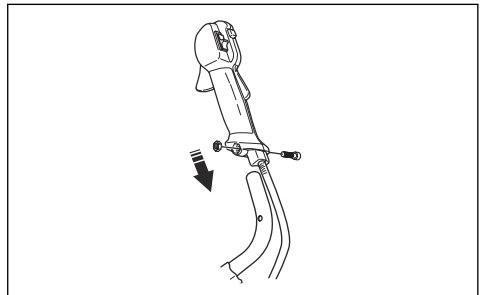

2. Move the throttle handle to the right side of the handlebar.
3. Align the hole behind the throttle handle with the hole in the handlebar.
4. Put the screw through the holes. Tighten the screw.

To assemble the handlebar

1. Put the handlebar into the bracket.

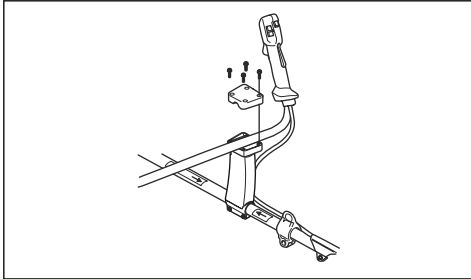

2. Make sure that the holes for the screws align.
3. Attach the 4 screws but do not tighten fully.
4. Adjust the handlebar to put the product in a good operation position.



5. Tighten the 4 screws fully.

To assemble the handlebar

1. Put the handlebar into the bracket.

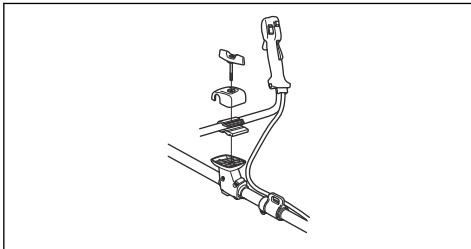

2. Make sure that the holes for the knob align.
3. Attach the knob but do not tighten fully.

4. Adjust the handlebar to put the product in a good operation position.



5. Tighten the knob fully.

To assemble the cutting equipment

The cutting equipment includes a cutting attachment and a cutting attachment guard.



WARNING: Use protective gloves.



WARNING: Always use the cutting attachment guard that is recommended for the cutting attachment. See *Accessories on page 29*.



WARNING: An incorrectly attached cutting attachment can result in injury or death.

To attach the trimmer guard or combination guard for trimmer head and plastic blades

1. Hang the trimmer guard/combination guard (A) onto the two hooks on the plate holder (M).
2. Bend the guard around the shaft and attach it with the bolt (L) on the opposite side of the shaft.
3. Put the locking pin (C) in the groove on the bolt head and tighten the bolt fully.

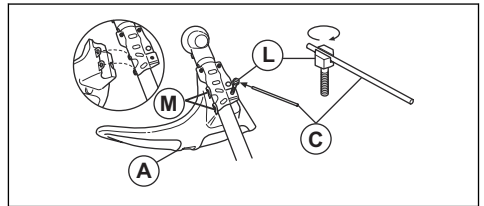

To attach a trimmer head or plastic blade

1. Put the drive disc (B) on the output shaft.
2. Align the metal cup (P) with the center of the blade guide on the drive disc.

- Turn the output shaft to align one of the holes in the drive disc with the related hole in the gear housing.
- Put the locking pin (C) in the hole to lock the shaft.
- Turn the trimmer head/plastic blades (H) counterclockwise to attach.

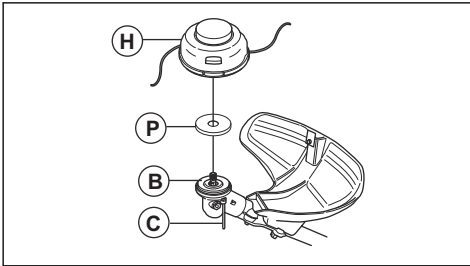

To attach the guard extension



CAUTION: Use the guard extension when you use a trimmer head/plastic blade. Do not use the guard extension when you use a grass blade.

- Put the guard extension in the groove of the cutting attachment guard.

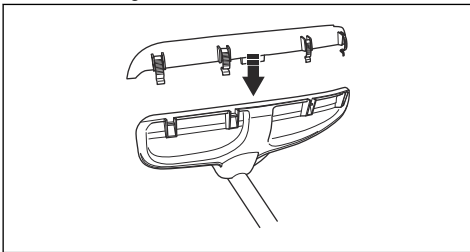

- Put the guard extension into position on the cutting attachment guard with the 4 locking hooks.

To remove the guard extension

- Release the locking hooks with the spark plug wrench.

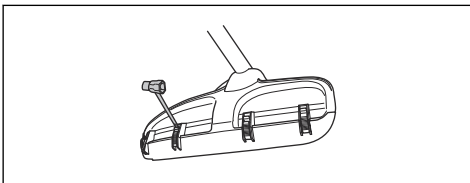

To attach the grass blade and the grass blade guard/combination guard

- Put the blade guard/combination guard (A) onto the shaft and tighten the bolt to attach it.

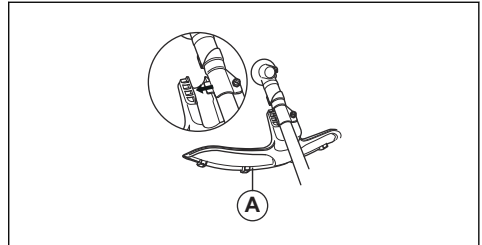

- Make sure that the guard extension is removed.
- Turn the output shaft to align one of the holes in the drive disc (B) with the related hole in the gear housing.
- Put the locking pin (C) in the hole to lock the shaft.
- Put the grass blade (D), the support cup (E) and the support flange (F) on the output shaft.

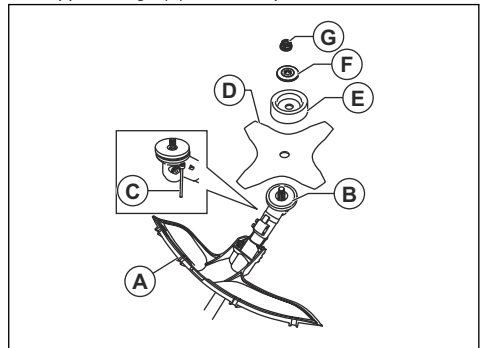

- Make sure that the drive disc and support flange engages correctly in the centre hole of the grass blade.

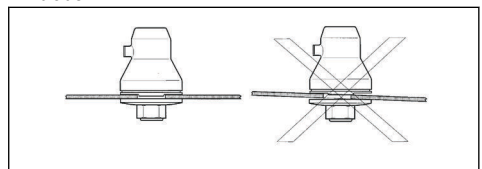

- Attach the nut (G).

8. Tighten the nut with the socket wrench. Hold the shaft of the socket wrench near the blade guard. Tighten in the opposite direction to how the cutting attachment rotates. Tighten it to a torque of 35-50 Nm.

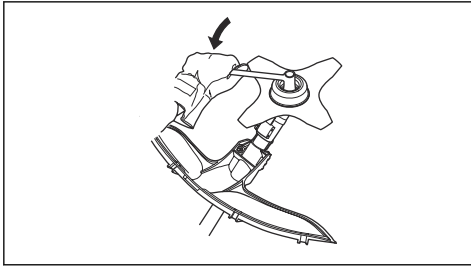

To install the saw blade



WARNING: There is a risk of injury around the saw blade nut. Make sure that the blade guard is correctly installed. Always use protective gloves.

1. Attach the drive disc (B) to the output shaft.
2. Turn the blade shaft until one of the holes in the drive disc aligns with the hole in the gear housing.
3. Put the locking pin (C) in the hole to lock the shaft.
4. Install the saw blade (D) and the support flange (F) to the output shaft.
5. Install the saw blade nut (G).

Note: The saw blade nut has a left hand thread.

6. Turn the socket wrench counterclockwise to tighten the locknut. Make sure that the torque of the locknut is 35-50 Nm (3.5-5 kpm). Hold the shaft of the socket wrench as near the blade guard as possible.

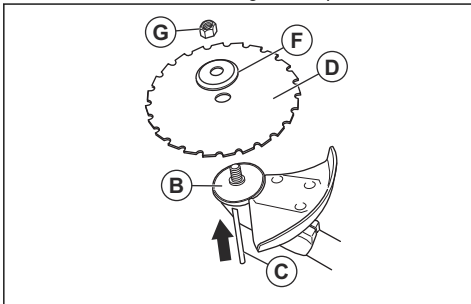

- a) Make sure that you operate the socket wrench in the identified area when you loosen or tighten the saw blade nut.

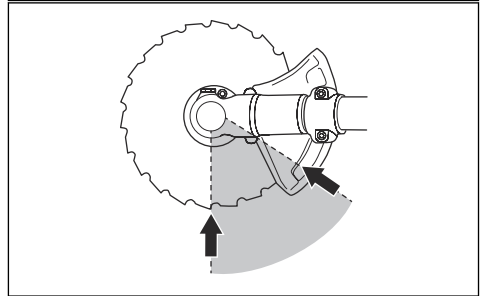
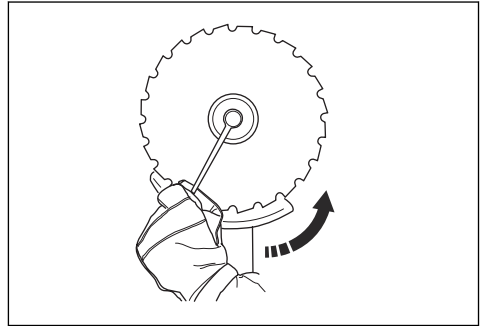

To install the blade guard



CAUTION: Only use the approved guard for the blades. Refer to *Accessories* on page 29.

1. Remove the bracket (H).
2. Attach the adapter (I) and bracket (J) with the 2 screws (K).
3. Attach the blade guard (A) to the adapter with the 4 screws (L).

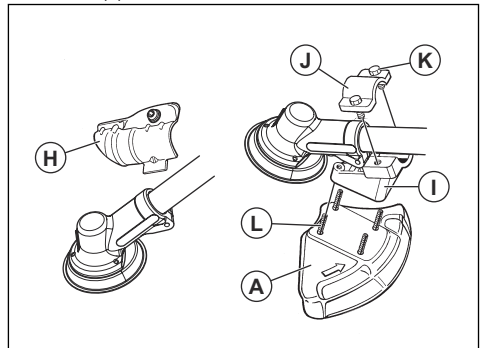

To adjust the harness

1. Put on the harness of the product.
2. Push the 2 parts of the breastplate together.

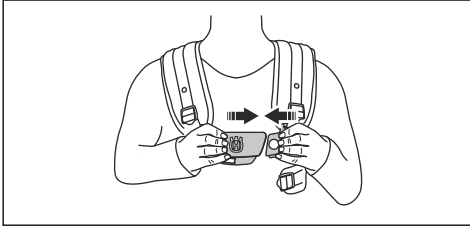

3. Tighten the hip strap tightly. Make sure that the hip strap aligns with the hip.

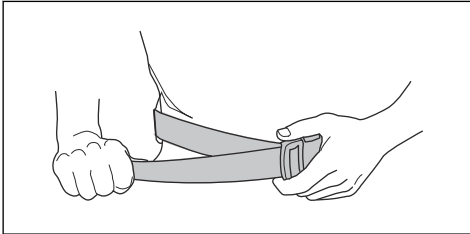

4. Tighten the chest strap below your left arm tightly. The chest strap must be tight against your body.

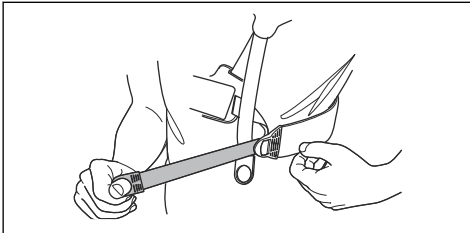

5. Adjust the shoulder strap until the weight is equal on your shoulders.

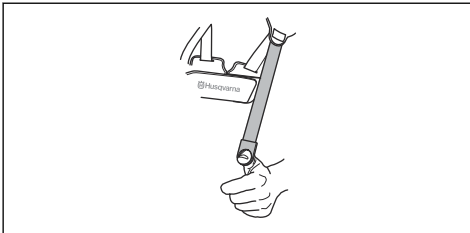

6. Adjust the height of the suspension point.
For forestry clearing, the correct height of the suspension is approximately 10 cm below your hip.
Refer to *Correct balance of the product on page 16*.

Quick release function of the harness



WARNING: Do not use the harness if the quick release function is damaged. Make sure that the quick release function operates correctly when you adjust the product.



WARNING: If the product is not safely attached to the harness, you can not control the product and that can result in injury to you or others.

The quick release function is at the front of the harness. The harness straps must always stay at the correct position.

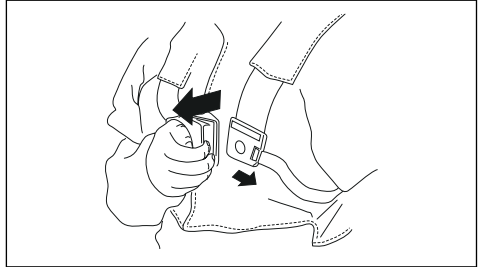

In an emergency, the quick release function helps you to remove the product safely.

Operation

Introduction



WARNING: Before you operate the product, you must read and understand the safety chapter.

Before you operate the product

- Examine the work area to make sure that you know the type of terrain, the slope of the ground and if there are obstacles such as stones, branches and ditches.

- Do an overhaul inspection of the product.
- Do the safety inspections, maintenance and servicing that are given in this manual.
- Make sure that all covers, guards, handles and the cutting equipment are correctly attached and not damaged.
- Make sure that there are no cracks at the bottom of the saw blade or grass blade teeth or by the center hole of the blade. Replace the blade if it is damaged.

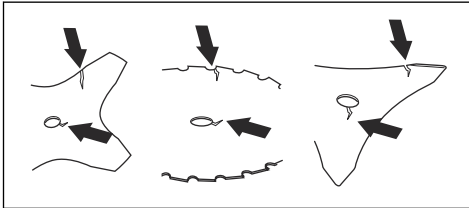

- Examine the support flange for cracks. Replace the support flange if it is damaged.

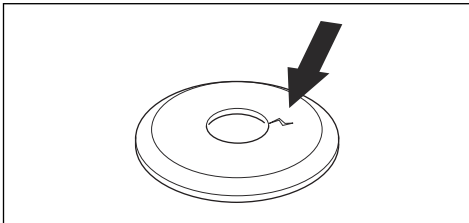

- Make sure that the locknut can not be removed by hand. If you can remove it by hand, it does not lock the cutting attachment sufficiently and you must replace it.

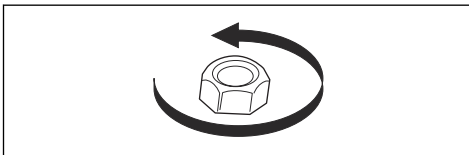

- Examine the blade guard for damages or cracks. Replace the blade guard if it has been hit or if it has cracks.
- Examine the trimmer head and cutting attachment guard for damages or cracks. Replace the trimmer head and cutting attachment guard if they have been hit or if they have cracks.

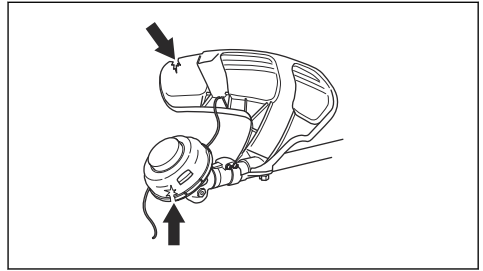

Fuel

This product has a two-stroke engine.



CAUTION: Incorrect type of fuel can result in engine damage. Use a mixture of gasoline and two-stroke oil.

Gasoline



CAUTION: Always use a quality gasoline/oil mixture of at least 90 octane (RON). There is a risk that use of lower octane grade causes knocking. This gives rise to high engine temperature, which can result in serious engine damage.



CAUTION: If your product is equipped with a catalytic converter use a good quality unleaded gasoline/oil mixture. Leaded gasoline will destroy the catalytic converter.

- Use low-emission gasoline, also known as alkylate gasoline, if it is available.

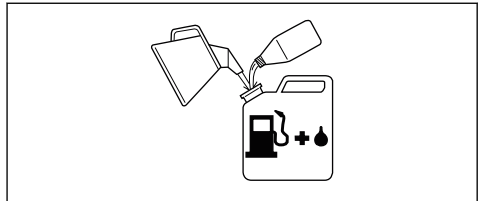

- Ethanol blended fuel, E10 may be used (max 10% ethanol blend). Using ethanol blends higher than E10 will cause lean running condition which can damage the engine.
- We recommend a higher octane rating when you do work at continuous high speed.

Husqvarna alkylate fuel

We recommend you to use Husqvarna alkylate fuel for best performance. The fuel contains less dangerous material compared to regular fuel, which decreases dangerous exhaust fumes. The fuel gives a low quantity of dangerous remainings when it is combusted, which

keeps the components of the engine more clean. This extends the life of the engine. Husqvarna alkylate fuel is not available in all markets.

Two-stroke oil

- For best results and performance use Husqvarna two-stroke oil, which is specially formulated for our two-stroke engines.
- If Husqvarna two-stroke oil is not available, use a different two-stroke oil of good quality that is formulated for air-cooled engines. Consult your servicing dealer when you select an oil.
- Do not use two-stroke oil for water-cooled outboard engines, also referred to as outboard oil.
- Do not use oil intended for four-stroke engines.

Gasoline, l	Two-stroke oil, l
	2% (50:1)
5	0.10
10	0.20
15	0.30
20	0.40
US gallon	US fl. oz.
1	2 ½
2 ½	6 ½
5	12 ½

To mix gasoline and two-stroke oil



CAUTION: There is a risk that small errors influence the ratio of the mixture drastically when you mix small quantities of fuel. Carefully measure the quantity of oil to be mixed to make sure that you get the correct mixture.

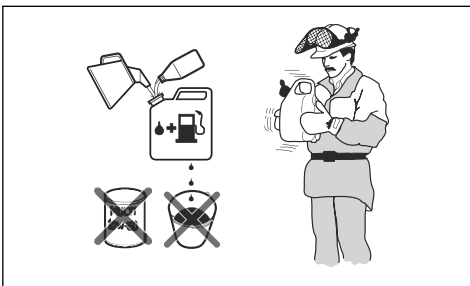

1. Fill half the quantity of the gasoline to be used.
2. Add the full quantity of oil and mix (shake) the fuel mixture.

3. Add the remaining quantity of gasoline.
4. Carefully mix (shake) the fuel mixture and fill the fuel tank of the product.
5. Empty and clean the fuel tank if you do not use the product for some time.

Note: Do not mix fuel for more than 1 month at a time and always mix gasoline and oil in a clean container intended for fuel.

To fill the fuel tank

1. Clean the area around the fuel tank cap.
2. Shake the container and make sure that the fuel is fully mixed. Use a fuel container with an anti-spill valve.
3. Fill the fuel tank.
4. Tighten the fuel tank cap carefully.
5. Move the product 3 m (10 ft) or more away from the refueling area and fuel source before starting.

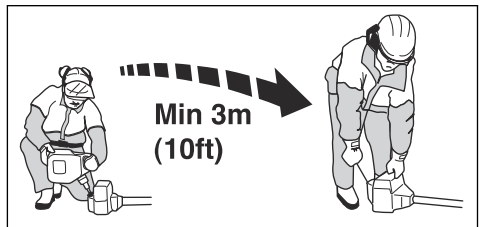

CAUTION: Contamination in the tanks causes malfunction. Clean the fuel tank and chain oil tank regularly and replace the fuel filter one time a year or more.

Work position

- Hold the product with 2 hands.
- Hold the product on the right side of your body.
- Keep the cutting attachment below waist level.
- Always keep the product attached to the harness.
- Keep body parts away from the hot surfaces.
- Keep body parts away from the cutting attachment.

Correct balance of the product

For forestry clearing, the product is correctly balanced when it freely hangs horizontally from the suspension

point. With correct balance, the risk of hitting stones if you release the handlebar is decreased.

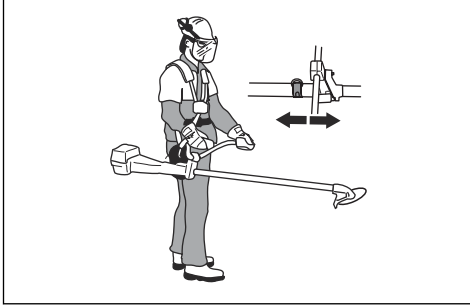

For grass clearing, the product is correctly balanced when the blade is at cutting height near the ground.

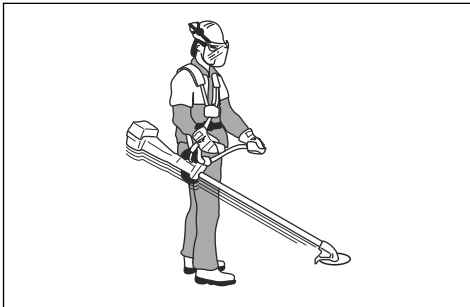

To prepare the product for start

1. Press the air purge again and again until the fuel starts to fill the bulb.

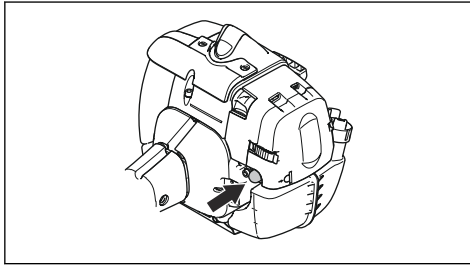

Note: It is not necessary to fully fill the bulb.

2. Move the choke control up into choke position.

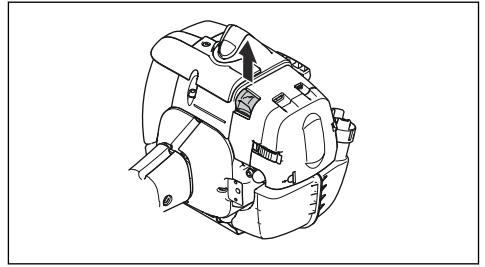

WARNING: The cutting attachment will start to rotate immediately when you start the engine with the choke.

To start the product



WARNING: Read the warning instructions in the safety chapter before you start the product (refer to *Safety on page 4*).

1. Use protective gloves.
2. Hold the body of the product on the ground with your left hand.



CAUTION: Do not use your feet!

3. Hold the starter rope handle with your right hand.
4. Slowly pull out the starter rope with your right hand until you feel some resistance (the starter pawls grip).



WARNING: Do not twist the starter rope around your hand.

5. Pull the cord quickly and with power.



CAUTION: Do not pull the starter rope all the way out and do not let go off the starter rope handle when the starter rope is fully extended. This can cause damage to the product.

6. Pull the starter rope until the engine starts or for a maximum of 5 times.
7. Reset the choke when the engine starts or after you pull the starter rope 5 times.
8. If it is necessary, pull the starter rope again and again until the engine starts.
9. Let the engine run for 10 seconds.
10. Operate the throttle gradually.
11. Make sure the engine runs smoothly.

Note: If the engine stops, do the procedure again.

To start with a throttle handle with a start throttle lock

1. Push the throttle lockout and the throttle trigger to set the throttle to the start position. Then push the start throttle button (A).
2. Release the throttle lockout and the throttle trigger, followed by the start throttle button. The throttle function is now activated.
3. To return the engine to idle speed, push the throttle lockout and throttle trigger again.

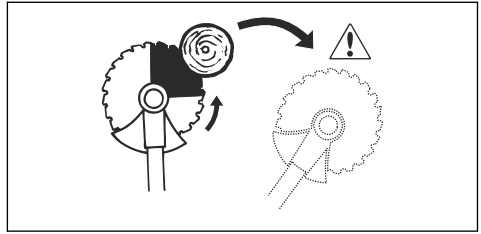
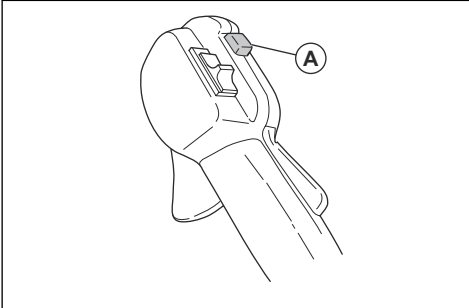

General work instructions



WARNING: Be careful when you cut a tree that is in tension. It can spring back to its normal position before or after the cut and hit you or the product, and cause injury.

- Clear an open space at one end of the work area, and start the work from there.
- Move in a regular pattern across the work area.

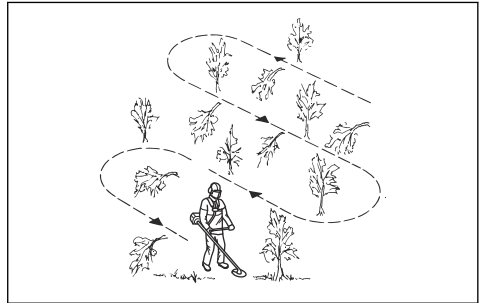

- Move the product fully to the left and right, to clear a width of 4–5 m on each turn.
- Clear a length of 75 m before you turn and go back. Move the fuel can along with you as you continue.
- Move in a direction where you do not go across ditches and obstacles more than necessary.
- Move in a direction where the wind makes the cut vegetation fall in the cleared area.

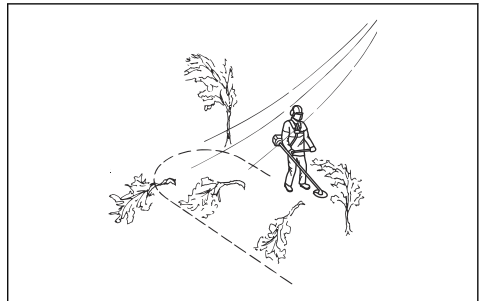

- Move along slopes, not up and down.

To stop the product

- Move the stop switch to the stop position to stop the engine.



CAUTION: The stop switch automatically goes back to run position.

Blade thrust

A blade thrust is when the product moves to the side quickly and with force. A blade thrust occurs when the grass blade or saw blade hits or catches on an object that cannot be cut. A blade thrust can eject the product or operator in all directions. There is a risk of injury to the operator and bystanders.

The risk increases in areas where it is not easy to see the material that is cut.

Do not cut with the area of the blade that is shown in black. The speed and movement of the blade can cause blade thrust. The risk increases with the thickness of the branch that is cut.

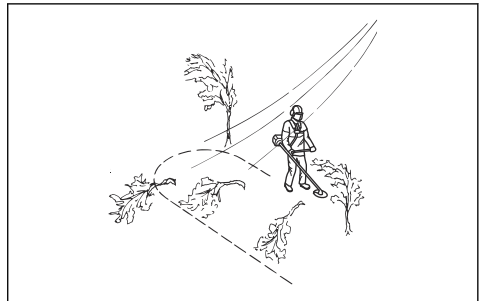

- Move along slopes, not up and down.

Forestry clearing with a saw blade

To fell a tree to the left

To fell to the left, push the bottom of the tree to the right.

1. Apply full throttle.
2. Put the saw blade against the tree as given in the picture.
3. Tilt the saw blade and push it with force diagonally down to the right. At the same time, push the tree with the blade guard.

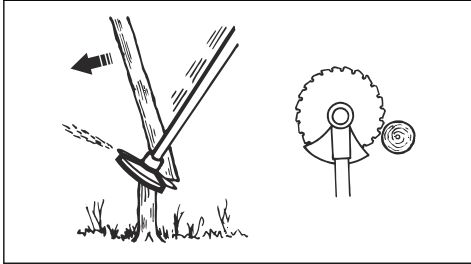

To fell a tree to the right

To fell to the right, push the bottom of the tree to the left.

1. Apply full throttle.
2. Put the saw blade against the tree as given in the picture.
3. Tilt the saw blade and push it with force diagonally up and to the right. At the same time, push the tree with the blade guard.

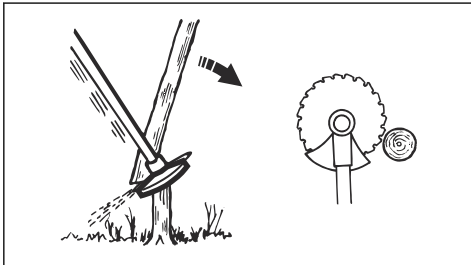

To fell a tree forward

To fell forward, push the bottom of the tree rearward.

1. Apply full throttle.
2. Put the saw blade against the tree as given in the picture.

3. Pull the saw blade forward with a fast movement.

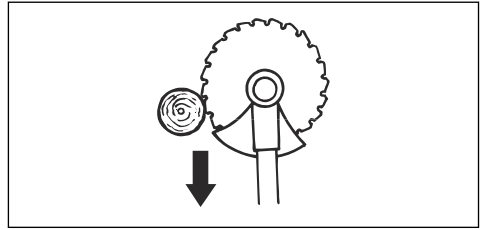

To fell large trees

Large trees must be cut from 2 sides.

1. Examine in which direction the tree will fall.
2. Apply full throttle.
3. Do the first cut on the side of the tree to which it will fall.

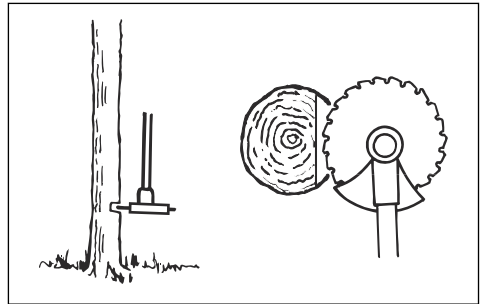

4. Cut through the tree from the other side.

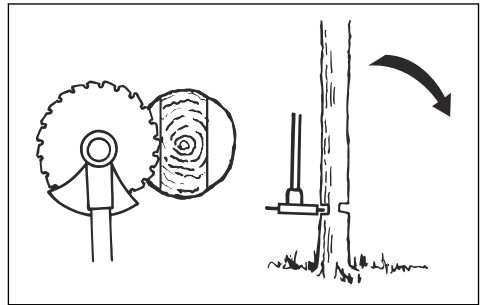

CAUTION: If the saw blade becomes blocked, do not pull the product with a sudden movement. That can cause damage to the saw blade, bevel gear, shaft or handlebar. Release the handles, hold the shaft with 2 hands and carefully pull the product.

Note: Use more cutting pressure to fell small trees. Use less cutting pressure to fell large trees.

Brush cutting with a saw blade

To fell to the left, push the bottom of the tree to the right.

- Cut down thin trees and brush.
- Move the product from side to side.
- Cut many trees in one movement.
- For groups of thin trees:

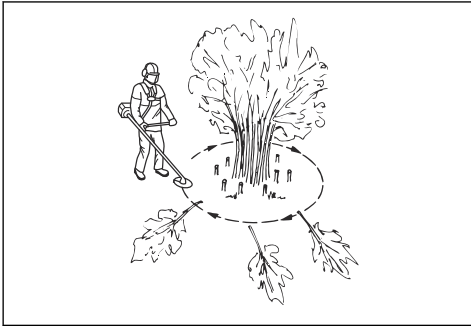

- a) Cut the outer trees high up.
- b) Cut the outer trees to the correct height.
- c) Cut from the center. If you cannot get access to the center, cut the outer trees high up and let them fall. This decreases the risk that the saw blade becomes blocked.

Grass clearing with a grass blade



CAUTION: Do not use grass blades and grass knives on wood. Use grass blades and grass knives for long or heavy grass only.

- Move the product from side to side.
- Start the movement from right to left when you cut. Move the product to the right before you cut again.
- Cut with the left side of the grass blade.

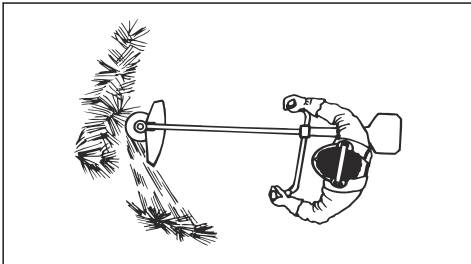

- Angle the grass blade to the left to make the grass fall in a line. This makes it easy to collect the grass.
- Keep a stable position with your feet apart.
- Move forward after each right movement and make sure that you have a stable position again before you cut again.

- Keep the support cup with a light pressure against the ground to make sure that the grass blade does not hit the ground.
- Obey these instructions to decrease the risk that cut material winds around the grass blade:
 - a) Apply full throttle.
 - b) Do not move the grass blade through cut material when you move the product from left to right.
- Before you collect the cut material, stop the engine and remove the product from the harness. Put the product down on the ground.

Grass trimming with a trimmer head

To trim the grass

1. Hold the trimmer head immediately above the ground at an angle. Do not push the trimmer line into the grass.

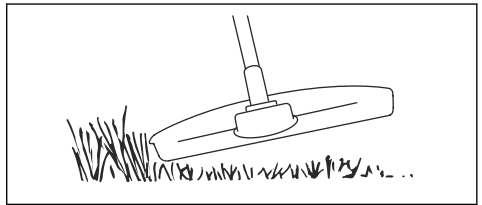

2. Decrease the length of the trimmer line by 10-12 cm / 4-4.75 in.
3. Decrease the engine speed to decrease the risk of damage to plants.
4. Use 80 % throttle when you cut grass near objects.



To clear grass with a grass blade

1. Keep your feet apart during operation of the product. Make sure feet are tightly against the ground.
2. Put the support cup lightly on the ground. This prevents the blade from touching the ground.

- Use a sideways movement from right to left for a clear stroke. Use the left side of the blade (between 8 and 12 o'clock) to cut.

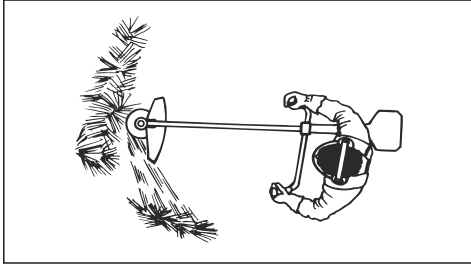

- Angle the blade to the left when you clear grass.

Note: The grass collects easily in a line.

- Use a sideways movement from left to right for the return stroke.
- Do the work rhythmically.
- Move forward and keep feet tightly against the ground.
- Stop the engine.
- Remove the product from the clip on the harness.
- Put the product on the ground.
- Collect the cut material.

To cut the grass

- Make sure that the trimmer line is parallel to the ground when you cut the grass.

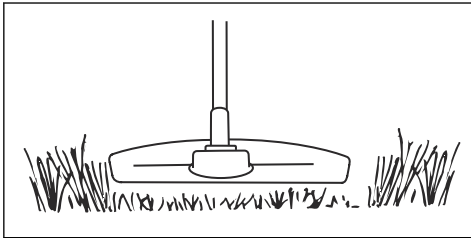

- Do not push the trimmer head to the ground. This can cause damage to the product.
- Move the product from side to side when you cut grass. Use full speed.

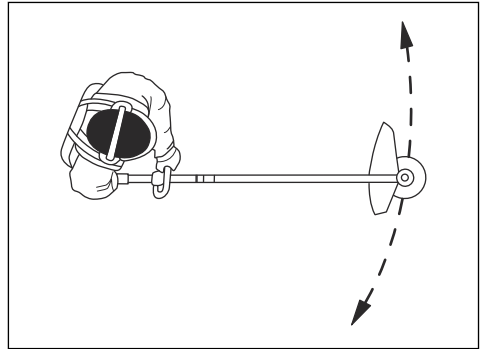

To sweep the grass

The airflow from the rotating trimmer line can be used to remove cut grass from an area.

- Hold the trimmer head and the trimmer line parallel to the ground and above the ground.
- Apply full throttle.
- Move the trimmer head from side to side and sweep the grass.



WARNING: Clean the trimmer head cover each time you assemble new trimmer line to prevent unbalance and vibrations in the handles. Also do a check of the other parts of the trimmer head and clean it if necessary.

Maintenance

Introduction



WARNING: Before you do maintenance, you must read and understand the safety chapter.

For all servicing and repair work on the product, special training is necessary. We guarantee the availability of professional repairs and servicing. If your dealer is not a service agent, speak to them for information about the nearest service agent.

For more detailed information, refer to .

Maintenance schedule

Maintenance	Daily	Weekly	Monthly
Clean the external surface.	X		

Maintenance	Daily	Weekly	Monthly
Examine the harness for damages.	X		
Examine the suspension ring for damages.	X		
Do a check of the handle and the handlebar to make sure that they are attached correctly and not damaged.	X		
Make sure that the throttle trigger lock and the throttle works correctly.	X		
Do a check of the stop switch to make sure that it operates correctly.	X		
Make sure that the cutting attachment does not rotate at idle speed.	X		
Clean the air filter. Replace if it is necessary.	X		
Make sure that the blade is sharp and put correctly in the center, look for cracks. If the blade is not put correctly, it can cause damage to the product.	X		
Examine the cutting attachment guard for damages and cracks. If it is damaged, replace it.	X		
Examine the trimmer head for damages and cracks. If it is damaged, replace it.	X		
Make sure that the screws and nuts are tight.	X		
Examine the engine, the fuel tank and the fuel lines for leaks.	X		
Examine the transport guard. Make sure that the blade is not damaged and that the transport guard can be attached correctly.	X		
Clean the cooling system.		X	
Examine the starter and the starter rope for damages.		X	
Examine the vibration damping units for damages and cracks.		X	
Clean the external surface part of the spark plug. Remove it and do a check of the electrode gap. Adjust the electrode gap to the correct distance (Refer to <i>Technical data on page 28</i>) or replace the spark plug. Make sure that the spark plug is has a supressor.		X	
Clean the external surface of the carburetor and the area around it.		X	
Do a check of the bevel gear to make sure that it is filled $\frac{3}{4}$ with lubricant. Use special grease to fill if it is necessary.		X	
Clean or replace the spark arrestor mesh on the muffler.		X	
Do a check of the safety release on the harness and make sure that it is not damaged and works.			X
Do a check of the fuel filter for contamination and the fuel hose for cracks or other damages. Replace if it is necessary.			X
Do a check of all cables and connections.			X
Do a check of the clutch, clutch springs and the clutch drum for wear. If it is necessary to replace 1 or more of these units, speak to your servicing dealer.			X
Replace the spark plug. Make sure that the spark plug has a supressor.			X

To clean the cooling system



CAUTION: A dirty or blocked cooling system can make the product too hot, which can cause damage to the product.

The parts of the cooling system are the air intake on the starter (A), the cooling fins on the cylinder (B) and the cylinder cover (C).

1. Clean the cooling system with a brush weekly or more frequently if it is necessary.

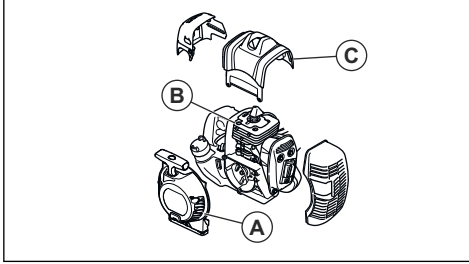

2. Make sure that the cooling system is not dirty or blocked.

To do a check of the muffler



WARNING: Do not use a product that has a damaged muffler or a muffler that is in bad condition.



WARNING: Do not use the product if the spark arrester screen on the muffler is missing or damaged.



WARNING: A used muffler/spark arrester and spark arrester mounting face may contain deposits of combustion particles on the surfaces that may be carcinogenic. To avoid skin contact and inhalation of such particles when cleaning and/or servicing the spark arrester, make sure you always:

- wear gloves;
- clean and/or service in a well ventilated area;
- do not use pressurized air to clean the spark arrester screen;
- use a steel brush and brush away from your body when cleaning the spark arrester.

1. Examine the muffler for damages.

2. Make sure that the muffler is correctly attached to the product.

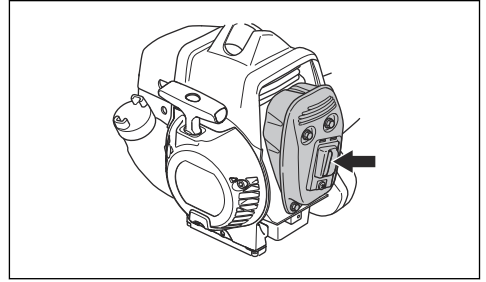

3. If your product has a special spark arrester screen, clean the spark arrester screen weekly.
4. Replace a damaged spark arrester screen.

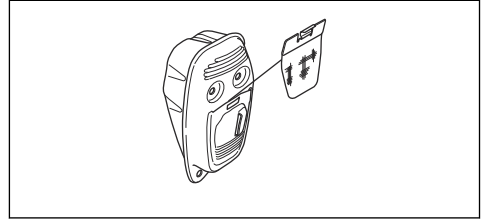

Note: Do not remove the muffler from the product.



CAUTION: If the spark arrester screen is blocked, the product becomes too hot and this causes damage to the cylinder and piston.

Air filter

Remove dust and dirt from the air filter to keep it clean and prevent these problems:

- Carburetor malfunctions.
- Problems when you start the product.
- Loss of engine power.
- Increased wear to engine parts.
- Too much fuel consumption.

To clean the air filter

Clean the air filter regularly from dirt and dust. This prevents carburetor malfunctions, starting problems,

loss of engine power, wear to engine parts and more fuel consumption than usual.

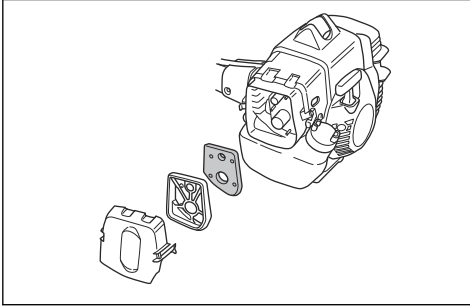

- Clean the air filter at an interval of 25 hours, or more regularly if you operate the product in conditions with much dust.

To apply oil to the foam air filter



CAUTION: Always use Husqvarna special air filter oil. Do not use other types of oil.



WARNING: Put on protective gloves. The air filter oil can cause skin irritation.

1. Put the foam air filter in a plastic bag.
2. Put the oil in the plastic bag.
3. Rub the plastic bag to supply the oil equally across the foam air filter.
4. Push the unwanted oil out of the foam air filter while in the plastic bag.

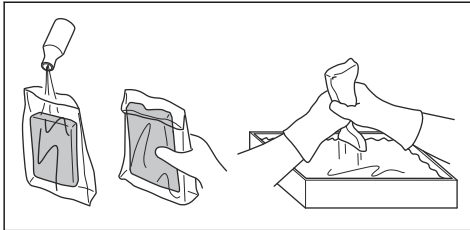

To lubricate the bevel gear

1. Remove the cutting equipment.
2. Put the product with the grease plug at its highest position.

3. Remove the grease plug.

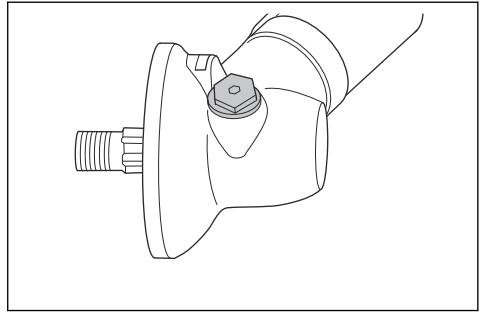

4. Look into the grease plug hole and turn the drive shaft. The grease level (A) must be in level with the top of the gear cogs (B).

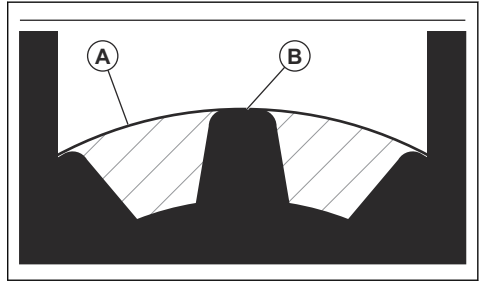

5. If the grease level is too low fill the bevel gear with Husqvarna bevel gear grease. Fill slowly and turn the drive shaft as you apply the bevel gear grease, stop at the correct level (B).



CAUTION: An incorrect quantity of grease can cause damage to the bevel gear.

6. Install the grease plug.

To attach and remove the locknut



WARNING: Stop the engine, use protective gloves and be careful around the sharp edges of the cutting attachment.

A locknut is used to attach some types of cutting attachments. The locknut has a left thread.

- To attach, tighten the locknut in the opposite direction to the direction of turning of the cutting attachment.
- To remove the locknut, loosen the locknut in the same direction as the cutting attachment rotates.

- To loosen and tighten the locknut, use a socket wrench with a long shaft. The arrow in the picture shows the area where you can operate the socket wrench.

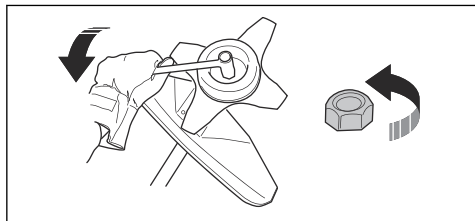

WARNING: When you loosen and tighten the locknut, there is a risk of injury from the blade. You must always make sure that the blade guard prevents injury to your hand when you do this.

Note: Make sure that you can not turn the locknut by hand. Replace the nut if the nylon lining does not have a resistance of a minimum of 1.5 Nm. The locknut must be replaced after it has been put on approximately 10 times.

To examine the spark plug



CAUTION: Always use the recommended spark plug type. Incorrect spark plug type can cause damage to the product.

- Examine the spark plug if the engine is low on power, is not easy to start or does not operate correctly at idle speed.
- To decrease the risk of unwanted material on the spark plug electrodes, obey these instructions:
 - a) Make sure that the idle speed is correctly adjusted.
 - b) Make sure that the fuel mixture is correct.
 - c) Make sure that the air filter is clean.
- If the spark plug is dirty, clean it and make sure that the electrode gap is correct, refer to *Technical data on page 28*.

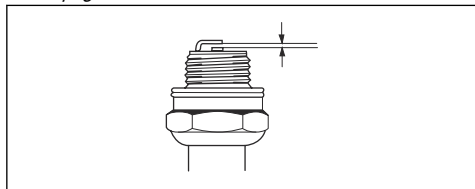

- Replace the spark plug if it is necessary.

To adjust the engine

Follow these instructions if the engine does not operate correctly.

1. Attach an approved cutting attachment, see *Accessories on page 29*.
2. Start the engine.
3. Operate the product in usual conditions for 3 minutes.
4. Lift the cutting attachment in the air and apply full throttle for 30 seconds. If a trimmer head is used, make sure that the trimmer line is cut to correct length by the guard knife.

Note: Do not cut grass or branches during this step.

5. Operate the product in usual conditions to make sure that the engine operates correctly.
6. If the engine does not operate correctly, do step 4 and 5 again 3 times.
7. Let your Husqvarna dealer adjust/repair the product if the engine does not operate correctly after you have done all these steps.

To adjust the low speed needle (L)

- Turn the low speed needle clockwise until stop.

Note: If the product has a bad acceleration capacity or if the idle speed is not correct, turn the low speed needle counterclockwise. Turn the low speed needle until the acceleration capacity and idle speed is correct.

To adjust the high speed needle (H)

The engine is adjusted at the factory to operate at sea level. At higher altitudes, in different weather or different temperatures it can be necessary to adjust the high speed needle.

- Turn the high speed needle to make adjustments.



CAUTION: Do not turn the high speed needle screw across the adjustment limitation stop. This can cause damage to the piston and the cylinder.

To adjust the start throttle speed

1. Apply idle speed.
2. Push the start throttle lock. Refer to *To start with a throttle handle with a start throttle lock on page 18*.

- If the start throttle speed is less than 4000 rpm, turn the adjuster screw (A) clockwise until the cutting attachment rotates. Turn the adjuster screw (A) clockwise 1/2 turn more.

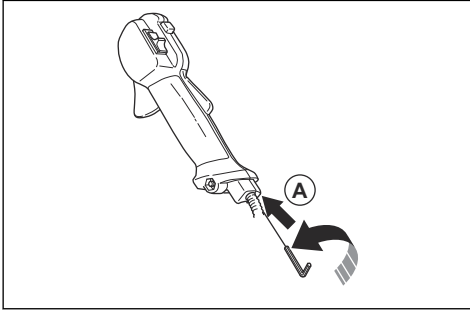

- If the start throttle speed is too high, turn the adjuster screw (A) counterclockwise until the cutting attachment stops. Turn the adjuster screw (A) clockwise 1/2 turn more.

To adjust the idle speed

Your Husqvarna product is designed and made to specifications that decrease harmful emissions.

- Make sure that the air filter is clean and the air filter cover is attached before you adjust the idle speed.
- Adjust the idle speed with the idle adjustment screw T which is identified with "T" mark.



WARNING: If the cutting attachment does not stop when you adjust the idle speed, turn to your nearest servicing dealer. Do not use the product until it is correctly adjusted or repaired.

- The idle speed is correct when the engine operates smoothly in all positions. The idle speed must be below the speed when the cutting attachment starts to turn.
- Turn the idle adjustment screw clockwise until the cutting attachment starts to turn.

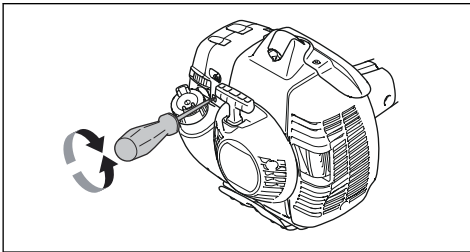

- Turn the idle adjustment screw counterclockwise until the cutting attachment stops.

Note: See *Technical data on page 28* for the recommended idle speed.

To sharpen the grass knife and grass blade



WARNING: Stop the engine. Use protective gloves.

- To sharpen the grass knife or grass blade correctly, refer to the instructions that come with the cutting attachment.
- Sharpen all edges equally to keep the balance.
- Use a single-cut flat file.

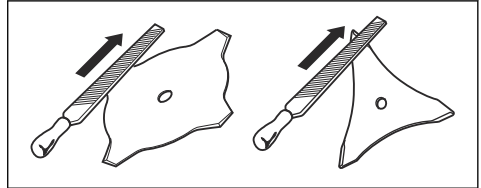

WARNING: Always discard a blade that is damaged. Do not try to make a bent or twisted blade straight and use it again.

To sharpen the saw blade



WARNING: Stop the engine. Use protective gloves.

- To sharpen the blade correctly, refer to the instructions that come with the blade.
- Make sure that the product and blade has sufficient support when you sharpen it.

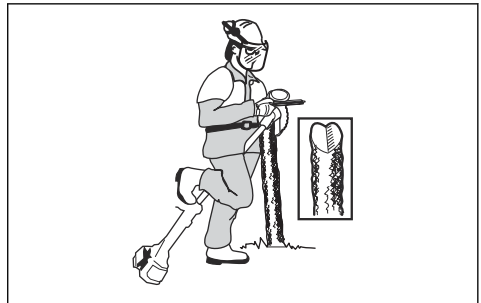

- Use a 5.5 mm round file with a file holder.

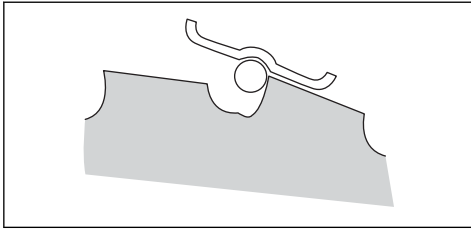

- Hold the file at an angle of 15°.
- Sharpen one tooth of the saw blade to the right and the next tooth to the left, see the illustration.

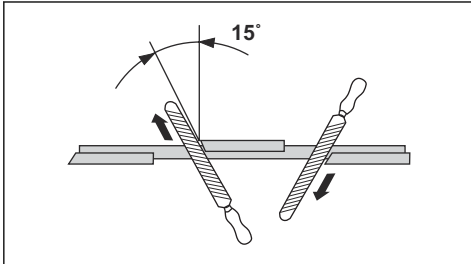

Note: Sharpen the edges of the teeth with a flat file if the blade is heavily worn. Continue to sharpen with a round file.

- Sharpen all edges equally to keep the blade balanced.
- Adjust the blade set to 1 mm with the recommended setting tool. Refer to the instructions that come with the blade.

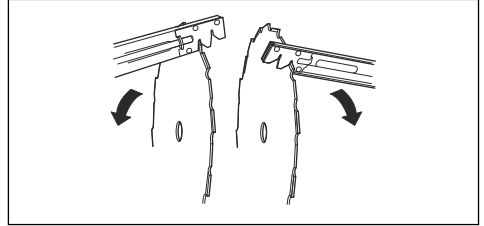

WARNING: Always discard a blade that is damaged. Do not try to make a bent or twisted blade straight and use it again.

Troubleshooting

The engine does not start

Check	Possible cause	Procedure
Stop switch.	The stop switch is in the stop position.	Let an approved service agent replace the stop switch.
Starter pawls.	The starter pawls cannot move freely.	Remove the starter cover and clean around the starter pawls. See <i>Product overview on page 2</i> .
		Let an approved service agent help you.
Fuel tank.	Incorrect fuel type.	Drain the fuel tank and fill with correct fuel.
Spark plug.	The spark plug is dirty or wet.	Make sure that the spark plug is dry and clean.
	The spark plug electrode gap is incorrect.	Clean the spark plug. Make sure that the electrode gap is correct. Make sure that the spark plug has a suppressor.
		Refer to technical data for correct electrode gap.
	The spark plug is loose.	Tighten the spark plug.

The engine starts but stops again

Check	Possible cause	Procedure
Fuel tank	Incorrect fuel type.	Empty the fuel tank and fill it with correct fuel.
Air filter	The air filter is clogged.	Clean the air filter.

Transportation, storage and disposal

Transportation and storage

- Store and transport the product and fuel so that there is no risk that any leakage or fumes comes in contact with sparks or open flames, for example, from electrical machinery, electric motors, electrical relays/switches or boilers.
- When you store and transport fuel always use approved containers intended for this purpose.
- When you store the product for long periods the fuel tank must be emptied. Contact your local petrol station to find out where to dispose excess fuel. Drain the tank into the appropriate containers and in a well ventilated area.
- Ensure that the product is cleaned and that a complete service is carried out before long-term storage.
- The transport guard must always be fitted to the cutting attachment when the product is transported or in storage.

- Secure the product during transport.
- In order to prevent unintentional start of the engine, the spark plug cap must always be removed during long-term storage if the product is not under close supervision and when you perform all service measures.
- Allow the product to cool before you put in storage.

Disposal

- Obey the local recycling requirements and applicable regulations.
- Discard all chemicals, such as engine oil or fuel, at a service center or at an applicable disposal location.
- When the product is no longer in use, send it to a Husqvarna dealer or discard it at a recycling location.

Technical data

Technical data

	535RX	535RXT
Engine		
Cylinder displacement, cu.in/cm ³	2.11/34.6	2.11/34.6
Cylinder bore, in/mm	1.50/38.0	1.50/38.0
Stroke, in/mm	1.20/30.5	1.20/30.5
Idle speed, rpm	2900	2900
Recommended max. speed, rpm	11500	11500
Speed of output shaft, rpm	8220	8220
Max. engine output, according to ISO 8893, kW/rpm	1.60/8400	1.6/8400
Catalytic converter muffler	Yes	Yes
Speed-regulated ignition system	Yes	Yes

	535RX	535RXT
Ignition system		
Spark plug	Champion RCJ 6Y	Champion RCJ 6Y
Electrode gap, in/mm	0.02/0.5	0.02/0.5
Fuel and lubrication system		
Fuel tank capacity, US pint/l	1.27/0.6	1.27/0.6
Weight		
Without fuel, cutting attachment and guard, lbs/kg	13.4/6.1	14.8/6.7
Sound levels ¹		
Equivalent sound pressure level at the operator's ear, measured according to EN ISO 11806 and ISO 22868, dB(A):		
Equipped with trimmer head (original)	95	95
Equipped with grass blade (original)	95	95
Vibration levels ²		
Equivalent vibration levels ($a_{hv,eq}$) at handles, measured according to EN ISO 11806 and ISO 22867, m/s ² :		
Equipped with trimmer head (original), left/right	3.0/3.4	2.4/3.1
Equipped with grass blade (original), left/right	3.4/4.1	2.5/2.7

Accessories

Accessories 535RX

Approved accessories	Accessory type	Cutting attachment guard, art. no.
Center hole in blades/knives, Ø 25.4 mm		
Output shaft thread M12		
Grass blade/grass cutter	Multi 255-3 (Ø 255 3 teeth)	537 33 16
	Grass 255-4 (Ø 255 4 teeth)	537 33 16
	Multi 275-4 (Ø 275 4 teeth)	537 33 16
	Multi 300-3 (Ø 300 3 teeth)	537 33 16
Saw blade	Scarlet 200-22 (Ø 200 22 teeth)	537 38 77-01
Plastic blades	Tricut Ø 300 mm (Separate blades have part number 531 07 77-15)	537 33 16-01/ 537 34 94-01

¹ Reported data for noise pressure level has a typical statistical dispersion (standard deviation) of 1.2 dB (A).

² Reported data for vibration level has a typical statistical dispersion (standard deviation) of 0.2 m/s².

Approved accessories	Accessory type	Cutting attachment guard, art. no.
Trimmer head	T35, T35 (Ø 2.4 - 3.0 mm cord)	537 33 16-01 / 537 34 94-01
	S35 (Ø 2.4 - 3.0 mm cord)	537 33 16-01 / 537 34 94-01
	T45x (Ø 2.7 - 3.3 mm cord)	537 33 16-01 / 537 34 94-01
	Trimmy S II (Ø 2.4 - 3.3 mm cord)	537 33 16-01 / 537 34 94-01
Support cup	503 89 01-02	-

Warranty

FEDERAL EMISSION CONTROL WARRANTY STATEMENT

YOUR WARRANTY RIGHTS AND OBLIGATIONS

The EPA (The US Environmental Protection Agency), Environment Canada and Husqvarna are pleased to explain the emissions control system warranty on your 2009 and later small nonroad engine. In U.S. and Canada, new small nonroad engines must be designed, built and equipped to meet the federal stringent anti-smog standards. Husqvarna must warrant the emission control system on your small nonroad engine for the period of time listed below provided there has been no abuse, neglect or improper maintenance of your unit. Your emission control system includes Parts such as the carburetor and the ignition system. Where a warrantable condition exists, Husqvarna will repair your small nonroad engine at no cost to you. Expenses covered under warranty include diagnosis, parts and labor.

MANUFACTURER'S WARRANTY COVERAGE

The 2009 and later small nonroad engines are warranted for two years. If any emission related part on your engine (as listed above) is defective, the part will be repaired or replaced by Husqvarna.

OWNER'S WARRANTY RESPONSIBILITIES

As the small nonroad engine owner, you are responsible for the performance of the required maintenance listed in your operator's manual. Husqvarna recommends that you retain all receipts covering maintenance on your small nonroad engine, but Husqvarna cannot deny warranty solely for the lack of receipts or for your failure to ensure the performance of all scheduled maintenance. As the small nonroad engine owner, you should, however, be aware that Husqvarna may deny you warranty coverage if your small nonroad engine or a part of it has failed due to abuse, neglect, improper maintenance, unapproved modifications or the use of parts not made or approved by the original equipment manufacturer. You are responsible for presenting your small nonroad engine to a Husqvarna authorized servicing dealer as soon as a problem exists. The warranty repairs should be completed in a reasonable amount of time, not to exceed 30 days. If you have any questions regarding your warranty rights and responsibilities, you should contact your nearest authorized servicing dealer or call Husqvarna at 1-800-487-5951 or visit www.husqvarna.com.

WARRANTY COMMENCEMENT DATE

The warranty period begins on the date small nonroad engine is delivered.

LENGTH OF COVERAGE

Husqvarna warrants to the initial owner and each subsequent purchaser that the engine is free from

defects in materials and workmanship which cause the failure of a warranted part for a period of two years.

WHAT IS COVERED

REPAIR OR REPLACEMENT OF PARTS: Repair or replacement of any warranted part will be performed at no charge to the owner at an approved Husqvarna servicing dealer. If you have any questions regarding your warranty rights and responsibilities, you should contact your nearest authorized servicing dealer or call Husqvarna at 1-800-487-5951 or visit www.husqvarna.com.

WARRANTY PERIOD: Any warranted part which is not scheduled for replacement as required maintenance, or which is scheduled only for regular inspection to the effect of "repair or replace as necessary" shall be warranted for 2 years. Any warranted part which is scheduled for replacement as required maintenance shall be warranted for the period of time up to the first scheduled replacement point for that part.

DIAGNOSIS: The owner shall not be charged for diagnostic labor which leads to the determination that a warranted part is defective, if the diagnostic work is performed at an approved Husqvarna servicing dealer.

CONSEQUENTIAL DAMAGES: Husqvarna may be liable for damages to other engine components caused by the failure of a warranted part still under warranty.

WHAT IS NOT COVERED

All failures caused by abuse, neglect or improper maintenance are not covered.

ADD -ON OR MODIFIED PARTS: The use of add-on or modified parts can be grounds for disallowing a warranty claim. Husqvarna is not liable to cover failures of warranted parts caused by the use of add-on or modified parts.

HOW TO FILE A CLAIM

If you have any questions regarding your warranty rights and responsibilities, you should contact your nearest authorized servicing dealer or call Husqvarna at 1-800-487-5951 or visit www.husqvarna.com.

WHERE TO GET WARRANTY SERVICE

Warranty services or repairs shall be provided at all Husqvarna authorized servicing dealers.

MAINTENANCE, REPLACEMENT AND REPAIR OF EMISSION-RELATED PARTS

Any Husqvarna approved replacement part used in the performance of any warranty maintenance or repairs on emission-related parts, will be provided without charge to the owner if the part is under warranty.

EMISSION CONTROL WARRANTY PARTS LIST

1. Carburetor and internal parts.

2. Intake pipe, airfilter holder and carburetor bolts.
3. Airfilter and fuelfilter covered up to maintenance schedule.
4. Ignition system.
 - a. Spark Plug, covered up to maintenance schedule.
 - b. Ignition Module.
5. Muffler with catalytic converter.

MAINTENANCE STATEMENT

The owner is responsible for the performance of all required maintenance, as defined in the operator's manual.



www.husqvarna.com

Original instructions



1143279-95



2023-06-16