

36V EasiStore 340R
Art. 9705382-xx
Art. 9705383-xx

36V EasiStore 380R
Art. 9705384-xx
Art. 9705385-xx

Remark: "xx" stands for customer and country variants. The basic product number is before the hyphen.

EN Operator's manual
Battery Lawnmower

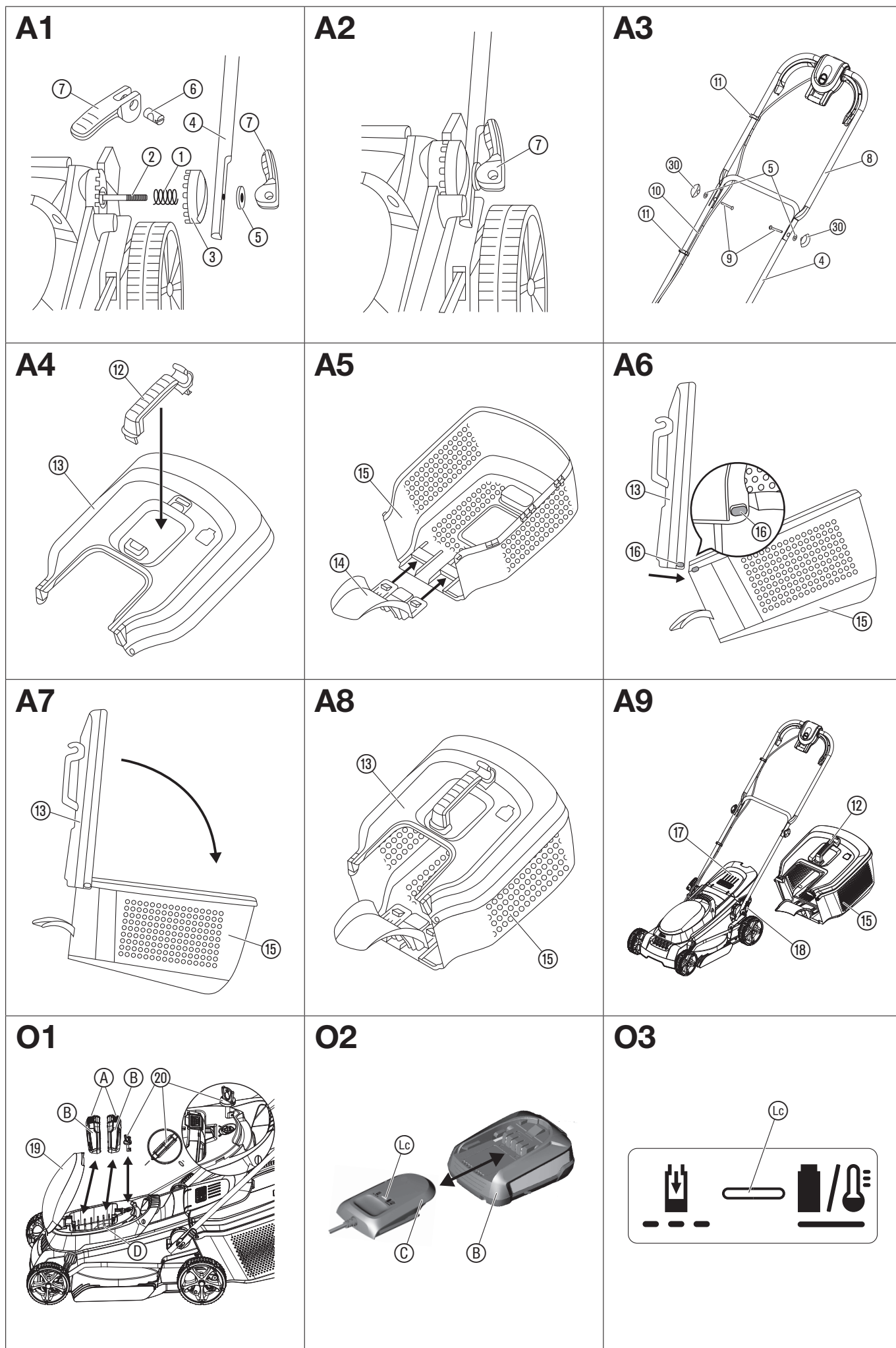

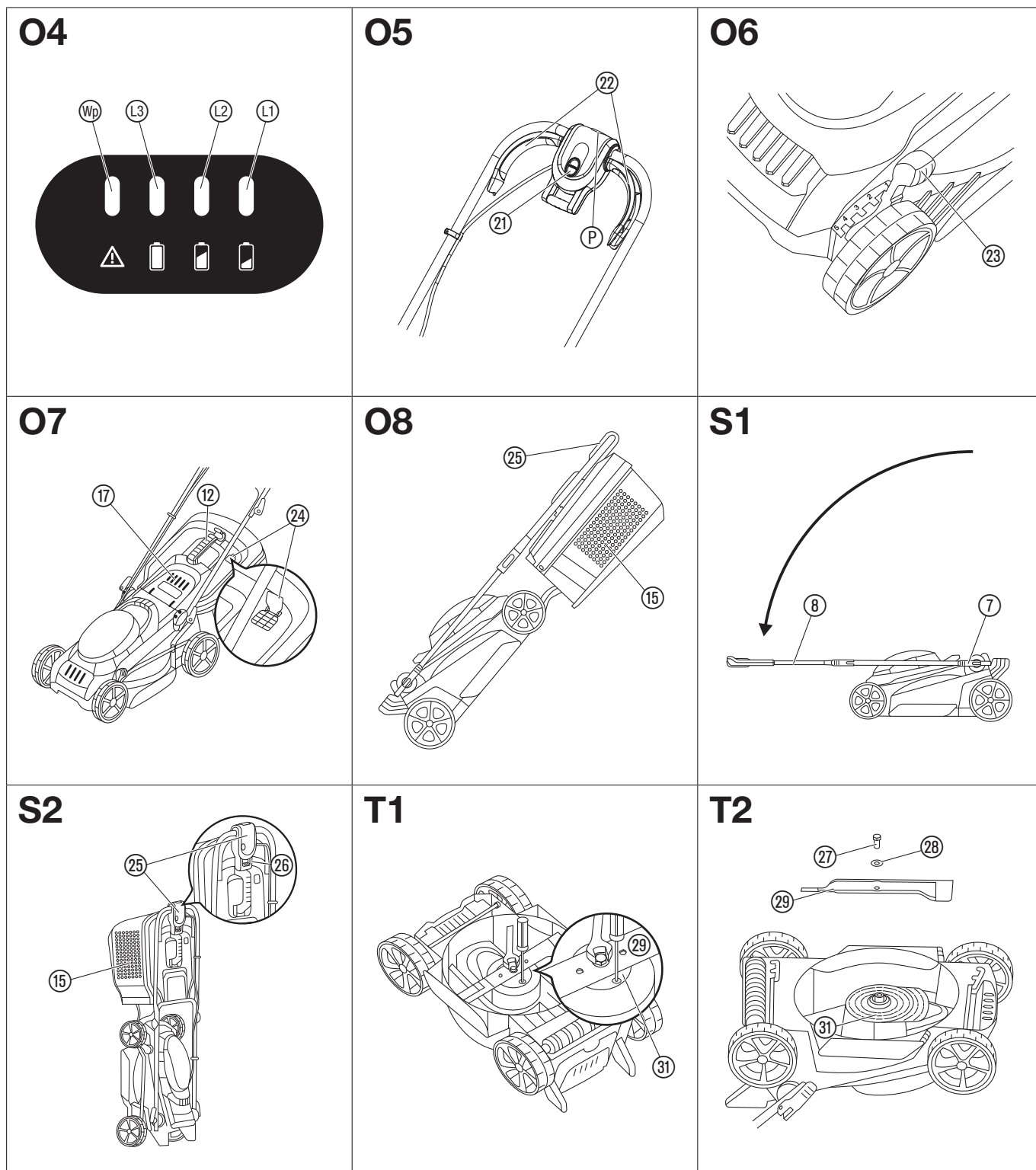

EN Battery Lawnmower

1. SAFETY	4
2. ASSEMBLY	5
3. OPERATION	6
4. MAINTENANCE	7
5. STORAGE	7
6. TROUBLESHOOTING	7
7. TECHNICAL DATA	8
8. ACCESSORIES	8
9. SERVICE/WARRANTY	8

Original instructions.

 This product may be used under supervision, or if instruction regarding the safe use of the product has been provided and the resulting dangers have been understood, by children aged 8 and above, as well as by persons with physical, sensory or mental disabilities or a lack of experience and knowledge. Children must not be allowed to play with the product. Cleaning and user maintenance must not be performed by children without supervision. The use of this product by young people under the age of 16 is not recommended.

Intended use:

The **FLYMO Lawnmower** is intended to mow lawns in private domestic gardens and allotments.

The product is not intended for long term use.



DANGER! Risk of injury!

→ Do not use the product to cut bushes, hedges, shrubs, to cut of climbers or grass on roofs or balcony boxes, to chop up branches, twigs and to level irregularities in the soil. Do not use the product on a slope steeper than 20° maximum.

1. SAFETY

IMPORTANT!

Read the operator's manual carefully before use and keep for future reference.

Symbols on the product:



Read operator's manual.



Keep bystanders away.



Not valid for the battery mower.



Beware of sharp blades. Blades continue to rotate after the motor is switched off.
Remove disabling device before maintenance.



Secure the working area before starting to work.
Watch out for hidden cables.

General safety warnings

Electrical safety for the charger



DANGER! Electric shock!

Risk of injury due to electric shock.

→ The product must be supplied through a residual current device (RCD) having a rated residual operating current not exceeding 30 mA.

Training

- Read the instructions carefully. Be familiar with the controls and the correct use of the machine.
- Never allow children or people unfamiliar with these instructions to use the machine. Local regulations can restrict the age of the operator.
- Never operate the machine while people, especially children, or pets are nearby.
- Keep in mind that the operator or user is responsible for accidents or hazards occurring to other people or their property.

Preparation

- While operating the machine always wear substantial footwear and long trousers. Do not operate the machine when barefoot or wearing open sandals. Avoid wearing clothing that is loose fitting or that has hanging cords or ties.
- Thoroughly inspect the area where the machine is to be used and remove all objects which can be thrown by the machine.
- Before using, always visually inspect to see that the blade, blade bolt and the blade assembly are not worn or damaged. Replace worn or damaged components in set to preserve balance. Replace damaged or unreadable labels.
- Before use check the supply and extension cord for signs of damage or aging. If the cord becomes damaged during use, disconnect the cord from the supply immediately. **DO NOT TOUCH THE CORD BEFORE DISCONNECTING THE SUPPLY.** Do not use the machine if the cord is damaged or worn.

Operation

- Operate the machine only in daylight or in good artificial light.
 - Avoid operating the machine in wet grass.
 - Always be sure of your footing on slopes.
 - Walk, never run.
 - Mow across the face of slopes, never up and down.
 - Exercise extreme caution when changing direction on slopes.
 - Do not mow excessively steep slopes.
 - Use extreme caution when reversing or pulling the machine towards you.
 - Stop the blade(s) if the machine has to be tilted for transportation when crossing surfaces other than grass, and when transporting the machine to and from area to be used.
 - Never operate the machine with defective guards or shields, or without safety devices, for example deflectors and/or grass collector, in place.
 - Switch on the motor carefully according to instructions and with feet well away from the blade(s).
 - Do not tilt the machine when switching on the motor, except if the machine has to be tilted for starting. In this case, do not tilt it more than absolutely necessary and lift only the part, which is away from the operator.
 - Do not start the machine when standing in front of the discharge opening.
 - Do not put hands or feet near or under rotating parts. Keep clear of the discharge opening at all times.
 - Do not transport the machine while the power source is running.
 - Stop the machine, and remove the disabling device. Make sure that all moving parts have come to a complete stop:
 - whenever you leave the machine,
 - before clearing blockages or unclogging chute,
 - before checking, cleaning or working on the machine,
 - after striking a foreign object. Inspect the machine for damage and make repairs before restarting and operating the machine;
- if the machine starts to vibrate abnormally (check immediately):
- inspect for damage,
 - replace or repair any damaged parts,
 - check for and tighten any loose parts.

Maintenance and storage

- Keep all nuts, bolts, and screws tight to be sure the machine is in safe working condition.
- Check the grass collector frequently for wear or deterioration.
- Replace worn or damaged parts for safety.
- On machines with multi blade, take care as rotating one blade can cause other blades rotate.
- Be careful during adjustment of the machine to prevent entrapment of the fingers between moving blades and fixed parts of the machine.
- Always allow the machine to cool down before storing.
- When servicing the blades be aware that, even though the power source is switched off, the blades can still be moved.
- Use only genuine replacement parts and accessories.

Additional safety warnings

Battery safety



Read all the safety and general instructions.

Failure to observe the safety and general instructions may result in electric shock, fire and/or serious injury.

Store these instructions in a safe place. Only use the charger if you can fully evaluate all functions and carry them out without restrictions, or if you have received corresponding instructions.

→ **Supervise children during use, cleaning and maintenance.**
This will ensure that children do not play with the charger.

→ **Charge only lithium-ion batteries of the POWER FOR ALL system type PBA 18V with a capacity of 1.5 Ah or more (5 battery cells or more). The battery voltage must match the battery charging voltage of the charger. Do not charge any non rechargeable batteries.** Otherwise there is a risk of fire and explosion.

→  **Do not expose the charger to rain or wet conditions.**
Water entering a power tool will increase the risk of electric shock.

→ **Keep the charger clean.** Dirt poses a risk of electric shock.

→ **Always check the charger, cable and plug before use. Stop using the charger if you discover any damage. Do not open the charger yourself, and have it repaired only by a qualified specialist using only original replacement parts.**
Damaged chargers, cables and plugs increase the risk of electric shock.

→ **Do not operate the charger on an easily ignited surface (e.g. paper, textiles, etc.) or in a flammable environment.**
There is a risk of fire due to the charger heating up during operation.

→ In order to avoid safety hazards, if the power supply cord needs to be replaced, this must be done by FLYMO or by a customer service centre that is authorised to repair FLYMO power tools.

→ **Do not operate the product while it is charging.**

Products sold in GB only: Your product is fitted with an BS 1363/A approved electric plug with internal fuse (ASTA approved to BS 1362). If the plug is not suitable for your socket outlets, it should be cut off and an appropriate plug fitted in its place by an authorised customer service agent. The replacement plug should have the same fuse rating as the original plug. The severed plug must be disposed of to avoid a possible shock hazard and should never be inserted into a mains socket elsewhere.

→ **These safety warnings apply only for lithium-ion batteries of the POWER FOR ALL system PBA 18V.**

→ **Only use the battery with products of the POWER FOR ALL system manufacturers.**
This is the only way in which you can protect the battery against dangerous overload.

→ **Recharge only with the charger specified by the manufacturer.**
A charger that is suitable for one type of battery pack may create a risk of fire when used with another battery pack.

→ **The battery is supplied partially charged.**
To ensure full battery capacity, fully charge the battery in the charger before using your power tool for the first time

→ **Keep battery packs out of the reach of children.**

→ **Do not open the battery.** There is a risk of short-circuiting.

→ **In case of damage and improper use of the battery, vapours may be emitted. The battery can set alight or explode.**
Ensure the area is well ventilated and seek medical attention should you experience any adverse effects. The vapours may irritate the respiratory system.

→ **If used incorrectly or if the battery is damaged, flammable liquid may be ejected from the battery. Contact with this liquid should be avoided. If contact accidentally occurs, rinse off with water. If the liquid comes into contact with your eyes, seek additional medical attention.**
Liquid ejected from the battery may cause irritation or burns.

→ **If the battery is damaged liquid can be ejected and cover nearby surfaces. Check affected parts.** Clean these parts or change them if necessary.

→ **Do not short-circuit the battery pack. When the battery pack is not in use, keep it away from other metal objects, like paper clips, coins, keys, nails, screws or other small metal objects, that can make a connection from one terminal to another.**
Shorting the battery terminals together may cause burns or a fire.

→ **The battery contacts can be hot after use. Be careful of the hot contacts when removing the battery.**

→ **The battery can be damaged by pointed objects such as nails or screwdrivers or by force applied externally.** An internal short circuit may occur, causing the battery to burn, smoke, explode or overheat.

→ **Never service damaged battery packs.** Service of battery packs should only be performed by the manufacturer or authorized service providers.

→  **Protect the battery against heat, e.g. against continuous intense sunlight, fire, dirt, water and moisture.**
There is a risk of explosion and short-circuiting.

→ **Only operate and store the battery at an ambient temperature between -20 °C and +50 °C.**
Do not leave the battery in your car in the summer, for example.
At temperatures of <0 °C some devices may experience a loss of power.

→ **Only charge the battery at an ambient temperature which is between 0 °C and +45 °C.**
Charging outside of this temperature range can increase the risk of damage to the battery and pose a fire hazard.

→ **After use, allow the battery to cool down for at least 30 minutes before charging or storing.**

Electrical safety

 **DANGER! Cardiac arrest!**

This product makes an electromagnetic field while it operates. This field may under some conditions interfere with active or passive medical implants. To decrease the risk of conditions that can possibly injure or kill, we recommend persons with medical implants to speak with their physician and the medical implant manufacturer before you operate the product.

Remove the safety key before transportation.
Always remove the battery before storage.
Only use the battery product between 0 °C to 40 °C.
Do not use under wet conditions.

Personal safety

 **DANGER! Risk of suffocation!**

Small parts can be easily swallowed. There is also a risk that the poly-bag can suffocate toddlers. Keep toddlers away when you assemble the product.

Don't open the protective flap while mowing.

Don't reach through openings while using the mower.

Never cut grass by pulling the mower towards you.

Only use original spare parts.

Only start the mower when the handle is in the intended working position.

Do not use the start levers alternately.

Do not disassemble the product further than the delivery status.

Use gloves, wear slip resistant shoes and wear eye protection.

Do not overload the mower.

Never operate the product when you are tired, ill or under the influence of alcohol, drugs or medicine.

Danger of slipping:

- in wet grass
 - on steep slopes
 - during transport
- Be careful while going backwards.

2. ASSEMBLY

 **DANGER! Risk of injury!**
Cut injury when the product starts accidentally.

→ **Wait for the blade to stop, remove the battery, remove the safety key and use gloves before you assemble the product.**

To assemble the handle [Fig. A1/A2/A3]:

1. Put the springs ① on the shafts ②.
2. Put the handle plates ③ on the shafts ②.
3. Put the lower handle ④ on the shafts ②.
4. Put the washers ⑤ on the shafts ② and align with handle plate recess.
5. Insert the bolts ⑥ into the quick-release levers ⑦.
6. Screw the quick-release levers ⑦ loosely onto the shafts ② and clamp them down.
7. Put the upper handle ⑧ on the lower handle ④ and slide the screws ⑨ through the boreholes (there are 2 holes in the lower handle to choose the desired height).
8. Put the washers ⑤ on the screws ⑨.
9. Screw the locking nuts ⑩ onto the screws.
10. Attach the control cable ⑪ with the cable clips ⑫.

To assemble the grass box [Fig. A4/A5/A6/A7/A8]:

1. Push the grass box handle ⑬ into the slots (with the hook opposite the grass inlet) in the grass box cover ⑭ until it audibly engages.
2. Slide the grass box tongue ⑮ into the slots in the grass box ⑯ until it audibly engages.
3. Align the grass box cover ⑭ and the grass box locators ⑰.
4. Fold the grass box cover ⑭ towards the grass box ⑯.
5. Push the grass box cover ⑭ on the grass box ⑯. Make sure that all clips are snapped in correctly.

To attach the grass box to the lawnmower [Fig. A9]:

1. Lift the protective flap ⑱.
2. Attach the grass box ⑯ to the hooks ⑲ on the rear of the mower by the handle ⑲.
Make sure that the grass box is securely connected.

3. OPERATION



DANGER! Risk of injury!

Cut injury when the product starts accidentally.

→ Wait for the blade to stop, remove the battery, remove the safety key and use gloves before you adjust or transport the product.

To charge the battery [Fig. O1/O2/O3]:



CAUTION!

→ Note the mains voltage! The voltage of the power source must match the voltage specified on the rating plate of the charger.

For the FLYMO Battery Mower Art. 970538201/970538401 there is no battery and no charger in the scope of delivery.

Thanks to the intelligent charging process, the charge condition of the battery is automatically detected and then charged up with the optimal charge current depending on battery temperature and voltage.

In this way, the battery is treated with care and remains permanently fully charged when it is stored in the charger.

1. Open the battery cover (9).
2. Push the locking button (A) and remove the battery (B) from the battery holder (D).
3. Connect the battery charger (C) into a mains socket.
4. Slide the battery charger (C) onto the battery (B).

When the battery charge indicator (L) at the charger flashes green the battery is being charged.

When the battery charge indicator (L) at the charger illuminates permanently green the battery is completely charged (Charging time, see 7. TECHNICAL DATA).

5. Examine the charge status regularly while you charge.
6. When the battery (B) is completely charged, you can disconnect the battery (B) from the charger (C).

Meaning of the Indication Elements:

Indication on the charger [Fig. O3]:

Flashing of the battery charge indicator (L) The charging procedure is indicated by **flashing** of the battery charge indicator (L).



Note: The charging procedure is only possible when the battery temperature is within the allowable charging temperature range, see 7. TECHNICAL DATA.

Continuous lighting of the battery charge indicator (L)



Continuous lighting of the battery charge indicator (L) indicates that the battery is fully charged or that the temperature of the battery is not within the allowable charging temperature range and can therefore not be charged.

When the battery is not inserted, **continuous lighting** of the battery charge indicator (L) indicates that the mains plug is inserted in the socket outlet and that the battery charger is ready for operation.

Battery charge status indication (P) on the product [Fig. O4/O5]:

After starting the product, the battery charge status indication (P) is displayed for 5 seconds.

Battery charge status	Battery charge status indication
67 – 100 % charged	(L), (L) and (L) illuminate green
34 – 66 % charged	(L) and (L) illuminate green
11 – 33 % charged	(L) illuminates green
0 – 10 % charged	(L) flashes green

If the LED (L) flashes green, the battery must be charged.

If the error LED (M) is illuminated or flashing, see 6. TROUBLESHOOTING.

To adjust the cutting height (in 5 positions) [Fig. O6]:

The cutting height can be adjusted from 20 – 60 mm (from rear to front).

Position 1 (20 mm): Cutting height setting should only be used on well maintained *manicured lawns* without excessive moss or thatch.

Position 2 (30 mm): Cutting height setting is the suitable for most lawns.

Position 3 (40 mm): Cutting height setting is the suitable for most lawns.

Position 4 (50 mm): Cutting height setting is the suitable for most lawns.

Position 5 (60 mm): Cutting height setting is used when your lawn has excessive growth such as following holidays or first cut of the season.

1. Pull the lever (23) out towards the wheel.
2. Move the lever (23) to the desired position.
3. Release the lever (23) in the corresponding notch and let it engage.

To use the mower with the grass box [Fig. A9/O7]:



DANGER! Risk of injury!

Cut injury when the blade turns or the mower starts accidentally.

→ Wait for the blade to stop, remove the safety key and use gloves before you open the protective flap.

→ Do not put your hands in the discharge opening.

1. Attach the grass box to the lawnmower (see 2. ASSEMBLY).
2. Start the mower.

The level indicator (24) opens during mowing. When it closes during mowing, the grass box is full.

3. Stop the mower.
4. Lift the protective flap (17).
5. Remove the grass box (16) by the handle (12).
6. Empty the grass box (16).

To start the mower [Fig. O1/O5]:



DANGER! Risk of injury!

Risk of injury if the product does not stop when you release the start levers.

→ Do not bypass the safety devices or switches. For example do not attach the start levers to the handle.

To start:

The product is provided with a two-handed safety device (start lever and safety interlock) to prevent the product from being turned on by accident.

There are two start levers (22). Either one has to be used to start.

We recommend not to use 2 batteries of different capacity.

1. Open the battery cover (9).
2. Put the batteries (B) into the battery holder (D) until they audibly engage.
3. Put the safety key (20) into the mower and turn it to position I.
4. Push the safety interlock (21) with one hand and pull the start lever (22) with the other hand.
The mower starts.
5. Release the safety interlock (21).

To stop:

1. Release the start lever (22).
The mower stops.
2. Turn the safety key (20) to position 0 and remove it.

Tips to use the mower:

If grass residue is left in the discharge opening, pull the mower backwards about 1 m so that the grass residue can drop out downwards.

To produce a well-maintained lawn and optimise the cutting performance, we recommend to cut the lawn regularly once a week if possible. The lawn becomes denser if you cut it frequently.

After relatively long cutting intervals (holiday lawn), first of all cut in one direction with the highest cutting height and then cut in the crosswise direction with the required cutting height.

If possible, only cut the grass when it is dry, if the grass is damp, the cutting pattern will be uneven.

Cutting performance and battery charge:

The lawn area which can be cut on each battery charge depends on several factors such as moisture, grass density and cutting height. In order to ensure an optimal use of space, do not turn the mower on and off too frequently as this severely reduces the battery running time. The

cutting performance for each battery charge can be ideally utilised by increasing the cutting height and frequent mowing.

Rear Roller:

For lawnmowers fitted with a rear roller, it is possible to create a striped effect on the lawn. For the best stripe results, we recommend cutting on the lowest possible cutting height suited to your lawn. The stripe effect will fade in time between cuts.

Transport position [Fig. O8]:

The easy transport position provides additional mobility due to its upright driving position. Easy to get on and off the lawn at any distance.

1. Attach the grass box (16) to the switch box (25) (see 5. STORAGE).
2. Pull the mower to and from the lawn when it is set in the storage position.

4. MAINTENANCE



DANGER! Risk of injury!

Cut injury when the product starts accidentally.

- Wait for the blade to stop, remove the battery, remove the safety key and use gloves before you maintain the product.

To clean the mower:



DANGER! Risk of injury!

Risk of injury and risk of damage to the product.

- Do not clean the product with water or with a water jet (in particular high-pressure water jet).
- Do not clean with chemicals including petrol or solvents. Some can destroy critical plastic parts.

The airflow slots must always be clean.

To clean the underside of the mower:

The underside is easiest to clean after you mowed.

1. Lay the mower on its side carefully.
2. Clean the underside, the blade and the discharge opening (24) with a brush (do not use sharp objects).

To clean the overside of the mower and the grass box:

1. Clean the overside with a damp cloth.
2. Clean the airflow slots and the grass box with a soft brush (do not use sharp objects).

To clean the battery and the battery charger:

Make sure that the surface and the contacts of the battery and the battery charger always are clean and dry before you connect the battery charger.

Do not use running water.

- **Battery charger:** Clean the contacts and the plastic parts with a soft and dry cloth.
- **Battery:** Occasionally clean the ventilation slots and the terminals on the battery using a soft brush that is clean and dry.

5. STORAGE

To put into storage:

The product must be stored away from children.

1. Turn the safety key to position 0 and remove it.
2. Remove the batteries.
3. Charge the batteries.
4. Clean the mower, the batteries and the battery charger (see 4. MAINTENANCE).

Store the mower, the batteries and the battery charger in a dry, enclosed and frost-free place.

Easi Storage position: Upright [Fig. S1/S2]:

Store the mower at a flat surface to avoid tipping.

1. Remove the grass box (see 3. OPERATION).
2. Set on the highest cutting height (see 3. OPERATION).
3. Release the lower quick-release levers (7) and fold the handle (8) down.
4. Stand the mower upright.
5. Make sure that the grass box (16) is completely empty.
6. Attach the grass box (16) to the switch box (25) with the storage hook (26). Make sure that the grass box (16) is completely secured, the storage function is accomplished.
7. Store the mower in upright position.

Disposal:

(in accordance with RL2012/19/EC/S.I. 2013 No. 3113)



The product must not be disposed of to normal household waste. It must be disposed of in line with local environmental regulations.

IMPORTANT!

- Dispose of the product through or via your municipal recycling collection centre.

Disposal of the battery:



The battery contains lithium-ion cells that should not be disposed of with normal household waste at the end of its life.

Li-ion

IMPORTANT!

- Dispose of the batteries through or via your municipal recycling collection centre.

1. Discharge the lithium-ion cells completely (contact the FLYMO Service).
2. Protect the contacts on the lithium-ion cells against short circuits.
3. Dispose of the lithium-ion cells properly.

6. TROUBLESHOOTING



DANGER! Risk of injury!

Cut injury when the product starts accidentally.

- Wait for the blade to stop, remove the battery, remove the safety key and use gloves before you troubleshoot the product.

To replace the blade [Fig. T1]:



DANGER! Risk of injury!

Cut injury when the blade turns and it is damaged, bent, out of balance or has chipped edges.

- Do not use the mower when the blade is damaged, bent, out of balance or has chipped edges.
- Do not regrind the blade.

The FLYMO spare parts are available from your FLYMO dealer or from the FLYMO service.

Only use an original FLYMO blade:

- FLYMO replacement blade for 340R:
Art. FLY087/PNC: 599134690
- FLYMO replacement blade for 380R:
Art. FLY099/PNC: 536119290

1. Insert a screwdriver through one of the holes in the spacer (31) into the reinforced hole on the deck to stop the motor shaft from turning.
2. Unscrew the blade bolt (27). Take care not to damage the spacer (31) when applying force.
3. Remove the blade bolt (27) and the washer (28).
4. Remove the blade (29).
5. Put the new blade (29) on the mower.
6. Put the washer (28) and the blade bolt (27) on the mower.

- Screw the new blade ⑳ tight with the blade bolt ㉑. Tightening torque is 15 – 20 Nm. Do not over-torque.
- Take care not to damage the spacer ㉒ when applying force. Make sure that the screwdriver is removed before attempting to start the mower.

Problem	Possible Cause	Remedy
Engine is jammed and makes a noise	Motor is blocked.	→ Remove the obstacle.
	Cutting height is too low.	→ Raise the cutting height.
Loud noises, the mower is rattling	Screws on engine, its fixing or on the mower chasing are loose.	→ Let the screws be tightened by an authorised specialist dealer or the FLYMO Service.
Mower runs unevenly or vibrates strongly	Blade is damaged/worn or the blade mounting is released.	→ Replace the blade.
	Blade is very dirty.	→ Clean the blade.
Lawn is not cleanly mowed	Blade is blunt or damaged.	→ Replace the blade.
	Cutting height is too low.	→ Raise the cutting height.
Mower does not start or stops. LED ㉓ is flashing green [Fig. 04]	Battery is empty.	→ Charge the battery.
Mower does not start or stops. Error-LED ㉔ is illuminated red [Fig. 04]	Battery temperature is outside the permissible temperature range.	→ Wait until the battery temperature is between 0 °C – + 45 °C again.
	There are drops of water or moisture between the battery contacts on the mower.	→ Remove the water drops/moisture with a dry cloth.
	Motor is blocked.	→ Remove the obstacle. Start again.
Mower does not start or stops. Error-LED ㉕ is flashing red [Fig. 04]	Product is defective.	→ Contact the FLYMO Service.
Mower does not start or stops. Error-LED ㉖ is not illuminated [Fig. 04]	Battery is not put completely into the battery holder.	→ Put the battery completely into the battery holder until it audibly engages.
	Battery is defective.	→ Replace the battery.
	Product is defective.	→ Contact the FLYMO Service.
Charging is not possible. Battery charge indicator ㉗ is continuously illuminated [Fig. 03]	The battery is not connected (correctly).	→ Connect the battery to charger correctly.
	Battery contacts are dirty.	→ Clean the battery contacts (e.g. by connecting and disconnecting the battery several times. Replace the battery if necessary.
	Battery temperature is outside the permissible charging temperature range.	→ Wait until the battery temperature is between 0 °C – + 45 °C again.
	Battery is defective.	→ Replace the battery.
Battery charge indicator ㉘ is not illuminated [Fig. 03]	Mains plug of the charger is not (correctly) plugged in.	→ Insert the mains plug into the mains socket (completely).
	Socket outlet, mains cable or charger is defective.	→ Check the mains voltage. Let the charger be checked if necessary by an authorised specialist dealer or the FLYMO Service.



For any other malfunctions please contact the Husqvarna UK Ltd. Customer Service. Repairs must only be done by Husqvarna UK Ltd. service departments or specialist dealers approved by FLYMO.

7. TECHNICAL DATA

Battery Lawnmower	Unit	Value Art. 9705382-xx/ 9705383-xx	Value Art. 9705384-xx/ 9705385-xx
Speed of rotation cutting blade	R/min	3,300	3,300
Cutting width	cm	34	38
Cutting height adjustment (5 positions)	mm	20 – 60	20 – 60
Volume of grass box	l	35	45
Weight (without Battery)	kg	10.6	11.8

Battery Lawnmower	Unit	Value Art. 9705382-xx/ 9705383-xx	Value Art. 9705384-xx/ 9705385-xx
Sound pressure level L_{pA} ¹⁾ Uncertainty k_{pA}	dB (A)	75 3.0	77 3.0
Sound power level L_{WA} ²⁾ : measured/guaranteed Uncertainty k_{WA}	dB (A)	86 / 87 1.1	89 / 90 0.7
Hand / arm vibration a_{vhw} ¹⁾ Uncertainty k_{vhw}	m/s ²	0.7 1.5	0.5 1.5

Measuring process complying with: ¹⁾ EN 60335-2-77 ²⁾ RL 2000/14/EC/S.I. 2001 No.1701



NOTE: The stated vibration emission value has been measured according to a standardised test procedure and can be used for comparison of one electric power tool with another. It can also be used for preliminary evaluation of exposure. The vibration emission value can vary during actual use of the electric power tool.

System Battery PBA 18V 2.0Ah W-B	Unit	Value (Art. 970544201)
Battery voltage	V (DC)	18
Battery capacity	Ah	2.0
Number of cells (Li-Ion)		5

Appropriate POWER FOR ALL system Battery Chargers: AL 1810 CV/AL 1815 CV/AL 1830 CV/AL 1880 CV.

Battery Charger AL 1810 CV P4A	Unit	Value (Art. 531382201)
Mains voltage	V (AC)	220 – 240
Mains frequency	Hz	50 – 60
Rated power	W	26
Battery charging voltage	V (DC)	18
Max. battery charging current	mA	1000
Battery charging time 80 % / 97 – 100 % (approx.)		
PBA 18V 2.0Ah W-B	min.	96 / 124
PBA 18V 2.5Ah W-B	min.	120 / 154
PBA 18V 4.0Ah W-C	min.	192 / 244
Permitted charging temperature range	°C	0 – 45
Weight according to EPTA-Procedure 01:2014	kg	0.17
Protection class		□ / II

Appropriate POWER FOR ALL system Batteries: PBA 18V.

8. ACCESSORIES

FLYMO System Battery PBA 18V/45 P4A PBA 18V/72 P4A	Battery for additional duration or for replacement.	Art. 531382601 Art. 531382701
FLYMO Battery Charger AL 1810 CV P4A	Charger for the POWER FOR ALL system Batteries PBA 18V..W-..	Art. 531382201
FLYMO Replacement Blade for 36 V EasiStore 340R	As replacement for blunt blade.	Art. FLY087/ PNC: 599134690
FLYMO Replacement Blade for 36 V EasiStore 380R	As replacement for blunt blade.	Art. FLY099/ PNC: 536119290

9. SERVICE/WARRANTY

Service:

Please contact the address on the back page.

Warranty statement:

In the event of a warranty claim, no charge is levied to you for the services provided.

Husqvarna UK Ltd. grants a warranty for all original FLYMO new products for 3 years* from the date of original purchase from the retailer, provided that the devices have been for private use only. This manufacturer's warranty does not apply to products acquired second hand. This warranty includes all significant defects of the product that can be proved to be

material or manufacturing faults. This warranty is fulfilled by supplying a fully functional replacement product or by repairing the faulty product sent to us free of charge; we reserve the right to choose between these options. This service is subject to the following provisions:

- The product has been used for its intended purpose as per the recommendations in the operating instructions.
- Neither the purchaser nor a third party has attempted to open or repair the product.
- Only Original FLYMO replacement parts and wear parts have been used for operation.
- Presentation of the receipt.

Normal wear and tear of parts and components (such as blades, blade fixing parts, turbines, light bulbs, V-belts/toothed belts, impellers, air filters, spark plugs), visual changes, wear parts and consumables are excluded from the warranty.

This manufacturer's warranty is limited to replacement and repair of products in accordance with the abovementioned conditions. The manufacturer's warranty does not constitute an entitlement to lodge other claims against us as a manufacturer, such as for damages. This manufacturer's warranty does **not**, of course, affect statutory and contractual warranty claims against the dealer/retailer.

The manufacturer's warranty is governed by the law of the Federal Republic of Germany.

In case of a warranty claim, please return the faulty product, together with a copy of the receipt and a description of the fault, with postage paid to the service address.







(* Upon register)

Consumables:

The blade and the wheels are consumables and are not included in the warranty.

EN Product liability

In accordance with the German Product Liability Act, we hereby expressly declare that we accept no liability for damage incurred from our products where said products have not been properly repaired by a FLYMO-approved service partner or where original FLYMO parts or parts authorised by FLYMO were not used.

EN EC Declaration of Conformity The undersigned hereby certifies as the authorised representative of the manufacturer, Husqvarna AB, 561 82 Huskvarna, Sweden, that, when leaving our factory, the unit(s) indicated below is/are in accordance with the harmonised EU guidelines, EU standards of safety and product specific standards. This certificate becomes void if the unit(s) is/are modified without our approval.													
Description of the Product:	Battery Lawnmower												
Product type:	36V EasiStore 340R 36V EasiStore 380R												
Article Number:	9705382-xx 9705383-xx 9705384-xx 9705385-xx												
EC-Directives:	2006/42/EC 2014/30/ EU 2000/14/EC 2011/65/ EU												
Harmonised EN:	EN ISO 12100 EN 60335-1 EN 60335-2-77 EN 62841-1 EN 62841-4-3												
EC-type-examination:	DEKRA Testing and Certification GmbH Handwerkstraße 15 70565 Stuttgart												
Number of notified body:	0158												
Deposited Documentation:	GARDENA Technical Documentation, M. Jäger, 89079 Ulm												
Conformity Assessment Procedure:	according to 2000/14/EC Art. 14 Annex VI												
Noise level:	<table><thead><tr><th></th><th>measured</th><th>/</th><th>guaranteed</th></tr></thead><tbody><tr><td>Art. 9705382-xx/9705383-xx:</td><td>86 dB (A)</td><td>/</td><td>87 dB (A)</td></tr><tr><td>Art. 9705384-xx/9705385-xx:</td><td>89 dB (A)</td><td>/</td><td>90 dB (A)</td></tr></tbody></table>		measured	/	guaranteed	Art. 9705382-xx/9705383-xx:	86 dB (A)	/	87 dB (A)	Art. 9705384-xx/9705385-xx:	89 dB (A)	/	90 dB (A)
	measured	/	guaranteed										
Art. 9705382-xx/9705383-xx:	86 dB (A)	/	87 dB (A)										
Art. 9705384-xx/9705385-xx:	89 dB (A)	/	90 dB (A)										
Year of CE marking:	2021												
Ulm, 31.12.2021 Authorised Representative:	<table><tr><td> Reinhard Pompe Vice President Products</td><td> Wolfgang Engelhardt Vice President Supply Chain</td></tr></table>	 Reinhard Pompe Vice President Products	 Wolfgang Engelhardt Vice President Supply Chain										
 Reinhard Pompe Vice President Products	 Wolfgang Engelhardt Vice President Supply Chain												

EN UKCA Declaration of Conformity

The manufacturer: Husqvarna AB SE 561 82 Huskvarna, Sweden hereby certifies, when leaving our factory, the unit(s) indicated below is/are in accordance with the UK Regulations, designated standards of safety and product specific designated standards. This certificate becomes void if the units are modified without our approval.

Description of the Product:	Battery Lawnmower			
Product type:	36V EasiStore 340R 36V EasiStore 380R			
Article Number:	9705382-xx 9705383-xx 9705384-xx 9705385-xx			
Serial number & year of construction:	Serial Number dating 2021 and onwards			
UK regulations:	S.I. 2008/1597 S.I. 2016/1091 S.I. 2012/3032 S.I. 2001/1701			
Designated Standards:	EN ISO 12100 EN 60335-1 EN 60335-2-77 EN 62841-1 EN 62841-4-3			
Conformity assessment body:	Intertek Testing & Certification Ltd. Academy Place, 1-9 Brook Street, Brentwood, Essex, CM14 5NQ, United Kingdom			
Number of notified body:	0359			
Authorised Representative:	Husqvarna UK Limited			
Deposited Documentation:	Preston Road, Aycliffe, County Durham UK DL5 6 UP			
Noise level:		measured	/	guaranteed
	Art. 9705382-xx/9705383-xx:	86 dB (A)	/	87 dB (A)
	Art. 9705384-xx/9705385-xx:	89 dB (A)	/	90 dB (A)
Conformity Assessment Procedure:	according to S.I. 2001/1701 Art. 11 Schedule 9			
Aycliffe, 31.12.2021 Authorised Representative:	 John Thompson Director			

Service Address and Importer to

Great Britain

Husqvarna UK Ltd
Preston Road
Aycliffe Industrial Park
Newton Aycliffe
County Durham
DL5 6UP
Phone: +44 (0) 344 8444558
customer.services@husqvarna.co.uk



22341-85.960.01/1121
Husqvarna AB
Drottninggatan 2
SE-561 82 Huskvarna
Sweden

Our policy of continuous improvement means that the specification of products may be altered from time to time without prior notice.
Copyright © 2021 Flymo S.A. All rights reserved.
Flymo® and other product and feature names are registered or unregistered trademarks of Flymo S.A.