

EasyCut 40/18V P4A

Art. 14733

**EN Operator's manual**  
Battery Hedge Trimmer

---



**01**

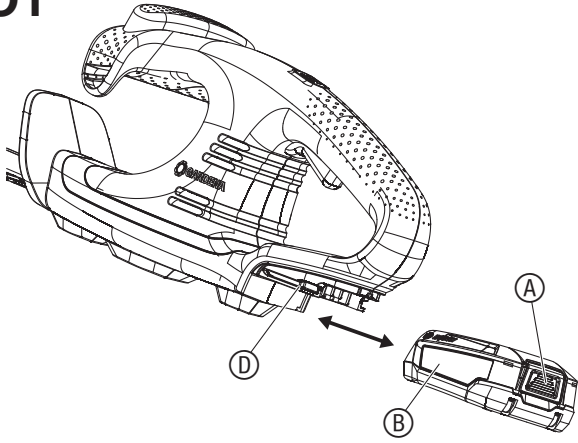

**02**

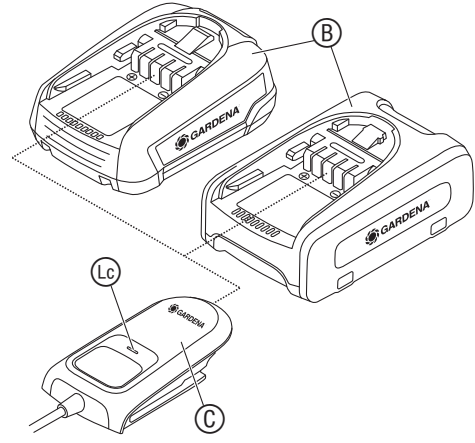

**03**

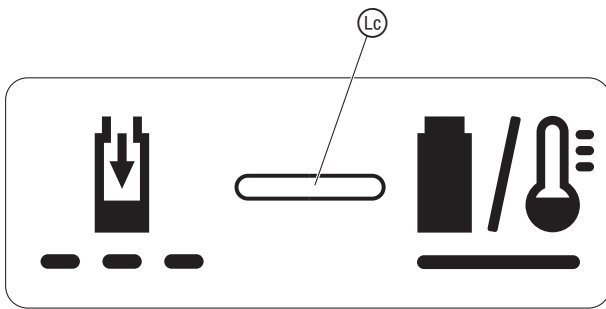

**04**

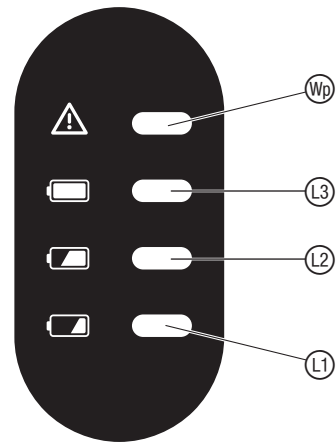

**05**

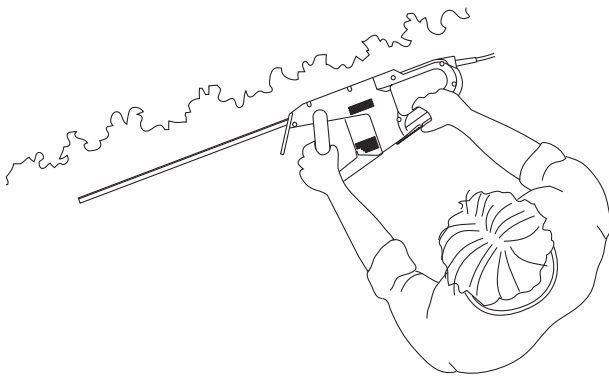

**06**

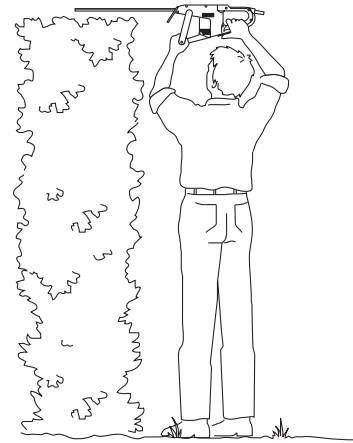

**07**

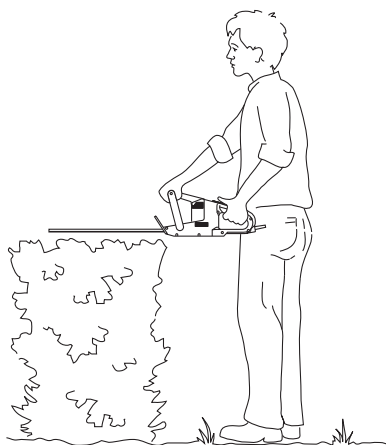

**08**

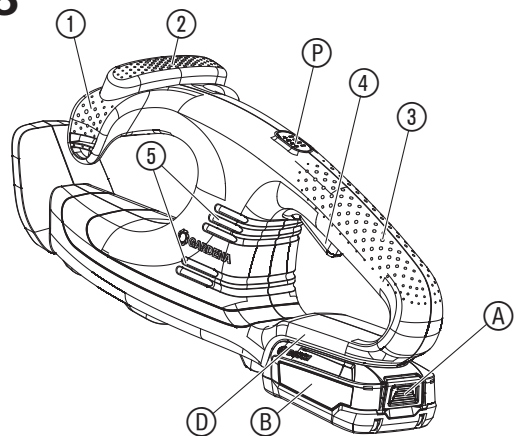

## EN Battery Hedge Trimmer

1. SAFETY .....	8
2. OPERATION .....	10
3. MAINTENANCE .....	11
4. STORAGE .....	11
5. TROUBLESHOOTING .....	12
6. TECHNICAL DATA .....	12
7. ACCESSORIES .....	12
8. SERVICE/WARRANTY .....	12

### Translation of the original instructions.



This product is not intended for use by persons (including children) with reduced physical, sensory or mental capabilities, or lack of experience and knowledge, unless they have been given supervision or instruction concerning use of the product by a person responsible for their safety. Children should be supervised to ensure that they do not play with the product. The use of this product by young people under the age of 16 is not recommended.

### Intended use:

The **GARDENA Hedge Trimmer** is intended to cut hedges, shrubs and grass coverings in private domestic gardens and allotments.

The product is not intended for long term use.



**DANGER! Risk of physical injury!**

→ Do not use the product to cut lawns/lawn edges, to chop up material or to make compost.

## 1. SAFETY

### IMPORTANT!

Read the operator's manual carefully before use and keep for future reference.

## Symbols on the product:



Read operator's manual.



Danger – Keep hands away from blade.



Do not expose to rain.



For the charger:  
Remove plug from the mains immediately if the cable is damaged or cut.



Wear eye and ear protection.



Remove the Battery before cleaning or maintenance.

## General safety warnings

### General machine safety warnings



#### WARNING!

Read all safety warnings, instructions, illustrations and specifications provided with this machine. Failure to follow the warnings and instructions may result in electric shock, fire and/or serious injury.

Save all warnings and instructions for future reference.

The term "machine" in the warnings refers to your mains operated (corded) machine or battery operated (cordless) machine.

#### 1) Work area safety

- a) Keep work area clean and well lit. Cluttered or dark areas invite accidents.
- b) Do not operate machines in explosive atmospheres, such as in the presence of flammable liquids, gases or dust. Machines create sparks which may ignite the dust or fumes.
- c) Keep children and bystanders away while operating a machine. Distractions can cause you to lose control.

#### 2) Electrical safety

- a) Machine plugs must match the outlet. Never modify the plug in any way. Do not use any adaptor plugs with earthed (grounded) machines. Unmodified plugs and matching outlets will reduce risk of electric shock.
- b) Avoid body contact with earthed or grounded surfaces, such as pipes, radiators, ranges and refrigerators. There is an increased risk of electric shock if your body is earthed or grounded.
- c) Do not expose machines to rain or wet conditions. Water entering a machine will increase the risk of electric shock.
- d) Do not abuse the cord. Never use the cord for carrying, pulling or unplugging the machine. Keep cord away from heat, oil, sharp edges or moving parts. Damaged or entangled cords increase the risk of electric shock.
- e) When operating a machine outdoors, use an extension cord suitable for outdoor use. Use of a cord suitable for outdoor use reduces the risk of electric shock.
- f) If operating a machine in a damp location is unavoidable, use a residual current device (RCD) protected supply. Use of an RCD reduces the risk of electric shock.

#### 3) Personal safety

- a) Stay alert, watch what you are doing and use common sense when operating a machine. Do not use a machine while you are tired or under the influence of drugs, alcohol or medication. A moment of inattention while operating machines may result in serious personal injury.
- b) Use personal protective equipment. Always wear eye protection. Protective equipment such as dust mask, non-skid safety shoes, hard hat, or hearing protection used for appropriate conditions will reduce personal injuries.
- c) Prevent unintentional starting. Ensure the switch is in the OFF-position before connecting to power source and/or battery pack, picking up or carrying the machine. Carrying machines with your finger on the switch or energising machines that have the switch on invites accidents.
- d) Remove any adjusting key or wrench before turning the machine on. A wrench or a key left attached to a rotating part of the machines may result in personal injury.
- e) Do not overreach. Keep proper footing and balance at all times. This enables better control of the machine in unexpected situations.
- f) Dress properly. Do not wear loose clothing or jewellery. Keep your hair, clothing and gloves away from moving parts. Loose clothes, jewellery or long hair can be caught in moving parts.
- g) If devices are provided for the connection of dust extraction and collection facilities, ensure these are connected and properly used. Use of dust collection can reduce dust-related hazards.

h) Do not let familiarity gained from frequent use of machines allow you to become complacent and ignore machine safety principles. A careless action can cause severe injury within a fraction of a second.

#### 4) Machine use and care

- a) Do not force the machine. Use the correct machine for your application. The correct machine will do the job better and safer at the rate for which it was designed.
- b) Do not use the machine if the switch does not turn it on and off. Any machine that cannot be controlled with the switch is dangerous and must be repaired.
- c) Disconnect the plug from the power source and/or the battery pack from the machine before making any adjustments, changing accessories, or storing machines. Such preventive safety measures reduce the risk of starting the machine accidentally.
- d) Store idle machines out of the reach of children and do not allow persons unfamiliar with the machine or these instructions to operate the machine. Machines are dangerous in the hands of untrained users.
- e) Maintain machines. Check for misalignment or binding of moving parts, breakage of parts and any other condition that may affect the machine's operation. If damaged, have the machine repaired before use. Many accidents are caused by poorly maintained machines.
- f) Keep cutting tools sharp and clean. Properly maintained cutting tools with sharp cutting edges are less likely to bind and are easier to control.
- g) Use the machine, accessories and tool bits etc. in accordance with these instructions, taking into account the working conditions and the work to be performed. Use of the machine for operations different from those intended could result in a hazardous situation.
- h) Keep handles and grasping surfaces dry, clean and free from oil and grease. Slippery handles and grasping surfaces do not allow for safe handling and control of the machine in unexpected situations.

#### 5) Battery tool use and care

- a) Recharge only with the charger specified by the manufacturer. A charger that is suitable for one type of battery pack may create a risk of fire when used with another battery pack.
- b) Use machines only with specifically designated battery packs. Use of any other battery packs may create a risk of injury and fire.
- c) When battery pack is not in use, keep it away from other metal objects, like paper clips, coins, keys, nails, screws or other small metal objects, that can make a connection from one terminal to another. Shorting the battery terminals together may cause burns or a fire.
- d) Under abusive conditions, liquid may be ejected from the battery; avoid contact. If contact accidentally occurs, flush with water. If liquid contacts eyes, additionally seek medical help. Liquid ejected from the battery may cause irritation or burns.
- e) Do not use a battery pack or tool that is damaged or modified. Damaged or modified batteries may exhibit unpredictable behavior resulting in fire, explosion or risk of injury.
- f) Do not expose a battery pack or tool to fire or excessive temperature. Exposure to fire or temperature above 130 °C may cause explosion.
- g) Follow all charging instructions and do not charge the battery pack or tool outside the temperature range specified in the instructions. Charging improperly or at temperatures outside the specified range may damage the battery and increase the risk of fire.

#### 6) Service

- a) Have your machine serviced by a qualified repair person using only identical replacement parts. This will ensure that the safety of the machine is maintained.
- b) Never service damaged battery packs. Service of battery packs should only be performed by the manufacturer or authorised service providers.

#### Hedge trimmer safety warnings

- a) Keep all parts of the body away from the blade. Do not remove cut material or hold material to be cut when blades are moving. Blades continue to move after the switch is turned off. A moment of inattention while operating the hedge trimmer may result in serious personal injury.
- b) Carry the hedge trimmer by the handle with the blade stopped and taking care not to operate any power switch. Proper carrying of the hedge trimmer will decrease the risk of inadvertent starting and resultant personal injury from the blades.
- c) When transporting or storing the hedge trimmer, always fit the blade cover. Proper handling of the hedge trimmer will decrease the risk of personal injury from the blades.
- d) When clearing jammed material or servicing the unit, make sure all power switches are off and the battery pack is removed or disconnected. Unexpected actuation of the hedge trimmer while clearing jammed material or servicing may result in serious personal injury.
- e) Hold the hedge trimmer by insulated gripping surfaces only, because the blade may contact hidden wiring. Blades contacting a "live" wire may make exposed metal parts of the hedge trimmer "live" and could give the operator an electric shock.
- f) Keep all power cords and cables away from cutting area. Power cords or cables may be hidden in hedges or bushes and can be accidentally cut by the blade.
- g) Do not use the hedge trimmer in bad weather conditions, especially when there is a risk of lightning. This decreases the risk of being struck by lightning.

Search hedges and bushes for hidden objects (e.g. wire fences and hidden wires).

The use of a residual current device (RCD) with a trip current of 30 mA or less is recommended.

Hold the hedge trimmer with both hands on both handles.

The hedge trimmer is intended for use when the user is standing on the ground and not on a ladder or other unstable surface.

## Additional safety warnings

### Battery safety



**Read all the safety and general instructions.**

Failure to observe the safety and general instructions may result in electric shock, fire and/or serious injury.

**Store these instructions in a safe place.**

Only use the charger if you can fully evaluate all functions and carry them out without restrictions, or if you have received corresponding instructions.

→ **Supervise children during use, cleaning and maintenance.**

This will ensure that children do not play with the charger.

→ **Charge only lithium-ion batteries of the POWER FOR ALL system type PBA 18V with a capacity of 1.5 Ah or more (5 battery cells or more). The battery voltage must match the battery charging voltage of the charger. Do not charge any non rechargeable batteries.**

Otherwise there is a risk of fire and explosion.

→ **Do not expose the charger to rain or wet conditions.**



Water entering a power tool will increase the risk of electric shock.

→ **Keep the charger clean.** Dirt poses a risk of electric shock.

→ **Always check the charger, cable and plug before use. Stop using the charger if you discover any damage. Do not open the charger yourself, and have it repaired only by a qualified specialist using only original replacement parts.**

Damaged chargers, cables and plugs increase the risk of electric shock.

→ **Do not operate the charger on an easily ignited surface (e.g. paper, textiles, etc.) or in a flammable environment.**

There is a risk of fire due to the charger heating up during operation.

→ In order to avoid safety hazards, if the power supply cord needs to be replaced, this must be done by GARDENA or by a customer service centre that is authorised to repair GARDENA power tools.

→ **Do not operate the product while it is charging.**

**Products sold in GB only:** Your product is fitted with an BS 1363/A approved electric plug with internal fuse (ASTA approved to BS 1362). If the plug is not suitable for your socket outlets, it should be cut off and an appropriate plug fitted in its place by an authorised customer service agent. The replacement plug should have the same fuse rating as the original plug. The severed plug must be disposed of to avoid a possible shock hazard and should never be inserted into a mains socket elsewhere.

→ **These safety warnings apply only for lithium-ion batteries of the POWER FOR ALL system PBA 18V.**

→ **Only use the battery with products of the POWER FOR ALL system manufacturers.** This is the only way in which you can protect the battery against dangerous overload.

→ **Recharge only with the charger specified by the manufacturer.**

A charger that is suitable for one type of battery pack may create a risk of fire when used with another battery pack.

→ **The battery is supplied partially charged.**

To ensure full battery capacity, fully charge the battery in the charger before using your power tool for the first time.

→ **Keep battery packs out of the reach of children.**

→ **Do not open the battery.** There is a risk of short-circuiting.

→ **In case of damage and improper use of the battery, vapours may be emitted. The battery can set alight or explode.**

Ensure the area is well ventilated and seek medical attention should you experience any adverse effects. The vapours may irritate the respiratory system.

→ **If used incorrectly or if the battery is damaged, flammable liquid may be ejected from the battery. Contact with this liquid should be avoided. If contact accidentally occurs, rinse off with water. If the liquid comes into contact with your eyes, seek additional medical attention.**

Liquid ejected from the battery may cause irritation or burns.

→ **If the battery is damaged liquid can be ejected and cover nearby surfaces. Check affected parts.** Clean these parts or change them if necessary.

→ **Do not short-circuit the battery pack. When the battery pack is not in use, keep it away from other metal objects, like paper clips, coins, keys, nails, screws or other small metal objects, that can make a connection from one terminal to another.**

Shorting the battery terminals together may cause burns or a fire.

→ **The battery contacts can be hot after use. Be careful of the hot contacts when remove the battery.**

→ **The battery can be damaged by pointed objects such as nails or screwdrivers or by force applied externally.** An internal short circuit may occur, causing the battery to burn, smoke, explode or overheat.

→ **Never service damaged battery packs.**

Service of battery packs should only be performed by the manufacturer or authorized service providers.

→ **Protect the battery against heat, e.g. against continuous intense sunlight, fire, dirt, water and moisture.**



There is a risk of explosion and short-circuiting.

→ **Only operate and store the battery at an ambient temperature between -20 °C and +50 °C.** Do not leave the battery in your car in the summer, for example. At temperatures of <0 °C some devices may experience a loss of power.

→ **Only charge the battery at an ambient temperature which is between 0 °C and +45 °C.** Charging outside of this temperature range can increase the risk of damage to the battery and pose a fire hazard.

→ **After use, allow the battery to cool down for at least 30 minutes before charging or storing.**

### Electrical safety



**DANGER! Cardiac arrest!**

**This product makes an electromagnetic field while it operates. This field may under some conditions interfere with active or passive medical implants. To decrease the risk of conditions that can possibly injure or kill, we recommend persons with medical implants to speak with their physician and the medical implant manufacturer before you operate the product.**

Remove battery in case of emergency.

Only use the battery product between -10 °C and 40 °C.

Thoroughly inspect the area where the product is to be used and remove all wires and other foreign objects.

In case of an unintended start (e.g. due to a welded switch) disconnect the battery immediately from device and let the product repaired by the GARDENA service.

Disconnect the product from the mains and disconnect the battery if the product starts to vibrate abnormally. Check immediately. Excessive vibration can cause injury.

Do not use the product near water.

Do not operate next to swimming pools or garden ponds.

Protect the electrical contacts of the battery from moisture.

### Personal safety



**DANGER! Risk of suffocation!**

**Small parts can be easily swallowed. There is also a risk that the polybag can suffocate toddlers. Keep toddlers away when you assemble the product.**

Know how to stop the product quickly in an emergency.

Avoid contact with the oil of the blade, allergic reaction is possible.

Only work in the daylight or when visibility is good.

Check your product before each use. Always visually inspect your Hedge Trimmer before each use. Check that the ventilation slots are not obstructed in any way.

If the product gets hot whilst in operation, let it cool down before storage.

Warning! When wearing hearing protection, and due to the noise produced by the product, the operator may not notice persons approaching.

Always wear suitable clothing, protective gloves, and stout shoes.

Always ensure that you have a secure foothold whilst working.

## 2. OPERATION



**DANGER! Risk of physical injury!**

**Cut injury when the product starts accidentally.**

→ **Wait for the blade to stop, remove the battery and slide the protective cover over the blade before you transport the product.**

### To charge the battery [Fig. 01/02/03]:



**CAUTION!**

**Note the mains voltage!** The voltage of the power source must match the voltage specified on the rating plate of the charger.

**For the GARDENA Battery Hedge Trimmer Art. 14733-55 there is no battery and no charger in the scope of delivery.**



Thanks to the intelligent charging process, the charge condition of the battery is automatically detected and then charged up with the optimal charge current depending on battery temperature and voltage.

In this way, the battery is treated with care and remains permanently fully charged when it is stored in the charger.

1. Push the locking button (A) and remove the battery (B) from the battery holder (D).
2. Connect the battery charger (C) into a mains socket.
3. Slide the battery charger (C) onto the battery (B).

**When the battery charge indicator (E) at the charger flashes green the battery is being charged.**

When the battery charge indicator  at the charger illuminates permanently green the battery is completely charged (Charging time, see 6. TECHNICAL DATA).

- Examine the charge status regularly while you charge.
- When the battery  is completely charged, you can disconnect the battery  from the charger .

### Meaning of the indication elements:

#### Indication on the charger [Fig. O3]:

**Flashing of the Battery Charge Indicator ** The charging procedure is indicated by flashing of the battery charge indicator .



**Note:** The charging procedure is only possible when the battery temperature is within the allowable charging temperature range, see 6. TECHNICAL DATA.

**Continuous Lighting of the Battery Charge Indicator **







**Continuous lighting** of the battery charge indicator  indicates that the battery is fully charged or that the temperature of the battery is not within the allowable charging temperature range and can therefore not be charged.



When the battery is not inserted, **continuous lighting** of the battery charge indicator  indicates that the mains plug is inserted in the socket outlet and that the battery charger is ready for operation.

#### Battery charge status indication on the product [Fig. O4/O8]:

After starting the product, the battery charge status indication  is displayed for 5 seconds.

Battery charge status	Battery charge status indication
67 – 100 % charged	 ,  and  illuminate green
34 – 66 % charged	 and  illuminate green
11 – 33 % charged	 illuminates green
0 – 10 % charged	 flashes green

If the LED  flashes green, the battery must be charged.

If the error LED  is illuminated or flashing, see 5. TROUBLESHOOTING.

#### Work positions:

The hedge trimmer can be operated in 3 positions.

- Side trimming [Fig. O5]
- High trimming [Fig. O6]
- Low trimming [Fig. O7]

#### To start the hedge trimmer [Fig. O1/O8]:









**DANGER! Risk of physical injury!**

**Risk of injury if the product does not stop when you release the start levers.**

→ Do not bypass the safety devices or switches. For example do not attach the start levers to the handle.





#### To start:

The product is provided with a two-handed safety device (2 start levers) to prevent the product from being turned on by accident.

- Put the battery  into the battery holder  until it audibly engages.
- Remove the protective cover from the blade.
- Hold the front handle  with one hand and pull the front start lever .
- Hold the main handle  with the other hand and pull the rear start lever .

The hedge trimmer starts and the battery charge status indication  is displayed for 5 seconds.

#### To stop:

- Release the two start levers /.
- Slide the protective cover over the blade.
- Push the locking button  and remove the battery  from the battery holder .

## 3. MAINTENANCE



**DANGER! Risk of physical injury!**

**Cut injury when the product starts accidentally.**

→ Wait for the blade to stop, remove the battery and slide the protective cover over the blade before you maintain the product.

#### To clean the Hedge Trimmer [Fig. O8]:



**DANGER! Risk of physical injury!**

**Risk of injury and risk of damage to the product.**

→ Do not clean the product with water or with a water jet (in particular high-pressure water jet).

→ Do not clean with chemicals including petrol or solvents. Some can destroy critical plastic parts.

#### The airflow slots must always be clean.

- Clean the hedge trimmer with a damp cloth.
- Clean the airflow slots  with a soft brush (do not use a screwdriver).
- Lubricate the blade with a low viscosity oil (e.g. GARDENA Maintenance Oil Art. 2366).  
Avoid contact with the plastic parts.

#### To clean the battery and the battery charger:

Make sure that the surface and the contacts of the battery and the battery charger always are clean and dry before you connect the battery charger.

#### Do not use running water.

→ **Battery charger:** Clean the contacts and the plastic parts with a soft and dry cloth.

→ **Battery:** Occasionally clean the ventilation slots and the terminals on the battery using a soft brush that is clean and dry.

## 4. STORAGE

#### To put into storage:

#### The product must be stored away from children.

- Slide the protective cover over the blade.
- Remove the battery.
- Charge the battery.
- Clean the hedge trimmer, the battery and the battery charger (see 3. MAINTENANCE).
- Store the hedge trimmer, the battery and the battery charger in a dry, enclosed and frost-free place.

#### Disposal:

(in accordance with RL2012/19/EC/S.I. 2013 No. 3113)



The product must not be disposed of to normal household waste. It must be disposed of in line with local environmental regulations.

#### IMPORTANT!

→ Dispose of the product through or via your municipal recycling collection centre.

#### Disposal of the battery:



The battery contains lithium-ion cells that should not be disposed of with normal household waste at the end of its life.

#### IMPORTANT!

→ Dispose of the batteries through or via your municipal recycling collection centre.

- Discharge the lithium-ion cells completely (contact the GARDENA Service).
- Protect the contacts on the lithium-ion cells against short circuits.
- Dispose of the lithium-ion cells properly.







## 5. TROUBLESHOOTING



**DANGER! Risk of physical injury!**

**Cut injury when the product starts accidentally.**

→ Wait for the blade to stop, remove the battery and slide the protective cover over the blade before you troubleshoot the product.

Problem	Possible Cause	Remedy
Hedge trimmer can no longer be stopped	Start lever is stuck.	→ Remove the battery and loosen the start lever.
Hedge is not cleanly cut	Blade is blunt or damaged.	→ Let the blade be replaced by the GARDENA Service.
Hedge trimmer vibrates severely	Blade is damaged.	→ Switch off the product and let the blade be replaced.
Hedge trimmer does not start or stops. LED  is flashing green [Fig. 04]	Battery is empty.	→ Charge the battery.
Hedge trimmer does not start or stops. Error-LED  is illuminated red [Fig. 04]	Battery temperature is outside the permissible temperature range.	→ Wait until the battery temperature is between 0 °C – +45 °C again.
	There are drops of water or moisture between the battery contacts on the hedge trimmer.	→ Remove the water drops/moisture with a dry cloth.
	Engine is blocked.	→ Remove the obstacle. Start again.
Hedge trimmer does not start or stops. Error-LED  is flashing red [Fig. 04]	Product is defective.	→ Contact the GARDENA Service.
Hedge trimmer does not start or stops. Error-LED  is not illuminated [Fig. 04]	Battery is not put completely into the battery holder.	→ Put the battery completely into the battery holder until it audibly engages.
	Battery is defective.	→ Replace the battery.
	Product is defective.	→ Contact the GARDENA Service.
Charging is not possible. Battery charge indicator  is continuously illuminated [Fig. 03]	The battery is not connected (correctly).	→ Connect the battery to charger correctly.
	Battery contacts are dirty.	→ Clean the battery contacts (e.g. by connecting and disconnecting the battery several times. Replace the battery if necessary.
	Battery temperature is outside the permissible charging temperature range.	→ Wait until the battery temperature is between 0 °C – +45 °C again.
Battery is defective.		→ Replace the battery.
	Battery is defective.	→ Replace the battery.
Battery charge indicator  is not illuminated [Fig. 03]	Mains plug of the charger is not (correctly) plugged in.	→ Insert the mains plug into the mains socket (completely).
	Socket outlet, mains cable or charger is defective.	→ Check the mains voltage. Let the charger be checked if necessary by an authorised specialist dealer or the GARDENA Service.



**NOTE: For any other malfunctions please contact the GARDENA service department. Repairs must only be done by GARDENA service departments or specialist dealers approved by GARDENA.**

## 6. TECHNICAL DATA

Battery Hedge Trimmer	Unit	Value (Art. 14733)
Strokes	1/min	2400
Length of blade	cm	40
Tooth gap of blade	mm	16
Weight (without Battery)	g	1890
Sound pressure level $L_{pA}$ <sup>1)</sup>	dB (A)	77
Uncertainty $k_{pA}$		3.0
Sound power level $L_{WA}$ <sup>2)</sup> : measured/guaranteed	dB (A)	86 / 88
Uncertainty $k_{WA}$		2.3

Battery Hedge Trimmer	Unit	Value (Art. 14733)
Hand/arm vibration $a_{vhw}$ <sup>1)</sup>	m/s <sup>2</sup>	1.3
Uncertainty $k_{vhw}$		1.5

Measuring process complying with: <sup>1)</sup> 62841-4-2 <sup>2)</sup> RL 2000/14/EC / S.I. 2001 No.1701



**NOTE: The stated vibration emission value has been measured according to a standardised test procedure and can be used for comparison of one electric power tool with another. It can also be used for preliminary evaluation of exposure. The vibration emission value can vary during actual use of the electric power tool.**

System Battery PBA 18V 2.0Ah W-B	Unit	Value (Art. 14902)
Battery voltage	V (DC)	18
Battery capacity	Ah	2.0
Number of cells (Li-Ion)		5

Appropriate POWER FOR ALL system Battery Chargers: AL 1810 CV / AL 1815 CV / AL18-20 / AL 1830 CV / AL 1880 CV.

Battery Charger AL 1810 CV P4A	Unit	Value (Art. 14900)
Mains voltage	V (AC)	220 – 240
Mains frequency	Hz	50 – 60
Rated power	W	26
Battery charging voltage	V (DC)	18
Max. battery charging current	mA	1000
Battery charging time 80% / 97 – 100% (approx.)		
PBA 18V 2,0Ah W-B	min.	96 / 124
PBA 18V 2,5Ah W-B	min.	120 / 154
PBA 18V 4,0Ah W-C	min.	192 / 244
Permitted charging temperature range	°C	0 – 45
Weight according to EPTA-Procedure 01:2014	kg	0.17
Protection class		□ / II

Appropriate POWER FOR ALL system Batteries: PBA 18V.

## 7. ACCESSORIES

GARDENA Maintenance Oil	Extends the life of the blade and the battery idling time.	Art. 2366
GARDENA System Battery PBA 18V/45 P4A PBA 18V/72 P4A	Battery for additional duration or for replacement.	Art. 14903 Art. 14905
GARDENA Battery Quick Charger AL 1830 CV P4A	Charger for fast charging the POWER FOR ALL System Batteries PBA 18V..W-..	Art. 14901

## 8. SERVICE/WARRANTY

### Service:

Please contact the address on the enclosed warranty card.

### Warranty statement:

The warranty is only granted according to the warranty conditions printed on the enclosed warranty card.

### Consumables:

The blade and eccentric drive are consumables and are not included in the warranty.



<p><b>DE EU-Konformitätserklärung</b> Der Unterzeichnende bestätigt als Bevollmächtigter des Herstellers, der GARDENA Germany AB, PO Box 7454, S-103 92, Stockholm, Schweden, dass das (die) nachfolgend bezeichnete(n) Geräte(s) in der von uns in Verkehr gebrachten Ausführung die Anforderungen der harmonisierten EU-Richtlinien, EU-Sicherheitsstandards und produktspezifischen Standards erfüllt/erfüllen. Bei einer nicht mit uns abgestimmten Änderung des (der) Geräte(s) verliert diese Erklärung ihre Gültigkeit.</p>	<p><b>HU EU megfeleléségi nyilatkozat</b> Az alulírott, a GARDENA Germany AB, Pf. 7454, S-103 92, Stockholm, Svédország megbízotti minőségében megerősíti, hogy az általunk alábbi kivitelben forgalomba hozott, lent nevezett eszköz(ök) megfelel(nek) az unióis irányelvekkel összhangban hozott nemzeti előírások követelményeinek, az EU biztonsági szabványainak és a konkrét termékre vonatkozó szabványoknak. Az eszköz(ök)nek minden megjelölt módosítás esetén ez a nyilatkozat érvényét veszti.</p>
<p><b>EN EC Declaration of Conformity</b> The undersigned hereby certifies as the authorized representative of the manufacturer, GARDENA Germany AB, PO Box 7454, S-103 92, Stockholm, Sweden, that, when leaving our factory, the unit(s) indicated below is/are in accordance with the harmonised EU guidelines, EU standards of safety and product specific standards. This certificate becomes void if the unit(s) is/are modified without our approval.</p>	<p><b>CS EU prohlášení o shodě</b> Podpisem osoba plnomocněná výrobcem GARDENA Germany AB, PO Box 7454, S-103 92, Stockholm, Švédsko potvrzuje, že v následujícím uvedený(-é) přístroj(-e) v provedení námi uvedeném na trh splňuje/splňují požadavky směrnice EU, bezpečnostních norem EU a norem specifických pro výrobek. V případě změny přístroje(-ů), která s námi nebyla dohodnuta, ztrácí toto prohlášení svou platnost.</p>
<p><b>FR Déclaration de conformité CE</b> Le soussigné déclare, en tant que mandataire du fabricant, la GARDENA Germany AB, PO Box 7454, S-103 92, Stockholm, Suède, qu'à la sortie de ses usines le matériel nelé désigné ci-dessous était conforme aux prescriptions des directives européennes énoncées ci-après et conforme aux règles de sécurité et autres règles qui lui sont applicables dans le cadre de l'Union européenne. Toute modification portée sur ce(s) produit(s) sans l'accord express de notre part supprime la validité de ce certificat.</p>	<p><b>SK EÚ vyhlásenie o zhode</b> Dolú podpísaný potvrdzuje, ako splnomocnený zástupca výrobcu, GARDENA Germany AB, PO Box 7454, S-103 92, Stockholm, Švédsko, potvrdzuje, že ďalej označené zariadenie/a vo vyhotovení uvedenom na trh spĺňa/jú požiadavky harmonizovaných smerníc EU, bezpečnostných štandardov EÚ a predpisov, špecifických pre dané výrobky. Pri zmene zariadenia/zariadení, ktorá nebola odsúhlasená našou spoločnosťou, stráca toto vyhlásenie platnosť.</p>
<p><b>NL EU-conformiteitsverklaring</b> De ondergetekende bevestigt als gevolmachtigde van de fabrikant, GARDENA Germany AB, PO Box 7454, S-103 92, Stockholm, Zweden, dat het/ de onderstaand vermelde apparaat/apparaten in de door ons in de handel gebrachte uitvoering voldoet/voldoen aan de eisen van de geharmoniseerde EU-richtlijnen, EU-veiligheidsnormen en productspecifieke normen. Bij een niet met ons afgestemde verandering van het apparaat/de apparaten verliest deze verklaring haar geldigheid.</p>	<p><b>EL Δήλωση συμμόρφωσης ΕΕ</b> Ο υπογεγραμμένος βεβαιώνει ως πληρεξούσιος του κατασκευαστή, της εταιρείας GARDENA Germany AB, T.Θ. 7454, S-103 92, Στοκχόλμη, Σουηδία, ότι η(οι) παρακάτω αναφερόμενη(ς) συσκευή(ές) στην έκδοσή που τίθεται από εμάς σε κυκλοφορία πληροί/πληρούν τις απαιτήσεις των ενωμοποιημένων οδηγιών της ΕΕ, προτύπων ασφαλείας της ΕΕ και των ειδικών για το προϊόν προτύπων. Σε περίπτωση τροποποίησης της (των) συσκευής(ών) χωρίς προηγούμενη συνεννόηση με την εταιρεία μας παύει να ισχύει η δήλωση.</p>
<p><b>SV EU-försäkran om överensstämmelse</b> Undertecknad intygar som befulldäktad företrädare för tillverkaren, GARDENA Germany AB, PO Box 7454, S-103 92, Stockholm, Sverige, att nedan angiven apparat/ nedan angivna apparater i det utförande vi har släppt på marknaden, uppfyller förordningarna i de harmoniserade EU-direktiv, EU-säkerhetsstandarderna och de produktspecifika standarderna. Denna försäkran upphör att gälla vid en ändring av apparaten/apparaterna som inte har stämts av med oss.</p>	<p><b>SL Izjava EU o skladnosti</b> Spodaj podpisani kot pooblaščenec proizvajalca GARDENA Germany AB, PO Box 7454, S-103 92, Stockholm, Švedska, potrjuje, da v nadaljevanju označene naprave v izvedbi, v kakršni smo jih dali v promet, izpolnjuje zahteve usklajenih direktiv EU, varnostnega standarda EU in standardov, ki veljajo za posamezne izdelke. V primeru spremembe naprave, ki ni usklajena z nami, ta izjava neha veljati.</p>
<p><b>DA EU-overensstemmelseserklæring</b> Underskriveren bekræfter som fuldmægtig for producenten, GARDENA Germany AB, PO Box 7454, S-103 92, Stockholm, Sverige, at det (de) efterfølgende betegnede apparat(er) i den af os markedsførte udførelse opfylder kravene i de harmoniserede EU-direktiver, EU-sikkerhedsstandarder og produktspecifikke standarder. Foretages en ændring af apparatet/apparaterne, der ikke er aftalt med os, mister denne erklæring sin gyldighed.</p>	<p><b>HR EU izjava o sukladnosti</b> Dolje potpisani kao ovlaštenik proizvođača, tvrtke GARDENA Germany AB, PO Box 7454, S-103 92, Stockholm, Švedska, potvrđuje da nize naznačene uređaj(i) odgovaraju izvedbe koji/koje smo iznijeli na tržište ispunjavaju kriterije uskladenih direktiva EU i sigurnosnih standarda EU kao i standarda koji se tiču proizvoda. Ova izjava gubi valjanost u slučaju izmjena uređaja koje nisu prethodno ugovorene s nama.</p>
<p><b>FI EU-vaatimustenmukaisuusvakuutus</b> Allekirjoittanut vahvistaa valmistajan, GARDENA Germany AB, PO Box 7454, S-103 92, Tukholma, Ruotsi, valtuuttamansa henkilöä, että seuraava laite täyttää/ seuraavat laitteet täyttävät meidän toimittamassa mallissa yhdenmukaistettujen EU-direktiivien, EU-turvallisuusmääräysten ja tuotekohtaisen standardien vaatimukset. Laitteen/ laitteiden muutoksissa, joista ei ole sovittu meidän kanssamme, menettää tämä selvitys voimassolonsa.</p>	<p><b>RO Declarație de conformitate UE</b> Semnatul, în calitate sa de împuternicit al producătorului GARDENA Germany AB, PO Box 7454, S-103 92, Stockholm, Suedia, confirmă că aparatul (aparatele) descrise în cele ce urmează, în execuția pusă de noi pe piață îndeplinesc cerințele directivei armonizate UE, ale standardelor de siguranță UE și ale standardelor specifice produsului. În cazul modificării fără aprobarea noastră prealabilă a aparatului (aparateror), această declarație își pierde valabilitatea.</p>
<p><b>IT Dichiarazione di conformità UE</b> Il sottoscritto, in quanto soggetto autorizzato dal produttore, GARDENA Germany AB, PO Box 7454, S-103 92, Stoccolma, Svezia, dichiara che l'apparecchio/gli apparecchi di seguito denominati/i, nella versione da noi immessa in commercio, soddisfa/ no i requisiti delle direttive UE armonizzate, degli standard di sicurezza europei e degli standard specifici per il prodotto. La presente dichiarazione perde di validità in caso di modifica dell'apparecchio/ degli apparecchi non concordata con noi.</p>	<p><b>BG ЕС-Декларация за съответствие</b> Долноподписаният удостоверява като пълномощник на производителя GARDENA Germany AB, PO Box 7454, S-103 92, Стокхолм, Швеция, че по-долу описаният(ите) уред(и) във варианта на изпълнение пунат от нас на пазара изпълнява/ изпълняват изискванията на хармонизираните ЕС-директиви, ЕС-норми за безопасност и специфичните норми за продукцията. В случай на промяна на уред(ите), която не е съгласувана с нас, тази декларация губи своята валидност.</p>
<p><b>ES Declaración de conformidad de la UE</b> El firmante confirma, en calidad de apoderado del fabricante GARDENA Germany AB, PO Box 7454, S-103 92 Estocolmo (Suecia), que el/ los aparato(s) mencionado(s) a continuación cumple(n), en la versión lanzada al mercado por nuestra empresa, los requisitos de las directivas de la UE armonizadas, los estándares de seguridad de la UE y los estándares específicos del producto. La presente declaración perderá su validez si se modifica(n) el/ los aparato(s) sin previa aprobación por nuestra parte.</p>	<p><b>ET EL-i vastavusdeklaratsioon</b> Allakirjutajana kinnitab tootja, GARDENA Germany AB, PO Box 7454, S-103 92, Stockholm, Rootsi, poolt volitatud isikuna, et järgnevalt nimetatud seade (seadmed) täidab (täidavad) seadme poolt turule toodud versiooni kuul harmoniseeritud EL-i direktiivide, EL-i ohutusstandardite ja tooteühiste standardite nõuded. Seadme (seadmete) meiega kooskõlastamata muudatuse tegemise korral kaotab käesolev deklaratsioon oma kehtivuse.</p>
<p><b>PT Declaração CE de Conformidade</b> O abaixo-assinado, na qualidade de representante do fabricante, GARDENA Germany AB, PO Box 7454, S-103 92, Stockholm, Schweden, confirma que o(s) aparelho(s) a seguir designado(s) no modelo lançado por nós no mercado cumpre/ cumprem os requisitos das diretivas UE harmonizadas, as normas de segurança UE e as normas específicas para estes produtos. Esta declaração perde a sua validade se forem realizadas alterações no(s) aparelho(s) sem o nosso consentimento.</p>	<p><b>LT ES atitikties deklaracija</b> Pasirašantis, kaip gamintojo, GARDENA Germany AB, PO Box 7454, S-103 92, Stokholmas, Švedija, įgaliotasis atstovas patvirtina, kad žemiau nurodyti(-ų) prietaisai(-ų) modeliai, kurie buvo pagaminti mūsų gamykloje, atitinka darniasias ES direktyvas, ES saugumo standartus ir specifinius gaminių standartus. Atlikus bet koki prietaisai(-ų) pakeitimą, kuris nėra suderintas su mumis, ši deklaracija praranda galiojimą.</p>
<p><b>PL Deklaracja zgodności UE</b> Nижéj podpisany potwierdza jako upoważniony przedstawiciel producenta, spółki GARDENA Germany AB, PO Box 7454, S-103 92, Stokholm, Szwecja, że określone poniżej urządzenie/-nia w wersji wprowadzonej przez nas do obrotu spełnia/ -niają wymogi zharmonizowanych dyrektyw UE, norm bezpieczeństwa UE oraz norm dotyczących konkretnych produktów. Niniejsza deklaracja traci ważność w przypadku wprowadzania niezgodnych z nami zmian urządzenia/-ń.</p>	<p><b>LV ES atbilstības deklarācija</b> Lēmā parakstījis persona kā ražotāja, GARDENA Germany AB, PO Box 7454, S-103 92, Stokholma, Zviedrija, pilnvarotais pārstāvis apstiprina, ka tālāk norādītā(-s) ierīce(-s) izpildījuma, kādā mēs to (tās) esam laidusi tirgū, atbilst skaidrotajām ES direktīvam, ES drošības standartiem un konkrētiem produktām noteiktiem standartiem. Ierīce(-s) veicot ar mums nesaskaņotas izmaiņas, šī deklarācija zaudē savu spēku.</p>

<p>Produktbezeichnung: Description of the product: Désignation du produit : Beschrijving van het product: Beskrivning av produkten: Beskrivelse af produktet: Tuotteen kuvaus: Descrizione del prodotto: Descripción del producto: Descrição do produto: Opis produktu: A termék leírása: Popis výrobku: Popis produktu: Περιγραφή του προϊόντος: Opis izdelka: Opis proizvoda: Descrierea produsului: Описание на продукта: Toote kirjeldus: Gaminio aprašas: Izstrādājuma apraksts:</p>	<p><b>Akku-Heckenschere</b> <b>Battery Hedge Trimmer</b> <b>Taille-haies à batterie</b> <b>Accu-heggenschaar</b> <b>Accu-häcksax</b> <b>Hækkeklipper med genopladelig accu</b> <b>Akkukäyttöinen pensasleikkuri</b> <b>Tagliasièpi a batteria</b> <b>Recortasetos con Accu</b> <b>Corta sebas a batería</b> <b>Akumulatorowe nożyce do żywoplotu</b> <b>Akkumulatorové nůžky na živý plot</b> <b>Akumulatorové nožnice na živý plot</b> <b>Μπρωτοουροαίλιδο μπαταρίας</b> <b>Akumulatorske škare za živo mejo</b> <b>Baterijske škare za živicu</b> <b>Trimmer de gard viu cu baterie</b> <b>Акумулаторна ножица за жив плет</b> <b>Akuga hekkilõikur</b> <b>Akkumulatorinés gyvatvorių žirkklės</b> <b>Ar akumulatoru darbināmas dzīvzoga šķēres</b></p>	<p>Harmonisierte EN-Normen / Harmonised EN:  Schall-Leistungspegel: gemessen/ garantiert Noise level: measured/ guaranteed Niveau sonore : mesuré/ garanti Geluksniveaui: gremet/ gegarandėerd Ljudnivå: uppmätt/ garanterad Støjniveau: målt/ garanteret Äänitaso: mitattu/ taattu Livello acustico: misurato/ garantito Nivel de ruido: medido/ garantizado Nivel de ruido: medido/ garantido Poziom hałas: zmierzony/ gwarantowany Zajszint: mért/ garantált Hladina hluku: naměřená/ zaručená</p> <p>Anbringningsjahr der CE-Kennzeichnung: Year of CE marking: Année d'apposition du marquage CE : Installatiejaar van de CE-aanduiding: Märkningsår: CE-Märkningsår: CE-merkin kiinnitysvuosi: Anno di applicazione della certificazione CE: Colocación del distintivo CE: Ano de marcação pela CE: Rok nadania oznakowania CE:</p> <p>Ul m, den 15.03.2022 Ul m, 15.03.2022 Fait à Ul m, le 15.03.2022 Ul m, 15-03-2022 Ul m, 2022.03.15 Ul m, 15.03.2022 Umissa, 15.03.2022 Ul m, 15.03.2022 Ul m, 15.03.2022 Ul m, dnia 15.03.2022 Ul m, 15.03.2022 Ul m, 15.03.2022 Ul m, 15.03.2022 Ul m, 15.03.2022 Ul m, 15.03.2022 Ul m, 15.03.2022 Ul m, 15.03.2022 Ul m, 15.03.2022 Ul m, 15.03.2022</p> <p>Der Bevollmächtigte Authorised representative Le mandataire De gevolmachtigde Auktoriserad representant Autoriseret repræsntant Valtuutettu edustaja Persona delegata La persona autorizada O representante Pelnomocnik Meghatalmazott Zplnomocnènc Splnomocnený O ερουσιοδοτημένος Pooblaščenec Ovlaštena osoba Conducerea tehnică Упълномощен Volitatu esindaja Igalotias atstovas Pilnvarotā persona</p> <p><b>EN ISO 12100</b> <b>EN 62841-1</b> <b>EN 62841-4-2</b></p> <p>namerané/zaručené μετρημένο/εγγυημένο izmerjena/ zagotovljena mjerena/ zajamčena mäsurat/ garantat измерено/ гарантирано mõõdetud/ garanteeritud mērotats/ garantuojamas isrēmatas/ garantētais</p> <p><b>86 dB(A) / 88 dB(A)</b></p> <p><b>2022</b></p>
<p>Produkttyp: Product type: Type de produit: Producttype: Producttype: Producttype: Tuotetyyppi: Tipo adi prodotto: Tipo de producto: Tipo de produto: Typ produktu:</p> <p>Terméktípus: Druh výrobku: Typ de produit: Typo προϊόντος: Vrsta izdelka: Vrsta proizvoda: Tip produs: Тип продукт: Tootetüüp: Gaminio tipas: Produkta veids:</p> <p><b>2006/42/EG</b> <b>Direktive EU:</b> <b>2011/65/EU</b> <b>EC direktive:</b> <b>2014/30/EU</b> <b>Direktive CE:</b> <b>2014/30/EU</b> <b>Директиви на EO:</b> <b>2014/30/EU</b> <b>EU direktiivid:</b></p>	<p>Artikelnummer: Article number: Réfèrence : Artikelnummer: Artikelnummer: Artikelnummer: Tuotennumero: Codice articolo: Referencia: Número de referência: Numer katalogowy:</p> <p>Cikkszámok: Objednací číslo: Objednávacie číslo: Κωδικός είδους: Številka izdelka: Kataloški broj: Cod article: Артикул номер: Artiklinummer: Dahies numeris: Artikula numurs:</p> <p>Hinterlegte Dokumentation: GARDENA Technische Dokumentation, M. Jäger, 89079 Ulm</p> <p>Conformity Assessment Verfahren: Nach 2000/14/EG Art. 14 Anhang V</p> <p>Conformity Assessment Procedure: according to 2000/14/EG Art. 14 Annex V</p> <p>Documentation déposée : Documentation technique GARDENA, M. Jäger, 89079 Ulm</p> <p>Procédure d'évaluation de la conformité : Selon 2000/14/CE art. 14 Annexe V</p>	<p>Reinhard Pompe Vice President</p> <p>Wolfgang Engelhardt Vice President Supply Chain</p>

**EN UKCA Declaration of Conformity**

The manufacturer: GARDENA Germany AB, PO Box 7454, S-103 92 Stockholm, Sweden hereby certifies, when leaving our factory, the unit(s) indicated below is/are in accordance with the UK Regulations, designated standards of safety and product specific designated standards. This certificate becomes void if the units are modified without our approval.

Description of the Product: **Battery Hedge Trimmer**

Product type: **EasyCut 40/18V P4A**

Article Number: **14733**

UK regulations: **S.I. 2008/1597  
S.I. 2016/1091  
S.I. 2012/3032  
S.I. 2001/1701**

Designated Standards: **EN ISO 12100  
EN 62841-1  
EN 62841-4-2**

Authorised Representative: **Husqvarna UK Limited**

Deposited Documentation: **Preston Road,  
Aycliffe,  
County Durham  
UK  
DL5 6 UP**

Conformity Assessment Procedure: **According to S.I. 2001/1701 Art. 11 Schedule 8**

Noise level: measured / guaranteed **86 dB(A) / 88 dB(A)**

Aycliffe, 15.03.2022

Authorised Representative:



**John Thompson**  
Director

**Deutschland / Germany**

GARDENA Manufacturing GmbH  
Central Service  
Hans-Lorenser-Straße 40  
D-89079 Ulm  
Produktfragen:  
(+49) 731 490-123  
Reparaturen:  
(+49) 731 490-290  
www.gardena.com/de/kontakt

**Albania**

KRAFT SHPK  
Autostrada Tirane-Durres  
Km 7  
1051 Tirane  
Phone: (+355) 69 877 7821  
info@kraft.al

**Argentina**

ROBERTO C. RUMBO S.R.L.  
Predio Nortog  
Lote 7  
Benavidez, ZC: 1621  
Buenos Aires  
Phone: (+54) 11 5263-7862  
ventas@rumbosrf.com.ar

**Armenia**

AES Systems LLC  
Marshal Babajanyan Avenue 56/2  
0022 Yerevan  
Phone: (+374) 60 651 651  
massohanyan@cloud.com

**Australia**

Husqvarna Australia Pty. Ltd.  
Locked Bag 5  
Central Coast BC  
NSW 2252  
Phone: (+61) (0) 2 4352 7400  
customer.service@husqvarna.com.au

**Austria / Österreich**

Husqvarna Austria GmbH  
Industriezeile 36  
4010 Linz  
Tel.: (+43) 732 77 01 01-485  
service.gardena@husqvarnagroup.com

**Azerbaijan**

Progres Xüsusi Firmas  
Aliyar Aliyev 212, Baku, Azerbaijan  
Sales: +994 70 326 07 14  
Aftersales: +994 77 326 07 14  
www.progress-garden.az  
info@progress-garden.az

**Bahrain**

M.H. Al-Mahroos  
BUILDING 208, BLOCK 356,  
ROAD 328  
Salhiya  
Phone: +973 1740 8090  
almahroos@almahroos.com

**Belarus / Беларусь**

ООО «Мастер Гарден»  
220118, г. Минск,  
улица Шаранговича, дом 7а  
Тел.: (+375) 17 257 00 33  
mg@mastergarden.by

**Belgium**

Husqvarna Belgium nv  
Gardena Division  
Leuvensesteenweg 542  
Planet II E  
1930 Zaventem  
België

**Bosnia / Hercegovina**

Silk Trade d.o.o.  
Postovna Zona Vila Br. 20  
Phone: (+387) 61 165 593  
info@silktrade.com.ba

**Brazil**

Nordtech Maquinas e Motores Ltda.  
Avenida Juscelino Kubitschek  
de Oliveira Curitiba  
3003 Brazil  
Phone: (+55) 41 3595-9600  
contato@nordtech.com.br  
www.nordtech.com.br

**Bulgaria**

AGROLAND България АД  
бул. 8 Декември, № 13  
Офис 5  
1700 Студентски град  
София  
Тел.: (+359) 24 66 6910  
info@agroland.eu

**Canada / USA**

GARDENA Canada Ltd.  
125 Edgeware Road  
Unit 15 A  
Brampton L6Y 0P5  
ON, Canada  
Phone: (+1) 905 792 93 30  
gardena.customerservice@husqvarnagroup.com

**Chile**

REPRESENTACIONES JCE S.A.  
AV. DEL VALLE NORTE 857 PISO 4  
HUECHURABA, SANTIAGO, CHILE  
Phone: (+56) 2 2414 2600  
contacto@jca.cl

**China**

Husqvarna (Shanghai)  
Management Co., Ltd.  
富世华 (上海) 管理有限公司  
3F, Beng Square B,  
No 207, Song Hong Rd.,  
Chang Ning District,  
Shanghai, PRC. 200335  
上海市长宁区崧虹路207号明  
基广场3楼3楼, 邮编: 200335

**Colombia**

Equipos de Toyama Colombia SAS  
Cra. 68 D No 25 B 85 Of. 618  
Edificio Torre Central  
Bogota  
Phone: +57 (1) 703 95 20 /  
+57 (1) 703 95 22  
serviciocliente@toyama.com.co  
www.toyama.com.co

**Costa Rica**

Exim CIA Costa Rica  
Calle 25A, B°. Montelegre  
Zapote  
San José  
Costa Rica  
Phone: (+506) 2221-5654 / (+506) 2221-5659  
eximcostarica@gmail.com

**Croatia**

Husqvarna Austria GmbH  
Industriezeile 36  
4010 Linz  
Phone: (+43) 732 77 01 01-485  
service.gardena@husqvarnagroup.com

**Cyprus**

Pantelis Papadopoulos S.A.  
92 Athinon Avenue  
Athens  
10442 Greece  
Phone: (+30) 21 0519 3100  
info@papadopoulos.com.gr

**Czech Republic**

Gardena  
Service Center Vrbo  
c/o Husqvarna  
Manufacturing CZ s.r.o.  
Jesenická 146  
79326 Vrbo pod Prademem  
Phone: 800 100 425  
servis@gardena.cz

**Denmark**

GARDENA DANMARK  
Løjvej 19, st.  
3500 Varlose  
Tlf.: (+45) 70 26 47 70  
gardenack@husqvarnagroup.com  
www.gardena.com / dk

**Dominican Republic**

BOSQUESA S.R.L.  
Carretera Santiago Licey  
Km. 5 ½  
Esquina Copal II,  
Santiago De Los Caballeros  
51000 Dominican Republic  
Phone: (+1) 809-562-0476  
contacto@bosquesa.com.do

**Egypt**

Universal Agencies Co  
26, Abdel Hamid Lotfy St.  
Giza  
Phone: (+20) 3 761 57 57

**Estonia**

Husqvarna Eesti OÜ  
Valdeku 132  
EE-11216 Tallinn  
info@gardena.ee

**Finland**

Oy Husqvarna Ab  
Juurakotie 5 B 2  
01510 Vantaa  
www.gardena.fi

**France**

Husqvarna France  
9/11 Allée des pierres mayettes  
92635 Gennevilliers Cedex  
France  
http://www.gardena.com/fr  
N° AZUR: 0 810 00 78 23  
(Prix d'un appel local)

**Georgia**

Transporter LLC  
#70, Bakashvili street  
0150 Tbilisi, Georgia  
Number: (+995) 322 14 71 71  
info@transporter.com.ge  
www.transporter.com.ge

**Service Address and Importer to Great Britain**

Husqvarna UK Ltd  
Preston Road  
Aycliffe Industrial Park  
Newton Aycliffe  
County Durham  
DL5 6UP  
Phone: (+44) (0) 344 844 4558  
info.gardena@husqvarna.co.uk

**Greece**

Π.ΠΑΠΑΔΟΠΟΥΛΟΣ ΑΕΒΕ  
Λεωρ. Αθηνών 92  
Αθήνα  
T.K. 104 42  
Ελλάδα  
Tηλ. (+30) 210 5193 100  
info@papadopoulos.com.gr

**Hong Kong**

Tung Tai Company  
151-153 Hoi Bun Road  
Kwun Tong, Kowloon  
Hong Kong  
Phone: (+852) 3583 1662  
admin@tungtaico.com

**Hungary**

Husqvarna Magyarországi Kft.  
Ezred u. 1 – 3  
1044 Budapest  
Phone: (+36) 1 251-4161  
vevoszolgalat.husqvarna@husqvarna.hu

**Iceland**

BYKO ehf.  
Skemmuvegi 2a  
200 Kópavogur  
Phone: (+354) 515 4000  
byko@byko.is

**India**

MHG Verslum ehf  
Vikurhvarf 8  
203 Kópavogur  
Phone: (+354) 544 4656

**Indonesia**

B K RAMAN AND CO  
Plot No. 185, Industrial Area,  
Phase-2, Ram Darbar  
Chandigarh  
160002 India  
Phone: (+91) 98140 06530  
raman@jaganhardware.com

**Iraq**

Alshiemal Alakhdar Company  
Al-Faysalieah, Near Estate Bank  
Mosul  
Phone: (+964) 78 18 16 46 75

**Ireland**

Liffey Distributors Ltd.  
309 NW Business Park, Ballycoolen  
15 Dublin  
Phone: (+353) 1 824 2600  
info@liffeyd.com

**Israel**

HAGARIN LTD.  
2 Nahal Harif St.  
812201 Yavne  
internet@hagarin.co.il  
Phone: (+972) 8-932-0400

**Italy**

Husqvarna Italia S.p.A.  
Centro Direzionale Planum  
Via del Lavoro 2, Scala B  
22036 ERBA (CO)  
Phone: (+39) (0) 31 4147700  
assistenza.italia@it.husqvarna.com

**Japan**

Husqvarna Zenoh Co. Ltd. Japan  
1-9 Minamidai, Kawagoe  
350-1165 Saitama  
Japan  
gardena-jp@husqvarnagroup.com

**Kazakhstan**

ТОО "Ламед"  
Russian  
Адрес: Казахстан, г. Алматы,  
ул. Тажибаявой, 155/1  
Тел.: (+7) (727) 355 64 00 /  
(+7) (700) 355 64 00 lamed@lamed.kz

**Kuwait**

Мекен-жайы: Қазақстан,  
Алматы қ.,  
көш. Тәжібаявой, 155/1  
Тел.: (+7) (727) 355 64 00 /  
(+7) (700) 355 64 00  
lamed@lamed.kz

**Kyrgyzstan**

ООСО Аяк Мэки  
Ав. Молдаяга Гуардия 83  
720014 Bishkek  
Phone: (+996) 312 322115

**Latvia**

Husqvarna Latvija SIA  
Ulbrokas 19A  
LV-1121 Riga  
info@gardena.lv

**Lebanon**

Technomec  
Sifra Highway (Beirut – Tripoli) Center  
622 Mezher Bldg.  
P.O.Box 215  
Jounieh  
Phone: (+961) 9 853527 /  
(+961) 3 855481  
tecnomec@idm.net.lb

**Lithuania**

UAB Husqvarna Lietuva  
Ateities pl. 77C  
LT-52104 Kaunas  
info@gardena.lt

**Luxembourg**

Magasins Jules Neuberg  
39, rue Jacques Stas  
Luxembourg-Gasperich 2549  
Case Postale No. 12  
Luxembourg 2010  
Phone: (+352) 40 14 01  
api@neuberg.lu

**Malaysia**

Glomedic International Sdn Bhd  
Jalan Huang No. 30  
Shah Alam, Selangor  
40150 Malaysia  
Phone: (+60) 3-7734 7997  
alsea@glomedic.com.my

**Malta**

I.V. Portelli & Sons Ltd.  
85, 86, Triq San Pawl  
Rabat - RBT 1240  
Phone: (+356) 2145 4289

**Mauritius**

Espace Maison Liée  
La City Trianon, St Jean  
Quatre Bornes  
Phone: (+230) 460 85 85  
digital@espacemaison.mu

**Mexico**

AFOSA  
Av. Lopez Mateos Sur # 5019  
Col. La Calma 45070  
Zapopan, Jalisco, Mexico  
Phone: (+52) 33 3818-3434  
isolis@afosa.com.mx

**Moldova**

Convel SRL  
Republica Moldova,  
mun. Chisinau,  
sos. Muncesti 284  
Phone: (+373) 22 857 126  
www.convel.md

**Mongolia**

Soyolj Gardening Shop  
Narnii Rd  
Ulaanbaatar  
14230 Mongolia  
Phone: +976 7777 5080  
soyolj@magicnet.mn

**Morocco**

Proekip  
64 Rue de la Participation  
Casablanca-Roches Noires  
20303 Morocco  
Phone: (+212) 661342107  
hicham.hatani@proekip.ma

**Netherlands**

Husqvarna Nederland B.V.  
GARDENA Division  
Postbus 50131  
1305 AC ALMERE  
Phone: (+31) 36 521 00 10  
info@gardena.nl

**Neth. Antilles**

Jonka Enterprises N.V.  
Sta. Rosa Weg 196  
P.O. Box 8200  
Curaçao  
Phone: (+599) 9 767 66 55  
info@jonka.com

**New Zealand**

Husqvarna New Zealand Ltd.  
PO Box 76-437  
Manukau City 2241  
Phone: (+64) (0) 9 9202410  
support.nz@husqvarna.co.nz

**North Macedonia**

Sinpekis d.o.o.  
Ul. Kravarski Pat Bb  
7000 Bitola  
Phone: (+389) 47 20 85 00  
sinpekis@mt.net.mk

**Norway**

Husqvarna Norge AS  
Gardena Division  
Trøskenveien 36  
1708 Sarpsborg  
info@gardena.no

**Northern Cyprus**

Mediterranean Home & Garden  
No 150 Alsancak, Karaoglanoglu  
Caddesi Girne  
Phone: (+90) 392 821 33 80  
info@medgardener.com

**Oman**

General Development Services  
PO 1475, PC - 111  
Seeb  
111 Oman  
Phone: 96824562816  
gdsoman@gdsoman.com

**Paraguay**

Agrofield SRL  
AV. CHOFERES DEL CHACO  
1449 C/25 DE MAYO  
Asuncion  
Phone: (+595) 21 608 656  
consultas@agrofield.com.py

**Peru**

Sierras y Herramientas Forestal SAC  
Av. Las Gaviotas 833, Chorrillos  
Lima  
Phone: (+51) 1 2 52 02 52  
supervisorventas1@siersac.com  
www.siersac.com

**Philippines**

Royal Dragon Traders Inc  
10 Linaw Street, Barangay  
Saint Peter Quezon City  
1114 Philippines  
Phone: (+63) 2 7426893  
aida.fernandez@rdti.com.ph

**Poland**

Gardena Service Center Vrbo  
c/o Husqvarna Manufacturing CZ  
s.r.o. Jesenícká 146  
79326 Vrbo pod Prademem  
Czech Republic  
Phone: (22) 336 78 90  
servis@gardena.pl

**Portugal**

Husqvarna Portugal, SA  
Lagoa - Albaraque  
2635 - 595 Rio de Mouro  
Phone: (+351) 21 922 85 30  
Fax: (+351) 21 922 85 36  
info@gardena.pt

**Romania**

Madex International Srl  
Soseaua Otilii 117 - 123,  
RO 013603 Bucuresti, S1  
Phone: (+40) 21 352 7603  
madex@ines.ro

**Russia / Россия**

ООО «Хускварна  
141400, Московская обл.,  
г. Химки,  
улица Ленинградская,  
владение 39, стр.6  
Бизнес Центр  
«Химки Бизнес Парк»,  
помещение 0B02\_04  
http://www.gardena.ru

**Saudi Arabia**

SACO  
Takhassusi Main Road P.O. Box:  
86387 Riyadh 12863  
40011 Saudi Arabia  
Phone: (966) 11 482 8877  
webmaster@saco-ksa.com  
Al Futtaim Pioneer Trading  
5147 Al Farooq Dist.  
Riyadh 7991  
Phone: (+971) 4 206 6700  
Owais.Khan@alfuttaim.com

**Serbia**

Domel d.o.o.  
Slobodana Đurića 21  
11000 Belgrade  
Phone: (+381) 11 409 57 12  
office@domel.rs  
Singapore  
Hi-Ray PRIVATE LIMITED  
40 Jalan Pemimpin  
#02-08 Tai Ann Building  
Singapore 577185  
Phone: (+65) 6253 2277  
info@hi-ray.com.sg

**Slovak Republic**

Gardena  
Service Center Vrbo  
c/o Husqvarna  
Manufacturing CZ s.r.o.  
Jesenická 146  
79326 Vrbo pod Prademem  
Phone: 0800 154044  
servis@gardena.sk  
Slovenia  
Husqvarna Austria GmbH  
Industriezeile 36  
4010 Linz  
Phone: (+43) 732 77 01 01-485  
service.gardena@husqvarnagroup.com

**South Africa**

Husqvarna South Africa (Pty) Ltd  
Lifestyle Business Park –  
Ground Floor Block A Cnr  
Beyers Naude Drive and Ysterhout  
Road Randpark Ridge, Randburg  
Phone: (+27) 10 015 5750  
service@gardena.co.za

**South Korea**

Kyung Jin Trading Co., Ltd  
8F Haengbok Building, 210,  
Gangnam-Daero 137-891 Seoul  
Phone: (+82) 2-574 6300  
kjh@kjh.co.kr

**Spain**

Husqvarna España S.A.  
Calle de Rivas nº 10  
28052 Madrid  
Phone: (+34) 91 708 05 00  
atencioncliente@gardena.es

**Sri Lanka**

Hunter & Company Ltd.  
130 Front Street  
Colombo  
Phone: 94-11 232 81 71  
hunters@eureka.lk

**Suriname**

Deto Handelmaatschappij N.V.  
Kernkampweg 72-74  
P.O. Box: 12782  
Paramaribo  
Suriname  
Phone: (+597) 43 80 50  
info@deto.sr

**Sweden**

Husqvarna AB /  
GARDENA Sverige  
Drottninggatan 2  
561 82 Huskvarna  
Sverige  
Phone: (+46) (0) 36-14 60 02  
service@gardena.se

**Switzerland / Schweiz**

Husqvarna Schweiz AG  
Consumer Products  
Industriestrasse 10  
5506 Mägerwil  
Phone: (+41) (0) 62 887 37 90  
info@gardena.ch

**Taiwan**

Hong Ying Trading Co., Ltd.  
No. 46 Wu-Kun-Wu Road  
New Taipei City  
Phone: (+886) (02) 2298 1486  
salesgd1@7friends.com.tw

**Tajikistan**

AIERS JV LLC  
39, Ayni Street, 734024  
Dushanbe, Tajikistan

**Thailand**

Spica Co. Ltd  
243/2 Onnuh Rd., Prawat  
Bangkok  
10250 Thailand  
Phone: (+66) (0)2721 7373  
surapong@spica-siam.com

**Tunisia**

Société du matériel agricole et maritime  
Nouveau port de pêche de Sfax Bp 33  
Sfax 3065  
Phone: (+216) 98 419047/  
(+216) 74 497614  
commercial@smamtunisia.com

**Turkiye**

Dost Bahçe  
Yunus Mah. Adli Sk. No:3  
Kartal  
Istanbul  
34873 Türkiye  
Phone: (+90) 216 389 39 39

**Turkmenistan**

I.E. Orazmuhamedov Nurmuhammet  
80 Ataturk, BERKARAR Shopping Center,  
Ground floor, A/77B,  
Ashgabat 744000  
TURKMENISTAN  
Phone: (+993) 12 468859  
Mob: (+993) 62 222887  
info@jayhymat.com /  
bekgiyev@jayhymat.com  
www.jayhymat.com

**UAE**

Al-Futtaim ACE Company  
L.L.C Building, Al Rebat Street  
Festival City, Dubai  
7880 UAE  
Phone: (+971) 4 206 6700  
ace@alfuttaim.ae

**Ukraine / Україна**

AT «Альцест»  
вул Петропавлівська 4  
08130, Київська обл.  
Києво-Святошинський р-н, с.  
Петропавлівська Борщагівка Україна  
Тел.: (+38) 0 800 503 000

**Uruguay**

FELI SA  
Entre Rios 1083  
11800 Montevideo  
Phone: (+598) 22 03 18 44  
info@felisa.com.uy

**Uzbekistan**

AGRIHOUSE MCHJ  
O'zbekiston, 111112  
Toshkent viloyati  
Toshkent tumani  
Hasanboy OFY, THAY yoqasida  
Phone: (+998)-93-5414141 /  
(+998)-71-2096868  
info@agro.house  
www.agro.house

**Vietnam**

Vision Joint Stock Company  
BT1-17, Khu biet thu –  
Khu Doan ngoi gao Nguyen Xuan Khat  
Xuan Dinh, Bac Tu Liem  
Hanoi, Vietnam  
Phone: (+8424)-38462833/34  
quynhnm@visionjsc.com.vn  
Zimbabwe  
Cutting Edge  
159 Citron Rd, Msasa  
Harare  
Phone: (+263) 8677 008685  
sales@cuttingedge.co.zw

14733-20.960.02/0422

© GARDENA Manufacturing GmbH  
D-89079 Ulm  
https://www.gardena.com