

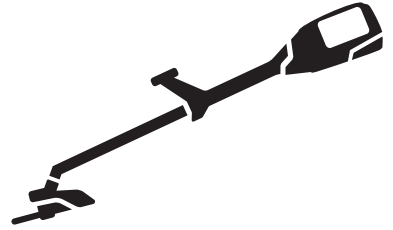

**Husqvarna**<sup>®</sup>

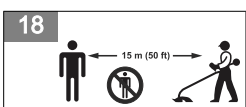

**325iR**

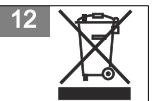
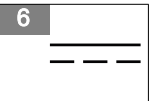
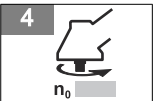
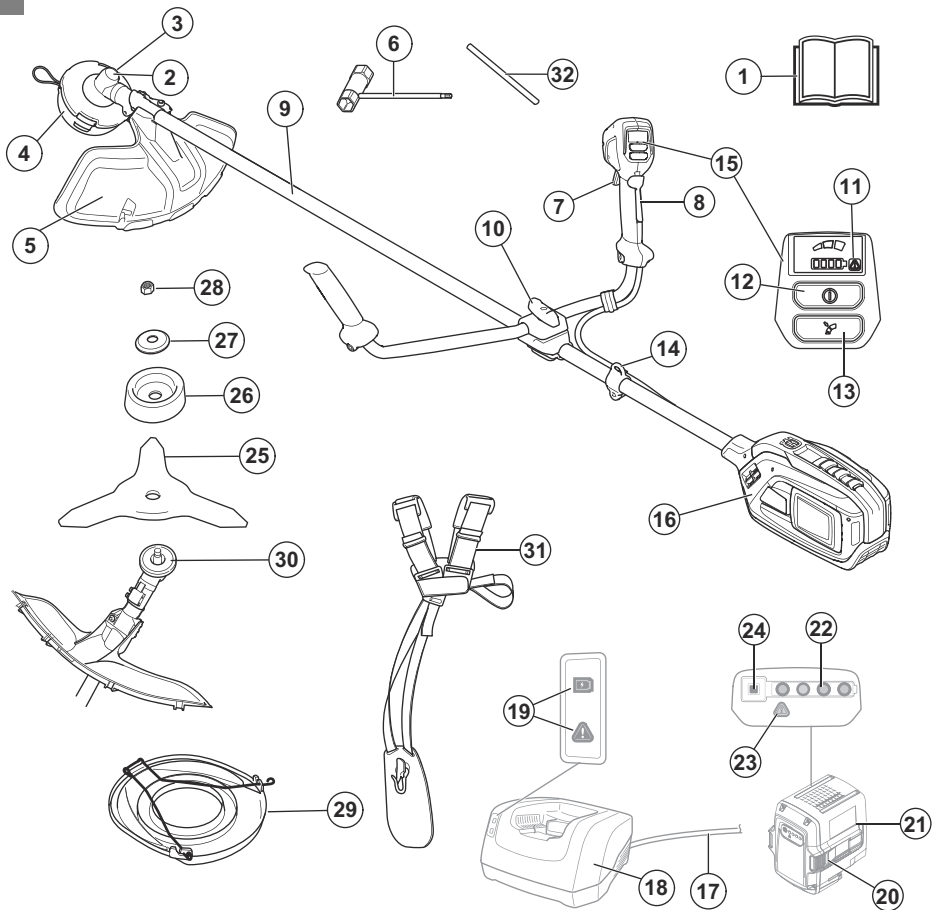

19



20



21



22

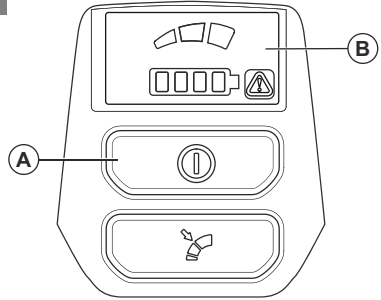

23

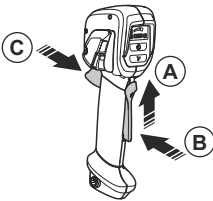

24

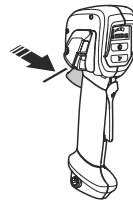

25

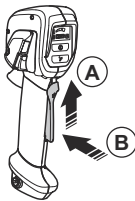

26

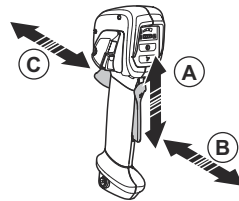

27

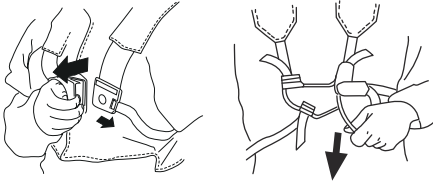

28

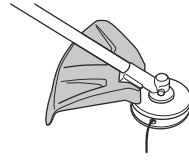

29

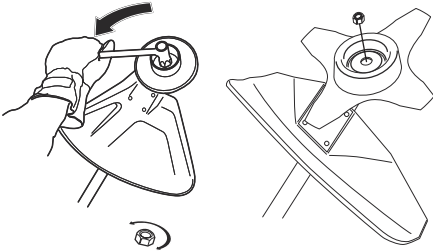

30

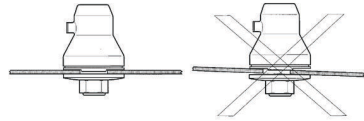

31

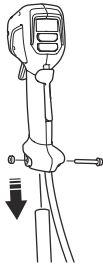

32

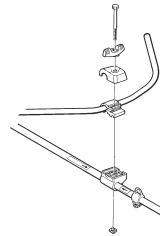

33

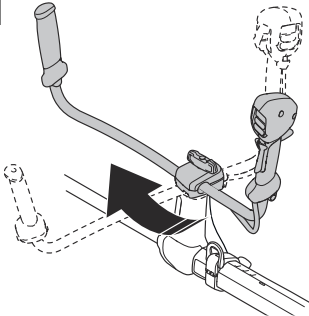

34

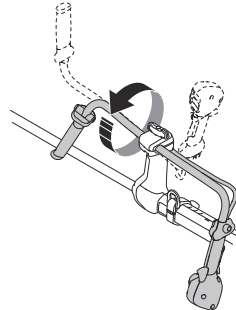

35

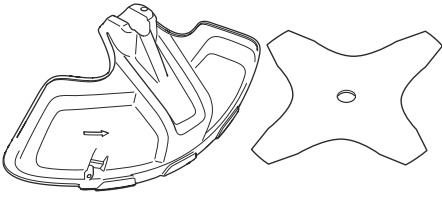

36

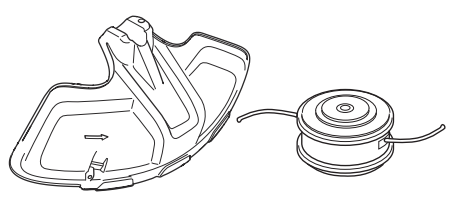

37

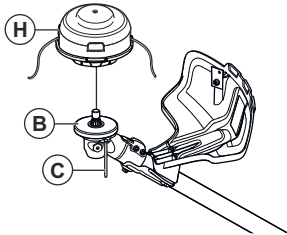

38

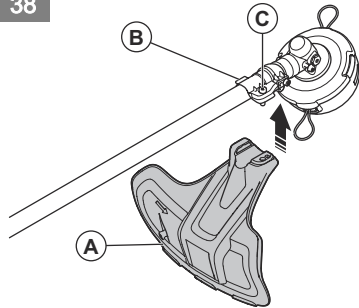

39

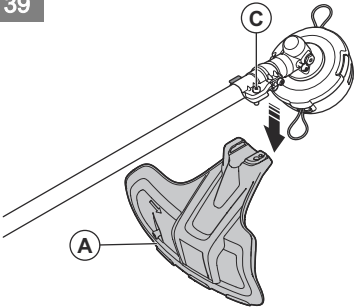

40

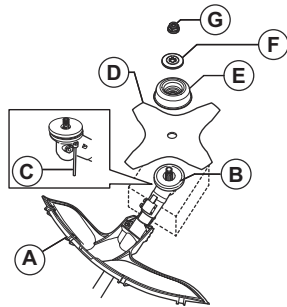

41

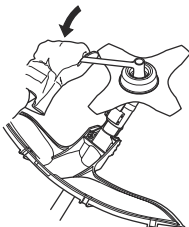

42



43



44

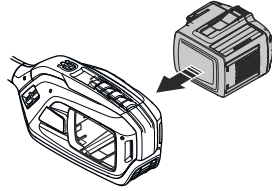

45

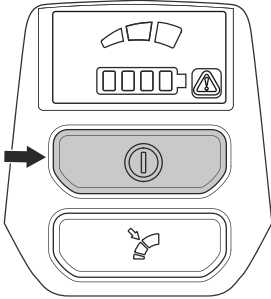

46

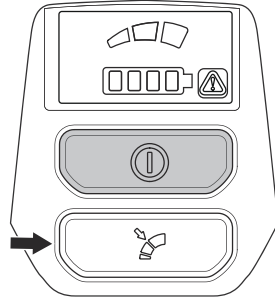

47

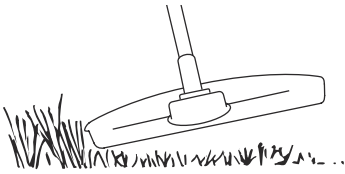

48



49

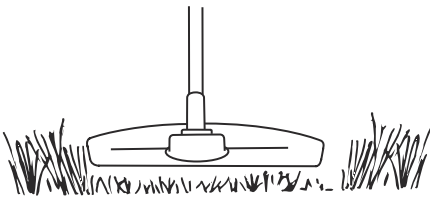

50

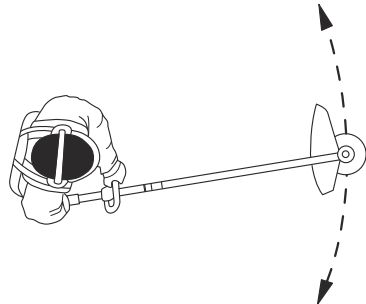

51

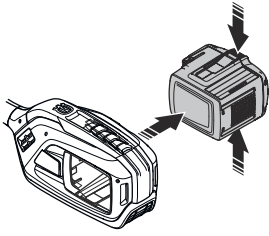

52

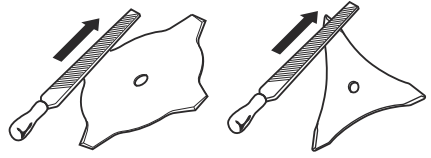

53

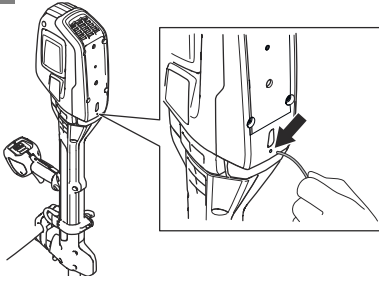

54

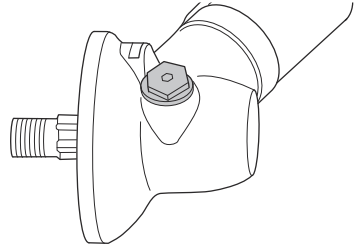

55

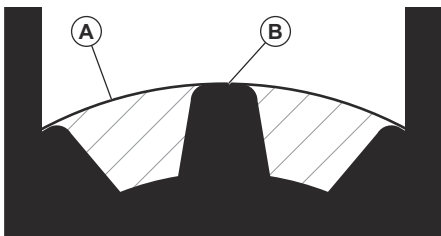

---

# Contents

---

Introduction.....	8	Transportation, storage and disposal.....	21
Safety.....	9	Technical data.....	21
Assembly.....	16	Accessories.....	23
Operation.....	17	Declaration of Conformity.....	24
Maintenance.....	19	Appendix .....	26
Troubleshooting.....	20		

---

## Introduction

---

### Product description

This product is a battery operated grass trimmer/brushcutter with an electrical motor.

Work is constantly in progress to increase your safety and efficiency during operation. Speak to your servicing dealer for more information.

### Intended use

Use the product with a grass blade or a trimmer head to cut different types of vegetation. Do not use the product for other tasks than grass trimming and grass clearing.

### Product overview

(Fig. 1)

1. Operator's manual
2. Bevel gear
3. Hole for locking pin
4. Trimmer head
5. Cutting attachment guard
6. Combination wrench
7. Power trigger
8. Power trigger lockout
9. Shaft
10. Knob
11. Warning indicator (LED)
12. Start/Stop button
13. Speed mode button
14. Suspension point
15. User interface
16. Power unit
17. Charger cable
18. Battery charger
19. Power on and Warning indicator (LED)
20. Battery release buttons
21. Battery
22. State of charge
23. Warning indicator (LED)
24. Battery indicator button
25. Grass blade
26. Support cup

**Note:** National or local regulations can set limit to the operation of the product.

---

Only use the product with accessories that are approved by the manufacturer. Refer to *Accessories on page 23*.

27. Support flange
28. Locknut
29. Transport cover
30. Drive disc
31. Harness

### Symbols on the product

(Fig. 2) **WARNING!** This product can be dangerous! Careless or incorrect use can result in serious or fatal injury to the operator or others. It is extremely important that you read and understand the contents of the operator's manual. Please read the operator's manual carefully and make sure you understand the instructions before the product is used.

(Fig. 3) Use approved hearing protection. Use approved eye protection.

(Fig. 4) Maximum speed or no-load speed.

XXXX /min  
or min<sup>-1</sup> | Revolutions or reciprocations per minute.

(Fig. 5) Rated voltage, V



(Fig. 6)	Direct current.		legislations "Protection of the Environment Operations (Noise Control) Regulation 2017". The guaranteed sound power level of the product is specified in <i>Technical data</i> on page 21.
(Fig. 7)	The product agrees with the applicable EC directives.		
(Fig. 8)	This product conforms to the applicable UK regulations.		The rating plate shows the serial number. <b>yyyy</b> is the production year, <b>ww</b> is the production week and <b>xxxx</b> is the sequential number.
(Fig. 9)	Use approved protective gloves.	<b>yyyywwxxxx</b>	
(Fig. 10)	Use heavy-duty slip-resistant boots.		
(Fig. 11)	Beware of blade thrust.		The operator must ensure that no people or animals come closer than 15 metres. When several operators are working at the same site a safety distance of at least 15 metres must be in effect.
(Fig. 12)	Symbols on the product or its packaging indicate that this product cannot be handled as domestic waste. This product must be deposited at an appropriate recycling facility.	(Fig. 18)	
(Fig. 13)	The attachment can forcibly throw objects that can bounce back. This can result in serious eye injuries if the recommended safety equipment is not used.		
(Fig. 14)	Disconnect battery before maintenance.		
(Fig. 15)	The product has protection against splashing water.		
(Fig. 16)	Keep all parts of your body away from the hot surfaces.		
(Fig. 17)	Noise emission to the environment label as per EU and UK directives and regulations, and New South Wales		

---

**Note:** Other symbols/decals on the product refer to certification requirements for other commercial areas.

---

## Product damage

We are not responsible for damages to our product if:

- the product is incorrectly repaired.
- the product is repaired with parts that are not from the manufacturer or not approved by the manufacturer.
- the product has an accessory that is not from the manufacturer or not approved by the manufacturer.
- the product is not repaired at an approved service center or by an approved authority.

---

## Safety

---

### Safety definitions

Warnings, cautions and notes are used to point out specially important parts of the manual.



**WARNING:** Used if there is a risk of injury or death for the operator or bystanders if the instructions in the manual are not obeyed.



**CAUTION:** Used if there is a risk of damage to the product, other materials or the adjacent area if the instructions in the manual are not obeyed.

**Note:** Used to give more information that is necessary in a given situation.

---

### General machine safety warnings



**WARNING: Read all safety warnings, instructions, illustrations and specifications provided with this machine.** Failure to follow all instructions listed below may result in electric shock, fire and/or serious injury.

- **Save all warnings and instructions for future reference.** The term "machine" in the warnings refers to your mains-operated (corded) machine or battery-operated (cordless) machine.

### Work area safety

- **Keep work area clean and well lit.** Cluttered or dark areas invite accidents.
- **Do not operate machines in explosive atmospheres, such as in the presence of flammable liquids, gases**

or dust. Machines create sparks which may ignite the dust or fumes.

- **Keep children and bystanders away while operating a machine.** Distractions can cause you to lose control.

## Electrical safety

- **Machine plugs must match the outlet. Never modify the plug in any way. Do not use any adapter plugs with earthed (grounded) machines.** Unmodified plugs and matching outlets will reduce risk of electric shock.
- **Avoid body contact with earthed or grounded surfaces, such as pipes, radiators, ranges and refrigerators.** There is an increased risk of electric shock if your body is earthed or grounded.
- **Do not expose machines to rain or wet conditions.** Water entering a machine will increase the risk of electric shock.
- **Do not abuse the cord. Never use the cord for carrying, pulling or unplugging the machine. Keep cord away from heat, oil, sharp edges or moving parts.** Damaged or entangled cords increase the risk of electric shock.
- **When operating a machine outdoors, use an extension cord suitable for outdoor use.** Use of a cord suitable for outdoor use reduces the risk of electric shock.
- **If operating a machine in a damp location is unavoidable, use a residual current device (RCD) protected supply.** Use of a RCD reduces the risk of electric shock.

## Personal safety

- **Stay alert, watch what you are doing and use common sense when operating a machine. Do not use a machine while you are tired or under the influence of drugs, alcohol or medication.** A moment of inattention while operating machines may result in serious personal injury.
- **Use personal protective equipment. Always wear eye protection.** Protective equipment such as dust mask, non-skid safety shoes, hard hat or hearing protection used for appropriate conditions will reduce personal injuries.
- **Prevent unintentional starting. Ensure the switch is in the off-position before connecting to power source and/or battery pack, picking up or carrying the tool.** Carrying machines with your finger on the switch or energising machines that have the switch on invites accidents.
- **Remove any adjusting key or wrench before turning the machine on.** A wrench or a key left attached to a rotating part of the machine may result in personal injury.
- **Do not overreach. Keep proper footing and balance at all times.** This enables better control of the machine in unexpected situations.

- **Dress properly. Do not wear loose clothing or jewellery. Keep your hair and clothing away from moving parts.** Loose clothes, jewellery or long hair can be caught in moving parts.
- **If devices are provided for the connection of dust extraction and collection facilities, ensure these are connected and properly used.** Use of dust collection can reduce dust-related hazards.
- **Do not let familiarity gained from frequent use of tools allow you to become complacent and ignore tool safety principles.** A careless action can cause severe injury within a fraction of a second.

## Machine use and care

- **Do not force the machine. Use the correct machine for your application.** The correct machine will do the job better and safer at the rate for which it was designed.
- **Do not use the machine if the switch does not turn it on and off.** Any machine that cannot be controlled with the switch is dangerous and must be repaired.
- **Disconnect the plug from the power source and/or remove the battery pack, if detachable, from the machine before making any adjustments, changing accessories, or storing machines.** Such preventive safety measures reduce the risk of starting the machine accidentally.
- **Store idle machines out of the reach of children and do not allow persons unfamiliar with the machines or these instructions to operate the machines.** Machines are dangerous in the hands of untrained users.
- **Maintain machines and accessories. Check for misalignment or binding of moving parts, breakage of parts and any other condition that may affect the machines' operation. If damaged, have the machine repaired before use.** Many accidents are caused by poorly maintained machines.
- **Keep cutting tools sharp and clean.** Properly maintained cutting tools with sharp cutting edges are less likely to bind and are easier to control.
- **Use the machine, accessories and tool bits etc. in accordance with these instructions, taking into account the working conditions and the work to be performed.** Use of the machine for operations different from those intended could result in a hazardous situation.
- **Keep handles and grasping surfaces dry, clean and free from oil and grease.** Slippery handles and grasping surfaces do not allow for safe handling and control of the tool in unexpected situations.

## Battery tool use and care

- **Recharge only with the charger specified by the manufacturer.** A charger that is suitable for one type of battery pack may create a risk of fire when used with another battery pack.
- **Use machines only with specifically designated battery packs.** Use of any other battery packs may create a risk of injury and fire.

- **When battery pack is not in use, keep it away from other metal objects, like paper clips, coins, keys, nails, screws or other small metal objects, that can make a connection from one terminal to another.** Shorting the battery terminals together may cause burns or a fire.
- **Under abusive conditions, liquid may be ejected from the battery; avoid contact. If contact accidentally occurs, flush with water. If liquid contacts eyes, additionally seek medical help.** Liquid ejected from the battery may cause irritations or burns.
- **Do not use a battery pack or tool that is damaged or modified.** Damaged or modified batteries may exhibit unpredictable behaviour resulting in fire, explosion or risk of injury.
- **Do not expose a battery pack or tool to fire or excessive temperature.** Exposure to fire or temperature above 130 °C / 265 °F may cause explosion.
- **Follow all charging instructions and do not charge the battery pack or tool outside the temperature range specified in the instructions.** Charging improperly or at temperatures outside the specified range may damage the battery and increase the risk of fire.
- **Wear eye, ear, head and hand protection.** Adequate protective equipment will reduce personal injury by flying debris or accidental contact with the cutting line or blade.
- **While operating the machine, always wear safety footwear. Do not operate the machine when barefoot or wearing open sandals.** This reduces the chance of injury to the feet from contact with a moving cutter, line or blade
- **While operating the machine, always wear long trousers.** Exposed skin increases the likelihood of injury from thrown objects.
- **Keep bystanders away while operating the machine.** Thrown debris can result in serious personal injury.
- **Always use two hands when operating the machine.** Holding the machine with both hands will avoid loss of control.
- **Hold the machine by the insulated gripping surfaces only, because the cutting line or blade may contact hidden wiring.** Cutting line or blades contacting a "live" wire may make exposed metal parts of the machine "live" and could give the operator an electric shock.
- **Always keep proper footing and operate the machine only when standing on the ground.** Slippery or unstable surfaces may cause a loss of balance or control of the machine.
- **Do not operate the machine on excessively steep slopes.** This reduces the risk of loss of control, slipping and falling which may result in personal injury.
- **When working on slopes, always be sure of your footing, always work across the face of slopes, never up or down and exercise extreme caution when changing direction.** This reduces the risk of loss of control, slipping and falling which may result in personal injury.

## Service

- **Have your machine serviced by a qualified repair person using only identical replacement parts.** This will ensure that the safety of the machine is maintained.
- **Never service damaged battery packs.** Service of battery packs should only be performed by the manufacturer or authorized service providers.

## Grass trimmer, brush cutter and brush saw safety warnings

- **Do not use the machine in bad weather conditions, especially when there is a risk of lightning.** This decreases the risk of being struck by lightning.
- **Thoroughly inspect the area for wildlife where the machine is to be used.** Wildlife may be injured by the machine during operation.
- **Thoroughly inspect the area where the machine is to be used and remove all stones, sticks, wires, bones, and other foreign objects.** Thrown objects can cause personal injury.
- **Before using the machine, always visually inspect to see that the cutter or blade and the cutter or blade assembly are not damaged.** Damaged parts increase the risk of injury.
- **Follow instructions for changing accessories.** Improperly tightened blade securing nuts or bolts may either damage the blade or result in it becoming detached.
- **The rated rotational speed of the cutter must be at least equal to the maximum rotational speed marked on the machine.** Cutters running faster than their rated rotational speed can break and fly apart.
- **Keep all parts of the body away from the cutter, line or blade when the machine is operating. Before you start the machine, make sure the cutter, line or blade is not contacting anything.** A moment of inattention while operating the machine may result in injury to yourself or others.
- **Do not operate the machine above waist height.** This helps prevent unintended cutter or blade contact and enables better control of the machine in unexpected situations.
- **When cutting brush or saplings that are under tension, be alert for spring back.** When the tension in the wood fibres is released, the brush or sapling may strike the operator and/or throw the machine out of control.
- **Use extreme caution when cutting brush and saplings.** The slender material may catch the blade and be whipped toward you or pull you off balance.
- **Maintain control of the machine and do not touch cutters, lines or blades and other hazardous moving parts while they are still in motion.** This reduces the risk of injury from moving parts.

- **When clearing jammed material or servicing the machine, make sure the switch is off and the battery pack is removed.** Unexpected starting of the machine while clearing jammed material or servicing may result in serious personal injury.
- **Carry the machine with the machine switched off and away from your body.** Proper handling of the machine will reduce the likelihood of accidental contact with a moving cutter, line or blade.
- **When transporting or storing the machine, always fit the cover on metal blades.** Proper handling of the machine will reduce the likelihood of accidental contact with the blade.
- **Only use replacement cutters, lines, cutting heads and blades specified by the manufacturer.** Incorrect replacement parts may increase the risk of breakage and injury.
- **When clearing jammed material or servicing the machine, make sure the switch is off and the battery pack is removed.** Unexpected starting of the machine while clearing jammed material or servicing may result in serious personal injury.
- Check that the trimmer head and trimmer guard are not damaged or cracked. Replace the trimmer head or trimmer guard if it has been exposed to impact or are cracked. Always use the recommended guard for the cutting attachment you are using. Refer to *Accessories on page 23*.
- This product is a dangerous tool if you are not careful or if you use the product incorrectly. This product can cause serious injury or death to the operator or others.
- This appliance is not intended for use by persons (including children) with reduced physical, sensory or mental capabilities, or lack of experience and knowledge, unless they have been given supervision or instruction concerning use of the appliance by a person responsible for their safety. Children should be supervised to ensure that they do not play with the appliance.
- Never allow children to use or be in the vicinity of the machine. Since the machine is easy to start, children may be able to start it if they are not kept under full surveillance. This can mean a risk of serious personal injury. Therefore disconnect the battery when the machine is not under close supervision.
- Never allow children or other persons not trained in the use of the product and/or the battery to use or service it.

## Other general safety information

- Deactivate the product before you move to another area. Always remove the battery when passing the product to another person.
- Never put the product down unless you have deactivated it and removed the battery. Do not leave the product unsupervised when it is switched on.
- The cutting tool does not stop immediately after the product is turned off.
- Before using the product and after any impact, check for signs of wear or damage and repair as necessary.
- If anything jams in the cutting attachment while you operate the product, stop and deactivate the product. Make sure that the cutting attachment stops completely. Remove the battery before you clean, inspect or repair the product and/or the cutting equipment.
- Do a check of the product before use. Refer to *Safety devices on the product on page 14* and *Maintenance on page 19*. Do not use a defective product. Do the safety checks, maintenance and service instructions described in this manual.
- Faulty cutting attachment can increase the risk of accidents.
- Check the gear for dirt and cracks. Clean off grass and leaves from the gear using a brush. Gloves should be worn when necessary.
- Always ensure that ventilation openings are kept clear of debris.
- Check that the trimmer head is completely attached to the trimmer.
- All covers, guards and handles must be fitted before starting.
- Check that the product is in perfect working order. Check that all nuts and screws are tight.
- Store the equipment in a lockable area so that it is out of reach of children and unauthorized persons.
- Keep hands and feet away from the cutting area at all times and especially when switching on the motor.
- Keep your hands and feet away from the cutting attachment until it has stopped completely when the product is deactivated.
- Do not remove the cut material, or let other persons remove cut material, while the product is activated or the cutting equipment rotates, as this can result in serious injury.
- Keep in mind that it is you, the operator that is responsible for not exposing people or their property to accidents or hazards.
- Under no circumstances may the design of the product be modified without the permission of the manufacturer. Always use original accessories. Non-authorized modifications and/or accessories can result in serious personal injury or the death of the operator or others. Your warranty may not cover damage or liability caused by the use of non-authorized accessories or replacement parts.
- The only accessories you can operate with this product are the cutting attachments recommended in the Accessories chapter. Refer to *Accessories on page 23*.
- Never use a product that has been modified in any way from its original specification
- Never use a product that is faulty. Carry out the safety checks, maintenance and service instructions described in this manual. Some maintenance and service measures must be carried out by trained

and qualified specialists. See instructions under the Maintenance heading.

- Working in bad weather is tiring and often brings added risk. Due to the added risk, it is not recommended to use the machine in very bad weather, for instance in dense fog, heavy rain, strong winds, intense cold, risk of lightning, etc
- Never work from a ladder, stool or any other raised position that is not fully secured.
- Store Idle Appliances Indoors – When not in use, appliances should be stored indoors
- It is not possible to cover every conceivable situation you can face. Always exercise care and use your common sense. Avoid all situations which you consider to be beyond your capability. If you still feel uncertain about operating procedures after reading these instructions, you should consult an expert before continuing.
- Ensure that no people or animals come closer than 15 meters while you work. When several operators are working in the same area the safety distance should be at least 15 metres. Otherwise there is a risk of serious personal injury. Stop the product immediately if anyone approaches. Never swing the product around without first checking behind you to make sure that no one is within the safety zone.
- Ensure that people, animals or other things can not affect your control of the product or that they do not come in contact with the cutting attachment or loose objects that are thrown out by the cutting attachment. However, do not use the product unless you are able to call for help in the event of an accident.
- Make sure that you can move and stand safely. Check the area around you for possible obstacles (roots, rocks, branches, ditches, etcetera) in case you have to move suddenly. Take great care when you work on sloping ground.
- Walk, never run.
- Inspect the working area. Remove all loose objects, such as stones, broken glass, nails, steel wire, string etc. that could be thrown out or become wrapped around the cutter or cutter guard.
- Watch out for stumps of branches that can be thrown out when you cut. Do not cut too close to the ground where stones and other objects can be thrown out.
- Make sure that no clothes or parts of the body come in contact with the cutting attachment when the product is activated. Keep the product below waist level.
- Watch out for thrown objects. Always wear approved eye protection. Never lean over the cut-ting attachment guard. Stones, rubbish, etc., can be thrown up into the eyes which can cause blindness or serious injury.
- Listen out for warning signals or shouts when you wear hearing protection. Always remove your hearing protection as soon as the product stops.

- If any unwanted vibrations occur, tap out new line to give the line the correct length to stop the vibrations.
- If the product starts vibrating abnormally, stop the product and remove the battery.
- Overexposure to vibration can lead to circulatory damage or nerve damage in persons who have poor circulation. Speak to your physician if you experience symptoms of overexposure to vibration. Such symptoms include numbness, loss of feeling, tingling, pricking, pain, loss of strength, changes in skin color or condition. These symptoms usually show in the fingers, hands or wrists.
- Always hold the product with both hands. Hold the product on the right side of your body.

### Blade thrust causes and related warnings

- **Blade thrust is a sudden sideways, forward or backward motion of the machine, which may occur when the blade jams or catches on an object such as a sapling or a tree stump. It can be violent enough to cause the machine and/or operator to be propelled in any direction, and possibly lose control of the machine.** Blade thrust and its related hazards can be avoided by taking proper precautions as given below.
- **Maintain a firm grip with both hands on the machine and position your arms to resist blade thrust. Position your body to the left side of the machine.** Blade thrust can increase the risk of injury due to the machine moving unexpectedly. Blade thrust can be controlled by the operator if proper precautions are taken.
- **If the blade binds, or when interrupting a cut for any reason, switch the machine off and hold the machine motionless in the material until the blade comes to a complete stop. While the blade is binding, never attempt to remove the machine from the material or pull the machine backward while the blade is in motion, otherwise blade thrust may occur.** Investigate and take corrective actions to eliminate the cause of blade binding.
- **Do not use blunt or damaged blades.** Blunt or damaged blades increase the risk of jamming or catching on an object, resulting in blade thrust.
- **Always maintain good visibility of the material being cut.** Blade thrust is more likely to occur in areas where it is difficult to see the material being cut.
- **If you are approached by another person while operating the machine, switch the machine off.** There is an increased risk of injury to other persons being struck by the moving blade in the event of blade thrust.

### Personal protective equipment



**WARNING:** Read the warning instructions that follow before you use the product.

- Always use approved personal protective equipment when you use the product. Personal protective equipment cannot fully prevent injury but it decreases the degree of injury if an accident does occur. Let your dealer help you select the correct equipment.
- Use a helmet if the trees in the work area have a height of more than 2 m/6.5 ft.
- Use approved hearing protection.
- Always use approved protective goggles that comply with ANSI Z87.1 standard in the USA or EN 166 in EU countries. Use visor for face protection. Visor is not enough to protect the eyes.

(Fig. 19)

- Use gloves when it is necessary, for example when you attach, examine or clean the cutting equipment.
- Use protective boots with steel toe-cap and non-slip soles.
- Use clothing made of a strong fabric. Always use heavy, long pants and long sleeves. Do not use loose clothing that can catch on twigs and branches. Do not use jewelry, short pants or sandals. Do not go with bare feet. Put your hair up safely above shoulder level.  
(Fig. 20)
- Keep first aid equipment near.

(Fig. 21)

## Safety devices on the product



**WARNING:** Read the warning instructions that follow before you use the product.

In this section the product's safety features, its purpose and how checks and maintenance should be carried out to ensure that it operates correctly. See instructions under the heading *Product overview on page 8* to find where these parts are located on your product.

The life span of the product can be reduced and the risk of accidents can increase if product maintenance is not carried out correctly and if service and/or repairs are not carried out professionally. If you need further information please contact your nearest servicing dealer.



**WARNING:** Never use a product with damaged safety components. The product's safety equipment must be inspected and maintained as described in this section. If your product fails any of these checks, contact your service agent to get it repaired.



**CAUTION:** All servicing and repair work on the machine requires special training. This is especially true of the machine's safety equipment. If your machine fails any of the checks described below you

must contact your service agent. When you buy any of our products we guarantee the availability of professional repairs and service. If the retailer who sells your machine is not a servicing dealer, ask him for the address of your nearest service agent.

## To do a check of the user interface

1. Press and hold the start/stop button (A).
  - a) The product is on when the display (B) comes on. (Fig. 22)
  - b) The product is off when the display goes off.
2. If the warning indicator on the display is on or flashes, refer to *Troubleshooting on page 20*.

## To do a check of the power trigger lockout

The power trigger lockout prevents accidental operation. When you push the power trigger lockout forward (A) and then press the power trigger lockout against the handle (B), the power trigger (C) is released. When you release the handle, the power trigger and the power trigger lockout move back to their initial positions. This movement is operated by independent springs.  
(Fig. 23)

1. Make sure that the power trigger is locked when the lock is in its initial position. (Fig. 24)
2. Press the power trigger and make sure that it goes back to its initial position when you release it. (Fig. 25)
3. Make sure that the power trigger and the lock moves freely and that the return spring operates correctly. (Fig. 26)
4. Start the product, refer to *To start the product on page 18*.
5. Apply full speed.
6. Release the power trigger and make sure that the cutting attachment stops fully.

## Quick-release function of the harness



**WARNING:** Do not use the harness with a quick-release function that does not operate correctly. Make sure that the harness quick-release function operates correctly when you adjust the product.

- The harness quick-release function is at the front of the product.

(Fig. 27)

- The harness straps must always stay at the correct position.
- In an emergency, the harness quick-release function helps you to safely release from the product.

## To do a check of the cutting attachment guard



**WARNING:** Do not use a cutting attachment without an approved and correctly attached cutting attachment guard. Always use the recommended cutting attachment guard for the cutting attachment that you use, see *Accessories on page 23*. If an incorrect or faulty cutting attachment guard is attached this can cause serious personal injury.

The cutting attachment guard stops objects that ejects in the direction of the operator. It also prevents injuries that occur if you touch the cutting attachment.

1. Stop the product and remove the battery.
2. Do a visual check for damages, for example cracks. (Fig. 28)
3. Replace the cutting attachment guard if it is damaged.

## To attach and remove the locknut



**WARNING:** Stop the product and remove the battery, use protective gloves and be careful around the sharp edges of the cutting attachment.

A locknut is used to attach some types of cutting attachments. The locknut has a left thread. (Fig. 29)

- To attach, tighten the locknut in the opposite direction to the direction of rotation of the cutting attachment.
- To remove the locknut, undo the lock nut in the same direction as the cutting attachment rotates.
- To loose and tighten the locknut, use a socket spanner with a long shaft. The arrow in the picture shows the area where you should operate the socket spanner.

**Note:** Make sure that you can not turn the locknut by hand. Replace the nut if the nylon lining does not have a resistance of a minimum of 1.5 Nm. The nut should be replaced after it has been put on approximately 10 times.

## Cutting attachment



**WARNING:** Remove the battery and make sure that the cutting attachment stops completely before you work on any part of the cutting attachment.



**WARNING:** Use correct cutting attachment. Only use the cutting attachment with the guards we recommend, refer

to *Accessories on page 23*. Make sure that the cutting attachment is sharpened correctly. A cutting attachment that is not sharpened correctly increases the risk of blade thrust.



**WARNING:** A coasting blade can cause injury while it continues to spin after the switch has been released. Need to maintain proper control until the blade has completely stopped rotating.

(Fig. 30)

Wear protective gloves when the cutting attachment is handled.

- Use the blades and grass knives to cut coarse grass.
- Use the trimmer head to trim grass.
- Check the cutting attachment for damage or cracks. Replace a damaged cutting attachment.

## Trimmer head

- Always use the correct trimmer head, cutting attachments and always use the recommended trimmer line. Refer to *Accessories on page 23* and the assembly in the end of the Manual.
- Make sure that the cutter on the trimmer guard is not damaged.
- Make sure that the trimmer line is wound tightly and equally around the drum to prevent unusual vibrations from the product. Different cord lengths can result in vibrations that are not necessary. Tap the trimmer head to get correct length on the cord.

To increase the life of the cord it can be soaked in water for 2 days or more before assembly. This will make the cord more resistant.

## Grass blade

- Use correctly sharpened blades. An incorrectly sharpened or damaged blade increases the risk of injury.
- To sharpen and set the blade correctly, refer to the instructions that come with the blade.

## Safety instructions for assembly



**WARNING:** Read, understand and obey these instructions carefully before you use the product.

- Remove the battery from the product before you assemble the product.
- Use approved protective gloves.
- When you use a grass blade, make sure that the correct blade guard and the harness are attached to the product.

- A damaged or incorrect guard can cause injury. Do not use a cutting attachment that does not have an approved guard attached.
- The drive disc and support flange must engage correctly in the centre hole of the cutting attachment. A cutting attachment that is attached incorrectly can cause injury or death.
- To operate the product safely and prevent injury to the operator or other persons, the product must always be attached correctly to the harness.

- Do not clean the battery or the battery charger with water. Strong detergent can cause damage to the plastic.
- If you do not do maintenance, it decreases the life cycle of the product and increases the risk of accidents.
- Special training is necessary for all servicing and repair work, especially for the safety devices on the product. If not all checks in this operator's manual are approved after you have done maintenance, turn to your servicing dealer. We guarantee that there are professional repairs and servicing available for your product.
- Keep the teeth of the blade correctly sharpened. Obey our recommendations. Also refer to the instructions on the blade package.
- Only use original spare parts.
- Always use heavy duty gloves when you repair the cutting attachment. The blades are very sharp and can easily cause injuries.

## Safety instructions for maintenance



**WARNING:** Read the warning instructions that follow before you do maintenance on the product.

- Remove the battery before you do maintenance, other checks or assemble the product.
- The operator must only do the maintenance and servicing shown in this operator's manual. Turn to your servicing dealer for maintenance and servicing of a larger extension.

## Assembly

### To assemble the handlebar

1. Remove the screw behind the throttle handle. (Fig. 31)
2. Move the throttle handle to the right side of the handlebar.
3. Align the hole behind the throttle handle with the hole in the handlebar.
4. Put the screw go through the holes. Tighten the screw.
5. Attach the handlebar between the arrows on the shaft. Tighten the screw. (Fig. 32)



**WARNING:** Always use the cutting attachment guard that is recommended for the cutting attachment. See *Accessories on page 23*.



**WARNING:** An incorrectly attached cutting attachment can result in injury or death.

### To put the handlebar in transport position

1. Loosen the knob.
2. Turn the handlebar until it is parallel to the shaft. (Fig. 33)
3. Turn the handlebar around the shaft until the handlebar clamp locks into transport position. (Fig. 34)
4. Tighten the knob.

### Cutting equipment and guards

The product uses the same cutting attachment guard for the grass blade and the trimmer head.

- Cutting attachment guard and grass blade. (Fig. 35)
- Cutting attachment guard and trimmer head. (Fig. 36)

### Assembly of the trimmer head, the cutting attachment guard and the grass blade

#### To attach the trimmer head T35

1. Put the drive disc (B) on the output shaft.
2. Turn the output shaft to align one of the holes in the drive disc with the related hole in the gear housing.
3. Put the locking pin (C) in the hole to lock the shaft.
4. Turn the trimmer head (H) counterclockwise to attach. (Fig. 37)



**WARNING:** Stop the product and remove the battery. Use protective gloves.



## To remove the trimmer head T35

1. Put the locking pin (C) in the hole to lock the shaft.
2. Turn the trimmer head (H) clockwise to remove it.
3. Remove the drive disc (B) from the output shaft. (Fig. 37)

## To attach the cutting attachment guard

1. Attach the cutting attachment guard (A) to the hook on the plate holder (B). (Fig. 38)
2. Install the cutting attachment guard on the shaft and tighten it with the bolt (C).

## To remove the cutting attachment guard

- Loosen the bolt (C) and remove the cutting attachment guard (A) from the shaft. (Fig. 39)

## To attach the grass blade

1. Put the gear of the product on a flat surface to make sure that the blade is assembled correctly.
2. Turn the output shaft to align one of the holes in the drive disc (B) with the related hole in the gear housing.
3. Put the locking pin (C) in the hole to lock the shaft.
4. Put the grass blade (D), the support cup (E) and the support flange (F) on the output shaft. (Fig. 40)
5. Make sure that the drive disc and support flange engages correctly in the center hole of the grass blade. (Fig. 30)
6. Attach the nut (G).
7. Tighten the nut with the socket wrench. Hold the shaft of the socket wrench near the blade guard. Tighten in the opposite direction to how the cutting attachment rotates. Tighten it to a torque of 35-50 Nm. (Fig. 41)

## To remove the grass blade

1. Put the gear of the product on a flat surface to make sure that the blade is removed correctly.
2. Put the locking pin (C) into the hole on the shaft to lock the shaft.
3. Remove the nut (G).
4. Remove the support flange (F), the support cup (E) and the grass blade (D) from the output shaft. (Fig. 40)

## To adjust the harness



**WARNING:** Always attach this product to the harness correctly. If not, you cannot control the product safely and this can result in injury to you or others. Do not use a harness with a damaged quick release.



**WARNING:** Use the harness quick release function if you must release from the product and the harness in an emergency situation.

1. Put on the harness.
2. Adjust the harness for the best work position.
3. Adjust the side straps until the weight is equally applied across your shoulders. (Fig. 42)
4. Adjust the harness until the cutting attachment is parallel to the ground. (Fig. 43)
5. If the operation is to cut grass, let the cutting attachment stay lightly on the ground. Adjust the suspension point to balance the product correctly.

# Operation

## Introduction



**WARNING:** Read and understand the safety chapter before you use the product.

## To connect the battery to the product



**WARNING:** Only use Husqvarna original batteries with the product.

1. Make sure that the battery is fully charged.
2. Push the battery into the battery holder of the product. The battery locks into position when you hear a click. (Fig. 44)



**CAUTION:** If the battery does not move easily into the battery holder, the battery is not installed correctly. This can cause damage to the product.

3. Make sure that the battery is installed correctly.

## To do before you operate the product

- Examine the work area to make sure that you know the type of terrain. Examine the slope of the ground and if there are obstacles as stones, branches or ditches.
- Do an overhaul of the product.
- Do the safety inspections, maintenance and service that are given in this manual.
- If blade is used, make sure that the locknut is tightened correctly.

- Make sure that all covers and the cutting attachment guard are correctly attached and are not damaged. Replace damaged parts.

## Work position

- Hold the product with 2 hands.
- Hold the product on the right side of your body.
- Keep the cutting attachment below waist level.
- Always keep the product attached to the harness.
- Keep body parts away from the hot surfaces.
- Keep body parts away from the cutting attachment.

## To apply the load equally on the shoulders

1. Adjust the tension of the side straps to apply the weight equally on the shoulders.
2. Adjust the harness for the best work position. An adjusted harness and product makes operation easier.

## To start the product

1. Push and hold the start button until the green LED comes on. (Fig. 45)
2. Use the power trigger to control the speed.

## To limit the maximum speed with the mode button

The product has a mode button. With the the mode button the operator can limit the maximum speed. The mode button has 3 speed levels. A lower level increases the time of operation for the product. Use level 1 and level 2 if the operation does not require full speed/full power. If the operation condition requires full speed/full power, use level 3. Do not use a higher level than necessary for the operation.

1. Push the mode button to set a limit to the maximum speed. The white LEDs comes on to show that the function is on. (Fig. 46)
2. Push the mode button again to choose the next speed level.

## Automatic shutdown function

The product is equipped with a shutdown function that deactivates the product if it is not used.

## To clear grass with a grass blade

1. Grass blades and grass cutters must not be used on woody stems.
2. A grass blade is used for all types of tall or coarse grass.
3. The grass is cut down with a sideways, swinging movement, where the movement from right-to-left is the clearing stoke and the movement from left-to-right is the return stoke. Let the left-hand side of the blade (between 8 and 12 o'clock) do the cutting.

4. If the blade is angled to the left when clearing grass, the grass will collect in a line, which makes it easier to collect, e.g. by raking.
5. Try to work rhythmically. Stand firmly with your feet apart. Move forward after the return stoke and stand firmly again.
6. Let the support cup rest lightly against the ground. It is used to protect the blade from hitting the ground.
7. Reduce the risk of material wrapping around the blade by always work at full speed and avoid the previously cut material during the return stoke.
8. Stop the motor, unclip the harness and place the machine on the ground before you start to collect the cut material.

## Grass trimming with a trimmer head

### To trim the grass

1. Hold the trimmer head immediately above the ground at an angle. (Fig. 47) Do not push the grass trimmer line into the grass.
2. Use 80 % speed when you cut grass near objects. (Fig. 48)

### To cut the grass

1. Make sure that the grass trimmer line is parallel to the ground when you cut. (Fig. 49)
2. Do not push the trimmer head to the ground. The ground and the product can be damaged.
3. Do not let the trimmer head touch the ground continuously, it can cause damage to the trimmer head.
4. Use full speed when you move the product from side to side to cut grass. (Fig. 50) Make sure that the grass trimmer line is parallel to the ground.

### To sweep the grass

The airflow from the rotating trimmer cord can be used to remove cut grass from an area.

1. Hold the trimmer head and its cord parallel to the ground and above the ground.
2. Apply full speed.
3. Move the trimmer head from side to side and sweep the grass.



**WARNING:** Clean the trimmer head cover each time you assemble new trimmer cord to prevent unbalance and vibrations in the handles. Also do a check of the other parts of the trimmer head and clean it if necessary.

## To stop the product

1. Release the power trigger or the power trigger lockout.

2. Push the stop button. (Fig. 45)

3. Push the release buttons on the battery and pull the battery out. (Fig. 51)

---

## Maintenance

---

### Introduction



**WARNING:** Before you do any maintenance work you must read and understand the safety chapter.

### Maintenance schedule



**WARNING:** Remove the battery before you do maintenance.

The following is a list of the maintenance steps that you must do on the product.

Maintenance	Daily	Weekly	Monthly
Clean the external parts of the product with a dry cloth. Do not use water.	X		
Examine that the start and stop button works correctly and is not damaged.	X		
Make sure that the power trigger and the power trigger lockout function correctly from a safety point of view.	X		
Make sure that all controls work and are not damaged.	X		
Keep the handles dry, clean and free from oil and grease.	X		
Make sure that the cutting attachment is not damaged. Replace the cutting attachment if it is damaged.	X		
Make sure that the cutting attachment guard or knife is not damaged. Replace the cutting attachment guard or knife if it is damaged.	X		
Make sure that the screws and nuts are tight.	X		
Make sure that the battery release buttons on the battery works and locks the battery in the product.	X		
Examine that the battery charger is not damaged and function correctly.	X		
Make sure that the battery is not damaged.	X		
Make sure that the suspension point is not damaged.	X		
Make sure that the handle and the handlebar is not damaged and attached correctly.	X		
Make sure that the blade is correctly centered, is sharp, and not damaged. An off-center blade will cause vibration that could result in damage to the product.	X		
Make sure that the locknut of the cutting equipment is tightened correctly.	X		
Make sure that the transport cover for the blade is not damaged and that the transport cover can be attached correctly.	X		
Examine all couplings and connections. Make sure they are not damaged and free from dirt.		X	
Make sure that the bevel gear is filled correctly with grease, see <i>To lubricate the bevel gear on page 20</i> . If not, use Husqvarna bevel gear grease.		X	
Make sure that the air intake of the motor is not dirty. Clean the air intake with compressed air.		X	

Maintenance	Daily	Weekly	Monthly
Do a check of the connections between the battery and the product. Do a check of the connection between the battery and the battery charger.			X
Make sure that the safety release on the harness is not damaged and operates correctly.			X

## To clean the product, the battery and the battery charger

1. Clean the product with a dry cloth after use.
2. Clean the battery and battery charger with a dry cloth. Keep the battery guide tracks clean.
3. Make sure that the terminals on the battery and the battery charger are clean before the battery is put in the battery charger or the product.

## To sharpen the grass knife and grass blade



**WARNING:** Stop the product and remove the battery. Use protective gloves.

- To sharpen the grass knife or grass blade correctly, refer to the instructions that come with the cutting attachment.
- Sharpen all edges equally to keep the balance.
- Use a single-cut flat file. (Fig. 52)



**WARNING:** Always discard a blade that is damaged. Do not try to make a bent or twisted blade straight and use it again.

## To do a check of the trimmer line

Only use the recommended trimmer line. See the illustration on the last pages of the manual.

1. Put the cord into the hole on the cover of the product to make sure it follows the recommendation. (Fig. 53)

## To lubricate the bevel gear

1. Remove the cutting equipment.
2. Put the product with the grease plug at its highest position.
3. Remove the grease plug. (Fig. 54)
4. Look into the grease plug hole and turn the drive shaft. The grease level (A) must be in level with the top of the gear cogs (B). (Fig. 55)
5. If the grease level is too low fill the bevel gear with Husqvarna bevel gear grease. Fill slowly and turn the drive shaft as you apply the bevel gear grease, stop at the correct level (B).



**CAUTION:** An incorrect quantity of grease can cause damage to the bevel gear.

6. Install the grease plug.

# Troubleshooting

## User interface

Problem	Possible faults	Possible action
Battery LED indicator flashes orange	Low battery voltage.	Charge the battery.
Error LED flashes red	Overload.	The cutting attachment is jammed. Stop the product. Remove the battery. Clean the cutting attachment from unwanted materials.
	Temperature deviation.	Let the product cool down.
	The power trigger and the activate button are pressed at the same time.	Release the power trigger and the product is active.
The product does not start	Dirt in the battery connectors.	Clean the battery connectors with compressed air or a soft brush.

Problem	Possible faults	Possible action
Error LED is lit with red light	The product needs servicing.	Contact your servicing agent.

---

## Transportation, storage and disposal

---

### Transportation and storage

- The supplied Li-ion batteries obey the Dangerous Goods Legislation requirements.
  - Obey the special requirement on package and labels for commercial transportation, including by third parties and forwarding agents.
  - Speak to a person with special training in dangerous material before you send the product. Obey all applicable national regulations.
  - Use tape on open contacts when you put the battery in a package. Put the battery in the package tightly to prevent movement.
  - Remove the battery for storage or transportation.
  - Put the battery and the battery charger in a space that is dry and free from moisture and frost.
  - Do not keep the battery in an area where static electricity can occur. Do not keep the battery in a metal box.
  - Put the battery in storage where the temperature is between 5°C/41°F and 25°C/77°F and away from open sunlight.
  - Put the battery charger in storage where the temperature is between 5 °C/41 °F and 45°C/113°F and away from open sunlight.
  - Use the battery charger only when the surrounding temperature is between 5°C/41°F and 40°C/104°F.
- Charge the battery 30% to 50% before you put it in storage for long periods.
  - Put the battery charger in storage in a space that is closed and dry.
  - Keep the battery away from the battery charger during storage. Do not let children and other not approved persons to touch the equipment. Keep the equipment in a space that you can lock.
  - Clean the product and do a full servicing before you put the product in storage for a long time.
  - Use the transportation guard on the product to prevent injuries or damage on the product during transportation and storage.
  - Attach the product safely during transportation.

### Disposal of the battery, battery charger and product

Symbols on the product or the package of the product means that the product is not domestic waste. Recycle it at a recycling station for electrical and electronic equipment. This helps to prevent damage to the environment and to persons.

Get in touch with your local authorities, domestic waste service or your dealer for more information about how to recycle your product.

---

## Technical data

---

### Technical data

	<b>325iR</b>
<b>Motor</b>	
Motor type	Husqvarna e-torq BLDC
Speed of output shaft. Trimmer head/blade, 1/min	5800
Cutting width, mm	420
<b>Weight</b>	
Weight without battery, harness and cutting attachment, kg	3.5

	<b>325iR</b>
<b>Noise emissions</b> <sup>1</sup>	
Sound power level, measured dB (A)	93
Sound power level, guaranteed L <sub>WA</sub> dB (A)	96
<b>Noise levels</b> <sup>2</sup>	
Sound pressure level at the operator's ear, measured according to IEC 62841-1:	
Equipped with trimmer head (original) dB (A)	83
<b>Vibration levels</b> <sup>3</sup>	
Vibration levels at handles, measured according to IEC 62841-1, m/s <sup>2</sup>	
Equipped with trimmer head (original), left/right, m/s <sup>2</sup>	2.4/1.7
Equipped with grass blade (original), left/right, m/s <sup>2</sup>	2.1/1.5
<b>Note:</b> For comparison of vibrations levels, battery and combustion products use the vibration calculator. <a href="https://www.husqvarna.com/uk/services-solutions/vibration-calculator/">https://www.husqvarna.com/uk/services-solutions/vibration-calculator/</a>	

## Approved batteries

Battery	BLi 200	40-B220X
Type	Lithium-ion	Lithium-ion
Battery capacity, Ah	5.2	6
Nominal voltage, V	36	36
Weight, kg (lb)	1.3 (2.9)	1.4 (3.1)

## Approved battery chargers

Battery charger	QC330
Input voltage, V	100-240
Frequency, Hz	50-60
Power, W	330

<sup>1</sup> Noise emissions in the environment measured as sound power (LWA) in conformity with EC directive 2000/14/EC. Reported sound power level for the machine has been measured with the original cutting attachment that gives the highest level. The difference between guaranteed and measured sound power is that the guaranteed sound power also includes dispersion in the measurement result and the variations between different machines of the same model according to Directive 2000/14/EC.

<sup>2</sup> Reported data for sound pressure level for the machine has a typical statistical dispersion (standard deviation) of 3 dB (A).

<sup>3</sup> Reported data for vibration level has a typical statistical dispersion (standard deviation) of 1.5 m/s<sup>2</sup>.

---

## Accessories

---

### Accessories

Approved accessories	Accessory type	Cutting attachment guard, art. no.
Centre hole in blades/knives, Ø 25.4 mm		
Output shaft thread M10		
Grass blade/grass knife	Multi 255-3 (Ø 255, 3 teeth)	536 17 43-01
	Grass 255-4 (Ø 255, 4 teeth)	536 17 43-01
Trimmer head	T35, T35x (Ø 2.4 -2.7 mm Whisper twist trimmer line)	536 17 43-01
Support cup	Fixed	

---

# Declaration of Conformity

---

## EU Declaration of conformity

We, **Husqvarna AB**, SE-561 82 Huskvarna, Sweden, tel: +46-36-146500, declare on our sole responsibility that the product:

<b>Description</b>	Battery-operated brushcutter / grass trimmer
<b>Brand</b>	Husqvarna
<b>Type / Model</b>	325iR
<b>Identification</b>	Serial numbers dating from 2023 and onwards

complies fully with the following EU directives and regulations:

<b>Directive/Regulation</b>	<b>Description</b>
2006/42/EC	"relating to machinery"
2014/30/EMC	"relating to electromagnetic compatibility"
2011/65/EU	"relating to restriction of hazardous substances"
2000/14/EC	"relating to outdoor noise"

and that the following standards and/or technical specifications are applied: EN 62841-1:2015/AC:2015, EN 62841-4-4 (IEC 62841-4-4:2020), EN 61000-6-1:2007 (Immunity), EN 61000-6-3:2007/A1:2011/AC:2012 (Emission).



RISE SMP Svensk Maskinprovning AB, Box 4053, SE-904 03 Umeå, Sweden has performed a voluntary type examination according to annex IX of 2006/42/EC. Certificate No: SEC/23/2580.

Notified body: 0404, RISE SMP Svensk Maskinprovning AB, Box 4053, SE-904 03 Umeå, Sweden has also verified agreement with appendix with VI of the council's directive 2000/14/EC.

For information relating to noise emissions, refer to *Technical data on page 21*.

Huskvarna, 2022-12-01

Two handwritten signatures in black ink. The first signature is 'Stefan Holmberg' and the second is a more stylized signature, likely of the R&amp;D Director mentioned in the text below.

Stefan Holmberg, R&D Director, Technology Management, Husqvarna AB

Responsible for technical documentation



# UK Declaration of conformity

We, **Husqvarna AB**, SE-561 82 Huskvarna, Sweden, tel: +46-36-146500, declare on our sole responsibility that the product:

<b>Description</b>	Battery-operated brushcutter / grass trimmer
<b>Brand</b>	Husqvarna
<b>Type / Model</b>	325iR
<b>Identification</b>	Serial numbers dating from 2023 and onwards

complies fully with the following UK regulations:

<b>Regulations</b>
The Supply of Machinery (Safety) Regulations 2008
Electromagnetic Compatibility Regulations 2016
The Restriction of the Use of Certain Hazardous Substances in Electrical and Electronic Equipment Regulations 2012
The Noise Emission in the Environment by Equipment for use Outdoors Regulations 2001

and that the following standards and/or technical specifications are applied: EN 62841-1:2015/AC:2015, EN 62841-4-4 (IEC 62841-4-4:2020), EN 61000-6-1:2007 (Immunity), EN 61000-6-3:2007/A1:2011/AC:2012 (Emission).

UK Importer:  
Husqvarna UK Ltd  
Preston Road, Co. Durham  
DL5 6UP

Approved body: 0888, HORIBA MIRA Certification Ltd., Watling Street, Nuneaton, Warwickshire, CV10 0TU, UK has certified conformity with the Outdoor Noise Regulations of 2001, conformity assessment procedure: Schedule 9.

For information relating to noise emissions, refer to *Technical data on page 21*.

Husqvarna, 2022-12-01

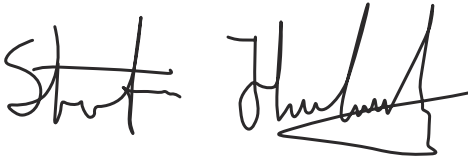

Stefan Holmberg, R&D Director, Technology Management, Husqvarna AB

Responsible for technical documentation

**UK  
CA**

T35, T35x

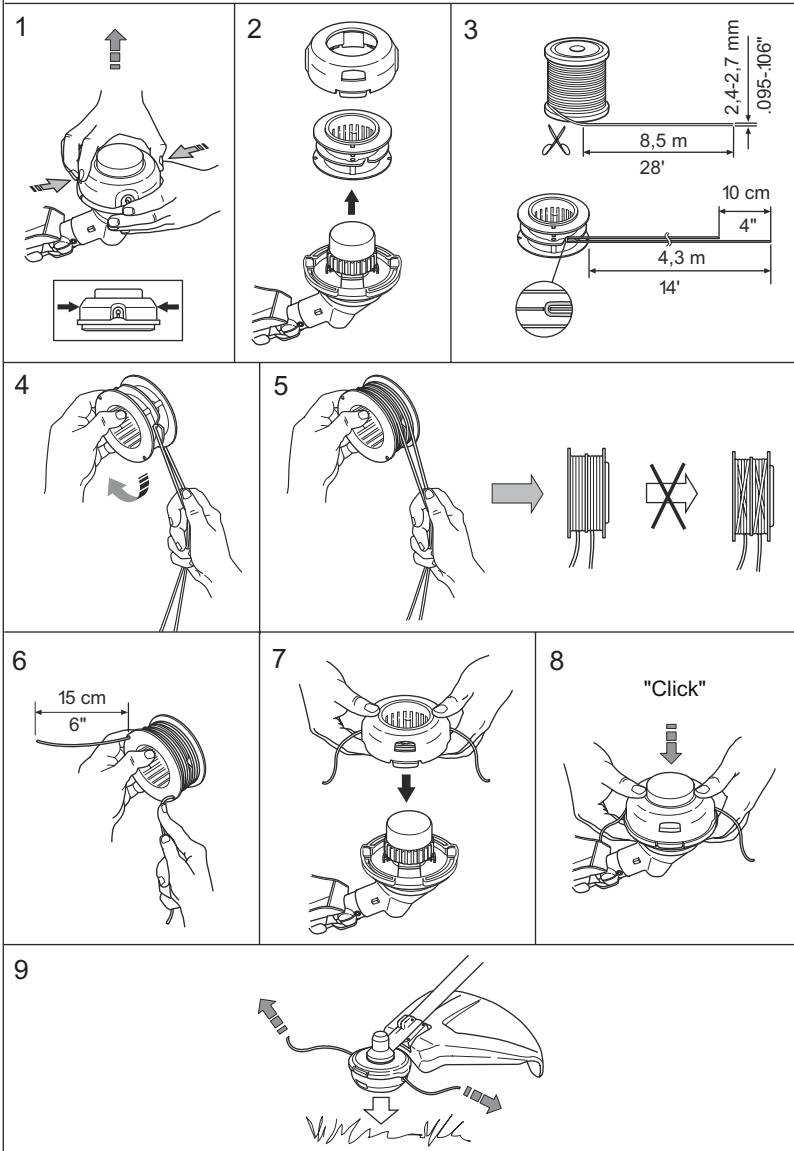



# Husqvarna®

[www.husqvarna.com](http://www.husqvarna.com)

Original instructions



1144076-26



2024-05-22